



Transport
Canada

Transports
Canada

TP 312E



(revised 03/2005)

**Air Navigation System
Requirements Branch**

AERODROME STANDARDS AND RECOMMENDED PRACTICES

**4th Edition
March 1993**

Canada



Ottawa, Ontario
K1A 0N8

Your file Votre référence

Our file Notre référence

A 5110 – 1 U / RDIMS # 1115893

March 2005

Mars 2005

Please find attached updated pages to TP 312 4th edition, which were affected by Corrigenda# 1 circulated as a pen and ink correction in March 1993.

Vous trouverez ci-joint les pages révisées du TP 312, 4^e édition, visées par la série de rectificatifs n^o 1 qui vous ont été communiqués en mars 1993 et que vous deviez apporter à la main.

Also included is Corrigenda# 2 to the same document which corrects a misprint to Figure 5-22.

Vous trouverez également ci-joint le rectificatif n^o 2 qui vient corriger une coquille relevée à la figure 5-22 du même document.

The provision of these revised pages is part of our overall objective to have a current, electronic version of TP 312 4th edition available online.

Nous vous envoyons ces pages révisées afin d'atteindre notre objectif global, qui est d'afficher sur Internet une version électronique à jour du TP 312, 4^e édition.

Directeur intérimaire
Aérodromes et Navigation aérienne

Tom R. Fudakowski
Acting Director
Aerodromes and Air Navigation

Enclosure

pièce jointe

Canada

INTENTIONALLY LEFT BLANK

**Aerodrome Standards and Recommended Practices
TP 312E**

Corrigendum No. 1

The initial issue of TP 312E, Aerodrome Standards and Recommended Practices, contains some errors which require the following pen and ink corrections:

1. Page (iv) Table of contents Section 5.3; revise 5.2.8 to read 5.3.8.
Section 5.4; revise "5.2.7" to read "5.4.7"
2. Page (vi) Table of contents Sub-section B.2.3; revise "15 m spacing" to read "7.5 m spacing".
Sub-section B.2.4; revise "7.5 m spacing" to read "30 m, 60 m spacing".
Sub-section B.2.5; revise "7.5 m spacing" to read "30 m, 60 m spacing".
3. Page 1-6 Para 1.2.1, last sentence; revise to read: "...shall rest with Transport Canada Aviation."
4. Page 3-12 Figure 3-1, bottom para; revise referance from 3.9.1.6 to 3.4.1.6.
5. Page 5-6 Figure 5-4; add the symbol \leq , as follows:
 - change "30m L₁ L₂" to read "30m \leq L₁ \geq L₂".
 - change "7.5 m a 15.m" to read "7.5 m \leq a \leq 15.m".
6. Page 5-15 Revise section number 5.2.14 to 5.2.15
7. Page 5-27 Table 5-3, Note (at bottom of table); revise "Figure 5-10" to read "Figure 5-14"
8. Page 5-31 Table 5-4, Note (at bottom of table); revise "Figure 5-10" to read "Figure 5-14"
9. Page 5-48 Revise paragraph number 5.3.12.2 to 5.3.12.3 Revise remaining paragraph numbers in each setion 5.3.12 consecutively to read paras 5.3.12.4 to 5.3.12.7
10. Page 7-3 Under "characteristics" revise paragraph number 7.3.1.5 to read 7.3.1.7.
Revise paragraph number 7.3.1.6 to read 7.3.1.8
11. Page 8-3 Revise the second paragraph number 8.1.2.2 to read 8.1.2.3
12. Page 8-5 Revise paragraph number 8.5.2.1 to read 8.4.2.1.
In paragraph number 8.5.1.1: revise "section 8.9" to read "sub-section 8.5.2" and revise paragraph number 8.5.1.17 to read 8.5.1.18.
Paragraph 8.5.1.5; revise "Table 8-3" to read "Table 8-2".

13. Page 8-6 Paragraph 8.5.1.14; replace “runway guard lights” with “stop bars and runway guard lights”.
14. Page C-1 Revise the second paragraph number C.1.1.3 to read C.1.1.4
15. Page C-6 Under “Frangibility and withstand” revise paragraph number C.1.3.3 to read C.1.3.4. Revise remaining paragraph numbers in section C.1.3 consecutively to read paras C.1.3.5 to C.1.3.10
16. Page C-7 Revise the second paragraph number C.3.2.8 to read C.3.2.9
17. Attachment A Page 4 Under “RUNWAY SURFACE EVENNESS”, second paragraph; revise 5.2 to read 4.2
18. Record entry of this corrigendum on page (ii)

- END -



TP 312E
Aerodrome Standards and Recommended Practices

Corrigendum No. 2

The initial issue of TP312E 4th edition, Aerodrome Standards and Recommended Practices, contains the following errors, which have been corrected as part of this Corrigendum:

1. Page 5-62 Pattern A taxi-holding position markings in Figure 5-22 were previously displayed in reverse.
2. Page 5-6 Figure 5-4, formula for spacing of displaced arrows amended to read $30\text{m} \leq L1 \geq L2$
3. Page 8-5 8.6.1.10 has been renumbered to 8.5.1.10

INTENTIONALLY LEFT BLANK

TABLE OF CONTENTS

	<i>Page</i>		<i>Page</i>
Abbreviations and Symbols, Manuals	(vii)	3.1.3 Strength of Runways	3-4
Manuals	(viii)	3.1.4 Surface of Runways	3-4
FOREWORD	(ix)	3.1.5 Runway Shoulders	3-5
		3.1.6 Runway Strips	3-5
		3.1.7 Runway End Safety Areas	3-8
		CHAPTER 1	
		GENERAL	
1.1 DEFINITIONS	1-1	3.2 CLEARWAYS	3-8
1.2 APPLICABILITY	1-6	3.2.1 Location of Clearways	3-8
1.3 REFERENCE CODE	1-7	3.2.2 Length of Clearways	3-8
		3.2.3 Width of Clearways	3-9
		3.2.4 Slopes on Clearways	3-9
		3.2.5 Objects on Clearways	3-9
		CHAPTER 2	
		AERODROME DATA	
2.1 GENERAL	2-1	3.3 STOPWAYS	3-9
2.1.1 Units of Measurement	2-1	3.3.1 Width of Stopways	3-9
2.2 GEOGRAPHIC DATA	2-1	3.3.2 Slopes on Stopways	3-10
2.2.1 Aerodrome Reference Point	2-1	3.3.3 Strength of Stopways	3-10
2.2.2 Geometric Centre	2-1	3.3.4 Surface of Stopways	3-10
2.2.3 Runway Threshold Coordinates	2-1	3.3.5 Objects on Stopways	3-10
2.2.4 Aerodrome and Runway Elevations	2-2	3.4 TAXIWAYS	3-11
2.2.5 Aerodrome Magnetic Variation	2-2	3.4.1 General	3-11
2.2.6 Aerodrome Reference Temperature	2-2	3.4.2 Slopes on Taxiways	3-13
2.2.7 Electronic Navigation Aids	2-2	3.4.3 Strength of Taxiways	3-14
2.3 AERODROME DIMENSIONS AND RELATED		3.4.4 Surface of Taxiways	3-14
INFORMATION	2-2	3.4.5 Rapid Exit Taxiways	3-14
2.3.1 General	2-2	3.4.6 Taxiways on Bridges	3-15
2.3.2 Declared Distances	2-3	3.4.7 Taxiway Shoulders	3-15
2.3.3 (not allocated)		3.4.8 Taxiway Strips	3-16
2.3.4 ICAO "Type A" Obstacle charts	2-4	3.5 HOLDING BAYS, TAXIHOLDING POSITIONS,	
2.4 STRENGTH OF PAVEMENTS	2-5	AND ROAD-HOLDING POSITIONS	3-16
2.4.1 General	2-5	3.5.1 Holding Bays	3-16
2.4.2 ACN-PCN Method of Reporting	2-5	3.5.2 Taxi-Holding Positions	3-17
2.5 CONDITION OF THE MOVEMENT AREA AND		3.5.3 Road-Holding Positions	3-17
RELATED FACILITIES	2-7	3.6 APRONS	3-18
2.5.1 General	2-7	3.6.1 General	3-18
2.5.2 Runway Surface Condition Reporting	2-7	3.6.2 Size of Aprons	3-18
2.5.3 Rescue and Fire Fighting	2-8	3.6.3 Strength of Aprons	3-18
		3.6.4 Slopes on Aprons	3-18
		3.6.5 Clearance Distances on Aprons and	
		Aircraft Stands	3-19
		3.6.6 Aircraft Stand Taxilane Minimum	
		Clearance Distances	3-19
		3.6.7 Isolated Aircraft Parking Position	3-19
		CHAPTER 3	
		PHYSICAL CHARACTERISTICS	
3.1 RUNWAYS	3-1	CHAPTER 4	
3.1.1 General	3-1	OBSTACLE RESTRICTION AND REMOVAL	
3.1.2 Slopes on Runways	3-3	4.1 OBSTACLE LIMITATION SURFACES	4-1
		4.1.1 Outer Surface	4-1
		4.1.2 Take-Off/Approach Surface	4-1

	<i>Page</i>	<i>Page</i>
CHAPTER 6		
VISUAL AIDS FOR DENOTING OBSTACLES		
6.1 OBJECTS TO BE MARKED AND/OR LIGHTED	6-1	
6.1.1 Objects on Movement Areas	6-1	
6.1.2 Objects on Runway Strips	6-1	
6.1.3 Other Objects	6-1	
6.2 MARKING OF OBJECTS	6-2	
6.2.1 Fixed Objects	6-2	
6.2.2 Mobile Objects	6-3	
6.3 LIGHTING OF OBJECTS	6-3	
6.3.1 Fixed Objects	6-3	
6.3.2 Mobile Objects	6-3	
CHAPTER 7		
VISUAL AIDS FOR DENOTING RESTRICTED USE AREAS		
7.1 CLOSED RUNWAYS AND TAXIWAYS OR PORTIONS THEREOF	7-1	
7.1.1 Closed Markings	7-1	
7.1.2 Lighting	7-2	
7.2 NON LOAD-BEARING SURFACES	7-2	
7.2.1 Taxi Side Stripe Marking	7-2	
7.3 PRE-THRESHOLD AREAS	7-3	
7.3.1 Chevron Marking	7-3	
7.4 UNSERVICEABLE AREAS	7-4	
7.4.1 Unserviceability Markers	7-4	
7.4.2 Unserviceability Lights	7-4	
CHAPTER 8		
EQUIPMENT INSTALLATIONS AND OPERATIONS		
8.1 ELECTRICAL SYSTEMS	8-1	
8.1.1 Secondary Power Supply	8-1	
– General	8-1	
– Visual Aids	8-1	
8.1.2 Circuit Design	8-3	
8.1.3 Standby Power Unit Operation	8-3	
8.2 (not allocated)		
8.3 MONITORING	8-3	
8.3.1 Visual Aids	8-3	
8.4 SECURITY	8-4	
8.4.1 Fencing	8-4	
8.4.2 Security Lighting	8-5	
8.5 OPERATION AND CONTROL OF AERODROME LIGHTING SYSTEMS	8-5	
8.5.1 General	8-5	
8.5.2 Aircraft Control of Aerodrome Lighting (ARCAL)	8-7	
8.6 SITING AND CONSTRUCTION OF EQUIPMENT AND INSTALLATIONS ON OPERATIONAL AREAS	8-9	
8.6.1 General	8-9	
8.7 AERODROME VEHICLE OPERATION	8-9	
8.7.1 General	8-9	
8.8 SURFACE MOVEMENT GUIDANCE AND CONTROL SYSTEMS	8-10	
8.8.1 General	8-10	
8.8.2 Visual Aids	8-11	
8.8.3 Non-visual Aids	8-11	
8.9 SIMULTANEOUS INTERSECTING RUNWAY OPERATIONS (SIRO)	8-12	
8.9.1 General	8-12	
CHAPTER 9		
EMERGENCY AND OTHER SERVICES		
9.1 AERODROME EMERGENCY PLANNING	9-1	
9.1.1 Emergency Response Plan	9-1	
9.1.2 Emergency Operations and Command Post	9-2	
9.1.3 Aerodrome Emergency Exercise	9-2	
9.2 (not allocated)		
9.3 DISABLED AIRCRAFT REMOVAL	9-3	
9.3.1 Disabled Aircraft Removal Plan	9-3	
9.3.2 Removal of Disabled Aircraft from Operational Areas	9-3	
9.4 MAINTENANCE	9-4	
9.4.1 General	9-4	
9.4.2 Pavements	9-4	
9.4.3 Visual Aids	9-5	
9.5 WILDLIFE REDUCTION HAZARD	9-7	
9.5.1 General	9-7	
9.6 APRON MANAGEMENT SERVICE	9-7	
9.6.1 General	9-7	
9.7 GROUND SERVICING OF AIRCRAFT	9-8	
9.7.1 General	9-8	

	<i>Page</i>
APPENDIX A	
AERONAUTICAL GROUND LIGHT AND SURFACE MARKING COLOURS	
A.1 (to be issued at a later date)	A-1

APPENDIX B	
AERONAUTICAL GROUND LIGHT CHARACTERISTICS	
B.1 APPROACH AND RUNWAY LIGHTS	B-1
B.1.1 Approach Centre Line Lights and Crossbars	B-1
B.1.2 Approach Side Row Lights	B-2
B.1.3 Threshold Lights	B-3
B.1.4 Wing Bar lights	B-4
B.1.5 Touchdown Zone Lights	B-5
B.1.6 Runway Centre line Lights (30 m spacing)	B-6
B.1.7 Runway Centre line Lights (15m spacing)	B-7
B.1.8 Runway Centre line Lights (7.5 m spacing)	B-8
B.1.9 Runway End Lights	B-9
B.1.10 Runway Edge Light (45 m runway width)	B-10
B.1.11 Runway Edge Lights (60 m runway width)	B-11
B.1.12 Common Requirements for approach and Runway Lights	B-12
B.2 TAXIWAY LIGHTS	B-14
B.2.1 Taxiway Centre Line Lights (15 m spacing) and Stop Bar Lights in Straight Sections Intended For Use in RVR Conditions Less Than a Value of 1400 ft (large offsets)	B-14
B.2.2 Taxiway Centre Line Lights (15 m spacing) and Stop Bar Lights in Straight Sections Intended For Use in RVR Conditions Less Than a Value of 1400 ft	B-15
B.2.3 Taxiway Centre Line Lights (7.5 m spacing) and Stop Bar Lights in Curved Sections Intended For Use in RVR Conditions Less Than a Value of 1400 ft	B-16
B.2.4 Taxiway Centre Line Lights (30 m, 60 m spacing) and Stop Bar Lights in Straight Sections Intended For Use in RVR Conditions of 1400 ft or greater	B-17
B.2.5 Taxiway Centre Line Lights (30 m, 60 m spacing) and Stop Bar Lights in Curved Sections Intended For Use in RVR Conditions of 1400 ft or	

greater	B-18
B.2.6 Runway Guard Lights (configuration A)	B-19
B.2.7 Collective Requirements for Taxiway Lights	B-20
B.3 VISUAL APPROACH SLOPE INDICATOR SYSTEMS	B-21
B.3.1 PAPI and APAPI	B-21

APPENDIX C	
AIRSIDE GUIDANCE SIGN DESIGN SPECIFICATIONS	
C.1 GENERAL REQUIREMENTS	C-1
C.1.1 Sign Face and Inscription Dimensions	C-1
C.1.2 Sign Character Size and Spacing	C-1
C.1.3 Sign Construction	C-6
C.2 RETROREFLECTIVE SIGNS	C-7
C.2.1 General	C-7
C.3 ILLUMINATED SIGNS	C-7
C.3.1 General	C-7
C.3.2 Internally Illuminated Signs	C-7
C.3.3 Fibreoptic Signs	C-8

ATTACHMENTS

ABBREVIATIONS and SYMBOLS

(used in Aerodrome Standards and Recommended Practices)

Abbreviations

AAE	Above aerodrome elevation
AAS	Airport Advisory Service
ACN	Aircraft classification number
ALR	Aircraft loading rating
APAPI	Abbreviated precision approach path indicator
aprx	Approximately
ARCAL	Aircraft radio control of aerodrome lighting
ARP	aerodrome reference point
ASDA	Accelerate stop distance available
ATF	Aerodrome traffic frequency
ATS	Air traffic services
C	Degrees Celsius
CAT I	Category I
CAT II	Category II
CAT III	Category III
CBR	California bearing ratio
cd	Candela
CIE	Commission Internationale de l'Éclairage
cm	Centimetre
DME	Distance measuring equipment
E	East
EWH	Eye to wheel height
FAA	Federal Aviation Administration (USA)
FOD	Foreign object damage
ft	Foot
GNSS	Global Navigation Satellite System
GPS	Global Positioning System
GS	Glideslope
HAA	Height above aerodrome
HIAL	High intensity approach lighting
ICAO	International Civil Aviation Organization
IFR	Instrument flight rules
ILS	Instrument landing system
IMC	Instrument meteorological conditions
JBI	James Brake Index
K	Degree Kelvin
kg	Kilogram
km/h	Kilometre per hour
km	Kilometre
kt	Knot
L	Litre
LDA	Landing distance available
m	Metre
M	Magnetic
MALSR	Medium intensity approach lighting system with runway alignment indicator lights
max	Maximum
MF	Mandatory frequency

Abbreviations

min	Minimum
MLS	Microwave landing system
mm	Millimetre
MN	Meganewton
MPa	Megapascal
MSL	Above mean sea level
N	North
NM	Nautical mile
NOTAM	Notices to airmen
NU	Not usable
OCA/H	Obstacle clearance altitude/height
ODALS	Omni-directional lighting system
OFZ	Obstacle free zone
OLS	Obstacle limitation surface
PAPI	Precision approach path indicator
PCN	Pavement classification number
PLR	Pavement load rating
RCR	Runway condition report
RESA	Runway end safety area
RILS	Runway identification lights
RSC	Runway surface condition
RVR	Runway visual range
S	South
secs	Seconds
SIRO	Simultaneous intersecting runway operations
T	True
TC	Transport Canada
TDZ	Touchdown zone
TDZE	Touchdown zone elevation
TDZL	Touchdown zone lighting
TODA	Take-off distance available
TORA	Take-off run available
TP	Transport Canada publication
VFR	Visual flight rules
VMC	Visual meteorological conditions
VOR	Very high frequency omnidirectional range
W	West

Symbols

°	Degrees
>	Greater than
<	Less than
-	Minus
'	Minute of arc
%	Percentage
±	Plus or minus
+	Plus
''	Seconds of arc

MANUALS

(related to the specifications of this document)

International Civil Aviation Organization (ICAO) Manuals

Aerodrome Design Manual (*ICAO Doc 9157*)

- Part 1 - Runways
- Part 2 - Taxiways, Aprons and Holding Bays
- Part 3 - Pavements
- Part 4 - Visual Aids
- Part 5 - Electrical Systems

Airport Planning Manual (*ICAO Doc 9184*)

- Part 1 - Master Planning
- Part 2 - Land Use and Environmental Control
- Part 3 - Guidelines for Consultant/Construction Services

Airport Services Manual (*ICAO Doc 9137*)

- Part 1 - Rescue and Fire Fighting
- Part 2 - Pavement Surface Conditions
- Part 3 - Bird Control and Reduction
- Part 4 - (*withdrawn*)
- Part 5 - Removal of Disabled Aircraft
- Part 6 - Control of Obstacles
- Part 7 - Airport Emergency Planning
- Part 8 - Airport Operational Services
- Part 9 - Airport Maintenance Practices

Manual of Surface Movement Guidance and Control Systems (SMGCS) (*ICAO Doc 9476*)

Air Traffic Services Planning Manual (*ICAO Doc 9426*)

The International Civil Aviation Organization (ICAO) manuals may be obtained from the:

Document Sales Unit
International Civil Aviation Organization
1000 Sherbrooke St. W
Montreal, Quebec
H3A 2R2
Tel: (514)285-6304

Note.— ICAO Manuals are available in English and French versions. Specify whether you require the English or French volume.

Transport Canada (Aviation) Manuals

- TP 382 – Standard Obstruction Markings
- TP 973 – Canadian Class 1 NOTAM Procedures
- TP 1247 – Land Use in the Vicinity of Airports
- TP 1490 – Manual of All Weather Operations
- TP 7775 – Procedures for the Certification of Aerodromes as Airports

The Transport Canada Aviation documents may be obtained from:

Transport Canada (AANDH)
Aeronautical Information Services
Ottawa, Ontario
K1A 0N8
Tel: (613)991-9970
Fax: (613)998-7416

Note. — Specify whether you require the English (E) or French(F) volume.

Transport Canada (Airports) Manuals

- TP 1801 – Airport Emergency Planning Manual
- TP 11465 – Airport Safety Programs Manual
- TP 779 - Operations and Maintenance Manual for Airport Pavements
- TP 2633 - Manual of Airport Traffic Directives for the Operation of Vehicles on Airport Movement Areas

The above Transport Canada Airports manuals may be obtained from:

Transport Canada (AKPRS)
Safety and Emergency Planning
Ottawa, Ontario
K1A 0N8
Tel: (613)990-3711
Fax: (613)957-4260

- TP 659 – Airports Winter Surface Maintenance Manual

The above Transport Canada Airports manual may be obtained from:

Transport Canada (AKPEM)
Safety and Technical Services
Ottawa, Ontario
K1A 0N8
Tel: (613)990-1341
Fax: (613)957-4260

INTENTIONALLY LEFT BLANK

FOREWORD

Application

The specifications contained in this manual are applicable to land airports which are certified pursuant to the Air Regulations Part III. Airports which were certified in accordance with the Standards and Recommended Practices contained in previous editions of this manual may, except where otherwise specified, maintain the airport in accordance with the specifications applicable at the time of certification.

Where the airport, portions of the airport or its facilities are rehabilitated, replaced, refurbished or improved, the specifications contained in this edition of the manual shall apply.

Status of manual components

This manual serves as the authoritative document for airport specifications, including physical characteristics, obstacle limitations surfaces, lighting, markers, marking and signs. It uses the ICAO phraseology of “standard” or “recommended practice” to identify specifications which are considered to have a direct impact on the safety of flight from those which effect only operational efficiency. These terms are defined as:

Standard: A standard includes any specification for physical characteristics, configuration, material, performance, personnel or procedure; the uniform application of which is recognized as necessary for the safety or regularity of air navigation and to which operators will conform. Standards, identified by the use of the verb “shall”, are mandatory for certification unless a deviation has been approved.

Recommended Practice: Any specification for physical characteristics, configuration, material, performance, personnel or procedure; the uniform application of which is recognized as desirable in the interest of safety, regularity or efficiency of air navigation, and to which operators will endeavour to conform. Specifications designated as

PRÉFACE

Emploi

Les spécifications contenues dans ce manuel s'appliquent aux aéroports certifiés selon la partie III du Règlement de l'air. Les aéroports certifiés suivant les Normes et pratique recommandées mentionnées dans les éditions précédentes du manuel peuvent, sauf indication contraire, être entretenus conformément aux spécifications en vigueur au moment de la certification.

Lorsque l'aéroport, des portions de l'aéroport ou des installations sont remis en service, remplacés, remis à neuf ou améliorés, les spécifications du présent manuel doivent être appliquées.

État des composantes du manuel

Le présent manuel sert de référence pour les spécifications d'aérodrome, y compris les caractéristiques physiques, les surfaces de limitation d'obstacles, le balisage lumineux, les balises, les marques et les panneaux. Il utilise la phraséologie de l'OACI “normes” ou “pratique recommandée”, pour distinguer les spécifications considérées comme ayant des conséquences directes sur la sécurité de vol de celles qui n'affectent que le rendement de l'exploitation. Les termes en question sont définis comme suit:

Norme: Une norme comprend toute spécification reliée aux caractéristiques physiques, à la configuration, au matériel, à la performance, au personnel ou à la procédure, dont l'application uniforme est considéré nécessaire à la sécurité ou à la régularité de la navigation aérienne, et à laquelle les exploitants se conformeront. Les normes, reconnaissables à la mention “**Norme**” et à l'emploi de “doit ou ”doivent” ou du futur simple, sont obligatoires pour la certification, à moins de dérogation.

Pratique recommandée: Il s'agit de toute spécification reliée aux caractéristiques physiques, à la configuration, au matériel, à la performance, au personnel ou à la procédure, dont l'application uniforme est considéré souhaitable dans l'intérêt de la sécurité, la régularité ou le rendement de la navigation aérienne. et à laquelle les exploitants

recommended practices are identified by the verb “should”.

Appendices, annexes, tables or figures, which are used to amplify or illustrate standards or recommended practices, are considered to form part of the main document and therefore have the same status as the primary text.

Notes and attachments comprise material supplementary to the Standards and Recommended Practices or are included as a guide to their application.

Some standards and recommended practices in this document incorporate, by reference, other specifications, standards and recommended practices such as Airport Authority Group Documents. In such cases, the text of these references becomes part of the TP 312, Standards and Recommended Practices.

Editorial practices

The following practices have been adhered to in order to indicate at a glance the status of each statement; Standards have been printed in light face gothic the status being indicated by the prefix **Standard**; Recommended Practices have been printed in light face gothic, the status being indicated by the prefix Recommendation. Notes have been printed in light face italics, the status being indicated by the prefix *Note*.

The following editorial practice has been followed in the writing of specification for Standards, the operative verb “shall” is used, and for Recommended Practices the operative verb “should” is used.

In some cases it has been recognized during the design of a specification that uniform application may not be possible. This has been recognized within the specification by the use of “if practicable”, “where physically practicable” or other similar wording. In such cases, the final authority as to the application of the specification concerned rests with the Certifying Authority.

essaient de se conformer. Les spécifications désignées comme pratiques recommandées se reconnaissent à l'emploi de “devrait” ou “devraient”.

Les appendices, les annexes, les tables et les chiffres utilisés pour développer ou illustrer les normes ou les pratiques recommandées sont considérés comme partie intégrante du document principal. Ils ont, par conséquent, le même statut que le texte primordial.

Les notes et suppléments contiennent des dispositions complémentaires à celles des normes et pratiques recommandées, ou des indications relatives à leur mise en application.

Des normes et des pratiques recommandées du présent document incluent, par référence, d'autres spécifications, normes et pratiques recommandées, comme les Documents du Groupe des Aéroports. Dans des cas pareils, le texte de ces références devient partie intégrante du TP 312, Normes et pratiques recommandées.

Disposition typographique

Afin de mettre en relief le caractère de chaque spécification, il a été décidé d'adopter la disposition typographique suivante: les *normes* sont imprimées en gothique et leur caractère est précisé par la mention **Norme**; les pratiques recommandées sont imprimées en gothique et leur caractère est précisé par la mention Recommendation; les notes sont imprimées en italique et leur caractère est précisé par la mention *Note*.

Il y a lieu de noter par ailleurs, que l'obligation exprimée par les normes a été rendue par l'emploi de “doit” ou “doivent”, ou du futur simple. Les recommandations sont rendues par l'expression “Il est recommandé” ou de l'emploi de “devrait” ou “devraient”.

Dans certains cas, il a été constaté durant l'élaboration des spécifications, qu'une application uniforme n'était pas toujours possible. Ceci fut considéré dans ces spécifications par l'emploi de “si praticable”, “lorsque matériellement praticable” ou d'autres expressions équivalentes. Dans pareils cas, l'autorité finale pour l'application des spécifications concernées demeure le détenteur des pouvoirs de certification.

Manual procurement

This manual is published in separate French language and English language editions:

Aérodromes - Normes et Pratiques
Recommandées - TP 312F

Aerodrome Standards and Recommended
Practices - TP 312E

Copies of both editions are available from:

Transport Canada
AANDHD
Ottawa, Ontario Canada
K1A 0N8

Tel : (613) 991-9970
Fax : (613) 998-7416

Acquisition du manuel

Ce manuel est publié en anglais et en français:

Aerodrome Standards and Recommended
Practices - TP 312E

Aérodromes - Normes et Pratiques
Recommandées - TP 312F

Des copies de ces deux éditions sont disponibles
de :

Transports Canada
AANDHD
Ottawa (Ontario) Canada
K1A 0N8

Tél : (613) 991-9970
Fax : (613) 998-7416

CHAPTER 1 GENERAL

Introductory Note.— This manual contains Standards and Recommended Practices (specifications) that prescribe the physical characteristics and obstacle limitation surfaces to be provided for at aerodromes, and certain facilities and technical services normally provided at an aerodrome. It is not intended that these specifications limit or regulate the operation of an aircraft.

To a great extent, the specifications for individual facilities detailed in this manual have been interrelated by a reference code system, described in this chapter, and by the designation of the type of runway for which they are to be provided, as specified in the definitions.

Evolving technologies in the fields of aircraft avionics, communications, navigation and surveillance may have a significant impact on future aerodrome operations. The combination of flight management systems, global navigation satellite systems and automatic dependent surveillance systems may be sufficiently accurate to permit instrument approaches to precision approach category I minima independent of ground based approach aids. Accordingly, aerodrome operators might wish to evaluate the impact of these evolving technologies as part of the aerodrome planning activities.

This document sets forth the minimum aerodrome specifications for aircraft which have the characteristics of those which are currently operating or for similar aircraft that are planned for introduction. Accordingly, any additional safeguards that might be considered appropriate to provide for more demanding aircraft are not taken into account. Such matters are left to the airport operator or the certifying authority to evaluate and take into account as necessary for each particular aerodrome.

It is to be noted that the specifications for precision approach runways categories II and III are only applicable to runways intended to be used by aeroplanes in code numbers 3 and 4.

1.1 DEFINITIONS

When the following terms are used in this Manual they have the following meanings:

Aerodrome. Any area of land, water (including frozen surface thereof) or other supporting surface used or designed, prepared, equipped or set apart for use either in whole or in part for the arrival and departure, movement or servicing of aircraft and includes any building, installations and equipment in connection therewith.

Aerodrome beacon. Aeronautical beacon used to indicate the location of an aerodrome from the air.

Aerodrome elevation. The elevation of the highest point of the landing area.

Aerodrome reference point. The designated point or points on an aerodrome normally located at or near the geometric centre of the runway complex that establishes the locus of the radius or radii of the outer surface (as defined in a Zoning Regulation).

Aerodrome reference temperature. The monthly mean of the maximum daily temperature for the hottest month of the year (the hottest month being that which has the highest monthly mean temperature).

Aeronautical beacon. An aeronautical ground light visible at all azimuths, either continuously or intermittently, to designate a particular point on the surface of the earth.

Aeronautical ground light. Any light specially provided as an aid to air navigation, other than a light displayed on an aircraft.

Aeronautical Study. An investigation of a problem concerned with some phase of flight, and aimed at identifying possible solutions and selecting the one most acceptable from the point of view of flight safety.

Aeroplane. A power-driven heavier-than-air aircraft deriving its lift in flight from aerodynamic reactions on surfaces that remain fixed under given conditions of flight.

Aeroplane reference field length. The minimum field length required for take-off at maximum certificated take-off mass, sea level, standard atmospheric conditions, still air and zero runway slope, as shown in the appropriate aeroplane flight manual prescribed by the certifying authority or equivalent data from the aeroplane manufacturer. Field length means balanced field length for aeroplanes, if applicable, or take-off distance in other cases.

Aircraft. A machine capable of deriving support in the atmosphere from the reactions of the air

Aircraft stand. A designated area on an apron intended to be used for parking an aircraft.

Aircraft stand taxilane. A portion of an apron designated as a taxiway and intended to provide access to aircraft stands only.

Airport. An aerodrome for which, under Part III of the Air Regulations, an airport certificate has been issued by the Minister.

Airport operator. The holder of an airport certificate, or the person in charge of such airport, whether, an employee, agent or representative.

Airport zoning regulations. A regulation respecting a given airport pursuant to section 5.4 of the aeronautics Act made by the Governor in Council.

Airside. The movement area of an aerodrome, adjacent terrain and buildings or portions thereof, access to which is controlled.

Apron. That part of an aerodrome, other than the manoeuvring area, intended to accommodate the loading and unloading of passengers and cargo, the refuelling, servicing, maintenance and parking of aircraft, and any movement of aircraft, vehicles and pedestrians necessary for such purposes.

Apron management service. A service provided to regulate the activities and the movement of aircraft and vehicles on an apron.

Arctic Airport. An airport located in the Yukon Territory or in the Northwest Territories.

Average Luminous Intensity. A theoretical intensity calculated so that the luminous intensity produced by a light unit, within the specified beam dimensions, nowhere falls to less than 50 per cent or rises to more than 150 per cent of the average value.

Balanced Field Length. A field length where the distance to accelerate and stop is equal to the take-off distance of an aeroplane experiencing an engine failure at the critical engine failure recognition speed (V_1).

Barrette. Three or more aeronautical ground lights closely spaced in a transverse line so that from a distance they appear as a short bar of light.

Bearing strength. The structural ability of a surface to support loads imposed by aircraft.

Candela. The luminous intensity as defined in the International System of Units (SI).

Capacitor discharge light. A lamp in which high-intensity flashes of extremely short duration are produced by the discharge of electricity at high voltage through a gas enclosed in a tube.

Certifying authority. The Regional Director Air Navigation System Requirements.

Circling procedure. Visual manoeuvring required after completing an instrument approach procedure.

Clearway. A defined rectangular area on the ground or water under the control of the appropriate authority, selected or prepared as a suitable area over which an aeroplane may make a portion of its initial climb to a specified height.

Critical aeroplane. The aeroplane or aeroplanes identified from among the aeroplanes the aerodrome is intended to serve as having the most demanding operational requirements with respect to the determination of movement area dimensions, pavement bearing strength and other physical characteristics in the design of aerodromes.

Declared distances.

- a) Take-off run available (TORA). The length of runway declared available and suitable for the ground run of an aeroplane taking off.
- b) Take-off distance available (TODA). The length of the take-off run available plus the length of the clearway, if provided.
- c) Accelerate-stop distance available (ASDA). The length of the take-off run available plus the length of the stopway, if provided.
- d) Landing distance available (LDA). The length of runway which is declared available and suitable for the ground run of an aeroplane landing.

Dependent parallel approaches.

Simultaneous approaches to parallel or near-parallel instrument runways where radar separation minima between aircraft on adjacent extended runway centre lines are prescribed.

Displaced threshold. A threshold not located at the extremity of a runway. Displaced thresholds are used when an obstacle in the final approach area intrudes into the specific obstruction clearance surfaces. Displacing the threshold provides the required obstacle free slope. The declared landing distance (LDA) which assumes a specified obstacle clearance plane is therefore measured from the displaced threshold; however there is no restriction to an aircraft actually landing on the usable runway prior to the displaced threshold. This portion of the runway is also available for take-off or rollout.

Effective intensity. The effective intensity of a flashing light is equal to the intensity of a fixed light of the same colour which will produce the same visual range under identical conditions of observation.

Elevation. The vertical distance of a point or a level, on or affixed to the surface of the earth, measured from mean sea level.

Fixed light. A light having constant luminous intensity when observed from a fixed point.

Frangible object. An object of low mass designed to break, distort or yield on impact so as to present the minimum hazard to aircraft.

Note.— Guidance on design for frangibility is contained in the ICAO Aerodrome Design Manual, Part 6.

Geometric centre. The geographical coordinates of the centre of the runway complex that locates the aerodrome for charting purposes. It is determined by the mean of the latitudes of the furthest north runway threshold and furthest south runway threshold and the mean of the longitudes of the furthest east runway threshold and furthest west runway threshold.

Hazard beacon. An aeronautical beacon used to designate danger to air navigation.

Holding bay. A defined area where aircraft can be held, or bypassed, to facilitate efficient surface movement of aircraft.

Independent parallel approaches.

Simultaneous approaches to parallel or near-parallel instrument runways where radar separation minima between aircraft on adjacent extended runway centre lines are not prescribed.

Independent parallel departures.

Simultaneous departures from parallel or near-parallel instrument runways.

Instrument Approach Procedure. A series of predetermined manoeuvres by reference to flight instruments for the orderly transfer of an aircraft from the beginning of the initial approach to a landing, or to a point from which a landing may be made.

Instrument Meteorological Conditions (IMC).

Meteorological conditions expressed in terms of visibility, distance from cloud, and ceiling less than the minima specified for visual meteorological conditions.

Instrument runway. One of the following types of runways intended for the operation of aircraft using instrument approach procedures:

- a) Non-precision approach runway. An instrument runway served by visual aids and a non-visual aid providing at least directional guidance adequate for a straight-in approach.
- b) Precision approach runway, category I. An instrument runway served by ILS or MLS and visual aids intended for operations down to

200 ft (60 m) decision height and down to an RVR of the order of 2600 ft (800 m).

- c) Precision approach runway, category II. An instrument runways served by ILS or MLS and visual aids intended for operations down to 100 ft (30 m) decision height and down to an RVR of the order of 1400 ft (400 m).
- d) Precision approach runway, category III. An instrument runway served by ILS or MLS to and along the surface of the runway and:
 - A - intended for operations down to an RVR of the order of 600 ft (200 m) (no decision height being applicable) using visual aids during the final phase of landing;
 - B - intended for operations down to an RVR of the order of 150 ft (50 m) (no decision height being applicable) using visual aids for taxiing;
 - C - intended for operations without reliance on visual reference for landing or taxiing.

Note.— Visual aids need not necessarily be matched to the scale of non-visual aids provided. The criterion for the selection of visual aids is the conditions in which operations are intended to be conducted.

International Airport. An airport designated by Transport Canada to support international commercial air transport and listed as such in the ICAO Air Navigation Plan - North Atlantic, North American, and Pacific Regions (ICAO Doc 8755/13).

Landing area. That part of a movement area intended for the landing or take-off of aircraft.

Light failure. A light shall be considered to have failed when for any reason the average intensity determined using the specified angles of beam elevation, toe-in and spread falls below 50 per cent of the specified average intensity.

Lighting system reliability. The probability that the complete installation operates within the specified tolerances and that the system is operationally usable.

Manoeuvring area. That part of an aerodrome to be used for the take-off, landing and taxiing of

aircraft, excluding aprons.

Marker. An object displayed above ground level in order to indicate an obstacle or delineate a boundary.

Marking. A symbol or group of symbols displayed on the surface of the movement area in order to convey aeronautical information.

Movement area. That part of an aerodrome to be used for the take-off, landing and taxiing of aircraft, consisting of the manoeuvring area and the apron(s).

Near-parallel runways. Non-intersecting runways whose extended centre lines have an angle of convergence/divergence of 15 degrees or less.

Night. The period beginning one half-hour after sunset and ending one half-hour before sunrise and, in respect of any place where the sun does not rise or set daily, the period during which the centre of the sun's disc is more than six degrees below the horizon.

Non-instrument runway. A runway intended for the operation of aircraft using visual approach procedures.

Obstacle. All fixed (whether temporary or permanent) and mobile objects, or parts thereof, that are located on an area intended for the surface movement of aircraft or that extend above a defined surface intended to protect aircraft in flight.

Obstacle free zone (OFZ). The airspace above the approach surface, inner transitional surfaces, and that portion of the strip bounded by these surfaces, which is not penetrated by any fixed obstacle other than a low-mass and frangibly mounted one required for air navigation purposes.

Obstacle Limitation Surface (OLS). A surface that establishes the limit to which objects may project into the airspace associated with an aerodrome so that aircraft operations at the aerodrome may be conducted safely. Obstacle limitation surfaces consist of the following:

- a) Outer surface. A surface located in a horizontal plane above an aerodrome and its environs.

- b) Take-off/Approach surface. An inclined plane beyond the end of a runway and preceding the threshold of a runway.
- c) Transitional surface. A complex surface along the side of the strip and part of the side of the approach surface, that slopes upwards and outwards to the outer surface, when provided.

Pavement classification number (PCN). A number expressing the bearing strength of a pavement for unrestricted operations.

Precision approach runway, see Instrument runway.

Primary runway(s). Runway(s) used in preference to others whenever conditions permit.

Road. An established surface route on the movement area meant for the exclusive use of vehicles.

Road-holding position. A designated position at which vehicles may be required to hold.

Runway. A defined rectangular area on a land aerodrome prepared for the landing and take-off of aircraft.

Runway end safety area (RESA). An area symmetrical about the extended runway centre line and adjacent to the end of the strip primarily intended to reduce the risk of damage to an aeroplane undershooting or overrunning the runway.

Runway guard lights. A light system intended to caution pilots or vehicle drivers that they are about to enter an active runway.

Runway strip. A defined area including the runway and stopway, if provided, intended:

- a) to reduce the risk of damage to aircraft running off a runway; and
- b) to protect aircraft flying over it during take-off or landing operations.

Runway visual range (RVR). The range over which the pilot of an aircraft on the centre line of a runway can see the runway surface markings or the lights delineating the runway or identifying its centre line.

Secondary runway. The runway(s) designed to serve less critical aeroplanes and not necessarily sufficient for all aeroplanes which the primary runway is intended to serve and is provided to take account of the effect of particular winds of high velocity.

Segregated parallel operations. Simultaneous operations on parallel or near-parallel instrument runways in which one runway is used exclusively for approaches and the other runway is used exclusively for departures.

Shielding. A situation which permits the practice whereby an obstacle may be unmarked in spite of other adjacent dominant marked obstacles of equal height; it follows that an aircraft whose path of flight would avoid the dominant obstacle would as a result fly over the shielded obstacle without risk of collision.

Shoulder. An area adjacent to the edge of a pavement so prepared as to provide a transition between the pavement and the adjacent surface.

Sight distance. The maximum distance at a specified height above the pavement an object placed above the pavement at the same or other specified height can be seen.

Slush. Water-saturated snow which with a heel-and-toe slapdown motion against the ground will be displaced with a splatter; specific gravity: 0.5 up to 0.8.

Note.— Combinations of ice, snow and/or standing water may, especially when rain, rain and snow, or snow is falling, produce substances with specific gravities in excess of 0.8. These substances, due to their high water/ice content, will have a transparent rather than a cloudy appearance and, at the higher specific gravities, will be readily distinguishable from slush.

Snow (on the ground).

- a) Dry snow. Snow which can be blown if loose or, if compacted by hand, will fall apart again upon release; specific gravity: up to but not including 0.35.
- b) Wet snow. Snow which, if compacted by hand, will stick together and tend to or form a snowball; specific gravity: 0.35 up to but not including 0.5.

c) **Compacted snow.** Snow which has been compressed into a solid mass that resists further compression and will hold together or break up into lumps if picked up; specific gravity: 0.5 and over.

Stopway. A defined rectangular area on the ground at the end of take-off run available prepared as a suitable area in which an aircraft can be stopped in the case of an abandoned take-off.

Take-off runway. A runway intended for take-off only.

Taxi-holding position. A designated position at which taxiing aircraft and vehicles may be required to hold in order to provide adequate clearance from a runway.

Taxiway. A defined path on a land aerodrome established for the taxiing of aircraft and intended to provide a link between one part of the aerodrome and another, including:

- a) **Apron taxiway.** A portion of a taxiway system located on an apron and intended to provide a through taxi route across the apron.
- b) **Rapid exit taxiway.** A taxiway connected to a runway at an acute angle and designed to allow landing aeroplanes to turn off at higher speeds than are achieved on other exit taxiways thereby minimizing runway occupancy times.

Taxiway intersection. A junction of two or more taxiways.

Taxiway strip. An area including a taxiway intended to protect an aircraft operating on the taxiway and to reduce the risk of damage to an aircraft accidentally running off the taxiway.

Threshold. The beginning of that portion of the runway usable for landing.

Touchdown zone. The portion of a runway, beyond the threshold, where it is intended landing aeroplanes first contact the runway.

Traffic density. The relative degree of aircraft movements at an aerodrome determined from the number of movements per hour at the mean busy hour and classified as follows:

- a) **Light.** Not greater than 15 movements per runway or less than 20 total aerodrome movements;
- b) **Medium.** 16 to 25 movements per runway or between 20 to 35 total aerodrome movements; and
- c) **Heavy.** 26 or more movements per runway or more than 35 total aerodrome movements.

Transverse slope. The slope of a runway or a strip measured perpendicular to the runway centre line.

Usability factor. The percentage of time during which the use of a runway or system of runways is not restricted because of the cross-wind component.

Note.— Cross-wind component means the surface wind component at right angles to the runway centre line.

Visual meteorological conditions (VMC). Meteorological conditions expressed in terms of visibility, distance from cloud, and ceiling, equal to or better than specified minima.

1.2 APPLICABILITY

1.2.1 Standard.— The interpretation of some of the specifications in this manual expressly requires the exercising of discretion, the taking of a decision or the performance of a function by the appropriate authority. In other specifications, the expression appropriate authority does not actually appear although its inclusion is implied. In both cases, the responsibility for whatever determination or action is necessary shall rest with Transport Canada Aviation.

1.2.2 Standard.— The specifications, unless otherwise indicated in a particular context, shall apply to all land airports certified in accordance with Air Regulation Part III. The specifications of TP 312, Chapter 3 shall apply only to land aerodromes. The specifications in this volume shall apply, where appropriate, to heliports but shall not apply to stolports nor water airports.

1.2.3 Standard.— Wherever a colour is referred to in this Document, the specifications for that colour given in Appendix 1 shall apply.

1.3 REFERENCE CODE

Introductory Note.— The intent of the reference code is to provide a simple method for interrelating the numerous specifications concerning the characteristics of aerodromes so as to provide a series of aerodrome facilities that are suitable for the aeroplanes that are intended to operate at the aerodrome. The code is not intended to be used for determining runway length or pavement strength requirements. The code is composed of two elements which are related to the aeroplane performance characteristics and dimensions. Element 1 is a number based on the aeroplane reference field length and element 2 is a letter based on the aeroplane wing span and outer main gear wheel span. A particular specification is related to the more appropriate of the two elements of the code or to an appropriate combination of the two code elements. The code letter or number within an element selected for design proposes is related to

the critical aeroplane characteristics for which the facility is provided. When applying TP 312, the aeroplanes which the aerodrome is intended to serve are first identified and then the two elements of the code.

1.3.1 Standard.— An aerodrome reference code (code number and letter) which is selected for aerodrome planning purposes shall be determined in accordance with the characteristics of the aeroplane for which an aerodrome facility is intended.

1.3.2 Standard.— The aerodrome reference code numbers and letters shall have the meanings assigned to them in Table 1-1.

1.3.3 Standard.— The code number for element 1 shall be determined from Table 1-1, column 1, selecting the code number corresponding to the highest value of the aeroplane reference field lengths of the aeroplanes for which the runway is intended.

Note.— The determination of the aeroplane reference field length is solely for the selection of a code number and is not intended to influence the actual runway length provided.

Table 1-1. Aerodrome reference code (see 1.3.2 to 1.3.4)

Code element 1		Code element 2		
Code number	Aeroplane reference field length	Code letter	Wing span	Outer main gear wheel span ^a
	(1)		(2)	(3)
1	Less than 800 m	A	Up to but not including 15 m	up to but not including 4.5 m
2	800 m up to but not including 1200 m	B	15 m up to but not including 24 m	4.5 m up to but not including 6 m
3	1200 m up to but not including 1800 m	C	24 m up to but not including 36 m	6 m up to but not including 9 m
4	1800 m and over	D	36 m up to but not including 52 m	9 m up to but not including 14 m
		E	52 m up to but not including 65 m	9 m up to but not including 14 m

^a. Distance between the outside edges of the main gear wheels.

1.3.4 Standard.— The code letter for element 2 shall be determined from Table 1-1, column 3, by selecting the code letter which corresponds to the greatest wing span, or the greatest outer main gear wing span, whichever gives the more demanding code letter of the aeroplanes for which the facility is intended.

Note.— *Guidance to assist the appropriate authority in determining the aerodrome reference code is given in the ICAO Aerodrome Design Manual, Part 1 and 2.*

CHAPTER 2. AERODROME DATA

Introductory Note.— This chapter contains specifications relating to the provision of data about aerodromes to be determined and recorded in the Aerodrome Operation Manual and where specified, reported to the regional Aeronautical Information Service.

2.1 GENERAL

2.1.1 UNITS OF MEASUREMENT

2.1.1.1 Standard.— Except as specified, elevations shall be given to the nearest foot (0.5 meter).

2.1.1.2 Standard.— Except as specified, linear dimensions shall be given to the nearest one-half metre.

2.1.1.3 Standard.— Except as specified, geographic coordinates shall be given in latitude and longitude to the nearest second.

2.1.1.4 Standard.— Geographic coordinates shall be measured in accordance with the NAD 83 reference datum.

2.1.1.5 Standard.— Except as specified, bearings shall be given to the nearest degree.

2.1.1.6 Recommendation.— Whenever possible, bearings should be given to the nearest 1/10 degree.

2.2 GEOGRAPHIC DATA

2.2.1 AERODROME REFERENCE POINT

2.2.1.1 Standard.— An aerodrome reference point shall be established for an aerodrome where an outer surface is established.

2.2.1.2 Standard.— The aerodrome reference point shall be located near the initial or planned geometric centre of the aerodrome and shall normally remain where first established.

Note.— Large or complex aerodromes may require more than one reference point to adequately define an outer surface.

2.2.2 GEOMETRIC CENTRE

2.2.2.1 Standard.— The geometric centre shall be determined for an aerodrome to the nearest 1/10 second.

2.2.2.2 Standard.— The geometric centre shall be redetermined if an aerodrome changes its physical characteristics by new runway construction, a runway closure, or altering the length of an existing runway.

2.2.3 RUNWAY THRESHOLD COORDINATES

2.2.3.1 Standard.— The geographic coordinates of the runway threshold at the centre line shall be determined to the nearest 1/10th of a second and given for each instrument runway.

2.2.3.2 Standard.— Where the threshold of an instrument runway has been permanently displaced, the coordinates of the displaced threshold at the centre line as well as the threshold at the runway extremity (defined by the beginning of the full strength pavement suitable for aircraft use) shall be determined and given to the nearest 1/10th of a second.

2.2.3.3 Recommendation.— The geographic coordinates of the runway threshold at the centreline should be determined to the nearest 1/10th of a second and given for each non-instrument runway.

2.2.3.4 Recommendation.— Where the threshold of a non-instrument runway has been permanently displaced, the coordinates of the

displaced threshold at the centre line as well as the threshold at the runway extremity should be determined and given to the nearest 1/10th of a second.

2.2.3.5 Standard.— The geographic coordinates of the runway end at the centre line shall be determined to the nearest 1/10th of a second and given for each instrument runway.

2.2.3.6 Recommendation.— The geographic coordinates of the runway end at the centreline should be determined to the nearest 1/10th of a second and given for each non-instrument runway.

Note.— *It is preferable that the runway threshold and end coordinates be measured and reported to the nearest 1/100 second.*

2.2.4 AERODROME and RUNWAY ELEVATIONS

2.2.4.1 Standard.— The aerodrome elevation shall be measured and given.

2.2.4.2 Standard.— For each instrument runway, the elevation of each threshold and any significant high or low points along the runway shall be measured and given.

2.2.4.3 Standard.— For each precision approach runway, the highest elevation within 915 m beyond the landing threshold shall be measured and given.

2.2.5 AERODROME MAGNETIC VARIATION

2.2.5.1 Standard.— The magnetic variation for the aerodrome geometric centre shall be determined and given to the nearest degree from magnetic north.

2.2.6 AERODROME REFERENCE TEMPERATURE

2.2.6.1 Standard.— An aerodrome reference temperature shall be determined for an aerodrome in degrees Celsius.

2.2.6.2 Recommendation.— The aerodrome reference temperature should be the monthly mean of the daily maximum temperatures for the hottest month of the year (the hottest month being that which has the highest monthly mean temperature). This temperature should be averaged over a period of at least eight years.

2.2.7 ELECTRONIC NAVIGATION AIDS

2.2.7.1 Standard.— Where electronic navigation aids are installed on an aerodrome, the following information shall be determined and given:

- a) The geographic coordinates of the antenna or radiating centre to the nearest 1/10 second;
- b) the elevation of the antenna or radiating centre; and
- c) the bearing of any unidirectional navigation signal (eg. ILS localizer course).

2.3 AERODROME DIMENSIONS AND RELATED INFORMATION

2.3.1 GENERAL

2.3.1.1 Standard.— The following data shall be measured or described, as appropriate, for each facility provided on an aerodrome:

- a) runway - true bearing, designation number, length, width, displaced threshold location, slope, surface type, and type of runway;
- b) runway strip, runway end safety area, and stopway length, width, and surface type.
- c) taxiway - designation, width, surface type;
- d) apron - surface type, aircraft stands;
- e) clearway - length, ground profile;
- f) significant obstacles on and in the vicinity of the aerodrome - location, top elevation to the

- nearest (next higher) foot, type;
- g) visual aids for approach procedures, marking and lighting of runways, taxiways and aprons, other visual guidance and control aids on taxiways and aprons, including taxi-holding positions and stopbars;
- h) location and radio frequency of any VOR aerodrome checkpoint; and
- i) location and designation of standard taxi-routes.

- b) take-off distance available;
- c) accelerate-stop distance available; and
- d) landing distance available.

2.3.2.2 Recommendation.— The following distances should be calculated for each non-instrument runway where the code number is 1 or 2:

2.3.1.2 Standard.— The geographical coordinates of each aircraft stand shall be measured and given to at least one-tenth of a minute.

- a) take-off run available;
- b) take-off distance available;
- c) accelerate-stop distance available; and
- d) landing distance available.

2.3.2 DECLARED DISTANCES

Units of measurement

Application

2.3.2.3 Standard.— The calculation and reporting of declared distances shall be to the nearest foot.

2.3.2.1 Standard.— The following distances shall be calculated for each runway where the code number is 3 or 4 and for each instrument runway where the code number is 1 or 2:

Calculation of declared distances

- a) take-off run available;

2.3.2.4 Standard.— The calculation of declared distances shall be as illustrated in Figure 2-1.

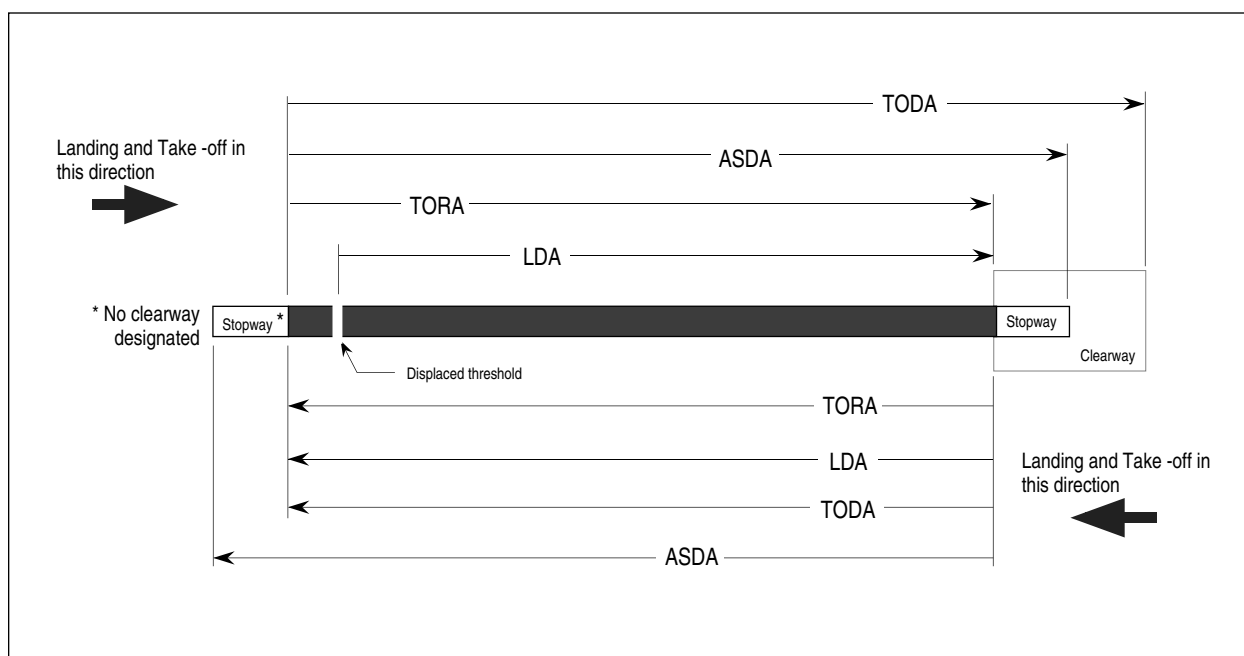

Figure 2-1. Illustration of Declared Distances

2.3.2.5 Recommendation.— Where a runway is not provided with a stopway or clearway and the threshold is located at the extremity of the runway, the declared distances should be equal to the length of the runway.

2.3.2.6 Standard.— Where a runway is provided with a clearway, then the Take-off Distance Available shall include the length of the clearway as shown in Figure 2-1.

2.3.2.7 Standard.— Where a runway is provided with a stopway, then the Accelerate-stop Distance Available shall include the length of the stopway as shown in Figure 2-1.

2.3.2.8 Standard.— Where a runway has a displaced threshold, the Landing Distance Available shall be reduced by the distance between the displaced threshold and the extremity of the runway as shown in Figure 2-1.

Note.— A displaced threshold affects only the LDA for approaches made to that runway. The declared distances for the reciprocal runway remain unaffected.

2.3.3 NOT ALLOCATED

2.3.4 ICAO “TYPE A” OBSTACLE CHARTS

Application

2.3.4.1 Standard.— Information required to compile ICAO Type A obstacle charts shall be provided to the Certifying Authority for all runways identified in the ICAO Regional Air Navigation Plan at an International Airport.

2.3.4.2 Standard.— The following information shall be provided for each runway:

- a) runway designation, true bearing, length, width, and surface type;
- b) length and width of the clearway, if provided;
- c) dimensions of the take-off flight path area;
- d) runway threshold and departure end elevations;

- e) location, height above mean sea level, and nature of objects within the take-off flight path area identified as obstacles;
- f) the date the obstacle survey was completed.

Note.— Subsequent reports need only contain the results of the obstacle survey and any other items of information which may have changed.

2.3.4.3 Standard.— Any new activity resulting in a change to any of the items required in 2.3.4.2 shall be reported to the Certifying Authority.

Requirement for obstacle survey

2.3.4.4 Standard.— Obstacle information shall be determined by a survey of the take-off flight path area. Except as specified in 2.3.4.5, the survey shall be repeated at a frequency approved by the Certifying Authority upon consideration of the level of building activity in the runway departure area and shall not exceed 5 years between surveys.

2.3.4.5 Standard.— A survey shall not be required if it can be ascertained that there are no new obstacles in the take-off flight path area and a report is made to the Certifying Authority to this effect.

Take-off flight path area

2.3.4.6 Standard.— The take-off flight path area shall consist of a quadrilateral area on the surface of the earth lying directly below, and symmetrically disposed about, the take-off flight path. The area shall commence at the end of the area declared suitable for take-off (ie. at the end of the runway or clearway as appropriate) and extend to the point beyond which no significant obstacles exist or to a distance of 10.0 km whichever is the lesser. The width at the point of origin shall be 180 m and increase at the rate of 0.25D to a maximum of 1800 m, where D is the distance from the point of origin.

Obstacles

2.3.4.7 Standard.— Objects in the take-off flight path area which project above a plane surface having a 1.2% slope and having a common origin with the take-off flight path area

shall be regarded as obstacles. Mobile obstacles such as boats, trains, trucks, etc. which may project above the 1.2% slope shall be considered obstacles. As a minimum, 4.3 m shall be allowed above the crown of a road and for a railway, 6 m above the top of the rails. The height to be allowed above a waterway, river, canal, etc. shall be established by Aeronautical Study.

2.4 STRENGTH OF PAVEMENTS

2.4.1 GENERAL

Application

2.4.1.1 Standard.— The bearing strength of a pavement shall be determined.

2.4.1.2 Standard.— The bearing strength of a pavement at an International Airport intended for aircraft of apron (ramp) mass greater than 5700 kg shall be made available using the aircraft classification number - pavement classification number (ACN-PCN) method by reporting all of the following information:

- a) the pavement classification number (PCN);
- b) pavement type for ACN-PCN determination;
- c) subgrade strength category;
- d) maximum allowable tire pressure category or maximum allowable tire pressure value; and
- e) evaluation method.

2.4.1.3 Recommendation.— The bearing strength of a pavement intended for aircraft of apron (ramp) mass greater than 5700 kg should be made available using the aircraft classification number - pavement classification number (ACN-PCN) method by reporting all of the following information:

- a) the pavement classification number (PCN);
- b) pavement type for ACN-PCN determination;
- c) subgrade strength category;

- d) maximum allowable tire pressure category or maximum allowable tire pressure value; and
- e) evaluation method.

Note. — If necessary, PCNs may be published to an accuracy of one-tenth of a whole number.

2.4.1.4 Recommendation.— The bearing strength of a pavement intended for aircraft of apron (ramp) mass equal to or less than 5700 kg should be made available by reporting the following information:

- a) maximum allowable aircraft mass; and
- b) maximum allowable tire pressure (eg. 4000 kg/0.50 MPa).

2.4.2 ACN-PCN method of reporting

Note.— The ACN-PCN method is meant only for publication of pavement strength data. It is not intended for design or evaluation of pavements.

2.4.2.1 Standard.— The pavement classification number (PCN) reported shall indicate that an aircraft with an aircraft classification number (ACN) equal to or less than the reported PCN can operate on the pavement subject to any limitation on the tire pressure, or aircraft all-up mass for specified aircraft type(s).

Note 1.— Different PCNs may be reported if the strength of the pavement is subject to significant seasonal variation.

Note 2.— The ACN of an aircraft is determined in accordance with the standard procedures associated with the ACN-PCN method.

Note 3.— The standard procedures for determining the ACN of an aircraft are given in the *Aerodrome Design Manual, Part 3*. For convenience several aircraft types currently in use have been evaluated on rigid and flexible pavements founded on the four subgrade categories in Table 2-1 and the results tabulated in that manual.

Table 2-1. Pavement Classification Number (PCN) Reporting codes

Pavement type for ACN-PCN determination:	<u>Codes</u>
Rigid pavement	R
Flexible pavement	F
<i>Note.— If the actual construction is composite or nonstandard, include a note to that effect (see example 2 below).</i>	
Subgrade strength category:	
<u>High strength</u> : characterized by $K=150 \text{ MN/m}^3$ and representing all K values above 120 MN/m^3 for rigid pavements, and by $\text{CBR}=15$ and representing all CBR values above 13 for flexible pavements.	A
<u>Medium strength</u> : characterized by $K= 80 \text{ MN/m}^3$ and representing a range in K of 60 to 120 MN/m^3 for rigid pavements, and by $\text{CBR}=10$ and representing a range in CBR of 8 to 13 for flexible pavements.	B
<u>Low strength</u> : characterized by $K=40 \text{ MN/m}^3$ and representing a range in K of 25 to 60 MN/m^3 for rigid pavements, and by $\text{CBR}=6$ and representing a range in CBR of 4 to 8 for flexible pavements.	C
<u>Ultra low strength</u> : characterized by $K= 20 \text{ MN/m}^3$ and representing all K values below 25 MN/m^3 for rigid pavements, and by $\text{CBR}=3$ and representing all CBR values below 4 for flexible pavements.	D
Maximum allowable tire pressure category:	
<u>High</u> : no pressure limit	W
<u>Medium</u> : pressure limited to 1.50 MPa	X
<u>Low</u> : pressure limited to 1.00 MPa	Y
<u>Very low</u> : pressure limited to 0.50 MPa	Z
Evaluation method:	
<u>Technical evaluation</u> : representing a specific study of the pavement characteristics and application of pavement behaviour technology.	T
<u>Using aircraft experience</u> : representing a knowledge of the specific type and mass of aircraft satisfactorily being supported under regular use.	U
<i>Note.— The following examples illustrate how pavement strength data are reported under the ACN-PCN method.</i>	
<i>Example 1.</i> — If the bearing strength of a rigid pavement, resting on a medium strength subgrade, has been assessed by technical evaluation to be PCN 80 and there is no tire pressure limitation, then the reported information would be:	
PCN 80/ R / B / W / T	
<i>Example 2.</i> — If the bearing strength of a composite pavement, behaving like a flexible pavement and resting on a high strength subgrade, has been assessed by using aircraft experience to be PCN 50 and the maximum tire pressure allowable is 1.00 MPa, then the reported information would be:	
PCN 50/ F/A/Y/U <i>Note.— Composite construction.</i>	
<i>Example 3.</i> — If the bearing strength of a flexible pavement, resting on a medium strength subgrade, has been assessed by technical evaluation to be PCN 40 and the maximum allowable tire pressure is 0.80 MPa, then the reported information would be:	
PCN 40 / F / B / 0.80 MPa / T	
<i>Example 4.</i> — If a pavement is subject to a B747-400 all-up mass limitation of 390000 kg, then the reported information would include the following note.	
<i>Note.— The reported PCN is subject to a B747-400 all-up mass limitation of 390000 kg.</i>	

2.4.2.2 Standard.— For the purposes of determining the ACN, the behaviour of a pavement shall be classified as equivalent to a rigid or flexible construction.

2.4.2.3 Standard.— Information on pavement type for ACN-PCN determination, subgrade strength category, maximum allowable tire pressure category and evaluation method shall be reported using the codes specified in Table 2-1.

2.4.2.4 Recommendation.— Procedures should be established to regulate the use of a pavement by an aircraft with an ACN higher than the PCN reported for that pavement in accordance with 2.4.2.2 and 2.4.2.3.

- d) standing - water on a runway, a taxiway or an apron;
- e) snow banks or drifts adjacent to a runway, a taxiway or an apron;
- f) anti-icing or de-icing liquid chemicals on a runway or a taxiway;
- g) other temporary hazards, including parked aircraft;
- h) failure or irregular operation of part or all of the aerodrome visual aids; and
- i) failure of the normal or secondary power supply.

2.5 CONDITION OF THE MOVEMENT AREA AND RELATED FACILITIES

2.5.1 GENERAL

2.5.1.1 Standard.— Information on the condition of the movement area and the operational status of related facilities shall be provided to the appropriate aeronautical information service units, and similar information of operational significance to the air traffic services units, to enable those units to provide the necessary information to arriving and departing aircraft. The information shall be kept up to date and changes in conditions reported without delay.

2.5.1.2 Standard.— The condition of the movement area and the operational status of related facilities shall be monitored and reports on matters of operational significance or affecting aircraft performance given, particularly in respect of the following:

- a) construction or maintenance work;
- b) rough or broken surfaces on a runway, a taxiway or an apron;
- c) snow, slush or ice on a runway, a taxiway or an apron;

2.5.1.3 Recommendation.— To facilitate compliance with 2.5.1.1 and 2.5.1.2 inspections of the movement area should be carried out each day at least once where the code number is 1 or 2 and at least twice where the code number is 3 or 4.

Note.— *Guidance on carrying out daily inspections of the movement area is given in;*

- a) *the Airport Safety Programs Manual, TP 11465;*
- b) *the ICAO Airport Services Manual, Part 8 ; and*
- c) *the ICAO Manual of Surface Movement Guidance and Control Systems (SMGCS).*

2.5.2 RUNWAY SURFACE CONDITION REPORTING

Water on a runway

2.5.2.1 Standard.— Information that a runway or portion thereof may be slippery when wet shall be made available.

2.5.2.2 Recommendation.— A runway or portion thereof should be determined as being slippery when wet when the measurements specified in 9.4.2 show that the runway surface friction characteristics as measured by a continuous friction measuring device are below the specified minimum friction level.

2.5.2.3 Recommendation.— When it is suspected that a runway may become slippery under unusual conditions, then additional measurements should be made when such conditions occur, and information on the runway surface friction characteristics made available when these additional measurements show that the runway or a portion thereof has become slippery.

Snow, slush or ice on a runway

Note 1.—The intent of these specifications is to satisfy the RSC/JBI requirements contained in the NOTAM Procedures Manual, TP 973.

Note 2.— Runway surface condition sensors may be used to detect and continuously display current or predicted information on surface conditions such as the presence of moisture, or imminent formation of ice on pavements.

2.5.2.4 Recommendation.— Whenever a runway is affected by snow, slush or ice, and it has not been possible to clear the precipitant fully, the condition of the runway should be assessed, and the friction coefficient measured.

2.5.2.5 Recommendation.— Whenever dry snow, wet snow or slush is present on a runway, an assessment of the mean depth over each third

of the runway should be made to an accuracy of approximately 2 cm for dry snow, 1 cm for wet snow and 0.3 cm for slush.

2.5.3 RESCUE AND FIRE FIGHTING

2.5.3.1 Standard.— Information concerning the level of protection provided at an aerodrome for aircraft rescue and fire fighting purposes shall be made available.

2.5.3.2 Recommendation.— The level of protection normally available at an aerodrome should be expressed in terms of the category of the rescue and fire fighting services in accordance with Table 2-2 and in accordance with the types and amounts of extinguishing agents normally available at the aerodrome.

2.5.3.3 Standard.— Significant changes in the level of protection normally available at an aerodrome for rescue and fire fighting shall be notified to the appropriate air traffic services units and aeronautical information units to enable those units to provide the necessary information to arriving and departing aircraft. When such a change has been corrected, the above units shall be advised accordingly.

Table 2-2. Aerodrome category for rescue and fire fighting

Aerodrome category	Aeroplane over all length	Maximum fuselage width
(1)	(2)	(3)
1	0 up to but not including 9 m	2 m
2	9 m up to but not including 12 m	2 m
3	12m up to but not including 18 m	3 m
4	18 m up to but not including 24 m	4 m
5	24 m up to but not including 28 m	4 m
6	28 m up to but not including 39 m	5 m
7	39 m up to but not including 49 m	5 m
8	49 m up to but not including 61 m	7 m
9	61 m up to but not including 76 m	7 m

Note.— To categorize the aeroplanes using the aerodrome, first evaluate their over-all length and, second, their fuselage width. If, after selecting the category appropriate to an aeroplanes over-all length, That aeroplane's fuselage width is greater than the maximum width in column 3 for that category, then the category for that aeroplane is actually on category higher.

Note.— A significant change in the level of protection is considered to be a change in the category of the rescue and fire fighting service from the category normally available at the aerodrome, resulting from a change in availability of extinguishing agents, equipment to deliver the agents or personnel to operate the equipment, etc.

2.5.3.4 Recommendation.— A significant change should be expressed in terms of the new category of the rescue and fire fighting service available at the aerodrome.

CHAPTER 3. PHYSICAL CHARACTERISTICS

3.1 RUNWAYS

3.1.1 GENERAL

Number and Orientation of Runways

Introductory Note.— Many factors affect the determination, siting and number of runways.

One important factor is the usability factor, as determined by the wind distribution, which is specified hereunder. Another important factor is the alignment of the runway to facilitate the provision of approaches conforming to the approach surface specifications of Chapter 4. In Attachment A, Section 1, information is given concerning these and other factors.

*When a new instrument runway is being located, particular attention needs to be given to areas over which aeroplanes will be required to fly when following instrument approach and missed approach procedures, so as to ensure that obstacles in these areas or other factors will not restrict the operation of the aeroplanes for which the runway is intended. Guidance on the development of instrument approach procedures is given in the manual, *Criteria for the Development of Instrument Procedures, TP 308*.*

3.1.1.1 Recommendation.— The number and orientation of runways at an aerodrome should be such that the usability factor of the aerodrome is not less than 95 per cent for the aeroplanes that the aerodrome is intended to serve.

Choice of maximum permissible cross-wind components

3.1.1.2 Recommendation.— In the application of 3.1.1.1 it should be assumed that landing or take-off of aeroplanes is, in normal circumstances, precluded when the cross-wind component exceeds:

- 37 km/h (20 kts) in the case of aeroplanes whose reference field length is 1500 m or over, except that when poor runway braking

action owing to an insufficient longitudinal coefficient of friction is experienced with some frequency, a cross-wind component not exceeding 24 km/h (13 kt) should be assumed;

- 24 km/h (13 kts) in the case of aeroplanes whose reference field length is 1200 m or up to but not including 1500 m; and
- 19 km/h (10 kts) in the case of aeroplanes whose reference field length is less than 1200 m.

Note.— In Attachment A, Section 1, guidance is given on factors affecting the calculation of the estimate of the usability factor and allowances which may have to be made to take account of the effect of unusual circumstances.

Data to be used

3.1.1.3 Recommendation.— The selection of data to be used for the calculation of the usability factor should be based on reliable wind distribution statistics that extend over as long a period as possible, preferably of not less than five years. The observations used should be made at least eight times daily and spaced at equal intervals of time.

Note.— These winds are mean winds. Reference to the need for some allowance for gusty conditions is made in Attachment A, Section 1.

Location of Threshold

3.1.1.4 Recommendation.— A threshold should normally be located at the extremity of a runway unless operational considerations justify the choice of another location.

3.1.1.5 Recommendation.— When it is necessary to displace a threshold, either permanently or temporarily, from its normal location, account should be taken of the various factors which may have a bearing on the location of the threshold. Where this displacement is due to

an unserviceable runway condition, a cleared and graded area of at least 60 m in length should be available between the unserviceable area and the displaced threshold. Additional distance should also be provided to meet the requirements of the runway end safety area as appropriate.

Actual Length of Runways

Primary runway

3.1.1.6 Recommendation.— Except as provided in 3.1.1.8, the actual runway length to be provided for a primary runway should be adequate to meet the operational requirements of the aeroplanes for which the runway is intended and should be not less than the longest length determined by applying the corrections for local conditions to the operations and performance characteristics of the relevant aeroplanes.

Note 1.— *This specification does not necessarily mean providing for operations by the critical aeroplane at its maximum mass.*

Note 2.— *Both take-off and landing requirements need to be considered when determining the length of runway to be provided and the need for operations to be conducted in both directions of the runway.*

Note 3.— *Local conditions that may need to be considered include elevation, temperature, runway slope, humidity and the runway surface characteristics.*

Note 4.— *When performance data on aeroplanes for which the runway is intended are not known, guidance on the determination of the actual length of a primary runway by application of general correction factors is given in the ICAO Aerodrome Design Manual, Part 1.*

Secondary runway

3.1.1.7 Recommendation.— The length of a secondary runway should be determined similarly to primary runways except that it needs only to be adequate for those aeroplanes which require to use that secondary runway in addition to the other runway or runways in order to obtain a usability factor of at least 95 per cent.

Runways with stopways or clearways

3.1.1.8 Recommendation.— Where a runway is associated with a stopway or clearway, an actual runway length less than that resulting from application of 3.1.1.6 or 3.1.1.7, as appropriate, may be considered satisfactory, but in such a case any combination of runway, stopway and clearway provided should permit compliance with the operational requirements for take-off and landing of the aeroplanes the runway is intended to serve.

Note.— *Guidance on use of stopways and clearways is given in Attachment A, Section 2.*

Width of Runways

3.1.1.9 Recommendation.— The width of a runway should be not less than the appropriate dimension specified in the following tabulation:

<u>Code number</u>	<u>Code letter</u>				
	A	B	C	D	E
1	15 m	18 m	23 m	—	—
2	23 m	23 m	30 m	—	—
3	30 m	30 m	30 m	45 m	—
4	—	—	45 m	45 m	60 m

3.1.1.10 Recommendation.— The width of a precision approach runway should be not less than 30 m where the code number is 1 or 2.

Note.— *The combinations of code numbers and letters for which widths are specified have been developed for typical aeroplane characteristics.*

Separation of Parallel Runways

3.1.1.11 Standard.— Where parallel runways are provided for simultaneous use under visual meteorological conditions only, the minimum distance between their centre lines shall be:

- 210 m where the higher code number is 3 or 4;
- 150 m where the higher code number is 2; and
- 120 m where the higher code number 1.

3.1.1.12 Standard.— Where parallel runways are provided for simultaneous operations under instrument meteorological conditions, the minimum separation distance between their centre lines shall be:

- 1300 m for independent parallel approaches;
- 760 m for dependent parallel approaches;
- 760 m for independent parallel departures;
- 760 m for segregated parallel operations;

except that for segregated parallel operations the specified separation distance:

- a) may be decreased by 30 m for each 150 m that the arrival runway is staggered toward the arriving aircraft, to a minimum of 300 m; and
- b) shall be increased by 30 m for each 150 m that the arrival runway is staggered away from the arriving aircraft.

Note.— *Guidance on planning and conducting simultaneous operations on parallel or near-parallel instrument runways is contained in ICAO Circular 207 – Simultaneous Operations on Parallel or Near-Parallel Instrument Runways (SOIR).*

3.1.2 SLOPES ON RUNWAYS

Longitudinal slopes

3.1.2.1 Standard.— The slope computed by dividing the difference between the maximum and minimum elevation along the runway centre line by the runway length shall not exceed:

- 1.5 per cent where the code number is 3 or 4; and
- 2.5 per cent where the code number is 1 or 2.

3.1.2.2 Recommendation.— The slope computed in para 3.1.2.1 should be limited to 1.0 per cent where the code number is 3 or 4 and 2.0 per cent where the code number is 1 or 2.

3.1.2.3 Standard.— Along no portion of a runway shall the longitudinal slope exceed:

- 1.25 per cent where the code number is 4, except that for the first and last quarter of the length of the runway the longitudinal slope should not exceed 0.8 per cent;
- 1.5 per cent where the code number is 3, except that for the first and last quarter of the length of a precision approach runway category II or III the longitudinal slope should not exceed 0.8 per cent; and
- 2 per cent where the code number is 1 or 2.

Longitudinal slope changes

3.1.2.4 Recommendation.— Where slope changes cannot be avoided, a slope change between two consecutive slopes should not exceed:

- 1.5 per cent where the code number is 3 or 4; and
- 2 per cent where the code number is 1 or 2.

Note.— *Guidance on slope changes before a runway is given in Attachment A, Section 3.*

3.1.2.5 Recommendation.— The transition from one slope to another should be accomplished by a curved surface with a rate of change not exceeding:

- 0.1 per cent per 30 m (minimum radius of curvature of 30000 m) where the code number is 4;
- 0.2 per cent per 30 m (minimum radius of curvature of 15000 m) where the code number is 3; and
- 0.4 per cent per 30 m (minimum radius of curvature of 7500 m) where the code number is 1 or 2.

Sight Distance

3.1.2.6 Recommendation.— Where slope changes cannot be avoided, they should be such that there will be an unobstructed line of sight from:

- any point 3 m above a runway to all other points 3 m above the runway within a distance of at least half the length of the runway where the code letter is C, D or E;
- any point 2 m above a runway to all other points 2 m above the runway within a distance of at least half the length of the runway where the code letter is B; and
- any point 1.5 m above a runway to all other points 1.5 m above the runway within a distance of at least half the length of the runway where the code letter is A.

Distance between slope changes

3.1.2.7 Recommendation.— Undulations or appreciable changes in slopes located close together along a runway should be avoided. The distance between the points of intersection of two successive curves should not be less than:

- a) the sum of the absolute numerical values of the corresponding slope changes multiplied by the appropriate value as follows:
 - 30000 m where the code number is 4;
 - 15000 m where the code number is 3; and
 - 5000 m where the code number is 1 or 2;

or

- b) 45 m;

whichever is greater.

Note.— *Guidance on implementing this specification is given in Attachment A, Section 3.*

Transverse Slopes

3.1.2.8 Recommendation.— To promote the most rapid drainage of water, the runway surface should, if practicable, be cambered except where a single crossfall from high to low in the direction of the wind most frequently associated with rain would ensure rapid drainage. The

transverse slope should not exceed:

- 1.5 per cent where the code letter is C, D or E; and
- 2 per cent where the code letter is A or B;

nor be less than 1 per cent except at runway or taxiway intersections where flatter slopes may be necessary.

3.1.2.9 Recommendation.— For a cambered runway surface, the transverse slope on each side of the centre line should be symmetrical.

Note.— *On wet runways with cross-wind conditions the problem of aquaplaning from poor drainage is apt to be accentuated.*

3.1.2.10 Recommendation.— The transverse slope should be substantially the same throughout the length of a runway except at an intersection with another runway or a taxiway where an even transition should be provided taking account of the need for adequate drainage.

Note.— *Guidance on transverse slope is given in the ICAO Aerodrome Design Manual, Part 3.*

3.1.3 STRENGTH OF RUNWAYS

3.1.3.1 Recommendation.— A runway should be capable of withstanding the traffic of aeroplanes the runway is intended to serve.

3.1.4 SURFACE OF RUNWAYS

3.1.4.1 Standard.— The surface of a runway shall be constructed without irregularities that would result in loss in friction characteristics or otherwise adversely affect the take-off or landing of an aeroplane.

Note 1.— *Surface irregularities may adversely affect the take-off or landing of an aeroplane by causing excessive bouncing, pitching, vibration, or other difficulties in the control of an aeroplane.*

Note 2.— *Guidance on design tolerances and other information is given in Attachment A, Section*

4. Additional guidance is included in the ICAO Aerodrome Design Manual, Part 3.

3.1.4.2 Standard.— The surface of a paved runway shall be so constructed as to provide good friction characteristics when the runway is wet.

3.1.4.3 Recommendation.— Measurements of the friction characteristics of a new or resurfaced runway should be made with a continuous friction measuring device using self-wetting features in order to assure that the design objectives with respect to its friction characteristics have been achieved.

Note.— Guidance on friction characteristics of new runway surfaces is given in the ICAO Airport Services Manual, Part 2.

3.1.4.4 Recommendation.— The average surface texture depth of a new surface should be not less than 1.0 mm.

Note 1.— This normally requires some form of special surface treatment.

Note 2.— Guidance on methods used to measure surface texture is given in the ICAO Airport Services Manual, Part 2.

3.1.4.5 Recommendation.— When the surface is grooved or scored, the grooves or scorings should be either perpendicular to the runway centre line or parallel to non-perpendicular transverse joints, where applicable.

Note.— Guidance on methods for improving the runway surface texture is given in the ICAO Aerodrome Design Manual, Part 3.

3.1.5 RUNWAY SHOULDERS

General

Note.— Guidance on characteristics and treatment of runway shoulders is given in Attachment A, Section 5, and in the ICAO Aerodrome Design Manual, Part 2.

3.1.5.1 Recommendation.— Runway shoulders should be provided for a runway where the code letter is D and the runway is intended to serve large turbo-jet aeroplanes.

Width of runway shoulders

3.1.5.2 Recommendation.— The runway shoulders should extend symmetrically on each side of the runway so that the over-all width of the runway and its shoulders is not less than 60 m.

Slopes on runway shoulders

3.1.5.3 Recommendation.— The surface of the shoulder that abuts the runway should be flush with the surface of the runway and its transverse slope should not exceed 2.5 per cent.

Strength of runway shoulders

3.1.5.4 Recommendation.— A runway shoulder should be prepared or constructed so as to be capable, in the event of an aeroplane running off the runway, of supporting the aeroplane without inducing structural damage to the aeroplane and of supporting ground vehicles which may operate on the shoulder.

3.1.6 RUNWAY STRIPS

General

3.1.6.1 Standard.— A runway and any associated stopways shall be included in a strip.

Length of runway strips

3.1.6.2 Standard.— A strip shall extend before the threshold and beyond the end of the runway or stopway for a distance of at least:

- 60 m where the code number is 2, 3 or 4;
- 60 m where the code number is 1 and the runway is an instrument one; and
- 30 m where the code number is 1 and the runway is a non-instrument one.

Width of runway strips

3.1.6.3 Standard.— A strip including a precision approach runway shall extend laterally to a distance of at least:

- 150 m where the code number is 3 or 4; and
- 75 m where the code number is 1 or 2;

on each side of the centre line of the runway and its extended centre line throughout the length of the strip.

3.1.6.4 Standard.— A strip including a non-precision approach runway shall extend laterally to a distance of at least:

- 150 m where the code number is 4;
- 75 m where the code number is 3; and
- 45 m when the code number is 1 or 2;

on each side of the centre line of the runway and its extended centre line throughout the length of the strip.

3.1.6.5 Standard.— A strip including a non-instrument runway shall extend on each side of the centre line of the runway and its extended centre line throughout the length of the strip, to a distance of at least:

- 75 m where the code number is 4;
- 45 m where the code number is 3; and
- 30 m where the code number is 1 or 2.

Objects on runway strips

Note.— See 8.6 for information regarding siting and construction of equipment and installations on runway strips.

3.1.6.6 Recommendation.— An object situated on a runway strip which may endanger aeroplanes should be regarded as an obstacle and should, as far as practicable, be removed.

3.1.6.7 Standard.— No fixed object, other than visual aids required for air navigation purposes and satisfying the relevant frangibility requirement in Chapter 5, shall be permitted on a runway strip:

- a) within 60 m of the runway centre line of a precision approach runway category I, II or III where the code number is 3 or 4; or
- b) within 45 m of the runway centre line of a precision approach runway category I where the code number is 1 or 2.

3.1.6.8 Standard.— No mobile object shall be permitted on the part of the runway strip specified in 3.1.6.7 during the use of the runway for landing or take-off except that equipment and radio equipped personnel associated with inflight inspections of navigation and landing aids are permitted on a runway strip within graded areas while flight inspections are being carried out.

Grading of runway strips

Note.— Full compliance with the graded area requirements may in many cases impose an undue burden and be economically unreasonable, particularly for aerodromes in remote and isolated areas of sparse population. In such cases, an aeronautical study will be conducted to determine if a lesser graded area can be permitted.

3.1.6.9 Standard.— That portion of a strip of a precision approach runway within a distance of at least:

- 90 m where the code number is 4;
- 75 m where the code number is 3;
- 45 m where the code number is 2; and
- 30 m where the code number is 1;

from the centre line of the runway and its extended centre line shall provide a graded area for aeroplanes which the runway is intended to serve in the event of an aeroplane running off the runway.

3.1.6.10 Standard.— That portion of a strip of a non-precision approach runway within a distance of at least:

- 75 m where the code number is 4;
- 45 m where the code number is 3; and
- 23 m where the code number is 1 or 2;

from the centre line of the runway and its extended centre line shall provide a graded area for aeroplanes which the runway is intended to serve in the event of an aeroplane running off the runway.

3.1.6.11 Standard.— That portion of a strip of a non-instrument runway within a distance of at least:

- 60 m where the code number is 4;
- 40 m where the code number is 3;
- 23 m where the code number is 2; and
- 19 m where the code number is 1;

from the centre line of the runway and its extended centre line shall provide a graded area for aeroplanes which the runway is intended to serve in the event of an aeroplane running off the runway.

3.1.6.12 Standard.— The surface of that portion of a strip that abuts a runway, shoulder or stopway shall be flush with the surface of the runway, shoulder or stopway.

3.1.6.13 Recommendation.— That portion of a strip to at least 30 m before a threshold should be prepared against blast erosion in order to protect a landing aeroplane from the danger of an exposed edge and should be capable of supporting snow removal and emergency vehicles.

Slopes on runway strips

Longitudinal slopes

3.1.6.14 Recommendation.— A longitudinal slope along that portion of a strip to be graded should not exceed:

- 1.5 per cent where the code number is 4;
- 1.75 per cent where the code number is 3; and
- 2 per cent where the code number is 1 or 2.

Longitudinal slope changes

3.1.6.15 Recommendation.— Slope changes on that portion of a strip to be graded should be as gradual as practicable and abrupt changes or sudden reversals of slopes avoided.

3.1.6.16 Recommendation.— Slope changes before the threshold of a precision approach runway should be avoided or kept to a minimum on that portion of the strip within a distance of at least 30 m on each side of the extended centre line of the runway. Where slope changes cannot be avoided on this portion, the rate of change between two consecutive slopes should not exceed 2 per cent per 30 m.

Transverse slopes

3.1.6.17 Recommendation.— Transverse slopes on that portion of a strip to be graded should be adequate to prevent the accumulation of water on the surface but should not exceed:

- 2.5 per cent where the code number is 3 or 4; and
- 3 per cent where the code number is 1 or 2;

except that to facilitate drainage the slope for the first 3 m outward from the runway, shoulder or stopway edge should be negative as measured in the direction away from the runway and may be as great as 5 per cent.

3.1.6.18 Recommendation.— The transverse slopes of any portion of a strip beyond that to be graded should not exceed an upward slope of 5 per cent as measured in the direction away from the runway.

Drainage ditches

3.1.6.19 Standard.— Drainage ditches, shall not be located within the graded portion of the strip. Where drainage ditches are located at the edge of the graded area, they shall be contoured in order to reduce structural damage in the event an aeroplane overruns the ditch.

3.1.6.20 Recommendation.— Earth displaced by contouring of ditch sides, particularly on the side nearest the runway, should not significantly alter the transverse slopes.

3.1.6.21 Recommendation.— Open ditches should have a side slope of 4 units of horizontal measure to 1 unit of vertical measure. Open ditches should be graded and sodded for erosion control and ease of maintenance.

Strength of runway strips

3.1.6.22 Recommendation.— That portion of the runway strip that is graded in accordance with para 3.1.6.9, 3.1.6.10 and 3.1.6.11 should be so prepared or constructed as to minimize hazards arising from differences in load bearing capacity to aeroplanes which the runway is intended to serve in the event of an aeroplane running off the runway.

3.1.7 RUNWAY END SAFETY AREAS**General**

3.1.7.1 Recommendation.— A runway end safety area should be provided at each end of a runway strip where the code number is 3 or 4.

Dimensions of runway end safety areas

3.1.7.2 Recommendation.— A runway end safety area should extend from the end of a runway strip for as great a distance as practicable, but at least 90 m.

3.1.7.3 Recommendation.— The width of a runway end safety area should be at least twice that of the associated runway.

Objects on runway end safety areas

Note.— See 8.6 for information regarding siting and construction of equipment and installations on runway end safety areas.

3.1.7.4 Recommendation.— An object situated on a runway end safety area which may endanger aeroplanes should be regarded as an obstacle and should, as far as practicable, be removed.

Clearing and grading of runway end safety areas

3.1.7.5 Recommendation.— A runway end safety area should provide a cleared and graded area for aeroplanes which the runway is intended to serve in the event of an aeroplane undershooting or overrunning the runway.

Note.— The surface of the ground in the runway end safety area does not need to be prepared to the same quality as the runway strip.

See, however, 3.1.7.9

Slopes on runway end safety areasGeneral

3.1.7.6 Recommendation.— The slopes of a runway end safety area should be such that no part of the runway end safety area penetrates the approach or take-off climb surface.

Longitudinal slopes

3.1.7.7 Recommendation.— The longitudinal slopes of a runway end safety area should not exceed a downward slope of 5 per cent. Longitudinal slope changes should be as gradual as practicable and abrupt changes or sudden reversals of slopes avoided.

Transverse slopes

3.1.7.8 Recommendation.— The transverse slopes of a runway end safety area should not exceed an upward or downward slope of 5 per cent. Transitions between differing slopes should be as gradual as practicable.

Strength of runway end safety areas

3.1.7.9 Recommendation.— A runway end safety area should be so prepared or constructed as to reduce the risk of damage to an aeroplane undershooting or overrunning the runway and facilitate the movement of rescue and fire fighting vehicles.

3.2 CLEARWAYS

Note.— The inclusion of detailed specifications for clearways in this section is not intended to imply that a clearway has to be provided. Attachment A, Section 2 provides information on the use of clearways.

3.2.1 LOCATION OF CLEARWAYS

3.2.1.1 Recommendation.— The origin of a clearway should be at the end of the take-off run available.

3.2.2 LENGTH OF CLEARWAYS

3.2.2.1 Standard.— The length of a clearway shall not exceed:

- a) 300 m;
- b) the distance to the first object other than approach lights or other light weight frangibly mounted objects such as radio signal monitors that project above the slope of the clearway; or
- c) the distance to the point where the ground projects above the slope of the clearway.

Note.— A clearway may extend outside the aerodrome boundary only if the aerodrome operator has established control over the additional land to ensure that it will be kept clear of obstacles.

3.2.3 WIDTH OF CLEARWAYS

3.2.3.1 Standard.— A clearway shall extend laterally to a distance of at least 75 m on each side of the extended centre line of the runway or the width of the strip whichever is less.

3.2.4 SLOPES ON CLEARWAYS

3.2.4.1 Standard.— The ground in a clearway shall not project above a plane having an upward slope of 1.25 per cent, the lower limit of this plane being a horizontal line which:

- a) is perpendicular to the vertical plane containing the runway centre line; and
- b) passes through a point located on the runway centre line at the end of the take-off run available.

Note.— Because of transverse or longitudinal slopes on a runway, shoulder or strip, in certain cases the lower limit of the clearway plane specified above may be below the corresponding elevation of the runway, shoulder or strip. It is not intended that these surfaces be graded to conform with the lower limit of the clearway plane nor is it intended that terrain or objects which are above the clearway plane beyond the end of the strip but below the level of the strip be removed unless it is considered they may endanger aeroplanes.

3.2.4.2 Recommendation.— Abrupt upward changes in slope should be avoided when the slope on the ground in a clearway is relatively small or when the mean slope is upward. In such situations, in that portion of the clearway within a distance of 22.5 m on each side of the extended centre line, the slopes, slope changes and the transition from runway to clearway should generally conform with those of the runway with which the clearway is associated except that isolated depressions such as ditches running across the clearway may be permitted.

3.2.5 OBJECTS ON CLEARWAYS

Note.— See 8.6 for information regarding siting and construction of equipment and installations on clearways.

3.2.5.1 Standard.— The take-off distance available (TODA) shall be recalculated when an established clearway is infringed by a new object other than one specified in para 3.2.2.1(b).

3.2.5.2 Recommendation.— An object situated on a clearway which may endanger aeroplanes in the air should be regarded as an obstacle and should be removed.

without inducing structural damage to the aircraft.

Note.— Attachment A, Section 2 presents guidance relative to the support capability of a stopway.

3.3 STOPWAYS

Note.— The inclusion of detailed specifications for stopways in this section is not intended to imply that a stopway has to be provided. Attachment A, Section 2 provides information on the use of stopways.

3.3.1 WIDTH OF STOPWAYS

3.3.1.1 Standard.— A stopway shall have the same width as the runway with which it is associated.

3.3.2 SLOPES ON STOPWAYS

3.3.2.1 Standard.— Slopes and changes in slope on a stopway, and the transition from a runway to a stopway, shall comply with the specifications of 3.1.2.1 to 3.1.2.8 for the runway with which the stopway is associated except that:

- a) the limitation in 3.1.2.3 of a 0.8 per cent slope for the first and last quarter of the length of a runway need not be applied to the stopway; and
- b) at the junction of the stopway and runway and along the stopway the maximum rate of slope change may be 0.3 per cent 30 m (minimum radius of curvature of 10 000 m) for a runway where the code number is 3 or 4.

3.3.3 STRENGTH OF STOPWAYS

3.3.3.1 Standard.— A stopway shall be prepared or constructed so as to be capable, in the event of an abandoned take-off, of supporting the aircraft which the stopway is intended to serve

3.3.4 SURFACE OF STOPWAYS

3.3.4.1 Recommendation.— The surface of a paved stopway should be so constructed as to provide a good coefficient of friction when the stopway is wet.

3.3.4.2 Recommendation.— The friction characteristics of an unpaved stopway should not be substantially less than that of the runway with which the stopway is associated.

3.3.5 OBJECTS ON STOPWAYS

3.3.5.1 Standard.— Equipment or installations shall not be located on a stopway if it would endanger an aircraft unless its function requires it to be there for air navigation purposes.

3.3.5.2 Standard.— Equipment or installations located on a stopway shall meet the requirements of para 3.2.5.1.

3.4 TAXIWAYS

Note.— Unless otherwise indicated the requirements in this section are applicable to all types of taxiways.

3.4.1 GENERAL

3.4.1.1 Recommendation.— Taxiways should be provided to permit the safe and expeditious surface movement of aircraft.

Note.— Guidance on layout of taxiways is given in the ICAO Aerodrome Design Manual, Part 2.

3.4.1.2 Recommendation.— Sufficient entrance and exit taxiways for a runway should be provided to expedite the movement of aeroplanes to and from the runway and provision of rapid exit taxiways considered when traffic volumes are high. To reduce the risk of runway incursions, the number of taxiway entrances having direct access to a runway should be kept to the minimum required for efficient runway use.

Note.— Where the end of a runway is not served by a taxiway, it may be necessary to provide additional pavement at the end of the runway for the turning of aeroplanes. Such areas may also be useful along the runway to reduce taxiing time and distance for some aeroplanes.

3.4.1.3 Recommendation.— The design of a taxiway should be such that, when the cockpit of the aeroplane for which the taxiway is intended remains over the taxiway centre line markings, the clearance distance between the outer main wheel of the aeroplane and the edge of the taxiway should be not less than that given by the following tabulation:

<u>Code letter</u>	<u>Clearance</u>
A	1.5 m
B	2.25 m
C	3 m if the taxiway is intended to be used by aeroplanes with a wheel base less than 18 m; or

4.5 m if the taxiway is intended to be used by aeroplanes with a wheel base equal to or greater than 18 m.

D 4.5 m

E 4.5 m

Note.— Wheel base means the distance from the nose gear to the geometric centre of the main gear.

Private taxiways

3.4.1.4 Recommendation.— Taxiways which are privately owned and are used exclusively to serve private interests should connect to an apron or taxiway which is part of the airport taxiway network. They should not connect directly to a runway.

Width of taxiways

3.4.1.5 Recommendation.— A straight portion of a taxiway should have a width of not less than that given by the following tabulation:

<u>Code letter</u>	<u>Taxiway width</u>
A	7.5 m
B	10.5 m
C	15 m if the taxiway is intended to be used by aeroplanes with a wheel base less than 18 m; 18 m if the taxiway is intended to be used by aeroplanes with a wheel base equal to or greater than 18 m.
D	18 m if the taxiway is intended to be used by aeroplanes with an outer main gear wheel span of less than 9 m; 23 m if the taxiway is intended to be used by aeroplanes with an outer main gear wheel span equal to or greater than 9 m.
E	23 m

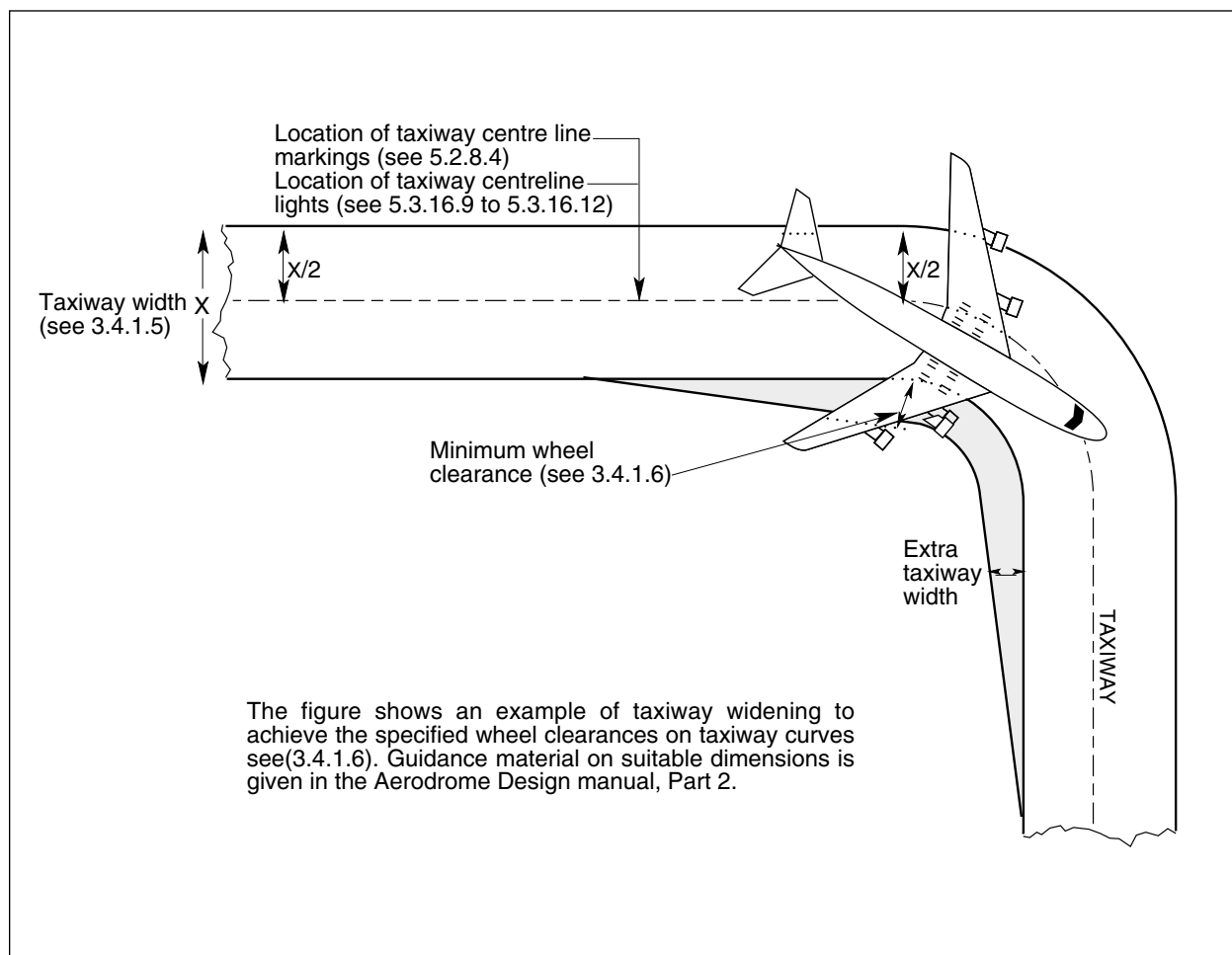

Figure 3-1. Taxiway Curve

Taxiway curves

3.4.1.6 Recommendation.— Changes in direction of taxiways should be as few and small as possible. The radii of the curves should be compatible with the manoeuvring capability and normal taxiing speeds of the aeroplanes for which the taxiway is intended. The design of the curve should be such that, when the cockpit of the aeroplane remains over the taxiway centre line markings, the clearance distance between the outer main wheels of the aeroplane and the edge of the taxiway should not be less than those specified in 3.4.1.3.

Note 1.— An example of widening taxiways to achieve the wheel clearance specified is illustrated in Figure 3–1. Guidance on the values of suitable dimensions is given in the ICAO Aerodrome Design Manual, Part 2.

Note 2.— The location of taxiway centre line markings and lights is specified in 5.2.8.4 and 5.3.16.9 to 5.3.16.12.

Note 3.— Compound curves may reduce or eliminate the need for extra taxiway width.

Junctions and intersections

3.4.1.7 Recommendation.— To facilitate the movement of aeroplanes, fillets should be provided at junctions and intersections of taxiways with runways, aprons and other taxiways. The design of the fillets should ensure that the minimum wheel clearances specified in 3.4.1.3 are maintained when aeroplanes are manoeuvring through the junctions or intersections.

Note.— Guidance on the design of fillets is given in the ICAO Aerodrome Design Manual, Part 2.

Taxiway minimum separation distances

3.4.1.8 Recommendation.— The separation distance between the centre line of a taxiway and the centre line of a runway, the centre line of a parallel taxiway or an object should not be less than the appropriate dimension specified in Table 3–1, except that it may be permissible to operate with lower separation distances at an existing aerodrome if an aeronautical study indicates that such lower separation distances would not adversely affect the safety or significantly affect the regularity of operations of aeroplanes.

Note 1.— Guidance on factors which may be considered in the aeronautical study is given in TP 7775, *Procedures for the Certification of Aerodrome as Airports, Chapter 5.*

Note 2.— ILS installations may also influence the location of taxiways due to interferences to ILS signals by a taxiing or stopped aircraft. Information on critical and sensitive areas surrounding ILS installation is contained in TP 1247, *Land Use in the Vicinity of Airports, Part 2*

Note 3.— The separation distances of Table 3-1, column 4 do not necessarily provide the capability of making a normal turn from one taxiway to another parallel taxiway. Guidance for this condition is given in the ICAO Aerodrome Design Manual, Part 2.

3.4.2 SLOPES ON TAXIWAYS

Longitudinal slopes

3.4.2.1 Recommendation.— The longitudinal slope of a taxiway should not exceed:

- 1.5 per cent where the code letter is C, D or E; and
- 3 per cent where the code letter is A or B.

Longitudinal slope changes

3.4.2.2 Recommendation.— Where slope changes on a taxiway cannot be avoided, the transition from one slope to another slope should be accomplished by a curved surface with a rate of change not exceeding:

- 1 per cent per 30 m (minimum radius of curvature of 3000 m) where the code letter is C, D or E; and
- 1 per cent per 25 m (minimum radius of curvature of 2500 m) where the code letter is A or B.

Sight distance

3.4.2.3 Recommendation.— Where a change in slope on a taxiway cannot be avoided,

Table 3-1. Taxiway Minimum Separation Distances

Code Letter	Distance between taxiway centre line and runway centre line (metres)												Taxiway centre line to taxiway centre line (metres)	Taxiway centre line to object (metres)		
	Precision approach runway				Non-precision approach runway				Non-instrument runway							
	(1)				(2)				(3)						(4)	(5)
	Code number				Code number				Code number							
	1	2	3	4	1	2	3	4	1	2	3	4				
A	82.5	82.5	----	----	53.0	53.0	----	----	37.5	37.5	----	----	23.75	16.25		
B	87.0	87.0	162.0	----	57.8	57.8	87.0	----	42.0	42.0	57.0	----	33.5	21.5		
C	----	----	168.0	----	----	----	92.0	----	----	48.0	63.0	----	44.0	26.0		
D	----	----	176.0	176.0	----	----	101.0	176.0	----	----	71.0	101.0	66.5	40.5		
E	----	----	----	182.5	----	----	----	182.5	----	----	----	107.5	80.0	47.5		

the change should be such that, from any point:

- 3 m above the taxiway, it will be possible to see the whole surface of the taxiway for a distance of at least 300 m from that point, where the code letter is C, D or E;
- 2 m above the taxiway, it will be possible to see the whole surface of the taxiway for a distance of at least 200 m from that point, where the code letter is B; and
- 1.5 m above the taxiway, it will be possible to see the whole surface of the taxiway for a distance of at least 150 m from that point, where the code letter is A.

Transverse slopes

3.4.2.4 Recommendation.— The transverse slopes of a taxiway should be sufficient to prevent the accumulation of water on the surface of the taxiway but should not exceed:

- 1.5 per cent where the code letter is C, D or E; and
- 2 per cent where the code letter is A or B.

Note.— See 3.6.4 regarding transverse slopes on an aircraft stand taxiway.

3.4.3 STRENGTH OF TAXIWAYS

3.4.3.1 Recommendation.— The strength of a taxiway should be at least equal to that of the runway it serves, due consideration being given to the fact that a taxiway will be subjected to a greater density of traffic and, as a result of slow moving and stationary aeroplanes, to higher stresses than the runway it serves.

Note.— Guidance on the relation of the strength of taxiways to the strength of runways is given in the ICAO Aerodrome Design Manual, Part 3.

3.4.4 SURFACE OF TAXIWAYS

3.4.4.1 Standard.— The surface of a taxiway shall not have irregularities that may cause damage to aeroplane structures.

3.4.4.2 Recommendation.— The surface of a paved taxiway should be so constructed as to provide good friction characteristics when the taxiway is wet.

3.4.5 RAPID EXIT TAXIWAYS

Note.— The following specifications detail requirements particular to rapid exit taxiways. See Figure 3–2. General requirements for taxiways also apply to this type of taxiway. Guidance on the provision, location and design of rapid exit taxiways is included in the ICAO Aerodrome Design Manual, Part 2.

3.4.5.1 Recommendation.— A rapid exit taxiway should be designed with a radius of turn-off curve of at least:

- 550 m where the code number is 3 or 4; and
- 275 m where the code number is 1 or 2;

to enable exit speeds under wet conditions of:

- 93 km/h (50 kts) where the code number is 3 or 4; and
- 65 km/h (35 kts) where the code number is 1 or 2.

Note.— The locations of rapid exit taxiways along a runway are based on several criteria described in the ICAO Aerodrome Design Manual, Part 2, in addition to different speed criteria.

3.4.5.2 Recommendation.— The radius of the fillet on the inside of the curve at a rapid exit taxiway should be sufficient to provide a widened taxiway throat in order to facilitate early recognition of the entrance and turn-off onto the taxiway.

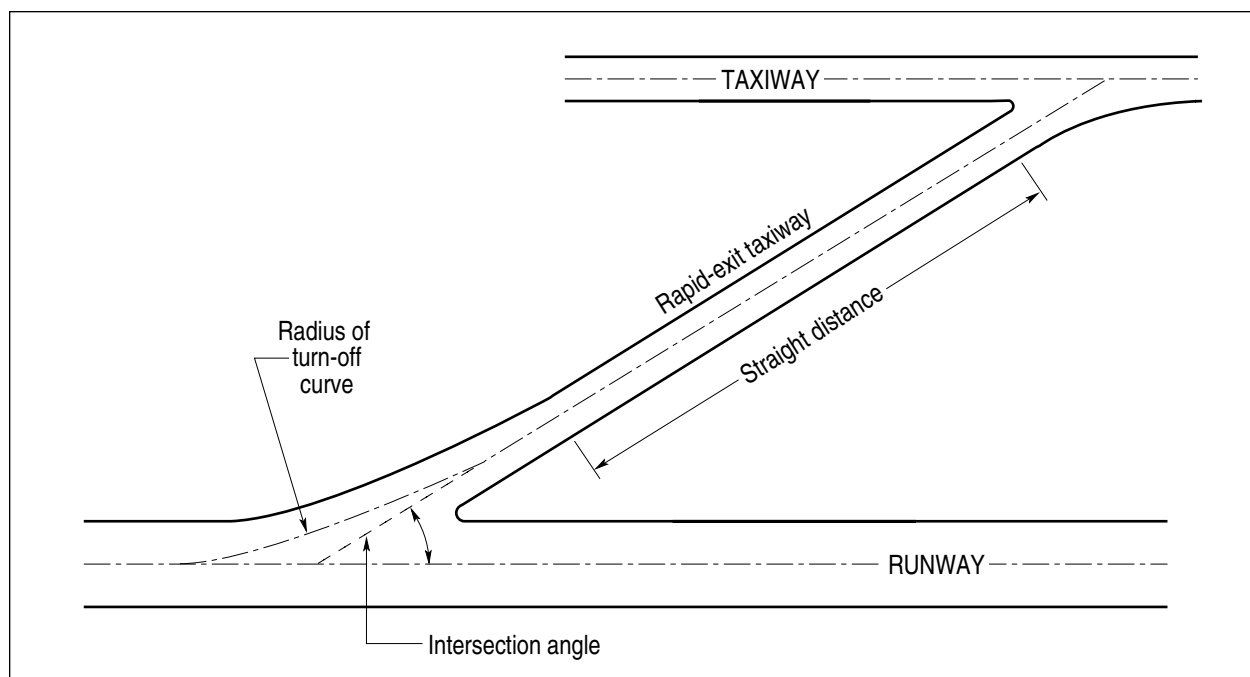

Figure 3-2. Rapid Exit Taxiways

3.4.5.3 Recommendation.— A rapid exit taxiway should include a straight distance after the turn-off curve sufficient for an exiting aircraft to come to a full stop clear of any intersecting taxiway.

3.4.5.4 Recommendation.— The intersection angle of a rapid exit taxiway with the runway should not be greater than 45° nor less than 25° and preferably should be 30° .

3.4.6 TAXIWAYS ON BRIDGES

3.4.6.1 Standard.— The width of that portion of a taxiway bridge capable of supporting aeroplanes, as measured perpendicularly to the taxiway centre line, shall not be less than the width of the graded area of the strip provided for that taxiway, unless a method of lateral restraint is provided which shall not be hazardous for aeroplanes for which the taxiway is intended.

Note 1.— When a width less than the width of the graded area of the strip is provided, consideration will have to be given to access by rescue and fire fighting vehicles.

Note 2.— If aeroplane engines overhang the bridge structure, protection of adjacent areas below the bridge from engine blast may be required.

3.4.6.2 Recommendation.— A bridge should be constructed on a straight section of the taxiway with a straight section on both ends of the bridge to facilitate the alignment of aeroplanes approaching the bridge.

3.4.7 TAXIWAY SHOULDERS

General

Note.— Guidance on characteristics of taxiway shoulders and on shoulder treatment is given in the ICAO Aerodrome Design Manual, Part 2.

3.4.7.1 Recommendation.— Straight portions of a taxiway where the code letter is C, D or E should be provided with shoulders which extend symmetrically on each side of the taxiway so that the over-all width of the taxiway and its shoulders on straight portions is not less than:

- 44 m where the code letter is E;
- 38 m where the code letter is D; and
- 25 m where the code letter is C.

3.4.7.2 Recommendation.— On taxiway curves and on junctions or intersections where increased pavement is provided, the shoulder

width should be not less than that on the adjacent straight portions of the taxiway.

3.4.7.3 Standard.— When a taxiway is intended to be used by turbine-engined aeroplanes, the surface of the taxiway shoulder shall be so prepared as to resist erosion and the ingestion of the surface material by aeroplane engines.

3.4.8 TAXIWAY STRIPS

Note.— *Guidance on characteristics of taxiway strips is given in the ICAO Aerodrome Design Manual, Part 2.*

General

3.4.8.1 Standard.— A taxiway shall be included in a strip.

Width of taxiway strips

3.4.8.2 Recommendation.— A taxiway strip should extend symmetrically on each side of the centre line of the taxiway throughout the length of the taxiway to at least the distance from the centre line given in Table 3–1, column 5.

Objects on taxiway strips

Note.— *See 8.6 for information regarding siting and construction of equipment and installations on taxiway strips.*

3.4.8.3 Recommendation.— The taxiway strip should provide an area clear of objects which may endanger taxiing aeroplanes.

Grading of taxiway strips

3.4.8.4 Recommendation.— The centre portion of a taxiway strip should provide a graded area to a distance from the centre line of the taxiway of at least:

- 11 m where the code letter is A;
- 12.5 m where the code letter is B or C;
- 19 m where the code letter is D; and
- 22 m where the code letter is E.

Slopes on taxiway strips

3.4.8.5 Recommendation.— The surface of the strip should be flush at the edge of the taxiway or shoulder, if provided, and the graded portion should not have an upward transverse slope exceeding:

- 2.5 per cent for strips of taxiways where the code letter is C, D or E; and
- 3 per cent for strips of taxiways where the code letter is A or B;

the upward slope being measured with reference to the transverse slope of the adjacent taxiway surface and not the horizontal. The downwards transverse slope should not exceed 5 per cent measured with reference to the horizontal.

3.4.8.6 Recommendation.— The transverse slopes on any portion of a taxiway strip beyond that to be graded should not exceed an upward slope of 5 per cent as measured in the direction away from the taxiway.

3.5 HOLDING BAYS, TAXI-HOLDING POSITIONS, AND ROAD-HOLDING POSITIONS

3.5.1 HOLDING BAYS

Application

3.5.1.1 Recommendation.— Holding bay(s) should be provided when the traffic volume is high.

Location

3.5.1.2 Standard.— The distance between the nearest edge of a holding bay and the centre line of a runway shall be not less than the appropriate dimension specified in Table 3–2, and in the case of a precision approach runway, such that a holding aircraft will not interfere with the operation of radio navigation aids.

3.5.2 TAXI-HOLDING POSITIONS

Application

3.5.2.1 Standard.— A taxi-holding position or positions shall be established:

- a) at an intersection of a taxiway with a runway;
- b) at an intersection of a runway with another runway when the former runway is part of a standard taxi-route; and
- c) at an intersection of a runway with a runway where the runway is used for simultaneous intersecting runway operations.

Location

3.5.2.2 Standard.— Except as specified in para 3.5.2.3, the distance between a taxi-holding position established at a taxiway/runway intersection and the centre line of a runway shall be not less than the appropriate dimension specified in Table 3-2, and in the case of a precision approach runway, such that a holding aircraft or vehicle will not interfere with the operation of radio navigation aids.

3.5.2.3 Recommendation.— Where a taxiway/runway intersection occurs at other than the runway threshold and aircraft hold for the purpose of crossing the runway on a frequent or recurring basis, the distance between the taxi-holding position and the centre line of the runway should be increased to be not less than the appropriate dimensions specified in Table 3-3.

3.5.2.4 Standard.— A taxi-holding position at a runway/runway intersection shall be located at a distance not less than 60 m from the nearest edge of the intersecting runway.

3.5.3 ROAD-HOLDING POSITIONS

Application

3.5.3.1 Standard.— A road-holding position shall be established at an intersection of a road with a runway.

Location

3.5.3.2 Standard.— The distance between a road-holding position and the centre line of a runway shall be not less than the

Table 3-2 Minimum distance from the runway centre line to a holding bay, taxi-holding position, or road-holding position

Type of Runway	CODE NUMBER			
	1	2	3	4
Non-instrument approach	30 m	40 m	75 m	75 m
Non precision approach	40 m	40 m	75 m	75 m
Precision approach Cat I	60 m (1)	60 m (1)	90 m (1)	90 m (1)
Precision approach Cat II and III	-----	-----	90 m (1)	90 m (1)
Take-off Runway	30 m	40 m	75 m	75 m

Note 1.—This distance shall not be closer than the ILS/MLS critical/sensitive area.

Note 2.— The distance of 90m where the code number is 4, is based on an aeroplane with a tail height of 20m, a distance from the nose to the highest part of the tail of 52.7m and a nose height of 10m holding at an angle of 45 degrees or more with respect to the runway centre line, being clear of the obstacle free zone and not accountable for the calculation of obstacle clearance for instrument approach procedures.

Note 3.— The distance of 60m where the code number 2 is based on an aeroplane with a tail height of 8m, a distance from the nose to the highest part of the tail of 24.6 and a nose height of 5.2m holding at an angle of 45 degrees or more with respect to the runway centre line, being clear of the obstacle free zone.

Table 3-3. Minimum distance from the runway centre line to a frequently used taxi-holding position or road-holding position not located at the runway threshold

Type of Runway	CODE NUMBER			
	1	2	3	4
Non-instrument approach	75 m	75 m	115 m	115 m
Non precision approach	75 m	75 m	115 m	115 m
Precision approach Cat I	90 m (1)	90 m (1)	115 m (1)	115 m(1)
Precision approach Cat II and III	-----	-----	115 m (1)	115 m(1)
Take-off Runway: A	30 m	40 m	105 m	105 m
B	75 m	75 m	115 m	115 m

A—For take-off runways only, taxi-holding positions or road-holding positions established beyond the runway departure end up to and including the mid-point of the runway.

B—For take-off runways only, taxi-holding positions or road holding positions established beyond the departure runway mid-point to the end of the runway.

Note 1.— This distance shall not be closer than the ILS/MLS critical/sensitive area.

appropriate dimension specified in Table 3–2, and in the case of a precision approach runway, such that a holding vehicle will not interfere with the operation of radio navigation aids.

3.5.3.3 Recommendation.— Where vehicles hold at other than a runway threshold on a frequent or recurring basis for the purpose of crossing runways, the distance between the road-holding position and the centre line of a runway should not be less than the appropriate dimensions specified in Table 3-3.

3.6 APRONS

3.6.1 GENERAL

3.6.1.1 Recommendation.— Aprons should be provided where necessary to permit the on–and–off–loading of passengers, cargo or mail as well as the servicing of aircraft without interfering with the aerodrome traffic.

3.6.2 SIZE OF APRONS

3.6.2.1 Recommendation.— The total apron area should be adequate to permit expeditious

handling of the aerodrome traffic at its maximum anticipated density.

3.6.3 STRENGTH OF APRONS

3.6.3.1 Standard.— Each part of an apron shall be capable of withstanding the traffic of the aircraft it is intended to serve, due consideration being given to the fact that some portions of the apron will be subjected to a higher density of traffic and, as a result of slow moving or stationary aircraft, to higher stresses than a runway.

3.6.4 SLOPES ON APRONS

3.6.4.1 Recommendation.— Slopes on an apron, including those on an aircraft stand taxilane, should be sufficient to prevent accumulation of water on the surface of the apron but should be kept as level as drainage requirements permit.

3.6.4.2 Recommendation.— On an aircraft stand the maximum slope should not exceed 1 per cent.

3.6.4.3 Recommendation.— Aprons should not slope toward any building. If such a slope is unavoidable, special measures should be taken to

reduce the fire hazard posed by spilled flammable liquids.

3.6.5 CLEARANCE DISTANCES ON APRONS AND AIRCRAFT STANDS

3.6.5.1 Recommendation.— An aircraft stand should provide the following minimum clearances between an aircraft using the stand and any adjacent building, aircraft on another stand and other objects:

<u>Code letter</u>	<u>Clearance</u>
A	3.0 m
B	3.0 m
C	4.5 m
D	7.5 m
E	7.5 m

When special circumstances so warrant, these clearances may be reduced at a nose-in aircraft stand, where the code letter is D or E:

- a) between the terminal, including any fixed passenger bridge, and the nose of an aircraft; and
- b) over any portion of the stand provided with azimuth guidance by a visual docking guidance system.

3.6.5.2 Recommendation.— The following minimum clearances should be provided between the apron edge and any adjacent building or other object:

<u>Code letter</u>	<u>Clearance</u>
A	7.5 m
B	7.5 m
C	15.0 m
D	15.0 m
E	15.0 m

Note.— On aprons, consideration also has to be given to the provision of service roads and to manoeuvring and storage area for ground equipment.

3.6.6 AIRCRAFT STAND TAXILANE MINIMUM SEPARATION DISTANCES

3.6.6.1 Recommendation.— The following minimum separation distances should be provided between the centre line of an aircraft stand taxilane and an object :

<u>Code letter</u>	<u>Clearance</u>
A	12.0 m
B	16.5 m
C	24.5 m
D	36.0 m
E	42.5 m

Note.— The separation distance between the centre line of an aircraft stand taxilane and an object may need to be increased when jet exhaust wake velocity might cause hazardous conditions for ground servicing.

3.6.7 ISOLATED AIRCRAFT PARKING POSITION

Application

3.6.7.1 Standard.— At an International Airport, an isolated aircraft parking position shall be designated or the aerodrome control tower shall be advised of an area or areas suitable for the parking of an aircraft which is known or believed to be the subject of unlawful interference, or which for other reasons needs isolation from normal aerodrome activities.

Location

3.6.7.2 Standard.— The isolated aircraft parking position shall be located at least 100 m from other parking positions, buildings, or public use areas.

3.6.7.3 Recommendation.— The isolated aircraft parking position should be located at the maximum distance practicable from other parking positions, buildings, or public areas, etc. Care should be taken to ensure that the position is not located over underground utilities such as gas and aviation fuel and, to the extent feasible, electrical or communication cables.

CHAPTER 4. OBSTACLE RESTRICTION AND REMOVAL

Introductory Note.— The objectives of the specifications in this chapter are;

- a) *to define the airspace around aerodromes to be maintained free from obstacles in order to minimize the dangers presented by obstacles to an aircraft, either during an entirely visual approach or during the visual segment of an instrument approach; and*
- b) *to prevent the aerodrome from becoming unusable by the growth of obstacles around the aerodrome.*

These objectives are achieved by establishing a series of obstacle limitation surfaces that define the limits to which objects may project into the airspace.

4.1 OBSTACLE LIMITATION SURFACES

Note 1.— Obstacle limitation surfaces normally extend beyond the boundary of the aerodrome. Such surfaces can be protected by the enactment of Registered Zoning Regulations in accordance with the Aeronautics Act. Enactment of such a regulation will prohibit the erection of any new structure which would violate any of the defined surfaces.

Note 2.— Objects which project into the obstacle limitation surfaces may in certain circumstances cause an increase in the obstacle clearance altitude/height for an instrument approach procedure or any associated visual circling procedure. Criteria for evaluating obstacles are contained in, Criteria for the Development of Instrument Procedures, TP 308. TP 308 also provides further information on the distinction between obstacle limitation surfaces and obstacle clearance surfaces.

Note 3.— The establishment of, and requirements for, an obstacle protection surface for visual approach slope indicator systems are specified in 5.3.6.23 to 5.3.6.27.

4.1.1 OUTER SURFACE

Characteristics

4.1.1.1 Standard.— The limits of an Outer Surface shall comprise a common plane established at a constant elevation above the assigned elevation of the aerodrome reference point and extending over a horizontal distance:

- of at least 4000 m where the code number is 1, 2 or 3;
- to be determined by an aeronautical study where the code number is 4, but never less than 4000 m;

measured from the designated aerodrome reference point or points and extending over an area not less than 180° sector along the runway centre line

4.1.1.2 Recommendation.— An outer surface should extend horizontally 360° about the aerodrome.

4.1.1.3 Standard.— An outer surface shall be established at 45 m above the assigned elevation of the aerodrome reference point except, when the common plane is less than 9 m above the ground, an imaginary surface shall be established 9 m above the surface of the ground. (see Figure 4-1)

Note.— The imaginary surface at 9 m is intended to allow for an isolated topographical obstruction.

4.1.2 TAKE-OFF/ APPROACH SURFACE

Characteristics

4.1.2.1 Standard.— The limits of the take-off/approach surface shall comprise:

- a) an inner edge of specified length perpendicular to and evenly divided on each

side of the extended centre line of the runway, beginning at the end of the runway strip;

- b) two sides originating at the ends of the inner edge, diverging uniformly at a specified rate in the direction of take-off, terminating at the outer edge; and
- c) an outer edge parallel to the inner edge at a specified length from the inner edge.

Note.— *The width of the take-off/approach surface at any point can be found by summing the products of the length (ie. distance from inner edge) and the divergence (either side) with the length of the inner edge.*

4.1.2.2 Standard.— Where a threshold has been displaced, the inner edge shall be located at the point of displacement. In this event the landing distance available will be reduced by an amount equal to the displacement and it will be necessary to recalculate the declared distance information for the aerodrome.

Note.— *See 2.3.2 on calculation of declared distances.*

4.1.2.3 Standard.— The elevation of the inner edge shall be equal to the elevation of the threshold.

Note.— *Because of transverse slopes on a strip, in certain cases portions of the inner edge of the take-off/approach surface may be below the corresponding elevation of the strip. It is not intended that the strip be graded to conform to the inner edge.*

4.1.2.4 Recommendation.— Where practicable, the inner edge should be located at a position that will allow the take-off/approach surface to clear the airport boundary by at least 9 m vertically.

4.1.2.5 Standard.— The slope(s) of the take-off/approach surface shall be measured in the vertical plane containing the centre line of the runway, and shall be of a constant gradient.

4.1.2.6 Standard.— The widths and lengths of the take-off/approach surfaces shall be measured in the horizontal plane.

4.1.3 TRANSITIONAL SURFACE

Characteristics

4.1.3.1 Standard.— The limits of the transitional surface shall comprise:

- (a) a lower edge beginning at the intersection of the side of the approach surface with the outer surface and extending down the side of the approach surface to the inner edge of the approach surface and from there along the edge of the strip; and
- (b) an upper edge located in the plane of the outer surface or 45 m above airport assigned elevation if no outer surface has been established.

Note.— *A transitional surface is a combination of three planar surfaces. The first is a trapezoidal surface that rises from the edge of the runway strip at the specified slope till reaches the upper edge. Joining this surface on either end are triangular surfaces that are completed by the lower edge along the take-off/approach surface and the upper edge (see Figure 4-1).*

4.1.3.2 Standard.— The elevation of a point on the lower edge shall be:

- (a) along the side of the take-off/approach surface prescribed in this chapter; equal to the elevation of the take-off/approach surface at that point; and,
- (b) along the runway strip; equal to the elevation of the nearest point on the centre line of the runway or its extension, to the edge of the graded area.

4.1.3.3 Recommendation.— The slopes of any portion of the strip beyond the graded area should not exceed an upward slope of 5% as measured from the edge of the graded area perpendicular to the runway. This upward slope will extend to intersect with the transitional surface.

4.1.3.4 Standard.— The slope of a transitional surface shall be measured in a vertical plane perpendicular to the extended centre line of each runway.

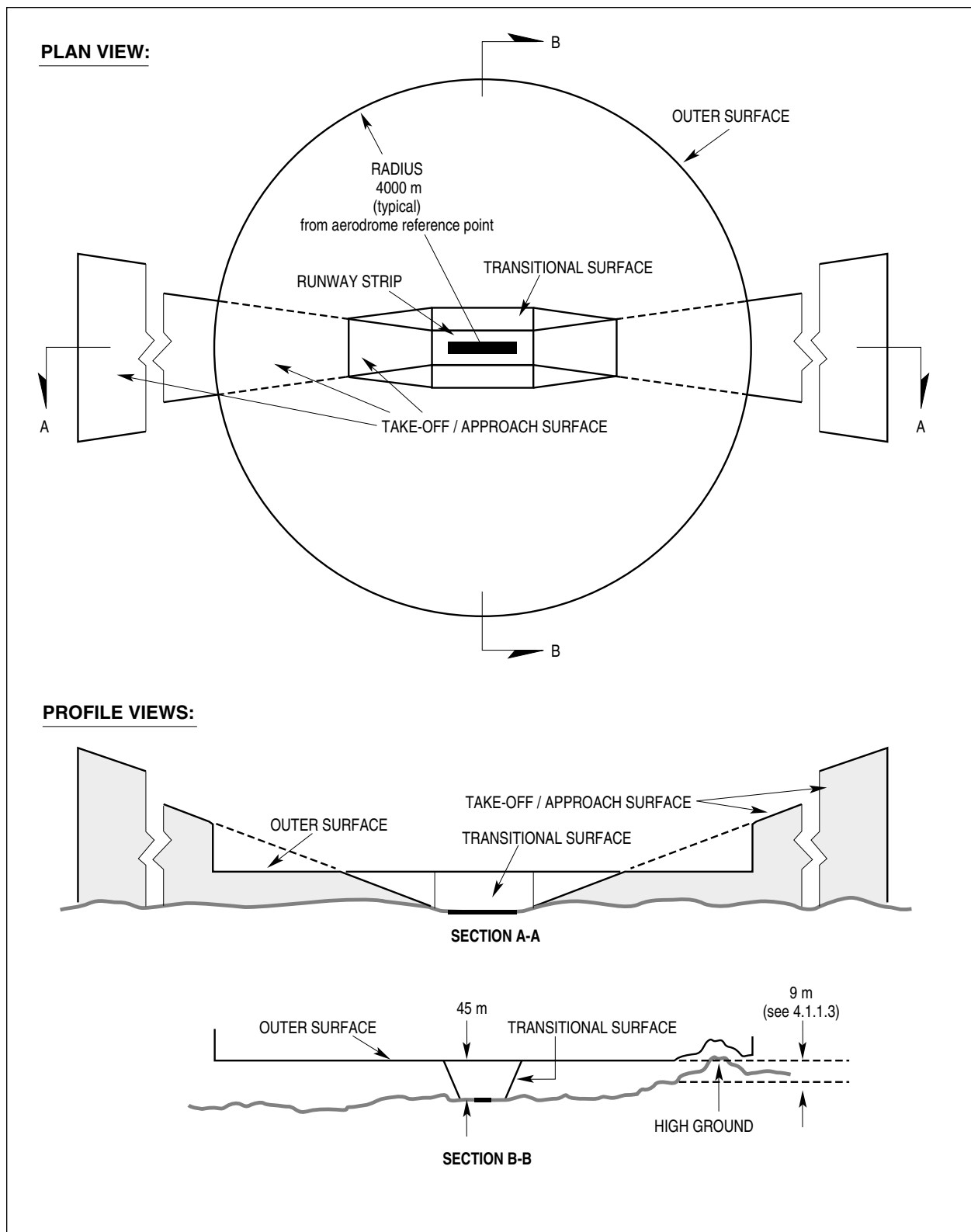

Figure 4-1. Obstacle Limitation Surfaces

4.2 OBSTACLE LIMITATION REQUIREMENTS

Note. 1.— The requirements for obstacle limitation surfaces are specified on the basis of the intended use of a runway, i.e. type of approach and take-off or landing, and are intended to be applied when such use is made of the runway.

Note 2.— A runway is categorized by the following types of approach:

- non-instrument,
- non-precision,
- precision.

4.2.1 GENERAL

4.2.1.1 Standard.— An outer surface shall be established where required for the protection of airspace for aircraft conducting a circling procedure or manoeuvring in the vicinity of an aerodrome.

4.2.2 NON-INSTRUMENT RUNWAYS

4.2.2.1 Standard.— The following obstacle limitation surfaces shall be established for all non-instrument runways:

- take-off/approach surfaces; and
- transitional surfaces, except as specified in 4.2.2.4 (c).

4.2.2.2 Standard.— An outer surface shall be established for a runway which does not have an straight-in instrument approach but where there is a published circling approach procedure to that runway or where it is necessary, in the view of the certifying authority, to protect airspace for aircraft manoeuvring in the vicinity of the airport.

4.2.2.3 Standard.— The heights of these surfaces shall not be greater than, and their other dimensions not less than, those specified in Table 4-1, except in the case of the outer surface.

Note.— It may not be necessary to protect the airspace from obstacles in all sectors of the outer surface at certain airports. In these cases, it is possible to establish an outer surface with non-uniform dimensions, provided procedures are established to ensure that aircraft do not fly in these sectors.

4.2.2.4 Standard.— The slope of the transitional surface where the code number is 1 or 2 shall not exceed the appropriate value shown in Table 4-1 except where:

- a) the slope cannot be established due to topographic or unavoidable natural obstructions;
- b) the aerodrome is used only in VMC; and
- c) one of the following measures is undertaken and approved by the certifying authority:
 - i) the width of the runway strip is increased to at least 45 m from the centre line of the runway and a transitional surface is established with a slope not exceeding 33% (1:3); or
 - ii) the width of the runway strip is increased to at least 60 m from the centre line of the runway where the code number is 2 and a transitional surface is established with a slope not exceeding 50% (1:2); or
 - iii) the width of the runway strip is increased to at least:
 - 60 m from the centre line of the runway where the code number is 1;
 - 75 m from the centre line of the runway where the code number is 2.

4.2.2.5 Standard.— The slope of the transitional surface where the code number is 3 or 4 shall not exceed the appropriate value shown in Table 4-1.

4.2.2.6 Standard.— New objects or extensions of existing objects shall not be permitted above a take-off/approach or transitional surface except when, in the opinion of the certifying authority, the new object or extension would be shielded by an existing immovable object.

Note.— Circumstances in which the shielding principle may reasonably be applied are described in the ICAO Airport Services Manual, Part 6.

4.2.2.7 Recommendation.— New objects or extensions of existing objects should not be permitted above the outer surface except when, in the opinion of the certifying authority, the object would be shielded by an existing immovable object, or after aeronautical study it is determined that the object would not adversely affect the safety or significantly affect the regularity of operations of aircraft.

4.2.2.8 Recommendation.— In considering proposed construction, account should be taken of the possible future development of an instrument runway and consequent requirement for more stringent obstacle limitation surfaces.

4.2.3 NON-PRECISION APPROACH RUNWAYS

Note.— See 8.6 for information regarding siting and construction of equipment and installations on operational areas.

4.2.3.1 Standard.— The following obstacle limitation surfaces shall be established for a non-precision approach runway:

- outer surface;
- take-off/approach surface; and
- transitional surfaces.

4.2.3.2 Standard.— The heights and slopes of the surfaces shall not be greater than, and their other dimensions not less than, those specified in Table 4-1.

Table 4-1. Dimensions and Slopes of Obstacle Limitation Surfaces

SURFACE and DIMENSIONS	RUNWAY TYPE / CODE NUMBER								
	Non-instrument				Non-precision approach			Precision approach Cat I	
	(1)				(2)			(3)	
	Code number				Code number			Code number	
	1	2	3	4	1&2	3	4	1&2	3&4
OUTER SURFACE									
- Height	45m	45m	45m	45m	45m	45m	45m	45m	45m
- Radius	4000 m	4000 m	4000 m	4000 m	4000 m	4000 m	4000 m	4000 m	4000 m
TAKE-OFF/APPROACH SURFACE									
- Length of Inner Edge	30 m	30 m	45 m	75 m	45 m	75 m	150 m	75 m	150 m
- Distance from threshold	30 m	60 m	60 m	60 m	60 m	60 m	60 m	60 m	60 m
- Divergence (minimum each side)	10%	10%	10%	10%	10%	15%	15%	15%	15%
- Length (minimum)	2500 m	2500m	2500m	2500m	2500 m	3000 m	3000 m	15000m	15000m
- Slope (maximum)	5% (1:20)	4% (1:25)	2.5% (1:40)	2.5% (1:40)	3.33% (1:30)	2.5% (1:40)	2.5% (1:40)	2.5% (1:40)	2.0% (1:50)
TRANSITION SURFACE									
- Slope (maximum)	20.0% (1:5)	20.0% (1:5)	14.3% (1:7)	14.3% (1:7)	14.3% (1:7)	14.3% (1:7)	14.3% (1:7)	14.3% (1:7)	14.3% (1:7)

4.2.3.3 Recommendation.— Where practicable, the slope of the take-off/approach surface should be 2.0%.

4.2.3.4 Standard.— New objects or extensions of existing objects shall not be permitted above a take-off/approach surface within 3000 m of the inner edge or above a transitional surface except when, in the opinion of the certifying authority, the new object or extension would be shielded by an existing immovable object.

Note.— *Circumstances in which the shielding principle may reasonably be applied are described in the ICAO Airport Services Manual, Part 6.*

4.2.3.5 Recommendation.— New objects or extensions of existing objects should not be permitted above the take-off/approach surface beyond 3000 m from the inner edge or above the outer surface except when, in the opinion of the certifying authority, the object would be shielded by an existing immovable object, or after aeronautical study it is determined that the object would not adversely affect the safety or significantly affect the regularity of operations of aircraft.

4.2.3.6 Recommendation.— Existing objects above any of the surfaces required by 4.2.3.1 should as far as practicable be removed except when, in the opinion of the certifying authority, the object is shielded by an existing immovable object, or after aeronautical study it is determined that the object would not adversely affect the safety or significantly affect the regularity of operations of aircraft.

Note.— *Because of transverse or longitudinal slopes on a strip, in certain cases the inner edge or portions of the inner edge of the take-off/approach surface may be below the corresponding elevation of the strip. It is not intended that the strip be graded to conform with the inner edge of the take-off/approach surface, nor is it intended that terrain or objects which are above the take-off/approach surface beyond the end of the strip, but below the level of the strip, be removed unless it is considered they may endanger aeroplanes.*

4.2.4 PRECISION APPROACH RUNWAYS

Note 1.— *See 8.6 for information regarding siting and construction of equipment and installations on operational areas.*

Note 2.— *Guidance on obstacle limitation surfaces for precision approach runways is given in the ICAO Airport Services Manual, Part 6.*

4.2.4.1 Standard.— The following obstacle limitation surfaces shall be established for a precision approach runway category I:

- outer surface;
- take-off/approach surface; and
- transitional surfaces.

Note.— *Obstacle limitation surfaces for precision approach runways categories II & III are established in accordance with specifications contained in TP 1490, Manual of All Weather Operations.*

4.2.4.2 Standard.— The heights and slopes of the surfaces shall not be greater than, and their other dimensions not less than, those specified in Table 4-1.

4.2.4.3 Recommendation.— Where practicable, for new runways where the code number is 3 or 4, the slope of the take-off/approach surface should be 1.66% for the first 3000 m and 2.0% thereafter for a total length of 15000 m.

4.2.4.4 Standard.— Fixed objects shall not be permitted above the take-off/approach surface, or the transitional surface, except for frangibly mounted objects which because of their function must be located on the strip. Mobile objects shall not be permitted above these surfaces during the use of the runway for landing.

4.2.4.5 Standard.— New objects or extensions of existing objects shall not be permitted above a take-off/approach surface or a transitional surface except when, in the opinion of the certifying authority, the new object or extension would be shielded by an existing immovable object.

Note.— *Circumstances in which the shielding principle may reasonably be applied are described in the ICAO Airport Services Manual, Part 6.*

4.2.4.6 Recommendation.— New objects or extensions of existing objects should not be permitted above the outer surface except when, in the opinion of the certifying authority, an object would be shielded by an existing immovable object, or after aeronautical study it is determined that the object would not adversely affect the safety or significantly affect the regularity of operations of aircraft.

4.2.4.7 Recommendation.— Existing objects above a take-off/approach surface, a transitional surface, and the outer surface should as far as practicable be removed except when, in the opinion of the certifying authority, an object is shielded by an existing immovable object, or after aeronautical study it is determined that the object would not adversely affect the safety or significantly affect the regularity of operations of aircraft.

Note.— *Because of transverse or longitudinal slopes on a strip, in certain cases the inner edge or portions of the inner edge of the take-off/approach surface may be below the corresponding elevation of the strip. It is not intended that the strip be graded to conform with the inner edge of the approach surface, nor is it intended that terrain or objects which are above the approach surface beyond the end of the strip, but below the level of the strip, be removed unless it is considered they may endanger aircraft.*

4.3 OTHER OBJECTS

4.3.1 GENERAL

4.3.1.1 Recommendation.— Objects which do not project through the take-off/approach surface but which would nevertheless adversely affect the optimum siting or performance of visual or non-visual aids should, as far as practicable, be removed.

4.3.1.2 Recommendation.— Anything which in the opinion of the certifying authority after aeronautical study, endanger aircraft on the movement area or in the air within the limits of the outer surface should be regarded as an obstacle and should be removed in so far as practicable.

Note.— *In certain circumstances, objects that do not project above any of the surfaces enumerated in 4.1 may constitute a hazard to aircraft as, for example, where there are one or more insolated isolated objects in the vicinity of aerodrome.*

4.3.1.3 Standard.— Any transportation corridor underlying an Obstacle Limitation Surface shall be considered as an object. As a minimum, 4.3 m shall be allowed above the crown of a road and for a railway, 6 m above the top of the rails. The height to be allowed above a waterway, river, canal, etc. shall be established by Aeronautical Study.

CHAPTER 5. VISUAL AIDS FOR NAVIGATION

5.1 INDICATORS AND SIGNALLING DEVICES

5.1.1 WIND DIRECTION INDICATORS

Application

5.1.1.1 Standard.— An aerodrome shall be equipped with at least one wind direction indicator.

Location

5.1.1.2 Standard.— A wind direction indicator shall be located so as to be visible from aircraft in flight or on the movement area and in such a way as to be free from the effects of air disturbances caused by nearby objects.

5.1.1.3 Recommendation.— Aerodromes with runways greater than 1200 m should have a wind direction indicator located at each end of the runway at a point approximately 60 m outwards from the runway edge and approximately 150 m inwards from the approach end.

Note.— Where runways intersect near the threshold or where parallel runways are separated by 180 m or less between centre lines, one wind direction indicator may be suitably located to serve both runways.

5.1.1.4 Recommendation.— Aerodromes with runways 1200 m or less in length should have a wind direction indicator centrally located on the aerodrome except that at aerodromes with only one runway the wind direction indicator should be centrally located along the runway and approximately 60 m from the edge.

Note.— If a location near the apron would be of greater value to the pilot in selecting the runway for takeoff at locations where airport advisory service is not provided such a site may be selected in lieu of the centre of the aerodrome or runway complex. In such cases, the possible effects of buildings causing false wind indications need to be considered.

Characteristics

5.1.1.5 Standard.— The height of wind direction indicators shall not exceed a height of 7.5 m when located in the runway strip.

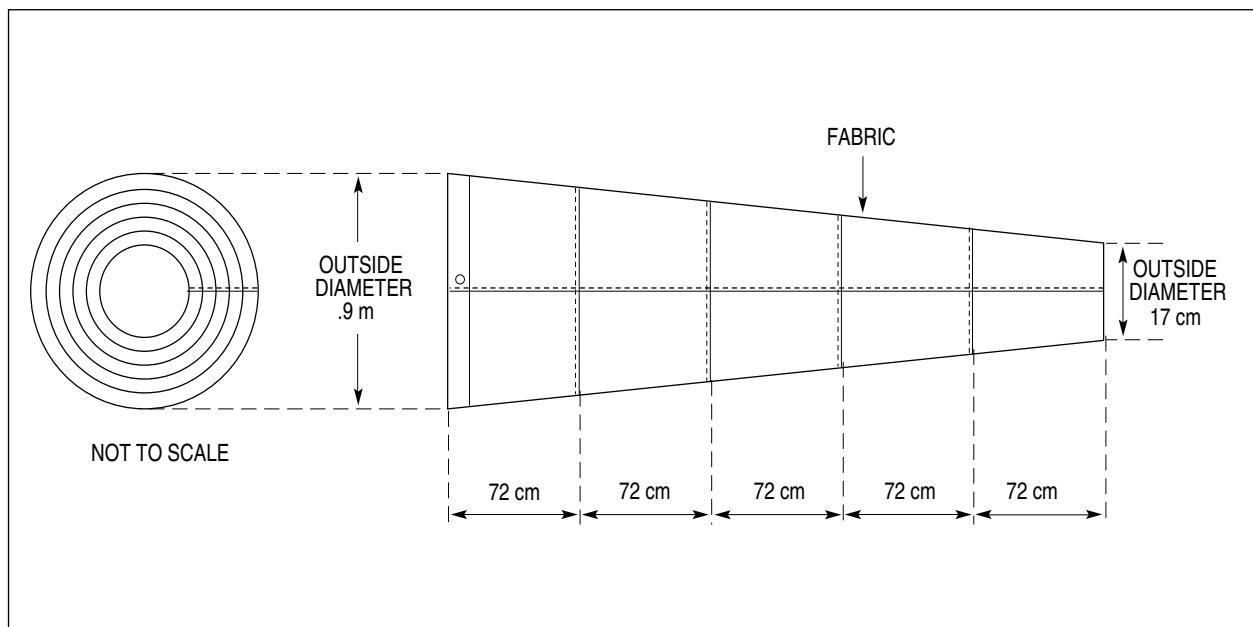

Figure 5-1. Wind Direction Indicator

5.1.1.6 Recommendation.— The wind direction indicator should be in the form of a truncated cone made of fabric and should have a length of not less than 3.6 m and a diameter, at the larger end, of not less than 0.9 m. It should be constructed so that it gives a clear indication of the direction of the surface wind and a general indication of the wind speed. The colour or colours should be so selected as to make the wind direction indicator clearly visible and understandable from a height of at least 300 m, having regard to background. Where practicable, a single colour, preferably white or orange, should be used. Where a combination of two colours is required to give adequate conspicuity against changing backgrounds, they should preferably be orange and white, red and white, or black and white, and should be arranged in five alternate bands, the first and last bands being the darker colour. (See Figure 5-1)

5.1.1.7 Standard.— Provision shall be made for illuminating at least one wind indicator at an aerodrome intended for use at night.

5.2 MARKINGS

5.2.1 GENERAL

Interruption of runway markings

5.2.1.1 Standard.— At an intersection of two (or more) runways the marking of the more important runway, except for the runway side stripe marking, shall be displayed and the markings of the other runway(s) shall be interrupted. The runway side stripe marking of the more important runway may be either continued across the intersection or interrupted.

5.2.1.2 Standard.— The order of importance of runways for the display of runway markings shall be as follows:

- 1st – precision approach runway;
- 2nd – non-precision approach runway; and
- 3rd – non-instrument runway.

5.2.1.3 Standard.— At an intersection of a runway and taxiway the markings of the runway shall be displayed and the markings of the taxiway interrupted, except that runway side stripe

markings may be interrupted.

Note.— See 5.2.8.5 regarding the manner of connecting runway and taxiway centre line markings.

Colour

5.2.1.4 Standard.— Runway markings shall be white.

5.2.1.5 Standard.— Taxiway markings, apron taxiway markings, and aircraft stand taxilane markings shall be yellow.

5.2.1.6 Recommendation.— Parking area boundary lines, vehicle corridors, and apron pedestrian walkway markings should be white.

Note 1.— It has been found that on pavement surfaces of light colour, the conspicuity of both white and yellow markings can be improved by outlining them in black.

Note 2.— Where it is necessary to increase the visibility of a parking area boundary line, a red line equal in width may be painted on the apron side of the white line, thus reinforcing that the parking of vehicles and/or equipment beyond the line, is prohibited.

Note 3.— It is preferable that the risk of uneven friction characteristics on markings be reduced in so far as practical by the use of a suitable kind of paint.

5.2.1.7 Standard.— Markings are described in this chapter as solid areas. They may consist of either solid colour or striated, employing a series of longitudinal painted lines. Where striated markings are used they shall cover the same area as described for the solid marking and the width of the paint lines and the spacing between them should be of approximately the same size giving an overall effect of at least 50 % paint coverage.

Note.— It has been found that stripes of approximately 15 cm width are suitable.

Unpaved taxiways

5.2.1.8 Recommendation.— An unpaved taxiway should be provided, so far as practicable, with the markings prescribed for paved taxiways.

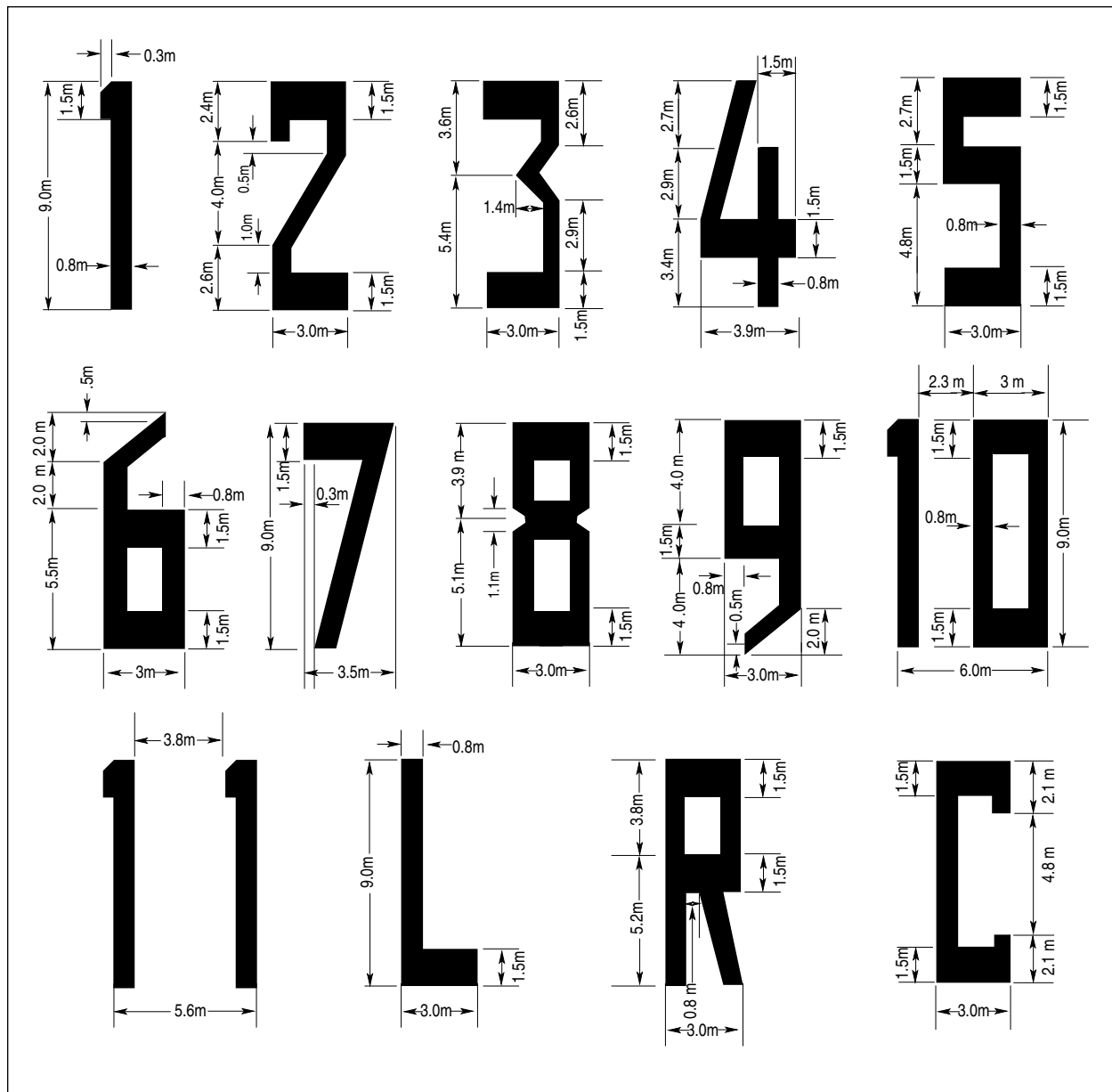

Figure 5-2. Form and proportion of runway designation marking

5.2.2 RUNWAY DESIGNATION MARKINGS

Application

5.2.2.1 Standard.— A runway designation marking shall be provided at the threshold of a paved runway.

5.2.2.2 Recommendation. — A runway designation marking should be provided, so far as practicable, at the threshold of an unpaved runway.

Location

5.2.2.3 Standard.— A runway designation marking shall be located beyond the threshold as shown in Figure 5-5 as appropriate.

Note.— If the runway threshold is displaced from the extremity of the runway, a location sign showing the designation of the runway may be provided for aeroplanes taking off (see 5.4.3).

Characteristics

5.2.2.4 Standard.— A runway designation marking shall consist of a two-digit number and on parallel runways shall be supplemented with a letter. On a single runway, dual parallel runways and triple parallel runways the two-digit number shall be the whole number nearest the one-tenth of the magnetic North when viewed from the direction of approach. On four or more parallel runways, one set of adjacent runways shall be numbered to the nearest one-tenth magnetic azimuth and the other set of adjacent runways numbered to the next nearest one-tenth of the magnetic azimuth. When the above rule would give a single digit number, it shall be preceded by a zero.

5.2.2.5 Standard.— In cases of airports located within the area of compass unreliability the runway designation requirements prescribed in para. 5.2.2.4 shall apply except that TRUE azimuth rather than magnetic azimuth shall be used.

5.2.2.6 Standard.— In the case of parallel runways, each runway designation number shall be supplemented by a letter as follows, in the order shown from left to right when viewed from the direction of approach:

- for two parallel runways: "L" "R";
- for three parallel runways: "L" "C" "R";
- for four parallel runways: "L" "R" "L" "R"

5.2.2.7 Standard.— The numbers and letters shall be in the form and proportion shown in Figure 5–2. The dimensions shall be not less than those shown in Figure 5–2.

5.2.3 RUNWAY CENTRE LINE MARKING

Application

5.2.3.1 Standard.— A runway centre line marking shall be provided on a paved runway.

Location

5.2.3.2 Standard.— A runway centre line marking shall be located along the centre line of the runway between the runway designation markings as shown in Figure 5–5, except when interrupted in compliance with 5.2.1.1.

Characteristics

5.2.3.3 Standard.— A runway centre line marking shall consist of a line of uniformly spaced stripes and gaps. The length of a stripe plus a gap shall be not less 50 m or more than 75 m. The length of each stripe shall be at least equal to the length of the gap or 30 m, whichever is greater.

5.2.3.4 Recommendation.— The length of a stripe plus gap should be 60 m.

5.2.3.5 Standard.— The width of the stripes shall be at least 0.9 m.

5.2.3.6 Recommendation.— The width of the centre line marking should be 2.3 m where the runway code number is 3 or 4.

5.2.4 THRESHOLD MARKING

Application

5.2.4.1 Standard.— A threshold marking shall be provided at the threshold of a paved runway where the width is 23 m or greater.

5.2.4.2 Recommendation.— A threshold marking should be provided at the threshold of a paved runway where the width is less than 23 m.

5.2.4.3 Recommendation.— A threshold marking should be provided, so far as practicable, at the thresholds of an unpaved runway.

Location

5.2.4.4 Standard.— The stripes of the threshold marking shall commence 6 m from the threshold.

5.2.4.5 Standard.— Where a runway threshold is located on another runway (for example a "T" configuration), the threshold marking shall be located at a distance from the threshold equal to the width of the other runway.

Characteristics

5.2.4.6 Standard.— A runway threshold marking shall consist of a pattern of longitudinal stripes of uniform dimensions disposed symmetrically about the centre line of a runway as shown in Figure 5–3. The number of stripes shall

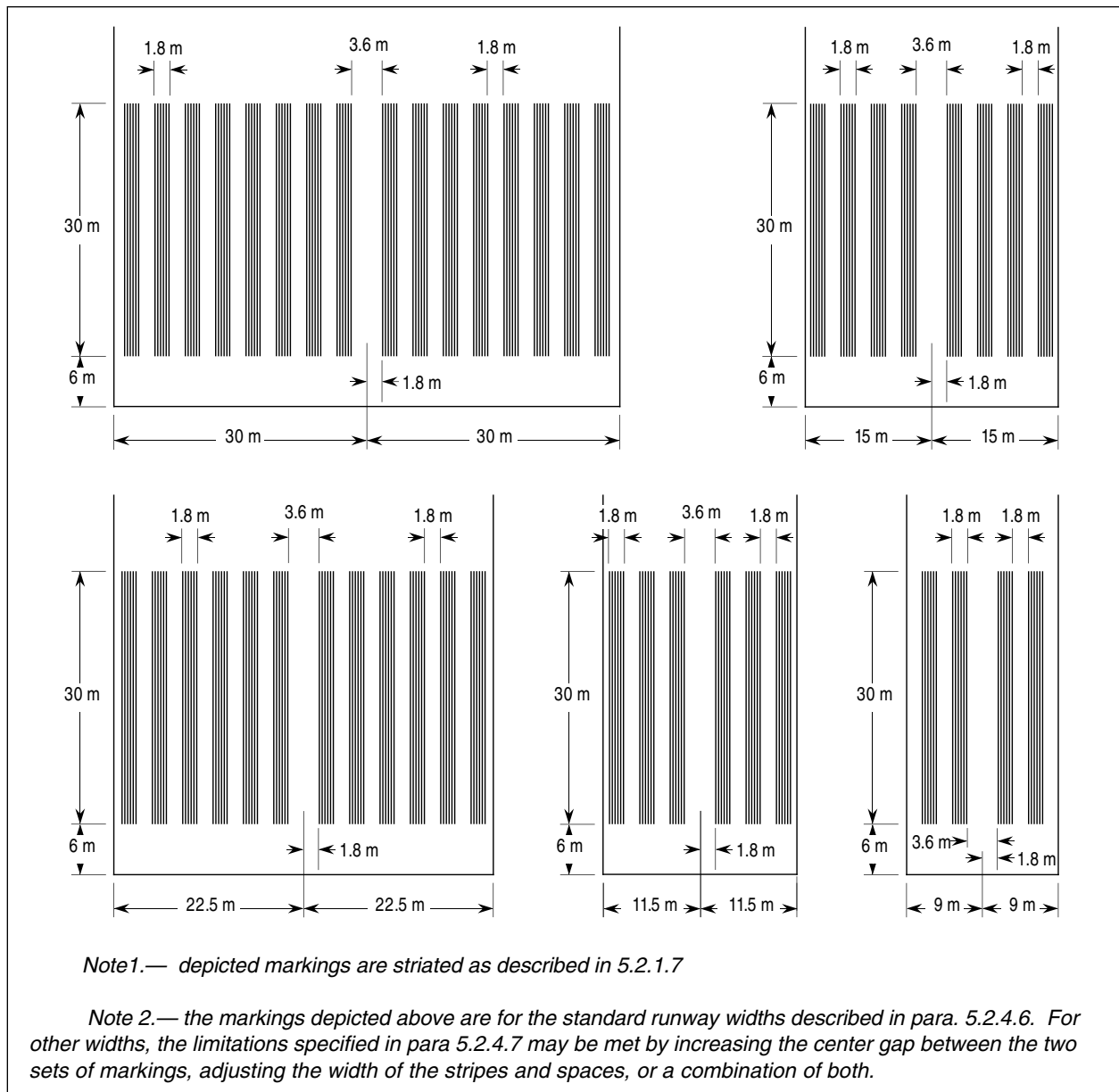

Figure 5-3. Threshold Markings

be in accordance with the runway width as follows:

Runway width	Number of stripes
18 m	4
23 m	6
30 m	8
45 m	12
60 m	16

5.2.4.7 Standard.— The stripes shall extend laterally to within 3 m of the edge the runway. The stripes shall be separated into two

groups separated by at least 3.6 m. The stripes shall be 30 m long and approximately 1.80 m wide with spacings of approximately 1.80 m between them.

TRANSVERSE STRIPE

5.2.4.8 Standard.— Where the extremity of a runway is not square with the runway centre line or where a runway threshold is permanently displaced from the extremity of a runway, a transverse stripe as shown in Figure 5–4 shall be added to the threshold marking.

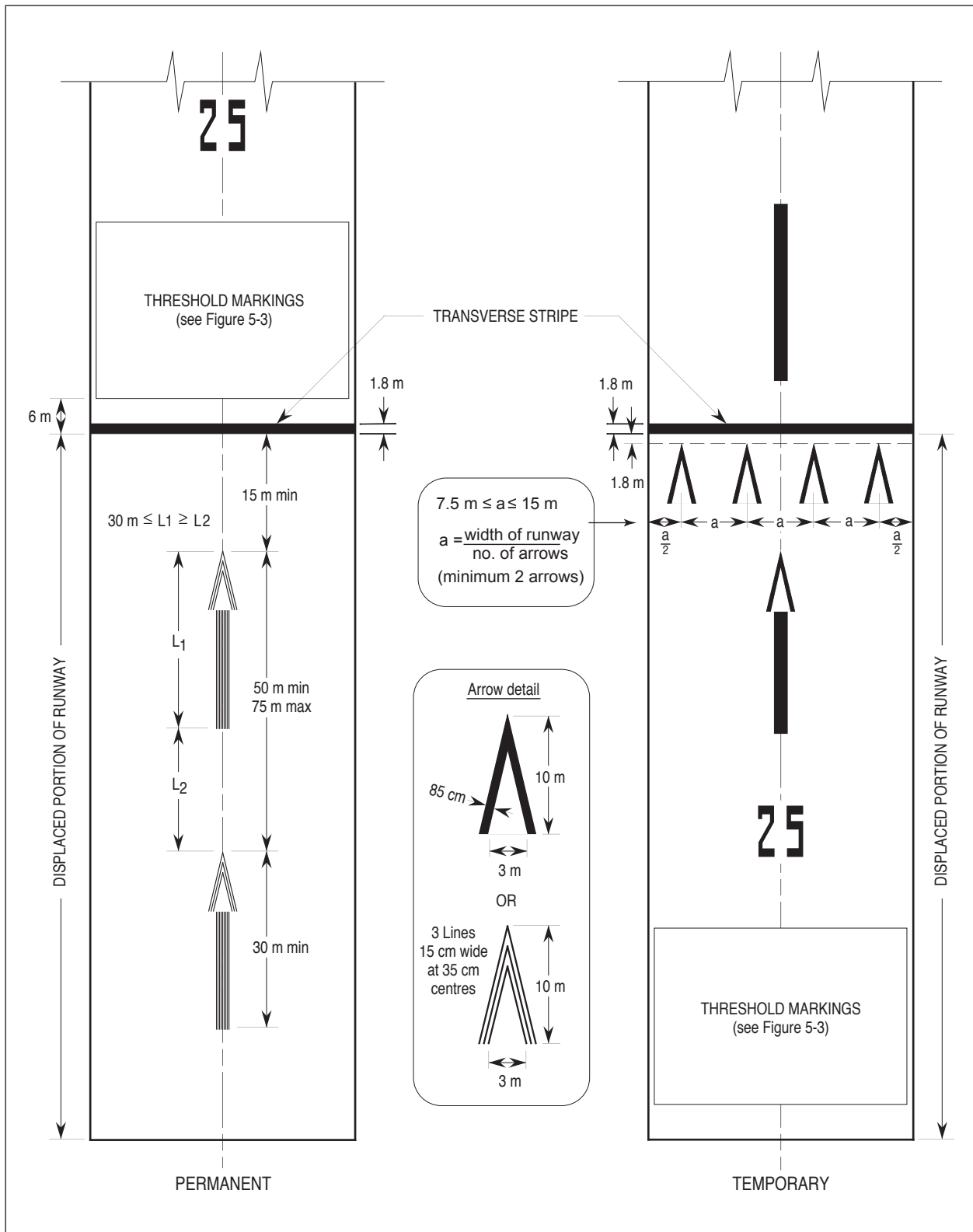

Figure 5-4. Displaced Runway Threshold Markings

5.2.4.9 Recommendation.— Where a runway threshold is temporarily displaced from the extremity of a runway, a transverse stripe as shown in Figure 5-4 should be added to the threshold marking.

Note.— Where the threshold is displaced for only a short period of time, it has been found satisfactory to use flags and/or cones of a conspicuous colour to mark the threshold location when painting is not practicable.

5.2.4.10 Standard.— A transverse stripe shall be not less than 1.80 m wide.

ARROWS

5.2.4.11 Standard.— Where a runway threshold is permanently displaced arrows conforming to Figure 5-4 shall be provided on the portion of the runway before the displaced threshold except that:

- a) when the portion of the runway is unfit for the surface movement of aircraft, closed markings as described in 7.1.1 shall be provided; or
- b) when the portion of the runway is intended to be maintained as a stopway, chevron markings as described in 7.3.1 shall be provided.

5.2.4.12 Standard.— When a runway threshold is temporarily displaced from the normal position, it shall be marked as shown in Figure 5-4. All markings prior to the displaced threshold shall be obscured and the runway centre line marking

converted to arrows except that when the portion of the runway is unfit for the surface movement of aircraft, closed markings as described in 7.1.1 shall be provided.

Note.— In the case where a threshold is temporarily displaced for only a short period of time, markers in the form and colour of a displaced threshold marking may be used, rather than attempting to paint this marking on the runway.

5.2.5 AIMING POINT MARKING

Note.— Aiming point markings were previously described as fixed distance markings.

Application

5.2.5.1 Standard.— An aiming point marking shall be provided at each end of a paved runway where the code number is 3 or 4.

5.2.5.2 Recommendation.— An aiming point marking should be provided at each end of a paved instrument runway where the code number is 1 or 2.

Location

5.2.5.3 Standard.— The aiming point marking shall commence no closer to the threshold than the distance indicated in the appropriate column of Table 5-1.

Table 5-1. Location and Dimensions of the Aiming Point Marking

Location and Dimensions	Code Number			
	1	2	3	4
Distance from threshold to beginning of marking	150 m	250 m	300 m	400 m
Length of stripe ^a	30 - 45 m	30 - 45 m	45 - 60 m	45 - 60 m
Width of stripe	4 m	6 m	6 - 10 m ^b	6 - 10 m ^b
Lateral spacing between inner sides of stripes	6 m	9 m	18 - 22.5 m	18 - 22.5 m

a. The greater dimensions of the specified ranges are intended to be used where increased conspicuity is required

b. The lateral spacing may be varied within these limits to minimize the contamination of the marking by rubber deposits.

Characteristics

5.2.5.4 Standard.— An aiming point marking shall consist of two conspicuous stripes. The dimensions of the stripes and the lateral spacing between their inner sides should be in accordance with the provisions of the appropriate column of Table 5–1.

5.2.6 TOUCHDOWN ZONE MARKING

Application

5.2.6.1 Standard.— A touchdown zone marking shall be provided at each end of a paved runway where the code number is 3 or 4.

5.2.6.2 Standard.— A touchdown zone marking shall be provided at each end of a paved precision approach runway where the code number is 2.

Location and characteristics

5.2.6.3 Standard.— A touchdown zone marking shall consist of pairs of rectangular markings symmetrically disposed about the runway centre line with the number of such pairs related to the landing distance available and, where the marking is to be displayed at both the approach directions of a runway, the distance between the thresholds, as follows:

<u>Runway length</u>	<u>Pair(s) of markings</u>
less than 900 m	1
900 m up to but not including 1200 m	2
1200 m up to but not including 1500 m	3
1500 m up to but not including 2400 m	4
2400 m or more	6

5.2.6.4 Standard.— A touchdown zone marking shall conform to the pattern shown in Figure 5–5. The markings shall not be less than 22.5 m long and 3 m wide. The lateral spacing between the inner sides of the rectangles shall be

equal to that of the aiming point marking where provided. Where an aiming point is not provided, the lateral spacing between the inner sides of the rectangles shall correspond to the lateral spacing specified for the aiming point marking in Table 5–1. The pairs of markings shall be provided at longitudinal spacings of 150 m beginning from the threshold except that pairs of touchdown zone markings coincident with or located within 50 m of an aiming point marking shall be deleted from the pattern.

5.2.6.5 Recommendation.— Where operationally necessary, an additional pair of touchdown zone marking stripes should be provided on a code 2 runway, 150 m beyond the beginning of the aiming point marking.

5.2.7 RUNWAY SIDE STRIPE MARKING

Application

5.2.7.1 Standard.— A runway side stripe marking shall be provided between the thresholds of a paved runway where there is a lack of contrast between the runway edges and the shoulders or the surrounding terrain.

Location

5.2.7.2 Standard.— A runway side stripe marking shall consist of a stripe placed along each edge of the runway. For runways 60 m and less in width, the marking shall be placed with the outer edge of each stripe approximately on the edge of the runway.

5.2.7.3 Recommendation.— Where the runway is greater than 60 m in width, the stripes should be located 30 m from the runway centre line.

Characteristics

5.2.7.4 Recommendation.— A runway side stripe should have an over-all width of at least 0.9 m on runways 30 m or more in width and at least 0.45 m on narrower runways.

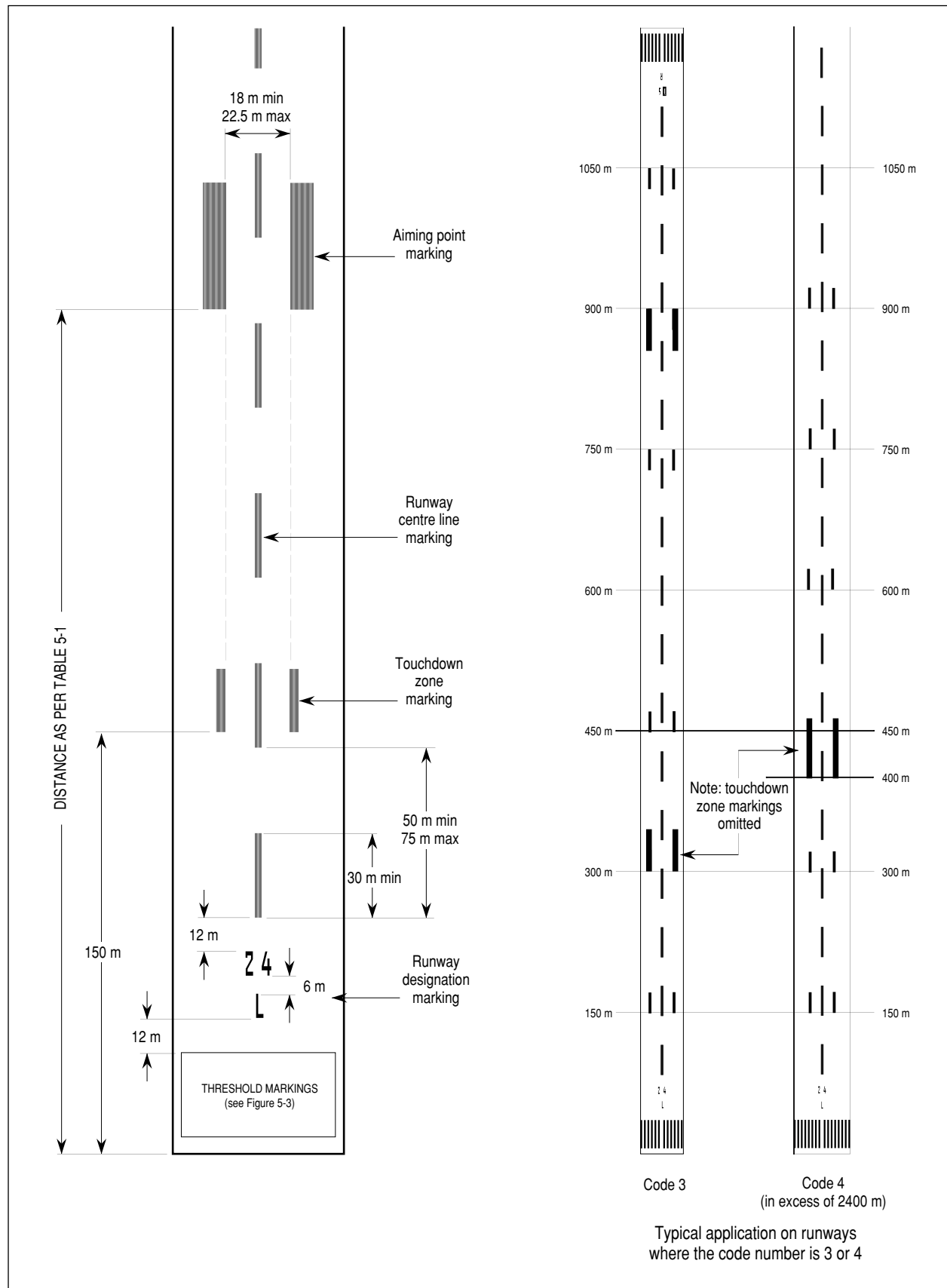

Figure 5-5. Runway Markings

5.2.8 TAXIWAY CENTRE LINE MARKING

Application

5.2.8.1 Standard.— A taxiway centre line marking shall be provided on a paved taxiway where the code number is 3 or 4 in such a way as to provide guidance from the runway centre line to a point on the apron where aircraft stand markings commence.

5.2.8.2 Recommendation.— Taxiway centre line markings should be provided on a paved taxiway where the code number is 1 or 2 in such a way as to provide guidance from the runway centre line to the point on the apron where aircraft stand markings commence.

5.2.8.3 Standard.— Taxiway centre line marking shall be provided on a paved runway when the runway is part of a standard taxi route, and where the taxiway centre line is not coincident with the runway centre line.

Location

5.2.8.4 Standard.— On a straight section of taxiway, the taxiway centre line marking shall be located along the taxiway centre line. On a taxiway curve the marking shall continue from the straight portion of the taxiway at a constant distance from the outside edge of the curve.

Note. — See 3.4.1.6 and Figure 3–1.

5.2.8.5 Recommendation.— At an intersection of a taxiway with a runway where the taxiway serves as an exit from the runway, the taxiway centre line marking should be curved into the runway centre line marking as shown in Figure 5–6. The taxiway centre line marking should be extended parallel to the runway centre line marking for a distance of at least 60 m beyond the point of tangency where the code number is 3 or 4, and for a distance of at least 30 m where the code number is 1 or 2.

5.2.8.6 Recommendation.— Where a taxiway centre line marking is provided on a runway in accordance with 5.2.8.3 the marking should be located on the centre of the designated taxiway.

Characteristics

5.2.8.7 Standard.— A taxiway centre line marking shall be at least 15 cm in width and continuous in length except where it intersects a taxi-holding position marking or taxiway intersection marking as shown in Figure 5-6, or when interrupted by an information marking (see 5.2.16.6).

5.2.9 TAXI-HOLDING POSITION MARKING

Application

5.2.9.1 Standard.— A taxi-holding position marking shall be displayed along a taxi-holding position.

Note.— See 5.4.2 concerning the provision of a holding position sign.

Location

5.2.9.2 Standard.— A taxi holding position marking at a taxiway/runway intersection shall be located at a distance from the runway centre line as specified in Table 3.2 or 3.3.

5.2.9.3 Standard.— A taxi-holding position marking at a runway/runway intersection shall be located at a distance from the runway edge as specified in 3.5.2.4.

Characteristics

5.2.9.4 Standard.— At an intersection of a taxiway and a non-instrument, non-precision approach, precision approach category I or take-off runway, the taxi-holding position marking shall be as shown in Figure 5–6, pattern A.

5.2.9.5 Standard.— Where a single taxi-holding position is provided at an intersection of a taxiway and a precision approach runway category II or III, the taxi-holding position marking shall be as shown in Figure 5–6, pattern A. Where two or three taxi-holding positions are provided at such an intersection, the taxi-holding position marking closest to the runway shall be as shown in Figure 5–6, pattern A and the markings furthest from the runway shall be as shown in Figure 5–6, pattern B.

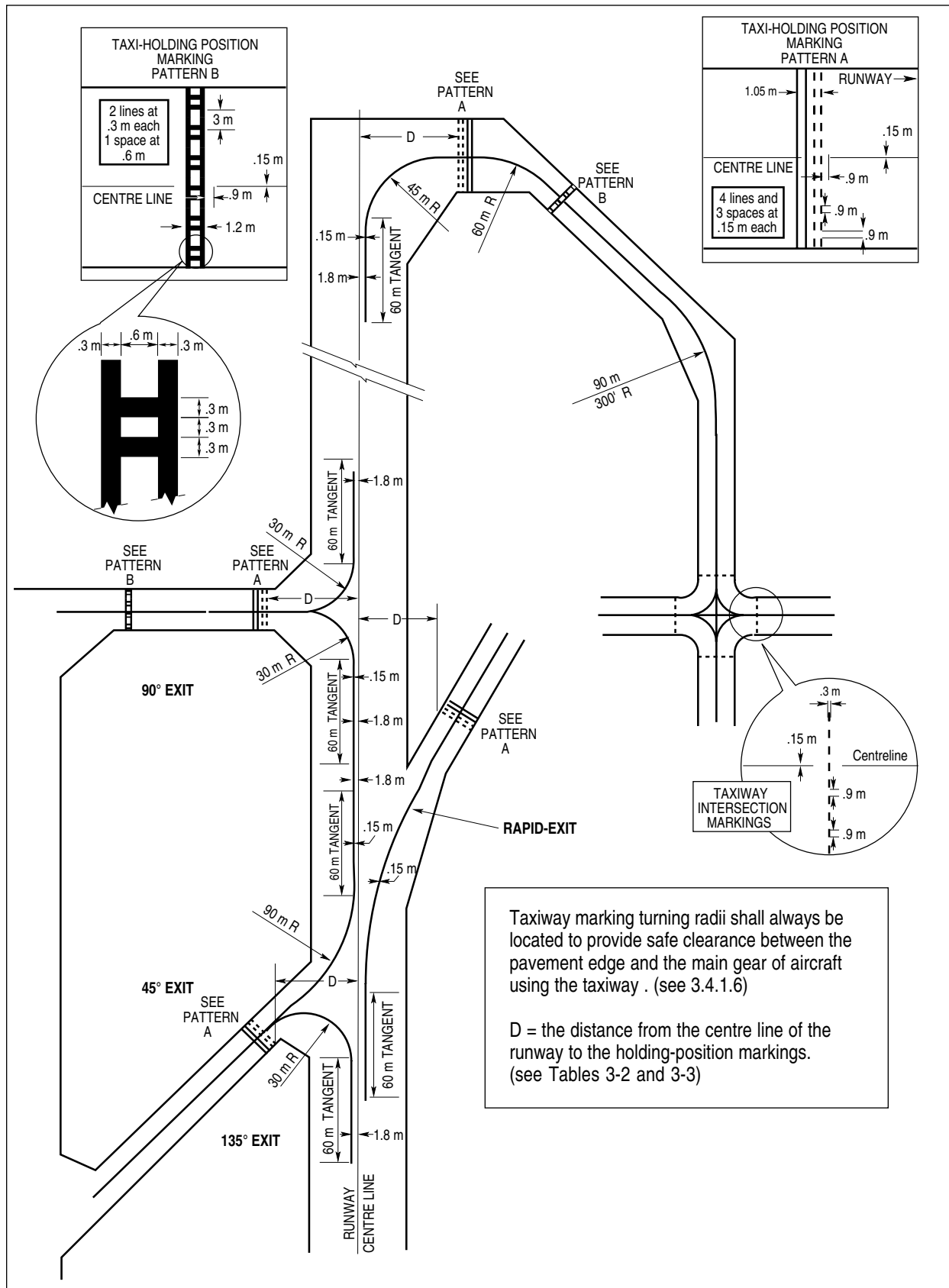

Figure 5-6. Taxiway Markings

5.2.9.6 Recommendation.— Where a pattern B taxi–holding position marking is located on an area where it would exceed 60 m in length, the term "CAT II" or "CAT III" as appropriate should be marked on the surface at the ends of the taxi–holding position marking and at equal intervals of 45 m maximum between successive marks. The letters should be not less than 1.8 m high and should be placed not more than 0.9 m beyond the holding position marking.

5.2.9.7 Standard.— The taxi–holding position marking displayed at a runway/runway intersection shall be as shown in Figure 5–6, pattern A.

5.2.9.8 Standard.— The taxi–holding position marking shall be at right angles to the taxiway centre line.

5.2.10 TAXIWAY INTERSECTION MARKING

Application

5.2.10.1 Recommendation.— A taxiway intersection marking should be displayed at an intersection of two paved taxiways where it is desired to designate a specific holding limit.

Location

5.2.10.2 Recommendation.— A taxiway intersection marking should be located across a taxiway at sufficient distance from the near edge of an intersecting taxiway to ensure safe clearance between taxiing aircraft. It should be coincident with a stop bar or taxiway intersection lights, where provided.

Characteristics

5.2.10.3 Standard.— A taxiway intersection marking shall consist of a single broken line as shown in Figure 5–6.

5.2.11 AIRCRAFT STAND TAXILANE MARKING

Application

5.2.11.1 Standard.— An aircraft stand

taxilane marking shall be provided on an aircraft stand taxilane in such a way as to provide guidance from the taxiway centre line to a point on the apron where aircraft stand markings commence.

Location

5.2.11.2 Standard.— On a straight section of aircraft stand taxilane, the marking shall be located along the centre line of the aircraft stand taxilane. On a curved portion, the marking shall continue from the straight portion of the taxilane at a constant distance from the outside edge of the curve.

Characteristics

5.2.11.3 Standard.— An aircraft stand taxilane marking shall be at least 15 cm in width and continuous in length except when interrupted by an information marking (see 5.2.16.6).

5.2.12 AIRCRAFT STAND MARKINGS

Application

5.2.12.1 Recommendation.— Aircraft stand markings should be provided for designated parking positions on a paved apron.

Location

5.2.12.2 Recommendation.— Aircraft stand markings should be located so as to provide the clearances specified in 3.6.5.1 when the nose wheel follows the stand marking.

Characteristics

5.2.12.3 Recommendation.— Aircraft stand markings should include such elements as stand identification, lead–in line, turn bar, turning line, alignment bar, stop line and lead–out line, as are required by the parking configuration and to complement other parking aids.

5.2.12.4 Recommendation.— An aircraft stand identification marking (letter and/or number) should be included in the lead–in line a short distance after the beginning of the lead–in line. The height of the identification should be adequate to be readable from the cockpit of aircraft using the stand.

5.2.12.5 Recommendation.— Where two sets of aircraft stand markings are superimposed on each other in order to permit more flexible use of the apron and it is difficult to identify which stand marking should be followed, or safety would be impaired if the wrong marking was followed, then identification of the aircraft for which each set of markings is intended should be added to the stand identification.

Note. — Example: 2A – B747, 2B – F28

5.2.12.6 Recommendation.— Lead-in, turning and lead-out lines should normally be continuous in length and have a width of not less than 15 cm. Where one or more sets of stand markings are superimposed on a stand marking, the lines should be continuous for the most demanding aircraft and broken for other aircraft.

5.2.12.7 Recommendation.— The curved portions of lead-in, turning and lead-out lines should have radii appropriate to the most demanding aircraft type for which the markings are intended.

5.2.12.8 Recommendation.— Where it is intended that an aircraft proceed in one direction only, arrows pointing in the direction to be followed should be added as part of the lead-in and lead-out lines.

5.2.12.9 Recommendation.— A turn bar should be located at right angles to the lead-in line, abeam the left pilot position at the point of initiation of any intended turn. It should have a length and width of not less than 6 m and 15 cm, respectively, and include an arrowhead to indicate the direction of turn.

Note.— *The distances to be maintained between the turn bar and the lead-in line may vary according to different aircraft types, taking into account the pilot's field of view.*

5.2.12.10 Recommendation.— If more than one turn bar and/or stop line is required, they should be coded.

5.2.12.11 Recommendation.— An alignment bar should be placed so as to be coincident with the extended centre line of the aircraft in the specified parking position and visible to the pilot during the final part of the parking manoeuvre. It should have a width of not less than

15 cm.

5.2.12.12 Recommendation.— A stop line should be located at right angles to the alignment bar, abeam the left pilot position at the intended point of stop. It should have a length and width of not less than 6 m and 15 cm, respectively.

Note.— *The distances to be maintained between the stop line and the lead-in line may vary according to different aircraft types, taking into account the pilot's field of view.*

5.2.13 APRON SAFETY LINES

Application

5.2.13.1 Recommendation.— Apron safety lines should be provided on a paved apron as required by the parking configurations and ground facilities.

Location

5.2.13.2 Standard.— Apron safety lines shall be located so as to define the areas intended for use by ground vehicles and other aircraft servicing equipment, etc., to provide safe separation from aircraft.

Characteristics

5.2.13.3 Recommendation.— Apron safety lines should include such elements as wing tip clearance lines and service road boundary lines as required by the parking configurations and ground facilities.

5.2.13.4 Recommendation.— An apron safety line should be continuous in length and at least 10 cm in width.

5.2.13.5 Standard.— An apron safety line shall not be coloured red where an aircraft will cross the line (eg. vehicle corridors).

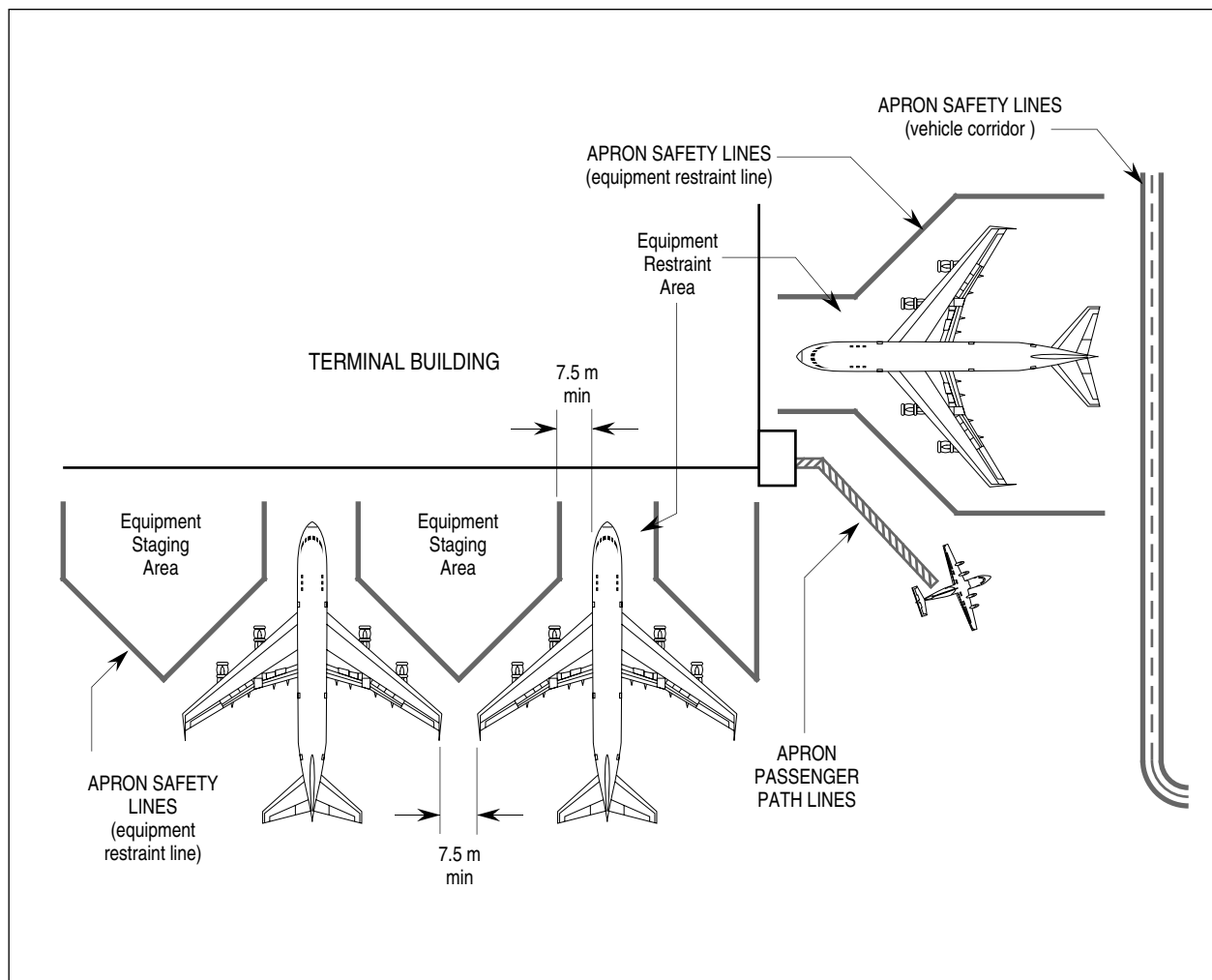

Figure 5-7. Examples of apron safety lines and passenger path lines

5.2.14 APRON PASSENGER PATH LINES

Application

5.2.14.1 Recommendation.— Where passengers are required to walk on an apron between the aircraft stand and the passenger terminal, apron passenger path line markings should be provided.

Location

5.2.14.2 Recommendation.— The apron passenger path line markings should be located such that they provide continuous guidance from the edge of the apron to the entry door position of the aircraft for which the aircraft stand is normally intended to serve.

Characteristics

5.2.14.3 Recommendation.— Apron passenger path line markings should not cross aircraft stand markings, aircraft stand taxilane markings, or taxiway markings.

5.2.14.4 Recommendation.— Apron passenger path line markings should consist of two parallel lines with diagonal hatching between them giving a zebra stripe appearance.

Note.— It has been found acceptable to paint parallel lines spaced approximately 2 m apart with hatching at 45° angle to the parallel lines. The hatching is spaced at 1 m intervals. The individual lines are 150 mm wide.

5.2.15 ROAD-HOLDING POSITION MARKING

Application

5.2.15.1 Standard.— A road-holding position marking shall be provided at all paved road entrances to a runway.

5.2.15.2 Recommendation.— A road-holding position marking should be provided, as far as practicable, at all unpaved road entrances to a runway.

Location

5.2.15.3 Standard.— The road-holding position marking shall be located across the road at the holding position.

Characteristics

5.2.15.4 Standard.— The road-holding position marking shall be in accordance with the local traffic regulations.

5.2.16 INFORMATION MARKING

Application

5.2.16.1 Recommendation.— Where it is impracticable to install an information sign, the information should be conveyed through an information marking.

5.2.16.2 Recommendation.— Where operationally required an information sign should be supplemented by an information marking.

Location

5.2.16.3 Recommendation.— The information marking should be displayed across the surface of the taxiway or apron where necessary and positioned so as to be legible from the cockpit of an approaching aircraft.

Characteristics

5.2.16.4 Standard.— The marking shall be yellow.

5.2.16.5 Recommendation.— The character height should be 4 m. The inscriptions should be in the form and proportions shown in Figure 5-8.

Note.— *It has been found that, on surfaces of light colour, the conspicuity of the marking can be improved by outlining it in black.*

5.2.16.6 Recommendation.— When combinations of letters and numerals are arrayed vertically or when the information marking interrupts an aircraft stand marking, aircraft stand taxilane marking, or taxiway centre line marking, a space of 1 m should be allowed between characters or between the character and aircraft stand marking, aircraft stand taxilane marking, or taxiway centre line marking.

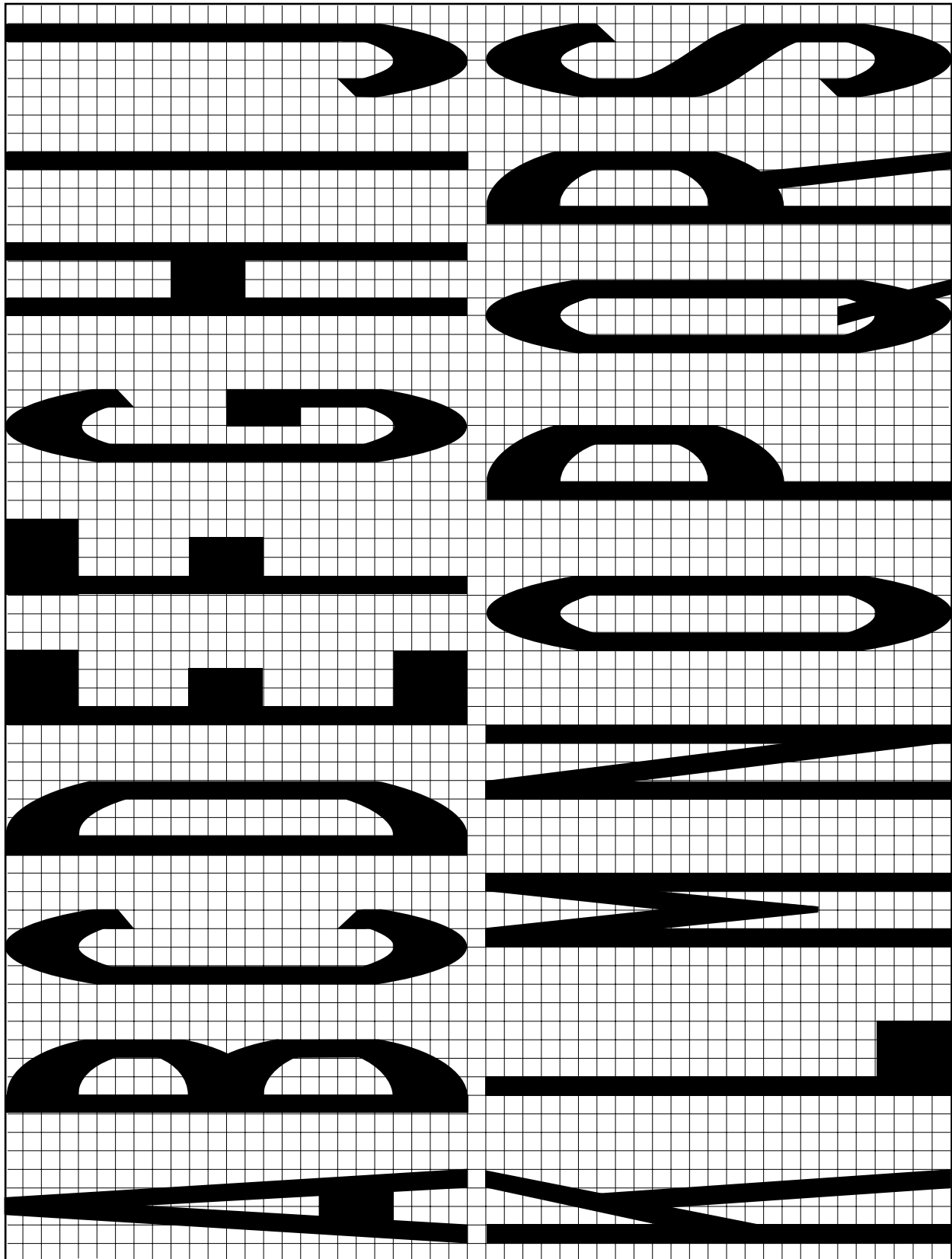

Figure 5-8. Form and Proportion of Information markings (sheet 1)

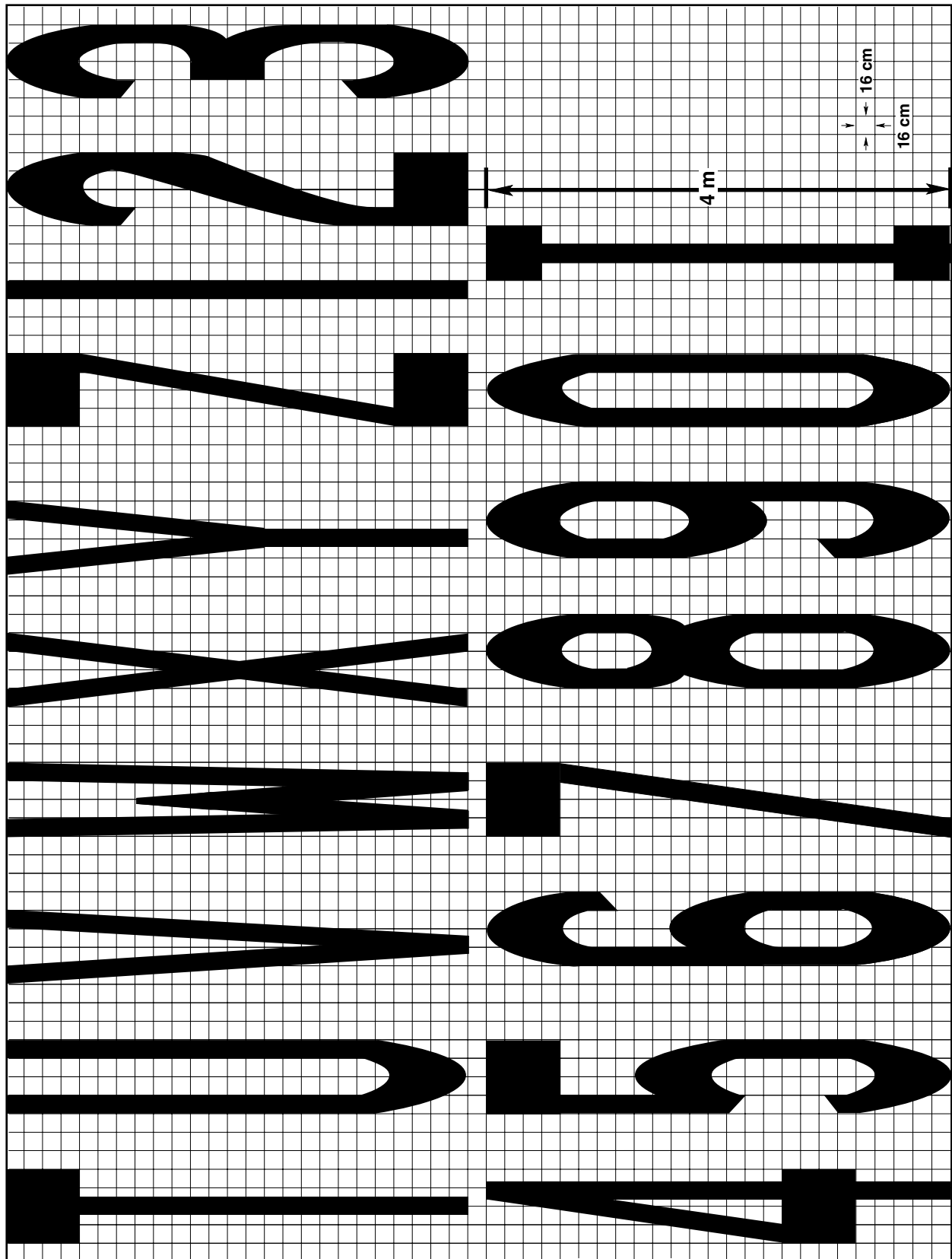

Figure 5-8. Form and Proportion of Information Markings (Sheet 2)

5.3 LIGHTS

5.3.1 GENERAL

Lights which may endanger the safety of aircraft

5.3.1.1 Standard.— A non-aeronautical ground light near an aerodrome which might endanger the safety of aircraft shall be extinguished, screened or otherwise modified so as to eliminate the source of danger.

Lights which may cause confusion

5.3.1.2 Recommendation.— A non-aeronautical ground light which, by reason of its intensity, configuration or colour, might prevent, or cause confusion in, the clear interpretation of aeronautical ground lights should be extinguished, screened or otherwise modified so as to eliminate such a possibility. In particular, attention should be directed to a non-aeronautical ground light visible from the air within the approach area.

Aeronautical ground lights which may cause confusion to mariners

Note.— In the case of aeronautical ground lights near navigable waters, consideration needs to be given to ensuring that the lights do not cause confusion to mariners.

LIGHT FIXTURES AND SUPPORTING STRUCTURES

Note.— See 8.6 for information regarding siting and construction of equipment and installations on operational areas, and the ICAO Aerodrome Design Manual, Part 4 for guidance on frangibility of light fixtures and supporting structures.

Elevated approach lights

5.3.1.3 Standard.— Elevated approach lights and their supporting structures within 300 m from the threshold (but not including the 300 m crossbar), or up to a distance from the runway end where the approach lights no longer constitute the major hazard to an aircraft overrunning the runway end to an airborne aircraft inadvertently striking them, whichever distance is less, shall be

frangible.

5.3.1.4 Recommendation.— To the extent that it is practicable all other elevated approach lights and supporting structures as far as they constitute the critical hazard beyond the point defined in 5.3.1.3 should be frangible. In cases where it is not practicable to make such other elevated approach lights and supporting structures frangible, these characteristics should relate to at least the top 1.8 m of the structure.

Note.— Consideration may be given to mounting the approach lights on supports that will keep the fixtures above the snow level and, for fixtures outside the aerodrome boundary, at a height that will preclude the interference from, or hazard to, livestock, etc.

5.3.1.5 Standard.— An elevated approach light fixture shall not penetrate an obstacle limitation surface.

5.3.1.6 Standard.— When an approach light fixture or supporting structure is not in itself sufficiently conspicuous, it shall be suitably marked in accordance with Standards Obstruction Markings, TP 382.

Elevated lights

5.3.1.7 Standard.— Elevated runway, stopway and taxiway lights shall be frangible. Their height shall be sufficiently low to preserve clearance for propellers and for the engine pods of jet aircraft.

Surface lights

5.3.1.8 Standard.— Light fixtures inset in the surface of runways, stopways, taxiways and aprons shall be so designed and fitted as to withstand being run over by the wheels of an aircraft without damage either to the aircraft or to the lights themselves.

5.3.1.9 Recommendation.— The temperature produced by conduction or radiation at the interface between an installed inset light and an aircraft tire should not exceed 160°C during a 10 minute period of exposure.

Note.— Guidance on measuring the temperature of inset lights is given in the ICAO Aerodrome Design Manual, Part 4.

LIGHT INTENSITY AND CONTROL

Note.— In dusk or poor visibility conditions by day, lighting can be more effective than marking. For lights to be effective in such conditions or in poor visibility by night, they must be of adequate intensity. To obtain the required intensity, it will usually be necessary to make the light directional, in which case the arcs over which the light shows will have to be adequate and so orientated as to meet the operational requirements. The runway lighting system will have to be considered as a whole, to ensure that the relative light intensities are suitably matched to the same end.

5.3.1.10 Standard.— The intensity of runway lighting shall be adequate for the minimum conditions of visibility and ambient light in which use of the runway is intended, and compatible with that of the nearest section of the approach lighting system when provided.

Note.— While the lights of an approach lighting system may be of higher intensity than the runway lighting, it is good practice to avoid abrupt changes in intensity as these could give a pilot a false impression that the visibility is changing during approach.

Table 5-2. Aerodrome light intensity settings

Lighting system	Number of required intensity settings	Intensity setting (%: percentage of required output or cd: effective candelas)				
		(1)	(2)	(3)	(4)	(5)
HIGH INTENSITY LIGHTING SYSTEMS:						
Precision approach CAT II & III (ALSF-2):						
- steady burning lamps	5	0.2%	1%	5%	25%	100%
- capacitor discharge lights	5	450 cd	450 cd	2000 cd	2000 cd	20000 cd
Precision approach CAT I (SSALR):						
- steady burning lamps	5	0.2%	1%	5%	25%	100%
- capacitor discharge lights	5	450 cd	450 cd	2000 cd	2000 cd	20000 cd
Threshold and Wing bar lights	5	1%	5%	25%	100%	100%
Runway edge lights	5	0.2%	1%	5%	25%	100%
Runway end lights	5	0.2%	1%	5%	25%	100%
Runway centre line lights	5	0.2%	1%	5%	25%	100%
Taxiway centre line lights	5	0.2%	1%	5%	25%	100%
MEDIUM INTENSITY LIGHTING SYSTEMS						
Precision approach CAT I (MALSR):						
- steady burning lamps	3	4%	20%	100%		
- capacitor discharge lights	3	450cd	2000cd	20000cd		
Simple approach light system (ODALS)	3	300cd	1500cd	5000cd		
Threshold lights	3	10%	30%	100%		
Runway edge lights	3	10%	30%	100%		
Runway end lights	3	10%	30%	100%		

5.3.1.11 Standard.— Where a medium or high-intensity lighting system is provided, a suitable intensity control shall be incorporated to allow for adjustment of the light intensity to meet the prevailing conditions. Separate intensity controls or other suitable methods shall be provided to ensure that the following systems when installed, can be operated at compatible intensities:

- approach lighting system;
- runway edge lights;
- runway threshold and wing bar lights;
- runway end lights;
- runway centre line lights;
- runway touchdown zone lights; and
- taxiway centre line lights.

5.3.1.12 Standard.— On the perimeter of and within the ellipse defining the main beam in Appendix B, Figures B-1 to B-11, the maximum light intensity value shall not be greater than three times the minimum light intensity value measured in accordance with Appendix B, section B.1.12.

5.3.1.13 Standard.— On the perimeter of and within the rectangle defining the main beam in Appendix B, Figures B-13 to B-17, the maximum light intensity value shall not be greater than three times the minimum light intensity value measured in accordance with Appendix B, section B.2.7.

5.3.2 EMERGENCY LIGHTING

Application

5.3.2.1 Recommendation.— At an aerodrome provided with runway lighting and without a secondary power supply, sufficient emergency lights should be conveniently available for installation on at least the primary runway in the event of failure of the normal lighting system.

Note.— *Emergency lighting may also be useful to mark obstacles or delineate taxiways and apron areas.*

Location

5.3.2.2 Recommendation.— When installed on a runway the emergency lights should, as a minimum, conform to the configuration required for a non-instrument runway.

Characteristics

5.3.2.3 Recommendation.— The colour of the emergency lights should conform to the colour requirements for runway lighting, except that, where the provision of coloured lights at the threshold and the runway end is not practicable, all lights may be variable white or as close to variable white as practicable.

5.3.3 AERODROME BEACON

Application

5.3.3.1 Standard.— An aerodrome beacon shall be provided at each aerodrome intended for use at night, except when, in special circumstances, the beacon is considered by the Certifying Authority as unnecessary upon determination that it is not required by one or more of the following conditions:

- a) the aerodrome is located on or near a frequently used night VFR route.
- b) the aerodrome is frequently used by aircraft navigating visually during periods of reduced visibility.
- c) it is difficult to locate the aerodrome from the air due to surrounding lights or terrain.

Location

5.3.3.2 Standard.— The aerodrome beacon shall be located on or adjacent to the aerodrome in an area of low ambient background lighting.

5.3.3.3 Recommendation.— The location of the beacon should be such that the beacon is not shielded by objects in significant directions and does not dazzle a pilot approaching to land.

Note.— *Care is required to ensure that any electrical disturbance generated from the switching technique of the beacon light does not cause any radio interference.*

Characteristics

5.3.3.4 Standard.— The aerodrome beacon shall show white flashes. The frequency

of total flashes shall be from 20 to 30 per minute.

5.3.3.5 Standard.— The light from the beacon shall show at all angles of azimuth. The vertical light distribution shall extend upwards from an elevation of not more than 1°. The effective intensity of the flash in white shall not be less than 2000 cd.

Note 1.— *Aerodrome beacon may be of two types, the rotating beacon or flashing capacitor discharge light.*

Note 2.— *At locations where a high ambient background lighting level cannot be avoided, the effective intensity of the flash may be required to be increased by a factor up to a value of 10*

5.3.4 NOT ALLOCATED

5.3.5 APPROACH LIGHTING SYSTEM

Note.— *It is intended that existing approach lighting systems not conforming to the specifications in 5.3.5 be replaced not later than January 1, 2005. Consequently, and taking into account the average service life of approach lighting systems, airport operators are encouraged to install only systems conforming to the specifications contained in 5.3.5.1 to 5.3.5.47 inclusive. Specifications for non-conforming approach light systems are contained in the previous edition (3rd) of TP 312.*

Application

5.3.5.1

Non-instrument runway

Recommendation.— A simple Approach Lighting System as specified in 5.3.5.2 to 5.3.5.13 should be provided to serve a non-instrument runway where circling guidance is necessary or where the code number is 3 or 4 and intended for use at night, except when the runway is used only in conditions of good visibility, and sufficient guidance is provided by other visual aids.

Note.— *A simple Approach Light System can also provide visual guidance by day.*

Non precision approach runway

Recommendation.— A simple Approach Lighting System as specified in 5.3.5.2 to 5.3.5.13 should be provided to serve a non-precision approach runway, except when the runway is used only in conditions of good visibility or sufficient guidance is provided by other visual aids.

Note.— *It may be advisable to give consideration to the installation of a precision approach category I lighting system.*

Precision approach runway category I

Standard.— Where physically practicable, a precision approach category I lighting system as specified in 5.3.5.14 to 5.3.5.26 shall be provided to serve a precision approach runway category I.

Precision approach runway category II and III

Standard.— Precision approach runway category II and III lighting systems as specified in 5.3.5.27 to 5.3.5.48 shall be provided to serve a precision approach runway category II or III.

SIMPLE APPROACH LIGHTING SYSTEM

Note.— The simple approach lighting system is referred to by the acronym ODALS.

Description

5.3.5.2 Standard.— A simple approach lighting system shall consist of a minimum of 5 lights installed on the extended centre line of the runway extending over a distance of 450 m and two light units, one each abeam the runway threshold as shown in Figure 5–9.

Location

5.3.5.3 Standard.— The lights forming the centre line shall be placed at longitudinal intervals of 90 m. The innermost light shall be located 90 m from the threshold.

5.3.5.4 Standard.— The two lights installed abeam the runway threshold shall be placed at a lateral distance of 12 m from the runway edge and a longitudinal distance not greater than 30 m from the runway threshold.

5.3.5.5 Recommendation.— The two lights installed abeam the runway threshold should be installed in line with the runway threshold lights.

Note.— A range up to 30 m from the threshold has been specified to allow for environmental and operational factors.

5.3.5.6 Standard.— The system shall lie as nearly as practicable in the horizontal plane passing through the threshold, provided that:

- a) no light shall be screened from an approaching aircraft; and
- b) as far as possible, no object shall protrude through the plane of lights within a distance of 60 m from the centre line of the system. Where this is unavoidable, as in the case of a single isolated object protruding through the plane of lights the object shall be treated as an obstacle and marked and lighted accordingly.

5.3.5.7 Standard.— Where it is necessary, due to terrain features or to minimize the height of supporting structures, to install the light centres in a sloping plane, the maximum slope shall not exceed +2° or -2°.

5.3.5.8 Standard.— The lights forming the centre line shall have a longitudinal installation tolerance of not more than ± 7.5 m and a lateral installation tolerance of ± 1 m from the runway centre line.

5.3.5.9 Standard.— The two runway threshold light units shall be installed within a vertical tolerance of + 0.5 m to – 0.5 m from the crown of the runway end elevation

Characteristics

5.3.5.10 Standard.— The lights of a simple approach lighting system shall consist of single omni-directional variable white flashing capacitor discharge light units.

5.3.5.11 Standard.— Each capacitor discharge light shall be flashed in sequence, beginning with the outermost light and progressing toward the threshold to the innermost light of the system. The centre line lights shall be sequenced 1 through 5 with 1/15 second interval between flashes. The 2 runway threshold units shall flash simultaneously 4/15 seconds after the innermost centre line light. The cycle begins again 7/15 secs after the flash of the two runway threshold lights giving an overall rate of 60 cycles per minute $\pm 10\%$.

5.3.5.12 Standard.— The intensity of the white lights shall be in accordance with the specifications of Table 5–2.

5.3.5.13 Recommendation.— The lights should show at all angles of azimuth above 2° and be visible from any direction. Shielding of lights to reduce the dazzling effect in specific directions is permitted except that shielding of the lights is not permitted in the straight in approach area.

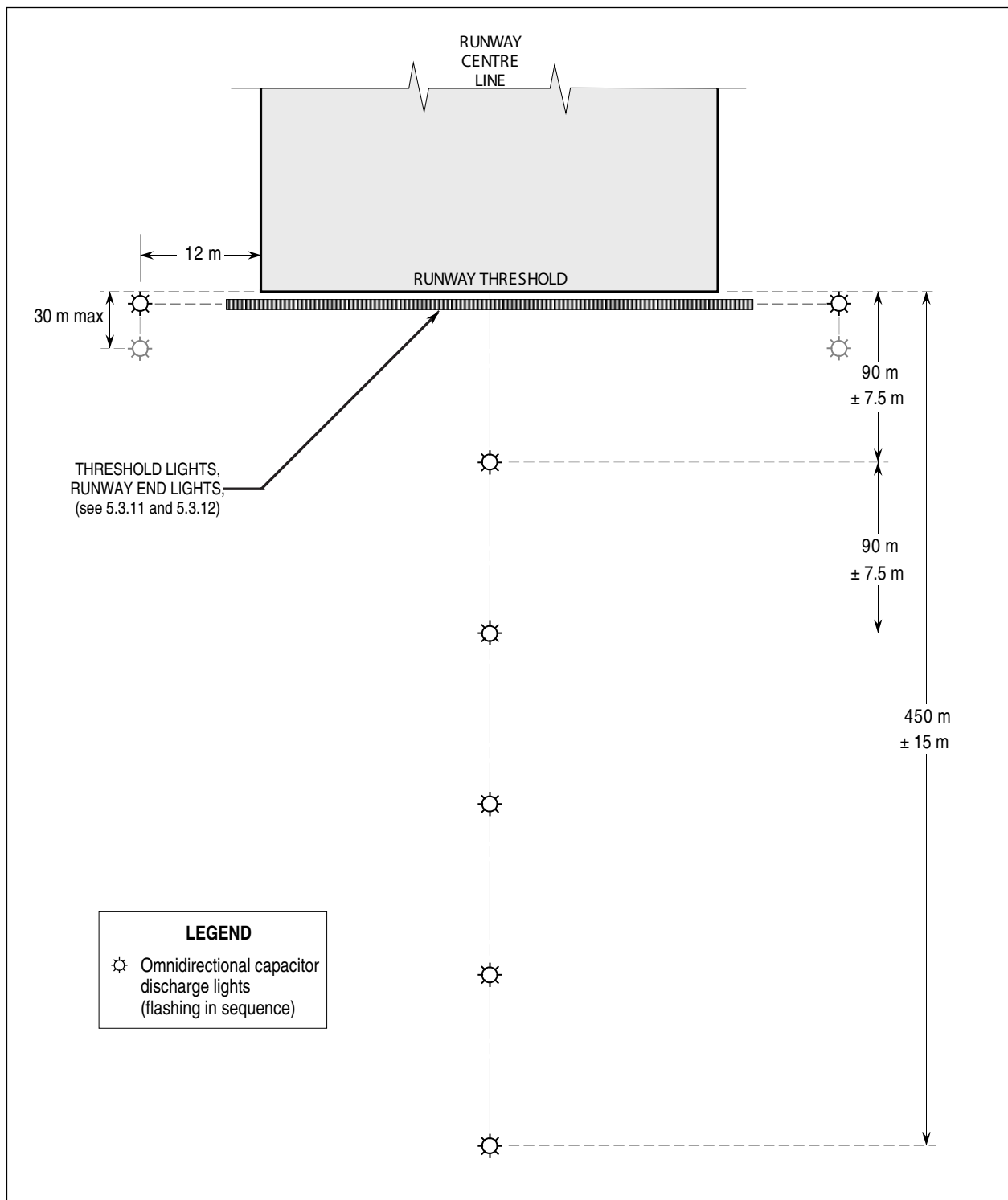

Figure 5-9. Simple approach lighting system (ODALS)

PRECISION APPROACH CATEGORY I LIGHTING SYSTEM

Note 1.— The precision approach category I lighting system is referred to by the acronym MALSR where medium intensity light fixtures are installed and SSALR where high intensity light fixtures are installed.

Note 2.— The intended application for SSALR is to allow operation of a precision approach category II & III lighting system in the configuration of a category I system during meteorological conditions that are at or above category I operating minimums (see 5.3.5.47 and 5.3.5.48). Notwithstanding the foregoing, it may be useful to consider installing SSALR as a stand alone system when it is envisioned to later upgrade to a Category II & III system or when rehabilitating an existing high intensity approach light system.

Description and location

5.3.5.14 Standard.— A precision approach category I lighting system shall be installed on the extended centre line of the runway extending over a distance of 720 m as shown in Figure 5–10 and shall consist of:

- a) seven centre line barrettes, placed at longitudinal intervals of 60 m with the innermost barrette located 60 m from the threshold;
- b) a cross bar located at 300 m from the runway threshold in line with the centre line barrette. The cross bar contains two side barrettes centred 7.5 m from the extended runway centre line; and
- c) five sequenced flashing capacitor discharge lights placed at longitudinal intervals of 60 m with the innermost light located 60 m beyond the outermost centre line barrette (480 m from the threshold).

5.3.5.15 Standard.— The system light centres shall lie as nearly as practicable in the horizontal plane passing through the threshold, provided that:

- a) no lights shall be screened from an approaching aircraft; and

- b) as far as possible, no object shall protrude through the plane of the approach lights within a distance of 60 m from the centre line of the system. Where this is unavoidable, as in the case of a single isolated object protruding through the plane of the lights, the object shall be treated as an obstacle and marked and lighted accordingly .

5.3.5.16 Standard.— Any transportation corridor passing through the approach light area shall be considered as an object. As a minimum, 4.3 m shall be allowed above the crown of a road and for a railway, 6 m above the top of the rails. The height to be allowed above a waterway, river, canal, etc. shall be established by Aeronautical Study.

5.3.5.17 Standard.— Where it is necessary for the system to deviate from the horizontal plane due to terrain features, to minimize the height of supporting structures, or to achieve clearance over an object, sloping segments shall be permitted provided that:

- a) the slope starts not less than 90 m outwards from the runway threshold;
- b) only one rising gradient segment is permitted;
- c) only three changes in profile gradient are permitted;
- d) the slope gradient is kept to a minimum and does not exceed a rising gradient of 2%, nor a falling gradient of 1.0% to a point 420 m from the threshold, and from this point, the falling gradient shall not exceed 2.5%;
- e) the slope segment extends over a minimum of 3 light units and starts and ends at a light unit; and
- f) the sloping segment continues to the end of the approach light system, reverts to the horizontal, or begins a falling gradient provided that the final segment extends over a distance of three light units.

5.3.5.18 Standard.— The longitudinal tolerances for a precision approach category I lighting system shall not exceed those shown in Figure 5–10.

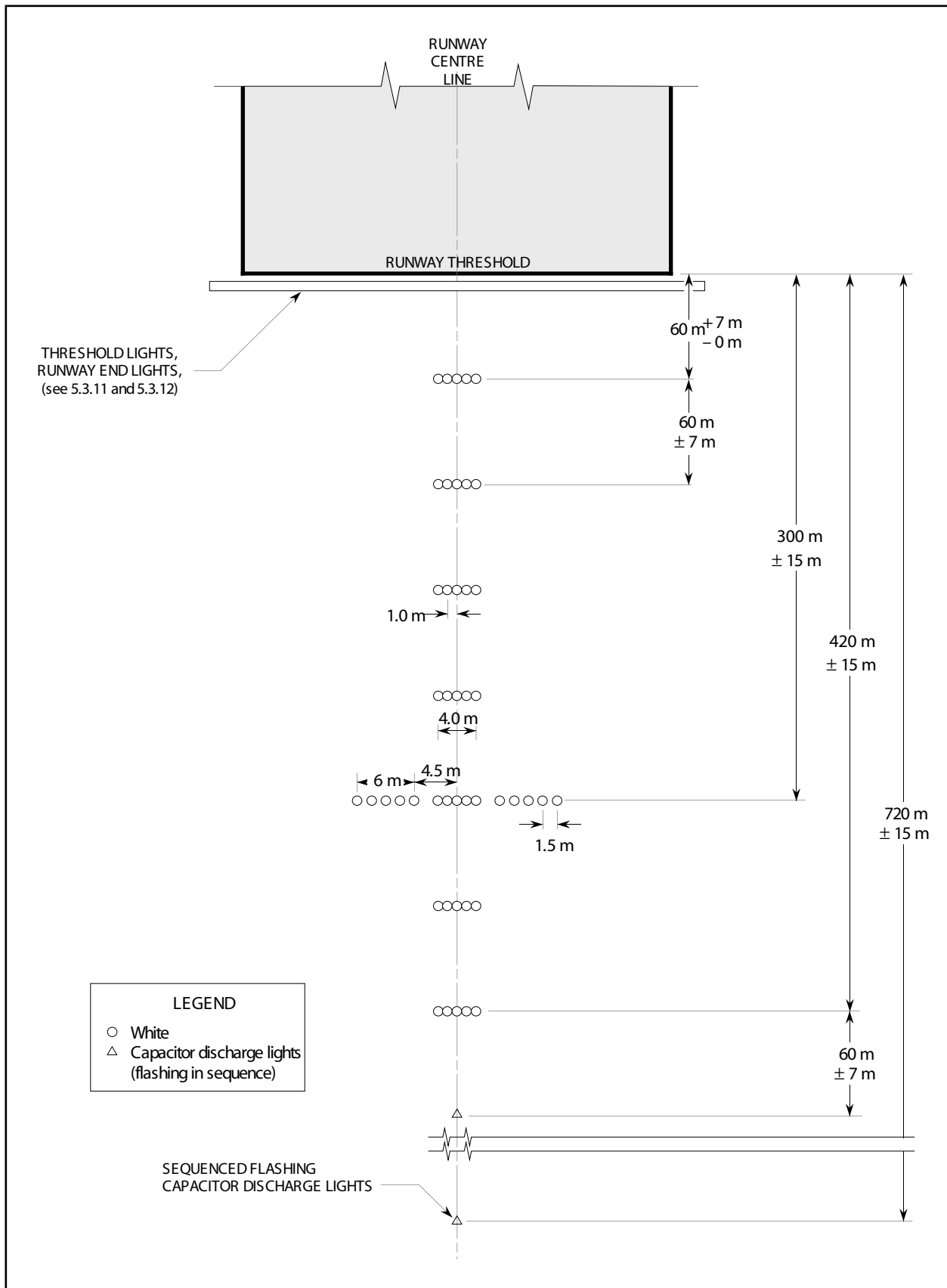

Figure 5-10. Precision Approach Category I lighting system

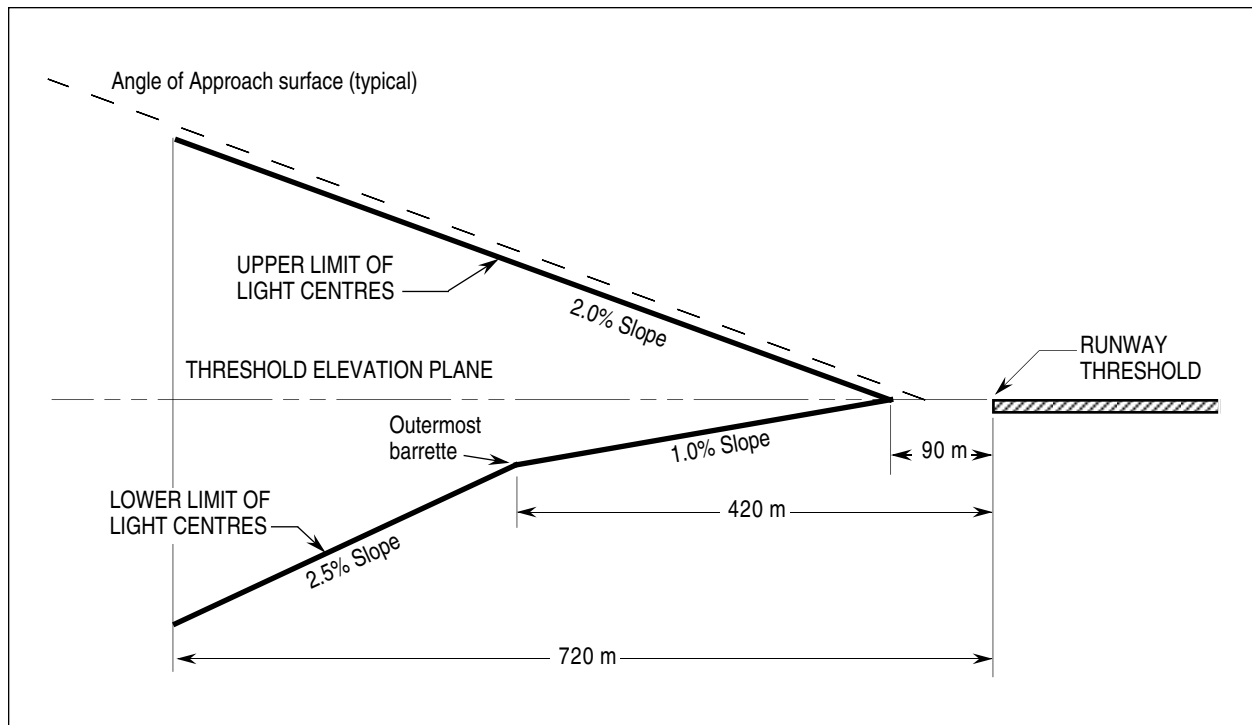

Figure 5-11. Vertical installation limits - Precision Approach Category I lighting system

5.3.5.19 Recommendation.— Where a barrette must be displaced longitudinally from its normal position, the adjacent barrettes should, where practicable, be displaced by appropriate amounts in order to maintain essentially equal spacing.

5.3.5.20 Standard.— The transverse tolerance for the installed position of an individual barrette centre shall be ± 15 cm.

Characteristics

5.3.5.21 Standard.— The centre line barrettes and crossbar lights of a precision approach category I lighting system as described in 5.3.5.14 a) and b) shall be fixed lights showing variable white. Each centre line barrette shall consist of 5 lights arranged 4 m in length. Each crossbar unit shall consist of a barrette 6 m in length containing 5 lights.

5.3.5.22 Standard.— Each light within a centre line barrette shall be spaced at $1.0 \text{ m} \pm 3.0$ cm. Each light within a cross bar barrette shall be spaced at $1.5 \text{ m} \pm 3.0$ cm. The vertical and lateral tolerance with respect to an individual light centre within a barrette shall be ± 3.0 cm.

5.3.5.23 Standard.— Each sequenced flashing capacitor discharge light described in 5.3.5.14 c) shall be flashed twice in a second with a time interval between flashes of adjacent units of 35 milli-seconds beginning with the outermost light and progressing toward the threshold to the innermost light of the system. The design of the triggering circuit shall be such that failure of one or more of the flash units does not effect operation of the remaining units. The design of the electrical circuit shall be such that the capacitor discharge lights can be operated independently of the other lights of the approach lighting system.

5.3.5.24 Standard.— The lights shall be in accordance with the specifications of Appendix B, section B.1.1.

5.3.5.25 Standard.— The lights shall be aligned laterally with their beam axis parallel to the extended runway centre line. The vertical alignment of lights shall be in accordance with Table 5-3 and Figure 5-14.

5.3.5.26 Standard.— The precision approach category I lighting system shall have a variable intensity control, either medium (3 intensity settings) or high (5 intensity settings) in accordance with the specifications of Table 5-2.

Table 5-3 Angle of elevation settings for Precision Approach Cat I lighting systems

Station	Vertical setting angle (degrees)			Station	Vertical setting angle (degrees)		
	Steady burning lamps		Flashing lamps		Steady burning lamps		Flashing lamps
	MALSR (PAR 38 lamps)	SSALR & MALSR (PAR 56 lamps)			MALSR (PAR 38 lamps)	SSALR & MALSR (PAR 56 lamps)	
60	3.2	6.2	----	420	3.7	7.0	----
120	3.3	6.3	----	480	----	----	6.0
180	3.4	6.5	----	540	----	----	6.0
240	3.4	6.6	----	600	----	----	6.0
300	3.5	6.7	----	660	----	----	6.0
360	3.6	6.9	----	720	----	----	6.0

Note.— These angle settings are for lights installed in a horizontal plane passing through the runway threshold. Figure 5-14 provides guidance on adjustments to the vertical alignment for lights that are not installed in the horizontal plane.

PRECISION APPROACH CATEGORY II AND III LIGHTING SYSTEM

Note.— The precision approach category II and III lighting system is referred to by the acronym ALSF-2.

Description and location

5.3.5.27 Standard.— A precision approach category II or III lighting system shall be installed on the extended centre line of the runway extending over a distance of 720 m as shown in Figure 5-12 and shall consist of:

- a) 24 centre line barrettes placed at longitudinal intervals of 30 m with the innermost barrette located 30 m from the threshold;
- b) 9 side row light barrettes placed on each side of, and aligned with the first 9 centre line barrettes described in (a). The lateral spacing (or gauge) between the innermost light of the side row shall be not less than 18 m nor more than 22.5 m, and preferably 18 m, but in any event shall be equal to that of the touchdown zone lighting.
- c) crossbars located 150 m and 300 m from the runway threshold; and
- d) 15 sequenced flashing capacitor discharge lights located on the extended runway centre line with each one mounted no greater than 1.5 m in front of a centre line barrette as described in (a), and with the innermost located with the barrette 300 m from the threshold.

5.3.5.28 Standard.— The cross bar barrettes provided at 150 m from the threshold shall be located equidistant between, and coincident with, the centre line barrettes and side row barrettes.

5.3.5.29 Standard.— The cross bar barrettes provided at 300 m shall extend on both sides of, and coincident with, the centre line barrette. They shall be positioned with their innermost lights centred 4.5 m from the extended runway centre line.

5.3.5.30 Standard.— The system light centres shall lie as nearly as practicable in the horizontal plane passing through the threshold, provided that:

- a) no lights shall be screened from an approaching aeroplane; and
- b) as far as possible, no object shall protrude through the plane of the approach lights within a distance of 60 m from the centre line of the system. Where this is unavoidable, as in the case of a single isolated object protruding through the plane of the lights, the object shall be treated as an obstacle and marked and lighted accordingly.

5.3.5.31 Standard.— Any transportation corridor passing through the approach light area shall be considered as an object. As a minimum, 4.3 m shall be allowed above the crown of a road and for a railway, 6 m above the top of the rails. The height to be allowed above a waterway, river, canal, etc. shall be established by Aeronautical Study.

5.3.5.32 Standard.— Where it is necessary for the system to deviate from the horizontal plane due to terrain features, to minimize the height of supporting structures, or to achieve clearance over an object, a sloping segment shall be permitted provided that:

- a) the slope starts not less than 90 m outwards from the runway threshold;
- b) only one sloping segment is permitted;
- c) the slope gradient is kept to a minimum and does not exceed a rising gradient of 2%, nor a falling gradient of 1% except that a falling gradient is not permitted in the inner 450 m;
- d) the slope segment extends over a minimum of 4 light units and starts and ends at a light unit; and
- e) the sloping segment may continue to the end of the approach light system or may revert to the horizontal provided that the horizontal segment extends over a distance of three light units.

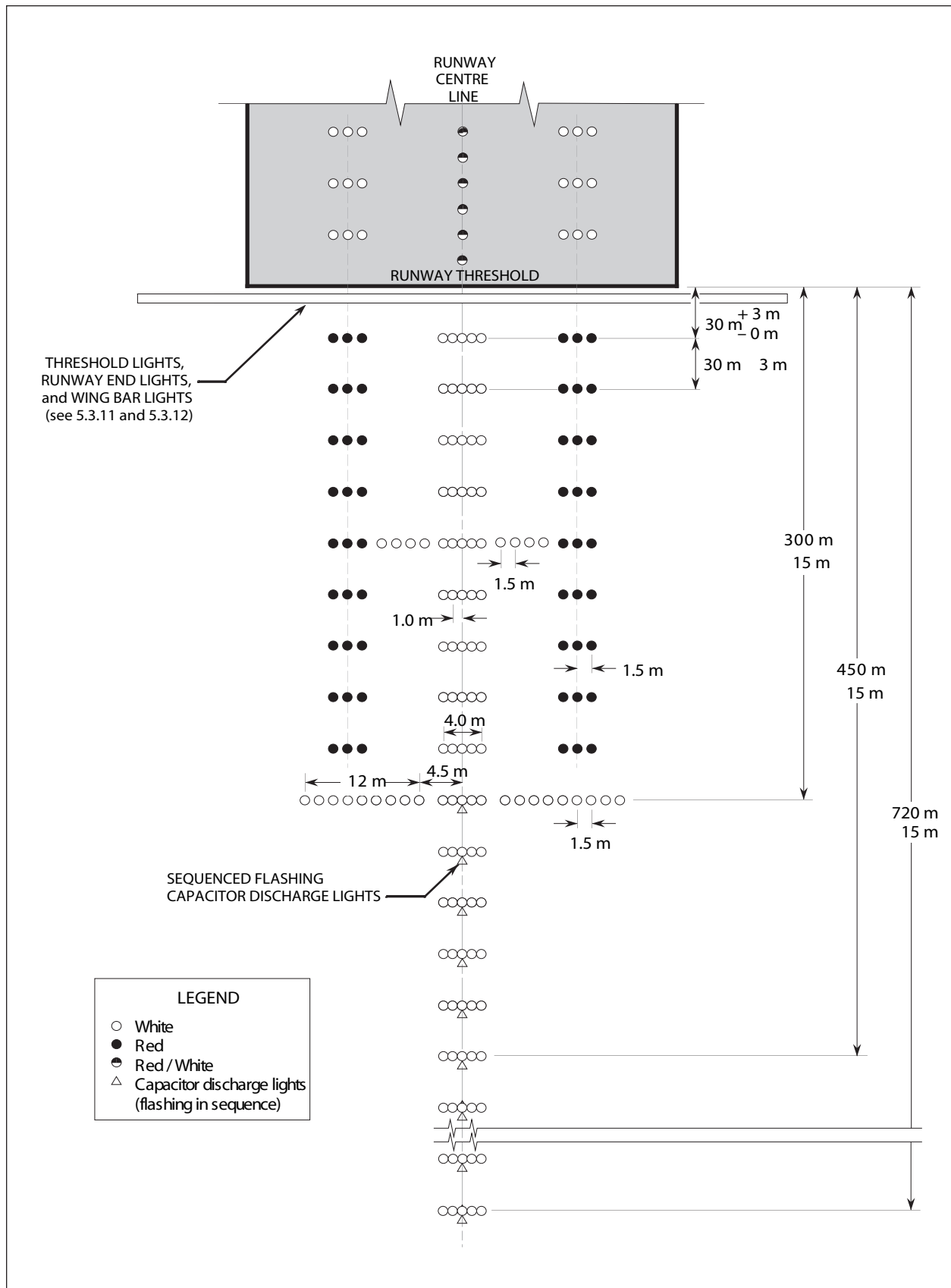

Figure 5-12. Precision Approach Category II and III lighting system

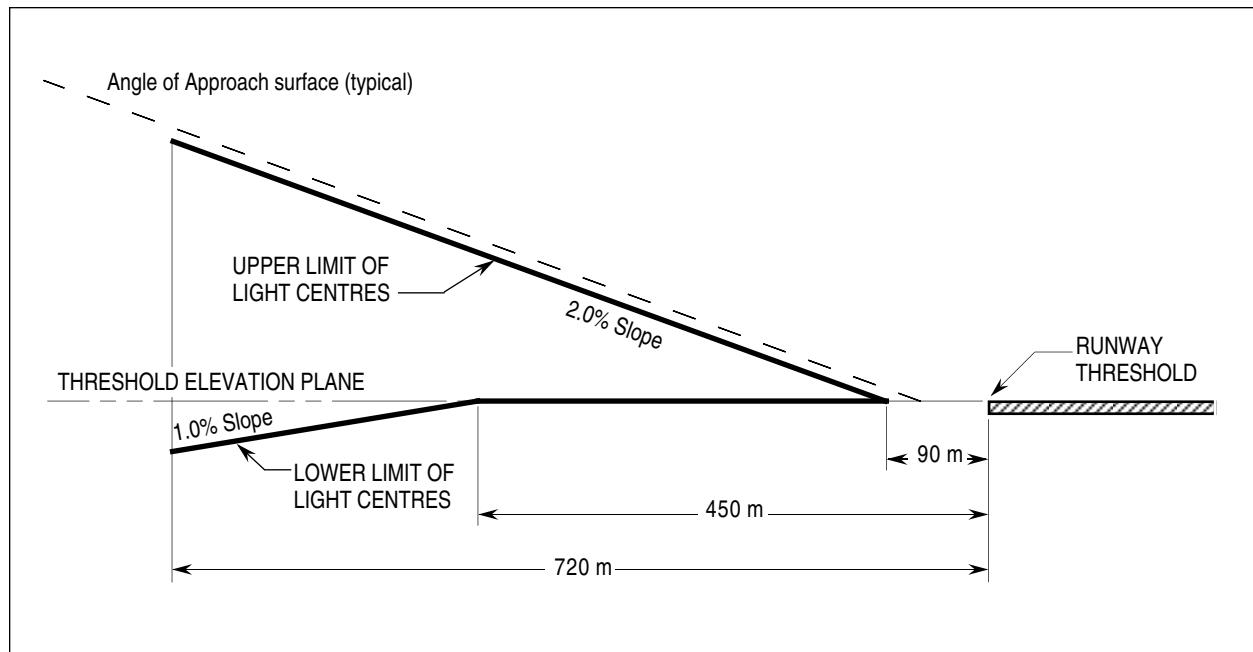

Figure 5-13. Vertical installation limits - Precision Approach Category II & III lighting system

5.3.5.33 Standard.— Each capacitor discharge light shall be mounted with the beam centre no higher than the beam centres of the steady burning lights of the associated centre line barrette, and not lower than 1.2 m below the plane established by the beam centres of the steady burning lights.

5.3.5.34 Standard.— The longitudinal tolerances for a precision approach category II and III lighting system shall not exceed those shown in Figure 5-12.

5.3.5.35 Recommendation.— Where a barrette must be displaced longitudinally from its normal position, the adjacent barrettes should, where practicable, be displaced by appropriate amounts in order to maintain essentially equal spacing.

5.3.5.36 Standard.— The transverse tolerance for the installed position of an individual barrette centre shall be ± 8 cm.

Characteristics

5.3.5.37 Standard.— Each centre line barrette within a precision approach category II and III lighting system shall contain 5 lights with centres 1.0 m apart having an overall width of 4 m.

5.3.5.38 Standard.— Each side row barrette within a precision approach category II and III lighting system shall contain 3 lights with centres 1.5 m apart, having an overall width of 3 m.

5.3.5.39 Standard.— The cross bar barrettes located 150 m from the runway threshold shall each contain 4 lights with centres 1.5 m apart, having an overall width of 4.5 m.

5.3.5.40 Standard.— The cross bar located 300 m from the runway threshold shall consist of the centre line barrette and two side barrettes. Each side barrette shall contain 9 lights with centres 1.5 m apart having an overall width of 12 m.

5.3.5.41 Standard.— The vertical and lateral tolerance with respect to an individual light centre within a barrette shall be ± 3.0 cm.

5.3.5.42 Standard.— The centre line barrettes and cross bar lights of a precision approach category II and III lighting system as described in 5.3.5.27 a) and c) shall be fixed white lights showing variable white. The side row lights as described in 5.3.5.27 b) shall be fixed lights showing variable red.

5.3.5.43 Standard.— Each sequenced flashing capacitor discharge light described in 5.3.5.27 d) shall be flashed twice a second in sequence, beginning with the outermost light in the system progressing toward the threshold to the innermost light of the system. The design of the triggering circuit shall be such that failure of one or more of the flashed units does not affect operation of the remaining units. The design of the electrical circuit shall be such that these lights can be operated independently of the other lights of the approach lighting system.

5.3.5.44 Standard.— The lights shall be in accordance with the specifications of Appendix B, Sections B.1.1 and B.1.2.

5.3.5.45 Standard.— The lights shall be aligned laterally with their beam axis parallel to the extended runway centre line. The vertical alignment of lights shall be in accordance with Table 5-4 and Figure 5-14.

5.3.5.46 Standard.— The precision approach category II and III lighting system shall have a variable intensity control with 5 settings in accordance with the specifications of Table 5-2.

5.3.5.47 Recommendation.— The lighting circuit should be designed such that the lights specified for a precision approach category II or III lighting system which are in addition to those specified for a precision approach category I lighting system may be extinguished when the reported weather conditions are at or above precision approach category I landing minima.

5.3.5.48 Standard.— Where the control circuit permits the configuration change specified in 5.3.5.47, the resulting light configuration shall conform to the specifications contained in 5.3.5.14 to 5.3.5.26 for a precision approach category I lighting system.

Table 5-4. Angle of elevation settings for Precision Approach Category II and III lighting systems

Station	Vertical setting angle (degrees)		Station	Vertical setting angle (degrees)	
	Steady burning lamps (PAR 56)	Flashing lamps		Steady burning lamps (PAR 56)	Flashing lamps
30	6.2	----	390	6.9	6.0
60	6.2	----	420	7.0	6.0
90	6.3	----	450	7.0	6.0
120	6.3	----	480	7.1	6.0
150	6.4	----	510	7.2	6.0
180	6.5	----	540	7.2	6.0
210	6.5	----	570	7.3	6.0
240	6.6	----	600	7.4	6.0
270	6.7	----	630	7.4	6.0
300	6.7	6.0	660	7.5	6.0
330	6.8	6.0	690	7.6	6.0
360	6.9	6.0	720	7.6	6.0

Note.— These angle settings are for lights installed in a horizontal plane passing through the runway threshold. Figure 5-14 provides guidance on adjustments to the vertical alignment for lights that are not installed in the horizontal plane.

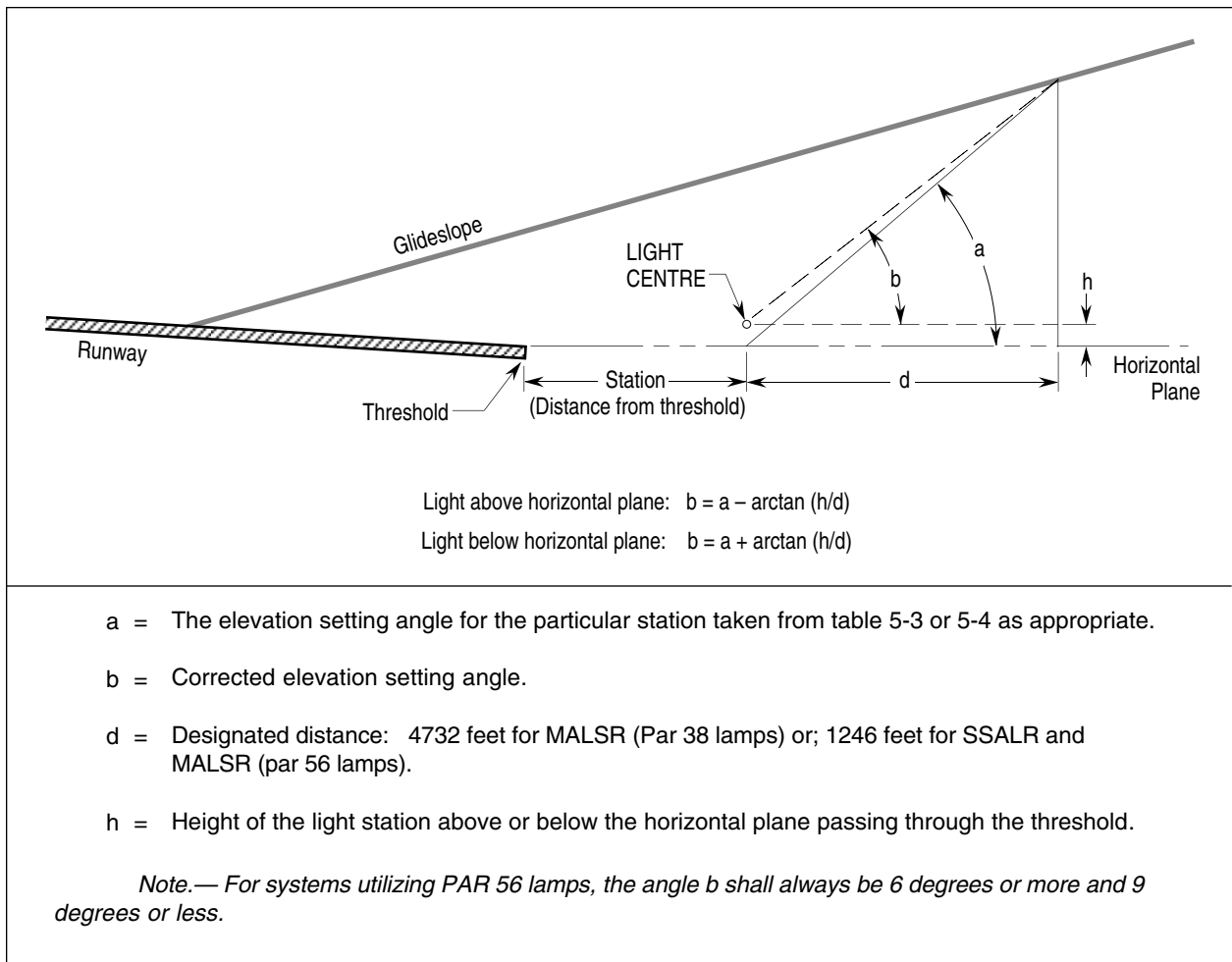

Figure 5-14. Correction of angle of elevation setting for Precision Approach Light stations displaced vertically from the horizontal plane

5.3.6 VISUAL APPROACH SLOPE INDICATOR SYSTEMS

Application

5.3.6.1 Standard.— A visual approach slope indicator system shall be provided to serve the approach to a runway where one or more of the following conditions exists:

- a) the runway is not served by an electronic glide path and the runway is used by turbojet or other aircraft with similar approach guidance requirements;
- b) the pilot of any type of aircraft may have difficulty in judging the approach due to:
 - i) inadequate visual guidance such as is experienced during an approach over water or featureless terrain by day or in the absence of sufficient extraneous lights in the approach area by night, or
 - ii) misleading information such as is produced by deceptive surrounding terrain or runway slopes;
- c) the presence of objects in the approach area may involve serious hazard if an aircraft descends below the normal approach path, particularly if there are no non-visual or other visual aids to give warning of such objects;
- d) physical conditions at either end of the runway present a serious hazard in the event of an aircraft under shooting or overrunning the runway; and
- e) terrain or prevalent meteorological conditions are such that the aircraft may be subjected to unusual turbulence during approach.

5.3.6.2 Recommendation.— A visual approach slope indicator system should be provided to serve the approach to a runway where the runway threshold is temporarily displaced from the normal position and the runway is served by turbojet aeroplanes.

5.3.6.3 Standard.— The standard visual approach slope indicator systems shall consist of PAPI and APAPI systems conforming to the specifications contained in 5.3.6.6 to 5.3.6.23 inclusive; as shown in Figures 5-15 and 5-16.

Note.— *It is intended that the specifications for PAPI and APAPI replace those for VASIS, AVASIS, 3-BAR VASIS and 3-BAR AVASIS, and that these latter four systems will cease to be standard visual approach slope indicator systems on 1 January 1995. Consequently, and taking into account the average service life of approach lighting systems, airport operators are encouraged to install only systems conforming to the specifications contained in 5.3.6.6 to 5.3.6.23 inclusive. Specifications for visual approach systems other than PAPI or APAPI are contained in TP 312, 3rd edition.*

5.3.6.4 Standard.— Visual approach slope indicator systems that do not conform to the specifications in 5.3.6 shall not be described by the abbreviations in 5.3.6.3.

5.3.6.5 Standard.— PAPI or APAPI shall be provided when one or more of the conditions specified in 5.3.6.1 exist in accordance with the following:

- a) PAPI shall be installed where the code number is 3 or 4.
- b) PAPI or APAPI shall be installed where the code number is 1 or 2.

Note.— *APAPI systems require regular inspection or monitoring to detect a misalignment which could lead to a dangerous approach path.*

PAPI and APAPI

Description

PAPI

5.3.6.6 Standard.— The PAPI system shall consist of a wing bar of 4 sharp transition multi-lamp (or paired single lamp) units equally spaced. The system shall be located on the left side of the runway unless it is physically impracticable to do so.

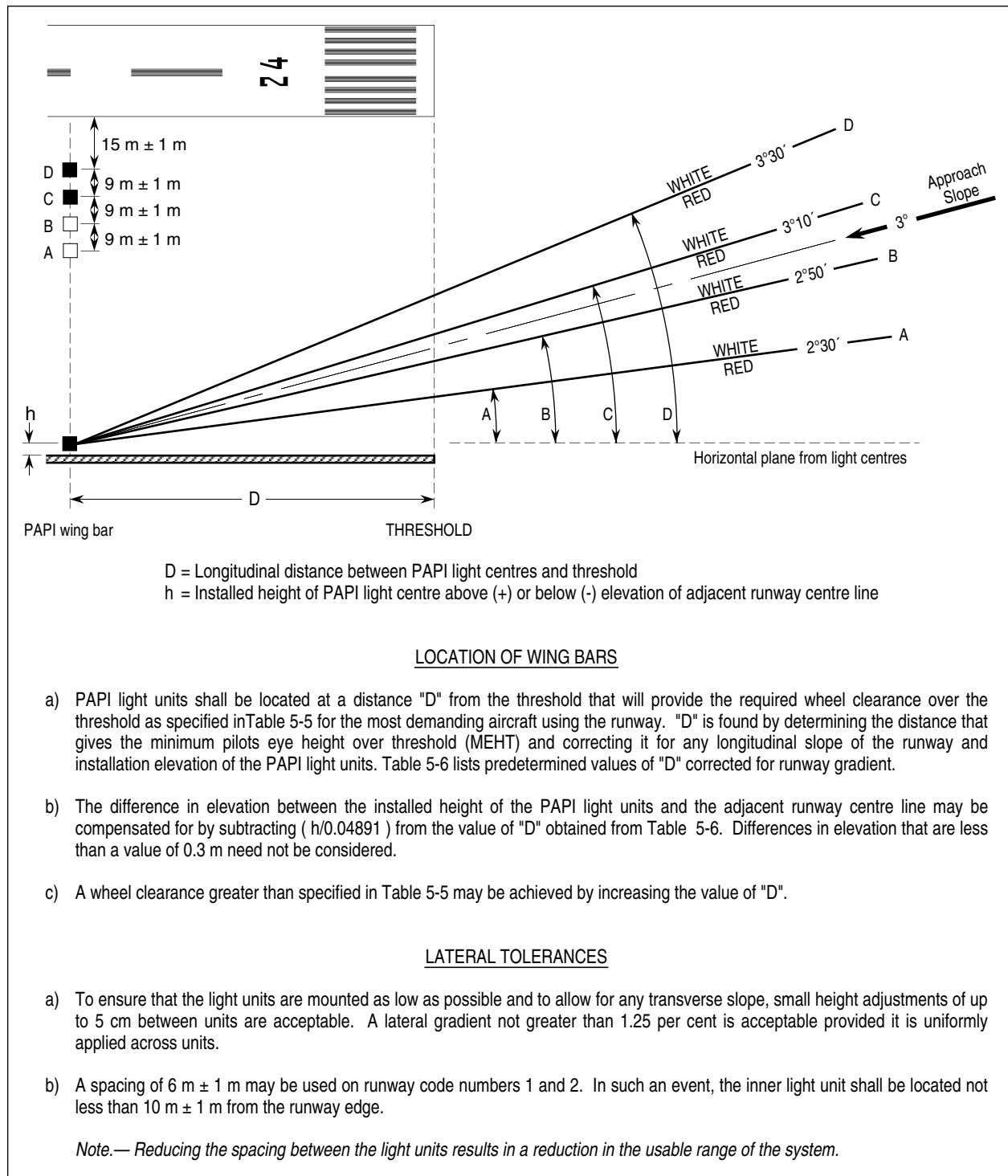

Figure 5-15. PAPI siting and angle of elevation settings

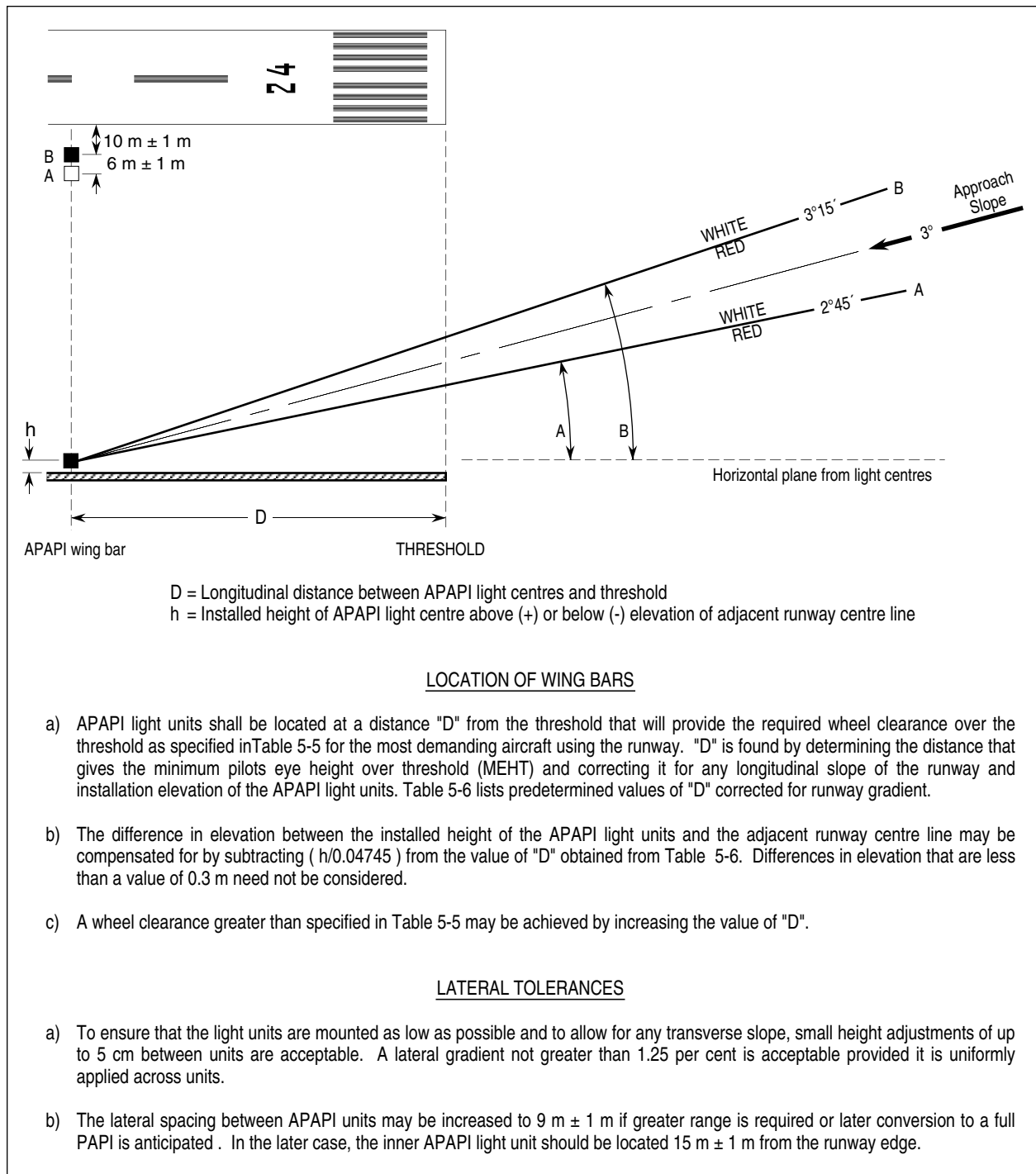

Figure 5-16. APAPI siting and angle of elevation settings

5.3.6.7 Standard.— The wing bar of a PAPI shall be constructed and arranged in such a manner that a pilot making an approach will:

- a) when on or close to the approach slope, see the two units nearest the runway as red and the two units farthest from the runway as white;
- b) when above the approach slope, see the one unit nearest the runway as red and the three units farthest from the runway as white; and when further above the approach slope, see all units, as white; and
- c) when below the approach slope, see the three units nearest the runway as red and the unit farthest from the runway as white; and when further below the approach slope, see all units as red.

APAPI

5.3.6.8 Standard.— The APAPI system shall consist of a wing bar of 2 sharp transition multi-lamp (or paired single lamp) units. The system shall be located on the left side of the runway unless it is physically impracticable to do so.

5.3.6.9 Standard.— The wing bar of an APAPI shall be constructed and arranged in such a

manner that a pilot marking an approach will:

- a) when on or close to the approach slope, see the unit nearer the runway as red and the unit farther from the runway as white;
- b) when above the approach slope, see both the units as white; and
- c) when below the approach slope, see both the units as red.

Location

5.3.6.10 Standard.— The light units shall be located as in the basic configuration illustrated in Figure 5-15 for PAPI and Figure 5-16 for APAPI, subject to the installation tolerances given therein. The units forming a wing bar shall be mounted so as to appear to the pilot of an approaching aircraft to be substantially in a horizontal line. The light units shall be mounted as low as possible and shall be sufficiently light and frangible not to constitute a hazard to aircraft.

5.3.6.11 Standard.— The light units shall be located so as to provide the minimum wheel clearance over the threshold specified in Table 5-5 for the most demanding aircraft using the runway.

Table 5-5. Wheel clearance over threshold for PAPI and APAPI

Eye-to-wheel height of aeroplane in the approach configuration ^a	Category	Desired wheel clearance (metres) ^{b,c}	Minimum wheel clearance (metres) ^d
(1)	(2)	(3)	(4)
up to but not including 3 m	AP & P1	6	3 ^e
3 m up to but not including 7.5 m	P2	9	4.5
7.5 m up to but not including 14 m	P3	9	6

- a. In selecting the eye-to-wheel height group, only aeroplanes meant to use the system on a regular basis shall be considered. The most demanding amongst such aeroplanes shall determine the eye-to-wheel height group.
- b. Where practicable the desired wheel clearances shown in column (3) shall be provided.
- c. the wheel clearances in column (3) may be reduced to no less than those in column (4) where an aeronautical study indicates that such reduced wheel clearances are acceptable.
- d. When a reduced wheel clearance is provided at a displaced threshold, it shall be ensured that the corresponding desired wheel clearance specified in column (3) will be available when an aeroplane at the top end of the eye-to-wheel height group chosen overflies the extremity of the runway.
- e. This wheel clearance may be reduced to 1.5 m on runways used mainly by light-weight non turbo-jet aeroplanes.

Table 5-6. Location of PAPI and APAPI wing bars from threshold

Runway gradient	Distance "D" to achieve minimum or desired wheel clearance over threshold (m)							
	APAPI		PAPI					
	AP EWH up to 3 m		P1 EWH up to 3 m		P2 EWH up to 7.5 m		P3 EWH up to 14.5 m	
(1)	(2)		(3)		(4)		(5)	
	minimum	desired	minimum	desired	minimum	desired	minimum	desired
2.0%	89.0	133.4	87.1	130.6	174.1	239.4	290.2	333.8
1.9%	90.3	135.4	88.4	132.5	176.7	243.0	294.5	338.7
1.8%	91.7	137.5	89.7	134.5	179.4	246.6	298.9	343.8
1.7%	93.1	139.6	91.0	136.6	182.1	250.3	303.5	349.0
1.6%	94.6	141.8	92.4	138.7	184.9	254.2	308.1	354.3
1.5%	96.1	144.1	93.9	140.8	187.8	258.2	312.9	359.9
1.4%	97.6	146.5	95.4	143.1	190.8	262.3	317.9	365.6
1.3%	99.3	148.9	96.9	145.4	193.8	266.5	323.1	371.5
1.2%	100.9	151.4	98.5	147.8	197.0	270.9	328.4	377.6
1.1%	102.7	154.0	100.2	150.2	200.3	275.4	333.8	383.9
1.0%	104.4	156.7	101.9	152.8	203.7	280.1	339.5	390.4
0.9%	106.3	159.4	103.6	155.4	207.2	284.9	345.4	397.2
0.8%	108.2	162.3	105.4	158.1	210.9	289.9	351.4	404.2
0.7%	110.2	165.3	107.3	161.0	214.6	295.1	357.7	411.4
0.6%	112.3	168.4	109.3	163.9	218.5	300.5	364.2	418.9
0.5%	114.4	171.6	111.3	167.0	222.6	306.1	371.0	426.7
0.4%	116.6	174.9	113.4	170.1	226.8	311.9	378.0	434.7
0.3%	118.9	178.4	115.6	173.4	231.2	317.9	385.3	443.1
0.2%	121.3	182.0	117.9	176.8	235.7	324.1	392.9	451.8
0.1%	123.8	185.8	120.2	180.3	240.4	330.6	400.7	460.8
0.0%	126.4	189.7	122.7	184.0	245.4	337.4	408.9	470.3
-0.1%	129.2	193.8	125.2	187.9	250.5	344.4	417.5	480.1
-0.2%	132.0	198.0	127.9	191.9	255.8	351.8	426.4	490.3
-0.3%	135.0	202.5	130.7	196.0	261.4	359.4	435.7	501.0
-0.4%	138.1	207.1	133.6	200.4	267.2	367.4	445.4	512.2
-0.5%	141.3	212.0	136.6	205.0	273.3	375.8	455.5	523.8
-0.6%	144.8	217.1	139.8	209.8	279.7	384.5	466.1	536.0
-0.7%	148.3	222.5	143.2	214.8	286.3	393.7	477.2	548.8
-0.8%	152.1	228.1	146.7	220.0	293.3	403.3	488.9	562.2
-0.9%	156.0	234.1	150.3	225.5	300.7	413.5	501.2	576.3
-1.0%	160.2	240.3	154.2	231.3	308.4	424.1	514.0	591.1
-1.1%	164.6	246.9	158.3	237.4	316.6	435.3	527.6	606.7
-1.2%	169.3	253.9	162.6	243.8	325.1	447.1	541.9	623.2
-1.3%	174.2	261.2	167.1	250.6	334.2	459.5	557.0	640.5
-1.4%	179.4	269.1	171.9	257.8	343.8	472.7	572.9	658.9
-1.5%	184.9	277.3	176.9	265.4	353.9	486.6	589.8	678.3
-1.6%	190.8	286.2	182.3	273.5	364.7	501.4	607.8	698.9
-1.7%	197.0	295.6	188.0	282.1	376.1	517.1	626.8	720.8
-1.8%	203.7	305.6	194.1	291.2	388.2	533.8	647.1	744.1
-1.9%	210.9	316.3	200.6	300.9	401.2	551.7	668.7	769.0
-2.0%	218.6	327.9	207.6	311.3	415.1	570.8	691.9	795.6

Characteristics of the light units

5.3.6.12 Standard.— The system shall be suitable for both day and night operations.

5.3.6.13 Standard.— The colour transition from red to white in the vertical plane shall be such as to appear to an observer, at a distance of not less than 300 m, to occur within a vertical angle of not more than 3 minutes of arc.

5.3.6.14 Standard.— The light intensity distribution of the light units shall be as shown in Appendix B, section B.3.1.

5.3.6.15 Recommendation.— Suitable intensity control should be provided so as to allow adjustment to meet the prevailing conditions and to avoid dazzling the pilot during approach and landing.

5.3.6.16 Standard.— Each light unit shall be capable of adjustment in elevation so that the lower limit of the white part of the beam may be fixed at any desired angle of elevation between 1°30' and at least 4°30' above the horizontal.

5.3.6.17 Standard.— The light units shall be so designed that deposits of condensation, snow, ice, dirt, etc., on optically transmitting or reflecting surfaces shall interfere to the least possible extent with the light signals and shall not affect the contrast between the red and white signals and the elevation of the transition sector.

Approach slope and elevation setting of light units

5.3.6.18 Standard.— The standard approach slope shall be 3.0 degrees.

5.3.6.19 Standard.— When the runway is equipped with an ILS, the siting and the angle of elevation of the light units shall be such that the visual approach slope conforms as closely as possible with the glide path of the ILS.

Note.— *Guidance on the harmonization of PAPI and ILS signals is contained in the ICAO Aerodrome Design Manual, Part 4.*

5.3.6.20 Standard.— The angle of elevation settings of the light units in a PAPI wing bar shall be as depicted in Figure 5-15 and such that, during an approach, the pilot of an aircraft

observing a signal of one white and three reds will clear all objects in the approach area by a safe margin.

5.3.6.21 Standard.— The angle of elevation settings of the light units in an APAPI wing bar shall be as depicted in Figure 5-16 and such that, during an approach, the pilot of an aircraft observing the lowest on slope signal, i.e. one white and one red, will clear all objects in the approach area by a safe margin.

Note.— *See 8.3.1 for provision of an automatic shut-off switch for unmonitored APAPI systems.*

5.3.6.22 Standard.— The azimuth spread of the light beam shall be suitably restricted where an object located outside the obstacle protection surface of the PAPI or APAPI system, but within the lateral limits of its light beam, is found to extend above the plane of the obstacle protection surface and an aeronautical study indicates that the object could adversely affect the safety of operations. The extent of the restriction shall be such that the object remains outside the confines of the light beam.

Note. — *See 5.3.6.24 to 5.3.6.28 concerning the related obstacle protection surface.*

OBSTACLE PROTECTION SURFACE

5.3.6.23 Standard.— An obstacle protection surface shall be established when it is intended to provide a visual approach slope indicator system.

5.3.6.24 Standard.— The characteristics of the obstacle protection surface, i.e. origin, divergence, length and slope shall correspond to those specified in the relevant column of Table 5-7 and in Figure 5-17.

5.3.6.25 Standard.— New objects or extensions of existing objects shall not be permitted above an obstacle protection surface except when, in the opinion of the certifying authority, the new object or extension would be shielded by an existing immovable object.

5.3.6.26 Standard.— Existing objects above an obstacle protection surface shall be removed except when, in the opinion of the

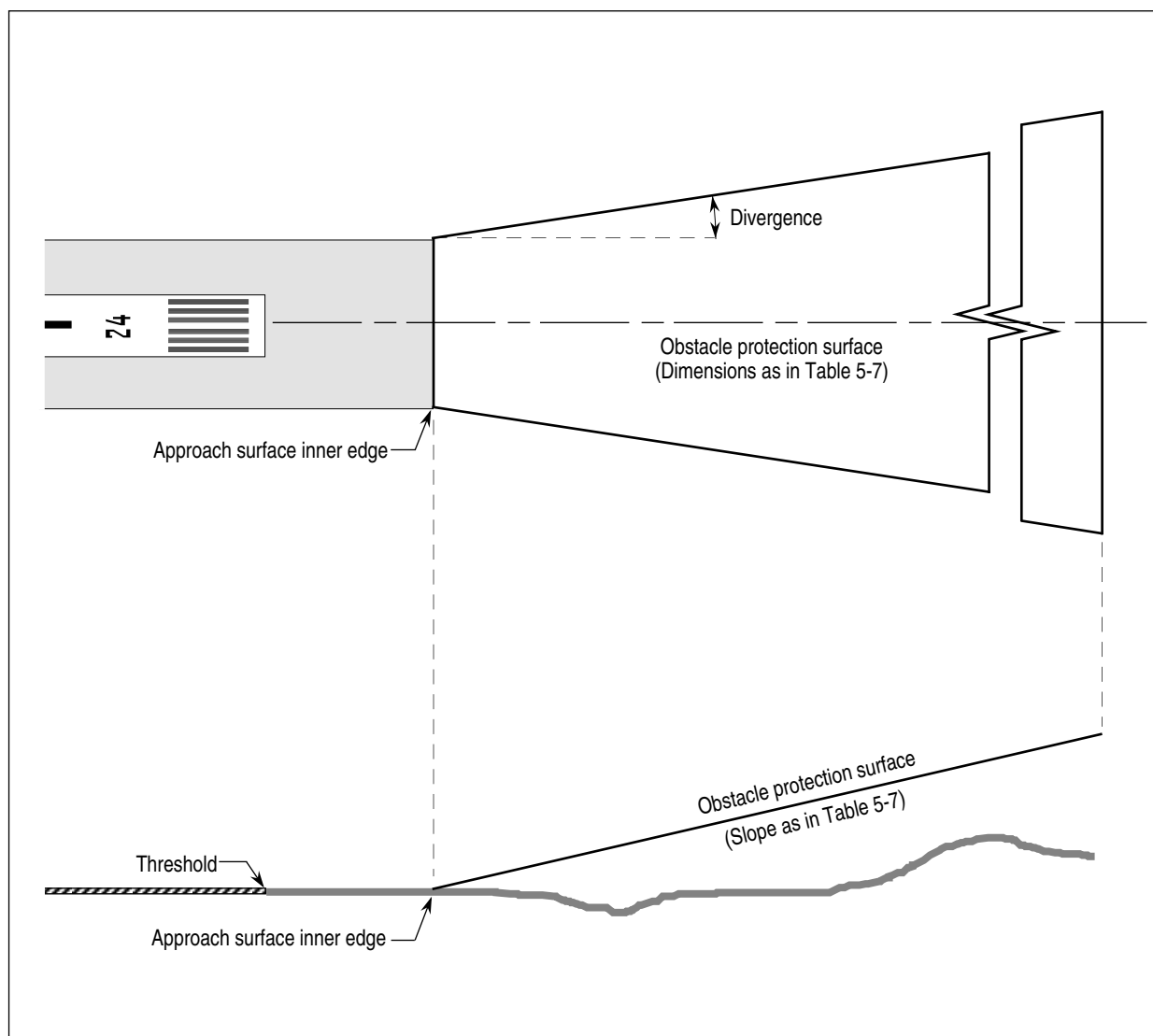

Figure 5-17. Obstacle protection surface for visual approach slope indicator systems

certifying authority, the object is shielded by an existing immovable object, or after aeronautical study it is determined that the object would not adversely affect the safety of operations of aeroplanes.

5.3.6.27 Standard.— Where an aeronautical study indicates that an existing object extending above an obstacle protection surface could adversely affect the safety of operations of aircraft one or more of the following measures shall be taken:

- a) suitably raise the approach slope of the system;
- b) reduce the azimuth spread of the system so that the object is outside the confines of the beam;
- c) displace the axis of the system and its associated obstacle protection surface by no more than 5° ;
- d) suitably displace the threshold; and
- e) where d) is found to be impracticable, suitably displace the system upwind of the threshold to provide an increase in threshold crossing height equal to the height of the object penetration.

Table 5-7. Dimensions and slopes of the Obstacle Protection Surfaces

SURFACE DIMENSIONS	RUNWAY TYPE / CODE NUMBER									
	Non-instrument				Non-Precision Instrument				Precision Instrument	
	(1)				(2)				(3)	
	Code number				Code number				Code number	
	1	2	3	4	1	2	3	4	1&2	3&4
Length of inner edge	30 m	30 m	45 m	75 m	45 m	45 m	75 m	150 m	75 m	150 m
Distance from threshold	30 m	60 m	60 m	60 m	60 m	60 m	60 m	60 m	60 m	60 m
Divergence (each side)	10%	10%	10%	10%	15%	15%	15%	15%	15%	15%
Total length	7500 m	7500 m	15000 m	15000 m	7500 m	7500 m	15000 m	15000 m	15000 m	15000 m
Slope (3° Glideslope)										
PAPI	----	1.93°	1.93°	1.93°	1.93°	1.93°	1.93°	1.93°	1.93°	1.93°
APAPI	1.85°	1.85°	----	----	1.85°	1.85°	----	----	----	----

Note.— No slope has been specified if a system is unlikely to be used on runway type/code number indicated.

5.3.7 AERODROME FLIGHT MANOEUVRING AREA HAZARD LIGHTS

Note 1.— The inclusion of detailed specifications for aerodrome flight manoeuvring area hazard lights in this section does not imply that hazard lights are required to be provided.

Note 2.— Where there are no obstacles higher than 100 m below the visual circuit altitude within 6 nm radius of the airport, aerodrome flight manoeuvring hazard lights are not required in order for the airport to be certified for night operations. Where the certifying authority has determined that an airport cannot be certified for night operations due to hazardous terrain, the installation of terrain hazard lights is intended to delineate the limits of a safe manoeuvring area to

permit the aircraft to safely arrive and depart from the airport at night under specified meteorological conditions.

General

5.3.7.1 Standard.— The dimensions of the flight manoeuvring area shall permit the critical aircraft arriving and departing the airport to manoeuvre safely in both the all engine operating or one engine out configuration.

5.3.7.2 Standard.— The obstacle free area shall be determined by drawing arcs of a radius of 2.3 NM centred on each runway threshold and joining those arcs with tangent lines and shall provide a minimum of 100 m vertical obstacle clearance (see Figure 5-18).

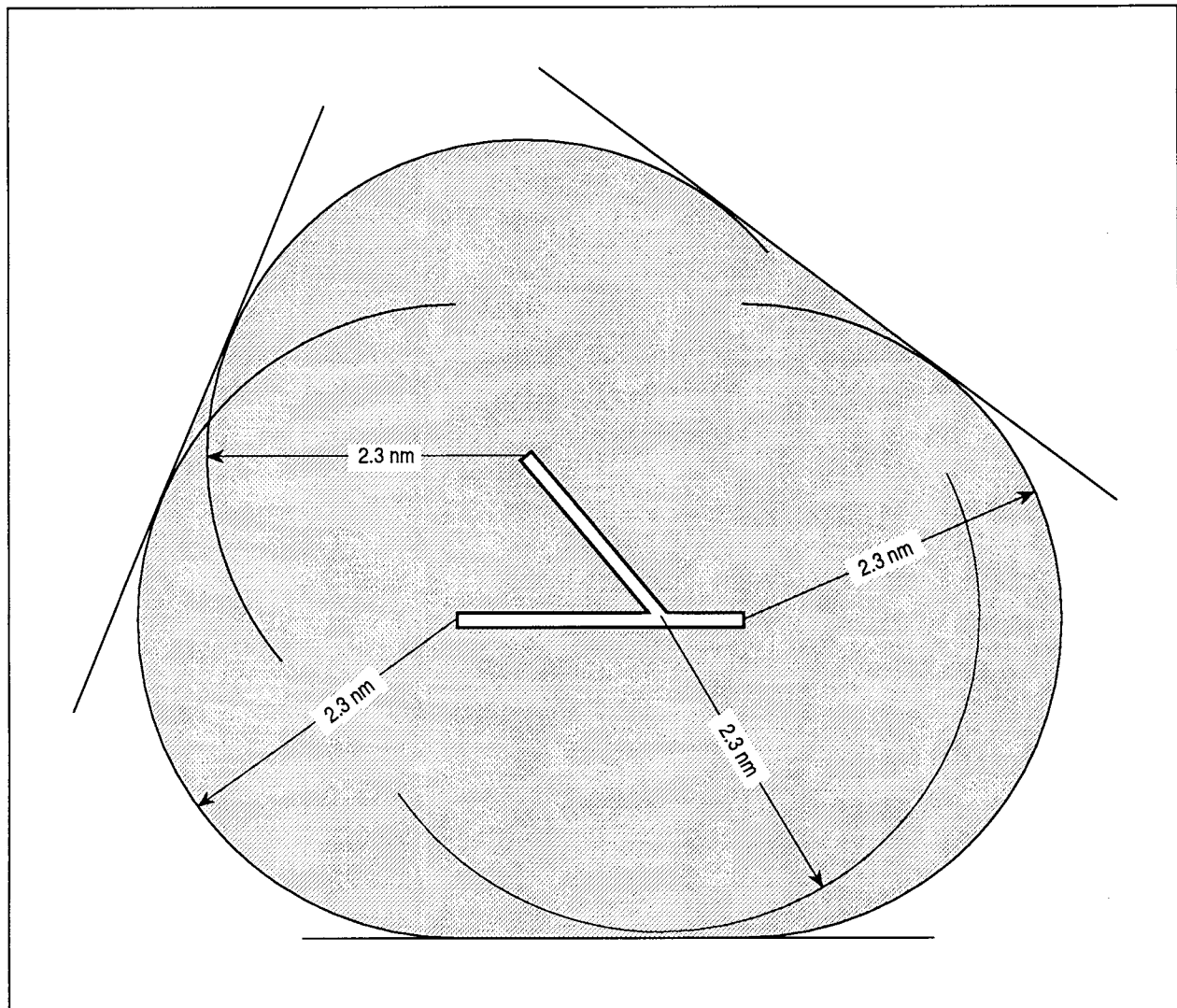

Figure 5-18. Flight manoeuvring area

5.3.7.3 Recommendation.— Where the obstacle free area is less than that prescribed in 5.3.7.2 the airport should not normally be considered for night operations.

Location

5.3.7.4 Standard.— The lights shall be located so as to be visible to aircraft operating in IMC at the highest authorized circling minimum descent altitude and for aircraft operating in VMC from any position within the traffic pattern.

5.3.7.5 Recommendation.— The lights should be located at approximately the same elevation.

5.3.7.6 Standard.— Each aerodrome flight manoeuvring area hazard beacon system shall consist of a group of lights positioned so as to define the extent of the safe manoeuvring area and so that each light in the system can be seen from the preceding one. Where appropriate, the lights of cities, towns etc may be included for aiding in the determination of the safe flight manoeuvring area.

Characteristics

5.3.7.7 Standard.— The aerodrome flight manoeuvring area hazard lights shall be omni-directional, medium intensity flashing red light or white flashing capacitor discharge light with an effective intensity in white of 2000 cd for night operation.

5.3.8 RUNWAY LEAD-IN LIGHTING SYSTEMS

Application

5.3.8.1 Recommendation.— A runway lead-in lighting system should be provided where it is desired to provide visual guidance along a specific approach path, for reasons such as avoiding hazardous terrain or for purposes of noise abatement.

Location

5.3.8.2 Recommendation.— A runway lead-in lighting system should consist of groups of lights positioned so as to define the desired approach path and so that one group may be

sighted from the preceding group. The interval between adjacent groups should not exceed approximately 1600 m.

Note.— *Runway lead-in lighting systems may be curved, straight or a combination thereof.*

5.3.8.3 Recommendation.— A runway lead-in lighting system should extend from a point as determined by the Certifying Authority, up to a point where the approach lighting system, if provided, or the runway or the runway lighting system is in view.

Characteristics

5.3.8.4 Recommendation.— Each group of lights of a runway lead-in lighting system should consist of at least three flashing lights in a linear or cluster configuration. The system may be augmented by steady burning lights where such lights would assist in identifying the system.

5.3.8.5 Recommendation.— The flashing lights should be white, and the steady burning lights gaseous discharge lights.

5.3.8.6 Recommendation.— Where practicable, the flashing lights in each group should flash in sequence towards the runway.

5.3.9 RUNWAY IDENTIFICATION LIGHTS (RILS)

Application

5.3.9.1 Recommendation.— Runway identification lights should be provided:

- a) at the threshold of a non-precision approach runway where it is not practical to provide other visual approach aids; or
- b) where extraneous non-aeronautical lights or lack of daytime contrast detract from the effectiveness of approach lights or where the threshold is difficult to identify and enhanced conspicuity is necessary; and
- c) where a runway threshold is permanently displaced from the runway extremity or temporarily displaced from the normal position and additional threshold conspicuity is necessary.

Location

5.3.9.2 Standard.— Runway identification lights shall be located symmetrically about the runway centre line at a lateral distance of 12 m from the runway edge.

5.3.9.3 Standard.— Runway identification lights shall be located at a longitudinal distance not greater than 30 m in front of the runway threshold.

5.3.9.4 Recommendation.— The lights should be installed in line with the runway threshold lights.

Note.— Although the recommended position is to place the lights in line with the runway threshold lights, a range up to 30 m from the threshold has been specified to allow for environmental and operational factors.

5.3.9.5 Standard.— The top of the light units shall not exceed a height of 1 m above the runway threshold.

Characteristics

5.3.9.6 Standard.— Runway identification lights shall be flashing white lights with a flash frequency between 80 and 120 per minute.

5.3.9.7 Standard.— Runway identification lights shall be aligned at an angle of 20° outward from the longitudinal axis of the runway and at an angle of 7.5° above the horizontal so as to be visible only in the direction of approach to the runway.

5.3.10 RUNWAY EDGE LIGHTS

Application

5.3.10.1 Standard.— Low intensity runway edge lights shall be provided for a runway intended for use at night where the code number is 1 or 2.

5.3.10.2 Recommendation.— Low intensity runway edge lights should be provided for a non-precision approach runway intended for use by day when the code number is 1 or 2.

5.3.10.3 Standard.— Medium intensity runway edge lights shall be provided for a runway intended for use at night where the code number is 3 or 4.

5.3.10.4 Recommendation.— Medium intensity runway edge lights should be provided for a non-precision approach runway intended for use by day when the code number is 3 or 4.

5.3.10.5 Standard.— High intensity runway edge lights shall be provided for a precision approach runway intended for use by day or night.

5.3.10.6 Recommendation.— High intensity runway edge lights should be provided on a runway intended for take-off with an operating minimum below an RVR of the order of 2600 ft (800 m) by day.

Location

5.3.10.7 Standard.— Runway edge lights shall be placed along the full length of the runway and shall be in two parallel rows equidistant from the centre line.

5.3.10.8 Standard.— Runway edge lights shall be placed along the edges of the area declared for use as the runway or outside the edges of the area at a distance of up to 1.5 m. Where the accumulation of snow at the runway edge creates maintenance problems the lights may be located up to 3 m from the runway edge.

5.3.10.9 Recommendation.— Where the width of the area which could be declared as runway exceeds 60 m, the distance between the rows of lights should be determined taking into account the nature of the operations, the light distribution characteristics of the runway edge lights, and other visual aids serving the runway.

5.3.10.10 Standard.— The lights shall be uniformly spaced in rows at intervals of not more than 60 m. The lights on opposite sides of the runway axis shall be on lines at right angles to that axis. At intersections with runways or taxiways, lights may be spaced irregularly or omitted, provided that adequate guidance remains available to the pilot and the spacing is not greater than 120 m.

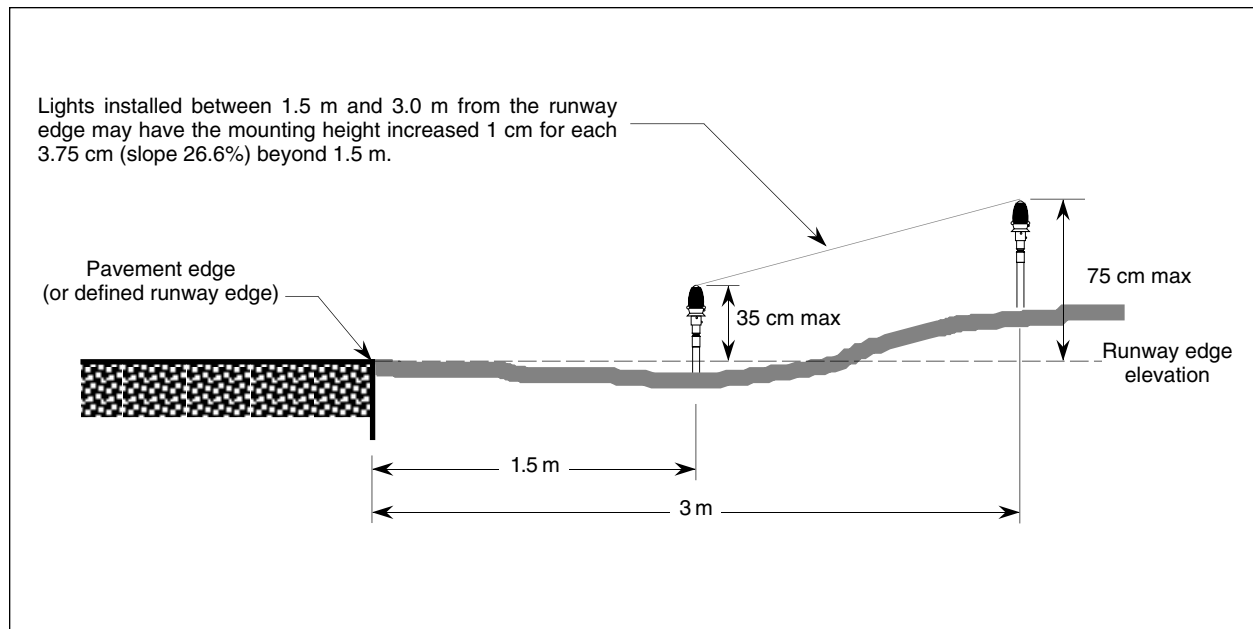

Figure 5-19. Runway edge light mounting height

Characteristics

5.3.10.11 Standard.— Runway edge lights shall be fixed lights showing variable white, except that:

- a) in the case of a displaced threshold, the lights between the beginning of the runway and the displaced threshold shall show blue; and
- b) a section of the lights 600 m or one-third of the runway length, whichever is the less, at the remote end of the runway from the end at which the take-off run is started, may show yellow.

5.3.10.12 Standard.— The runway edge lights shall show at all angles in azimuth necessary to provide guidance to a pilot landing or taking off in either direction. When the runway edge lights are intended to provide circling guidance, they shall show at all angles in azimuth.

Note.— *Asymmetric or symmetric lenses may be installed if there is no requirement for circling guidance.*

5.3.10.13 Standard.— In all angles of azimuth required in 5.3.10.12, runway edge lights shall show at angles up to 15° above the horizontal with an intensity adequate for the conditions of visibility and ambient light in which use of the

runway for take-off or landing is intended. In any case, the intensity shall be at least 50 cd except that at an aerodrome without extraneous lighting the intensity of the lights may be reduced to not less than 25 cd to avoid dazzling the pilot.

5.3.10.14 Standard.— Runway edge lights on a precision approach runway shall be in accordance with the specifications of Appendix B, Sections B.1.10 or B.1.11.

5.3.10.15 Standard.— Runway edge lights shall be mounted to a maximum height of 35 cm above the runway edge except they may be raised to a maximum height of 75 cm when located 3 m from the runway edge using a ratio of 1 cm per 3.75 cm as the light is moved out from the 1.5 m to the 3 m position (see Figure 5-18). In areas with special maintenance problems, such as high snow fall, runway edge light mounting heights in excess of the values given shall require the approval of the Certifying Authority. In all cases a minimum clearance of 15 cm shall be provided between the light and any overhanging part of the aircraft expected to use the runway when its main landing gear is located at the edge of the pavement.

5.3.10.16 Standard.— Runway edge light mountings shall be frangible.

5.3.11 RUNWAY THRESHOLD and WING BAR LIGHTS

Application of runway threshold lights

5.3.11.1 Standard.— Runway threshold lights shall be provided for a runway equipped with runway edge lights except on a non-instrument or non-precision approach runway where the threshold is displaced and wing bar lights are provided.

Description of runway threshold lights

5.3.11.2 Standard.— Runway threshold lights shall consist of:

- a) on a runway less than 45 m in width, six lights arranged in two groups, and on a runway 45 m and greater in width, eight lights arranged in two groups;
- b) in addition to those lights required by (a) above, when a precision approach runway category I lighting system is installed, additional lights as required to achieve a maximum spacing of 3 m between individual lights; and
- c) in addition to those lights required by (a) and (b) above, on a precision approach runway category II or III, additional lights as required to achieve a maximum spacing of 1.5 m between individual lights.

Location of runway threshold lights

Note.— *Minor adjustments to the specifications for the spacing distances between lights are permitted for the purposes of uniformity provided that the intent as to the number of lights provided in a configuration is maintained.*

5.3.11.3 Standard.— When a threshold is at the extremity of a runway, the threshold lights shall be placed in a row at right angles to the runway axis as near to the extremity of the runway as possible and, in any case, not more than 3 m outside the extremity.

5.3.11.4 Standard.— When a threshold is displaced from the extremity of a runway, threshold lights shall be placed in a row at right angles to the runway axis at the displaced threshold.

5.3.11.5 Standard.— The runway threshold lights described in 5.3.11.2 (a), shall be placed in two groups symmetrically disposed about the runway centre line with the outermost runway threshold lights positioned to align with the runway edge lights and the remainder spaced at intervals of 3 m.

5.3.11.6 Standard.— On a precision approach runway category I, those additional lights described in 5.3.11.2 (b), shall be placed between the inner most lights described in 5.3.11.5 and spaced at uniform intervals not to exceed 3 m.

Note.— *It is intended that the total number of lights positioned in 5.3.11.5 and 5.3.11.6 would be spaced at uniform intervals.*

5.3.11.7 Standard.— On a precision approach runway category II or III, those additional lights described in 5.3.11.2 (b), shall be placed between the lights described in 5.3.11.5 and 5.3.11.6 so as to achieve a uniform spacing of 1.5 m between individual lights.

Application of wing bar lights

5.3.11.8 Standard.— Wing bar lights shall be provided on a runway where the threshold is displaced to indicate the location of the displaced threshold.

5.3.11.9 Standard.— Wing bar lights shall be provided on a precision approach runway category II or III.

Description of wing bar lights

5.3.11.10 Standard.— Wing bar lights shall consist of two groups of lights (ie. wing bars) each consisting of;

- a) three lights when used to mark the location of a displaced threshold for a runway 30 m or less in width;
- b) four lights when used to mark the location of a displaced threshold for a runway greater than 30 m in width but not greater than 45 m in width;
- c) five lights when used to mark the location of a displaced threshold for a runway greater than 45 m in width; and

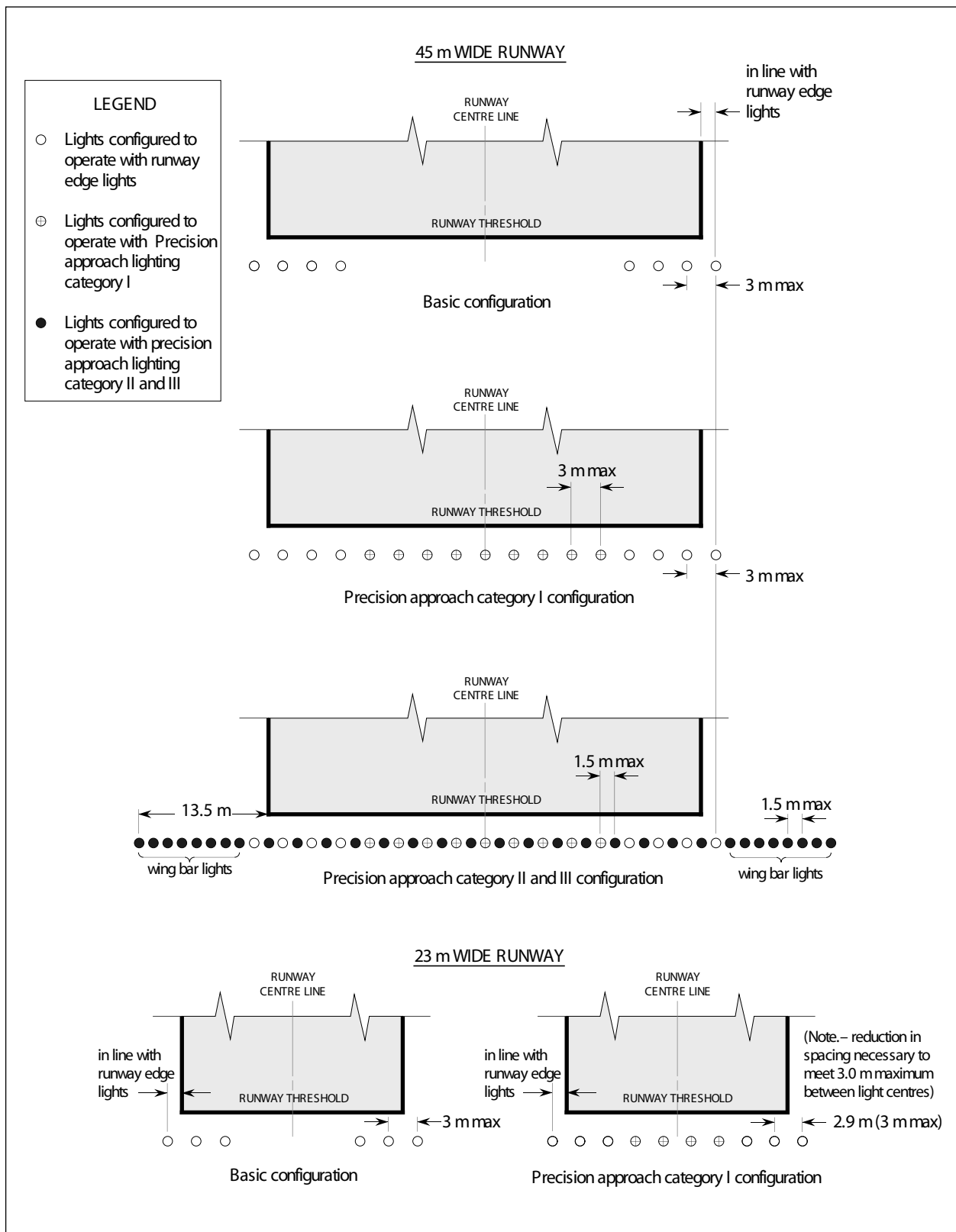

Figure 5-20 Examples of threshold and wing bar lights

- d) seven or eight lights when provided on a precision approach runway category II or III.

Location of wing bar lights

5.3.11.11 Standard.— To indicate the location of a displaced threshold, wing bar lights shall be symmetrically disposed on each side of the runway at the displaced threshold. Each wing bar shall be at right angles to the line of runway edge lights with the innermost light located 3 m outside the line of runway edge lights and the remainder spaced at intervals of 3 m.

5.3.11.12 Recommendation.— Where practicable, a wing bar indicating the location of a displaced threshold should be aligned with a runway edge light.

5.3.11.13 Standard.— For a precision approach runway category II or III, wing bar lights shall be symmetrically disposed on each side of the runway threshold lights, extending to 13.5 m from the runway edge with uniform spacing between each light of 1.5 m.

Note.— On runways where the runway edge lighting is placed 3 m from the edge, seven lights are required in each wing bar. On runways where the runway edge lighting is placed 1.5 m from the edge, eight lights are required in each wing bar.

Characteristics of runway threshold and wing bar lights

5.3.11.14 Standard.— Runway threshold and wing bar lights shall be fixed unidirectional lights showing green in the direction of approach to the runway (see Figure 5-20). The intensity and beam spread of the lights shall be adequate for the conditions of visibility and ambient light in which use of the runway is intended.

Note.— Bidirectional fixtures are permissible to facilitate the requirements of 5.3.11 and 5.3.12.

5.3.11.15 Standard.— The lights required by 5.3.11.2 (a) and 5.3.11.8 shall be configured to be illuminated with the runway edge lights at a compatible intensity.

5.3.11.16 Standard.— The lights required by 5.3.11.2 (b) shall be configured to be illuminated with the precision approach category I

lighting system at a compatible intensity.

5.3.11.17 Standard.— The lights required by 5.3.11.2 (c) and 5.2.11.9 shall be configured to be illuminated with the precision approach category II and III lighting system at a compatible intensity.

5.3.11.18 Standard.— Runway threshold lights on a precision approach runway shall be in accordance with the specifications of Appendix B, section B.1.3.

5.3.11.19 Standard.— Wing bar lights on a precision approach runway shall be in accordance with the specifications of Appendix B, section B.1.4.

5.3.11.20 Standard.— Threshold and wing bar lights using high intensity fixtures (PAR 56 lamps) shall be aligned vertically with an angle of elevation 6.1 degrees.

5.3.11.21 Standard.— Threshold lights using medium intensity fixtures (PAR 38 lamps) shall be aligned vertically with an angle of elevation 3.1 degrees.

5.3.11.22 Standard.— Runway threshold and wing bar light shall be aligned laterally with their beam axis parallel to the runway centre line.

5.3.11.23 Standard.— Runway threshold and wing bar light mountings shall be frangible.

5.3.12 RUNWAY END LIGHTS

Application

5.3.12.1 Standard.— Runway end lights shall be provided for a runway equipped with runway edge lights.

Description

5.3.12.2 Standard.— Runway end lights on a runway less than 45 m in width shall consist of six lights arranged in two groups, and on a runway 45 m and greater in width, eight lights arranged in two groups.

Location

5.3.12.3 Standard.— Runway end lights shall be placed on a line at right angles to the runway axis as near to the end of the runway as possible and, in any case, not more than 3 m outside of the end.

5.3.12.4 Standard.— Runway end lighting shall be placed in two groups symmetrically disposed about the runway centre line with the outermost runway end lights positioned to align with the runway edge lights and the remainder spaced at intervals of 3 m.

Characteristics

5.3.12.5 Standard.— Runway end lights shall be fixed unidirectional lights showing red in the direction of the runway. The intensity and beam spread of the lights shall be adequate for the conditions of visibility and ambient light in which use of the runway is intended.

Note.— When the threshold is at the runway extremity, bidirectional fixtures are permissible to facilitate the requirements of 5.3.11 and 5.3.12.

5.3.12.6 Standard.— Runway end lights on a precision approach runway shall be in accordance with the specifications of Appendix B, section B.1.9.

5.3.12.7 Standard.— Runway end light mountings shall be frangible.

5.3.13 RUNWAY CENTRE LINE LIGHTS

Application

5.3.13.1 Standard.— Runway centre line lights shall be provided on a precision approach runway category II or III.

5.3.13.2 Recommendation.— Runway centre line lights should be provided on a precision approach runway category I, particularly when the runway is used by aircraft with high landing speeds or where the width between the runway edge lights is greater than 50 m.

5.3.13.3 Standard.— Runway centre line lights shall be provided on a runway intended to be used for take-off with an operating minimum below an RVR of the order of 1400 ft (400 m).

5.3.13.4 Recommendation.— Runway centre line lights should be provided on a runway intended to be used for take-off with an operating minimum of an RVR of the order of 1400 ft (400 m) or higher when used by aeroplanes with a very high take-off speed, particularly where the width between the runway edge lights is greater than 50 m.

5.3.13.5 Recommendation.— Centre line guidance for take-off from the beginning of a runway to a displaced threshold should be provided by:

- a) an approach lighting system if its characteristics and intensity settings afford the guidance required during take-off and it does not dazzle the pilot of an aircraft taking off; or
- b) runway centre line lights; or
- c) barrettes of at least 3 m length and spaced at uniform intervals of 30 m, designed so that their photometric characteristics and intensity setting afford the guidance required during take-off without dazzling the pilot of an aircraft taking off.

Location

5.3.13.6 Standard.— Runway centre line lights shall be located along the centre line of the runway, except that the lights may be uniformly offset to the same side of the runway centre line by not more than 60 cm where it is not practicable to locate them along the centre line. The lights shall be located from the threshold to the end at a longitudinal spacing approximately:

- 7.5 m or 15 m on a precision approach runway category III;
- 15 m on a precision approach runway category II or on runways intended to be used for take-off with an operating minimum below an RVR of the order of 1400 ft (400 m); and
- 15 m or 30 m on a precision approach runway category I or other runways on which lights are provided.

Characteristics

5.3.13.7 Standard.— Runway centre line lights shall be fixed lights showing variable white from the threshold to the point 900 m from the runway end; alternate red and variable white from 900 m to 300 m from the runway end; and red from 300 m to the runway end, except that:

- a) where the runway centre line lights are spaced at 7.5 m intervals, alternate pairs of red and variable white lights shall be used on the section from 900 m to 300 m from the runway end; and
- b) for runways less than 1800 m in length, the alternate red and variable white lights shall extend from the mid point of the runway usable for landing to 300 m from the runway end.

Note 1.— Care is required in the design of the electrical system to ensure that failure of part of the electrical system will not result in a false indication of the runway distance remaining.

Note 2.— Bidirectional lights may be used with the appropriate filter in each direction to facilitate the provision of runway centre line lighting on the opposite direction runway.

5.3.13.8 Standard.— Runway centre line lights shall be in accordance with the specifications of Appendix B, Sections B.1.6, B.1.7, or B.1.8.

5.3.13.9 Standard.— Where necessary, provision shall be made to extinguish those centre line lights specified in 5.3.13.5 (b) or reset the intensity of the approach lighting system or barrettes when the runway is being used for landing.

5.3.14 RUNWAY TOUCHDOWN ZONE LIGHTS

Application

5.3.14.1 Standard.— Touchdown zone lights shall be provided in the touchdown zone of a precision approach runway category II or III.

Location

5.3.14.2 Standard.— Touchdown zone lights shall extend from the threshold for a longitudinal distance of 900 m, except that, on runways less than 1800 m in length, the system shall be shortened so that it does not extend beyond the midpoint of the runway. The pattern shall be formed by pairs of barrettes symmetrically located about the runway centre line. The lateral spacing between the innermost lights of a pair of barrettes shall be equal to the lateral spacing selected for the touchdown zone marking. The longitudinal spacing between pairs of barrettes shall be 30 m.

Characteristics

5.3.14.3 Standard.— A barrette shall be composed of at least three lights with a spacing between the lights of not more than 1.5 m.

5.3.14.4 Recommendation.— A barrette should be not less than 3 m nor more than 4.5 m in length.

5.3.14.5 Standard.— Touchdown zone lights shall be fixed unidirectional lights showing variable white.

5.3.14.6 Standard.— Touchdown zone lights shall be in accordance with the specifications of Appendix B, section B.1.5.

5.3.15 STOPWAY LIGHTS

Application

5.3.15.1 Standard.— Stopway lights shall be provided for a stopway intended for use at night.

Location

5.3.15.2 Standard.— Stopway lights shall be placed along the full length of the stopway and shall be in two parallel rows that are equidistant from the centre line and coincident with the rows of the runway edge lights. Stopway lights shall also be provided across the end of a stopway on a line at right angles to the stopway axis as near to the end of the stopway as possible and, in any case, not more than 3 m outside the end.

Characteristics

5.3.15.3 Standard.— Stopway lights shall be fixed unidirectional lights showing red in the direction of the runway.

5.3.15.4 Standard.— Stopway light mountings shall be frangible.

5.3.16 TAXIWAY CENTRE LINE LIGHTS

Application

5.3.16.1 Standard.— Taxiway centre line lights shall be provided on an exit taxiway, taxiway, apron, and apron stand taxiway intended for use in runway visual range conditions less than a value of the order of 1400 ft (400 m), in such a manner as to provide continuous guidance between the runway centre line and the point on the apron where aircraft commence manoeuvring for parking, except that these lights need not be provided where there is a low volume of traffic and taxiway edge lights and centre line marking provide adequate guidance.

Note.—See 5.3.23 concerning the provision of aircraft stand manoeuvring guidance lights.

5.3.16.2 Recommendation.— Taxiway centre line lights should be provided on a taxiway intended for use at night in runway visual range conditions of the order of 1400 ft (400 m) or greater, and particularly on complex taxiway intersections and exit taxiways, except that these lights need not be provided where there is a low volume of traffic and taxiway edge lights and centre line marking provide adequate guidance.

Note 1.— Where there may be a need to delineate the edges of a taxiway, e.g. on a rapid exit taxiway, narrow taxiway or in snow conditions, this may be done with taxiway edge lights or markers.

Note 2.— See 5.5.5 for taxiway edge markers.

5.3.16.3 Standard.— Taxiway centre line lights shall be provided on a runway forming part of a standard taxi-route and intended for taxiing in runway visual range conditions less than a value of the order of 1400 ft (400 m) except that these lights need not be provided where there is a low

volume of traffic and taxiway edge lights and centre line marking provide adequate guidance.

Note.— See 8.1.2.2 for provisions concerning the interlocking of runway and taxiway lighting systems.

Characteristics

5.3.16.4 Standard.— With the exception of an exit taxiway, taxiway centre line lights on a taxiway and on a runway forming part of a recognized taxi-route, shall be fixed lights showing green with beam dimensions such that the light is visible only from aircraft on or in the vicinity of the taxiway.

5.3.16.5 Standard.— Where aircraft follow the same centreline in both directions the centreline lights shall be bidirectional.

5.3.16.6 Standard.— Taxiway centre line lights on an exit taxiway shall be fixed lights. Alternate taxiway centre line lights shall show green and yellow from their beginning near the runway centre line to the outer perimeter of the ILS/MLS critical/sensitive area or the taxi-holding position, whichever is farthest from the runway; and thereafter all lights shall show green. (See Figure 5–21). The light nearest to the perimeter shall always show yellow. Where aircraft may follow the same centre line in both directions, all the centre line lights shall show green to aircraft approaching the runway.

Note 1.—Care is necessary to limit the light distribution of green lights on or near a runway so as to avoid possible confusion with threshold lights.

Note 2.—For yellow filter characteristics see Appendix A.

Note 3.— The size of the ILS/MLS critical/sensitive area depends on the characteristics of the associated ILS or MLS. Some guidance is provided in TP 1247, Land Use in the Vicinity of Airports.

5.3.16.7 Standard.— Taxiway centre line lights shall be in accordance with the specifications of:

- a) Appendix B, section B.2.1, B.2.2 or B.2.3 for taxiways intended for use in runway visual

range conditions of less than a value of the order of 1400 ft (400 m); and

- b) Appendix B, section B.2.4 or B.2.5 for other taxiways.

Location

5.3.16.8 Recommendation.— Taxiway centre line lights should normally be located on the taxiway centre line marking, except that they may be offset by not more than 30 cm where it is not practicable to locate them on the marking.

TAXIWAY CENTRE LINE LIGHTS ON TAXIWAYS

Location

5.3.16.9 Standard.— Taxiway centre line lights on a straight section of a taxiway shall be spaced at longitudinal intervals of not more than 30 m, except that:

- a) on a taxiway intended for use in RVR conditions of less than a value of the order of 1400 ft (400 m), the longitudinal spacing shall not exceed 15 m.
- b) larger intervals not exceeding 60 m may be used where, because of the prevailing meteorological conditions, adequate guidance is provided by such spacing; and
- c) intervals less than 30 m should be provided on short straight sections.

5.3.16.10 Standard.— Taxiway centre line lights on a taxiway curve shall continue from the straight portion of the taxiway at a constant distance from the outside edge of the taxiway curve. The lights shall be spaced at intervals such that a clear indication of the curve is provided.

5.3.16.11 Standard.— On a taxiway intended for use in RVR conditions of less than a value of the order of 1400 ft (400 m), the lights on a curve shall not exceed a spacing of 15 m and on a curve of less than 400 m radius the lights shall be spaced at intervals of not greater than 7.5 m. This spacing should extend for 60 m before and after the curve.

5.3.16.12 Recommendation.— On a taxiway intended for use in RVR conditions of 1400 ft (400 m) or greater, the lights on a curve should not exceed a spacing of:

<u>Curve radius</u>	<u>Light spacing</u>
up to 400 m	7.5 m
401 m to 899 m	15 m
900 m or greater	30 m

This spacing should extend for 60 m before and after the curve.

Note.— See 3.7.5 and Figure 3–1.

TAXIWAY CENTRE LINE LIGHTS ON RAPID EXIT TAXIWAYS

Location

5.3.16.13 Standard.— Taxiway centre line lights on a rapid exit taxiway shall commence at a point at least 60 m before the beginning of the taxiway centre line curve and continue beyond the end of the curve to a point on the centre line of the taxiway where an aircraft can be expected to reach normal taxiing speed. The lights on that portion parallel to the runway centre line should always be at least 60 cm from any row of runway centre line lights, as shown in Figure 5–21.

5.3.16.14 Standard.— The lights should be spaced at longitudinal intervals of not more than 15 m.

TAXIWAY CENTRE LINE LIGHTS ON OTHER EXIT TAXIWAYS

Location

5.3.16.15 Recommendation.— Taxiway centre line lights on exit taxiways other than rapid exit taxiways should commence at the point where the taxiway centre line marking begins to curve from the runway centre line, and follow the curved taxiway centre line marking at least to the point where the marking leaves the runway. The first light should be at least 60 cm from any row of runway centre line lights, as shown in Figure 5–21.

Note.— See 5.2.8 for location of taxiway centre line markings.

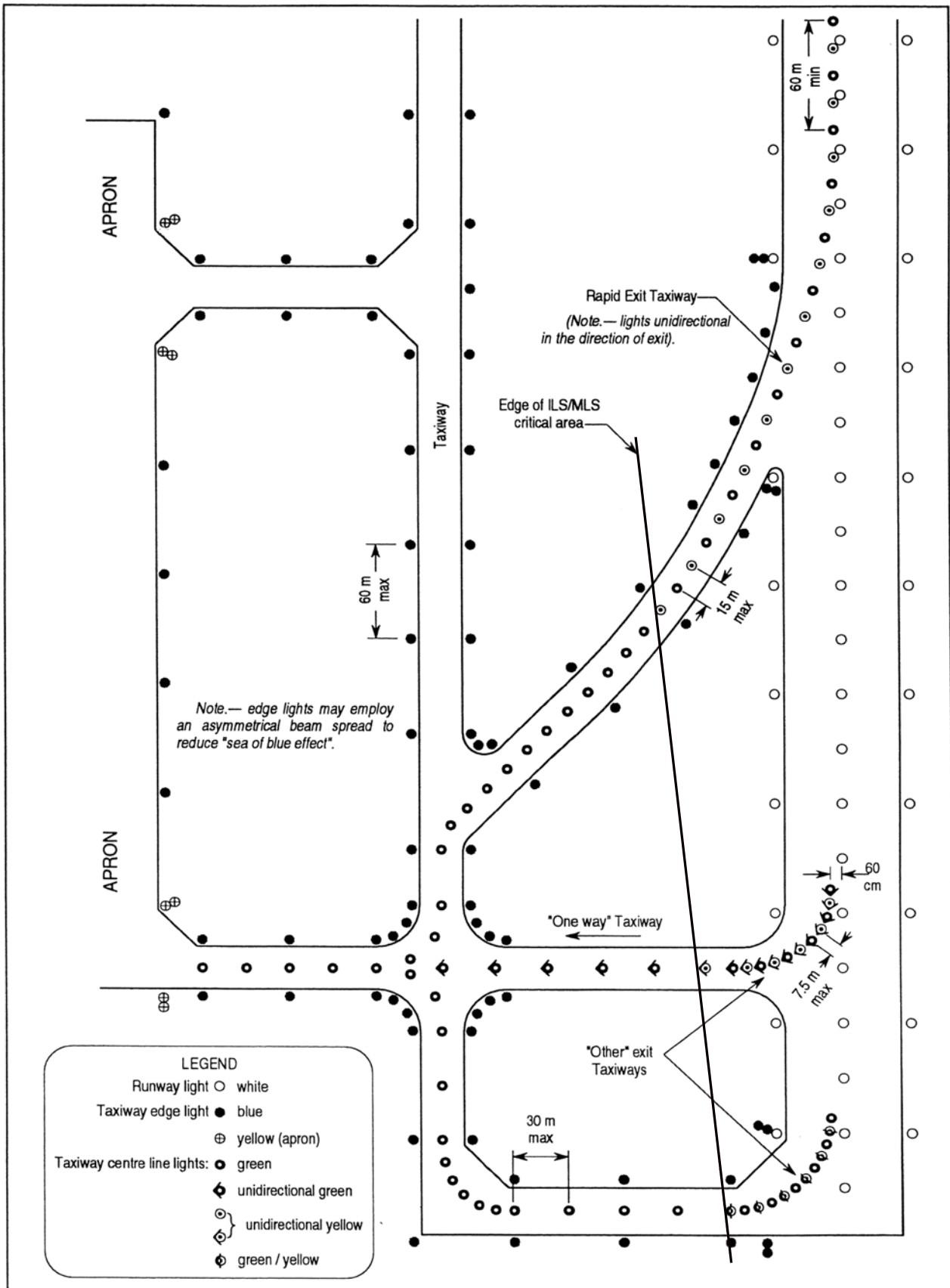

Figure 5-21. Taxiway lighting

5.3.16.16 Recommendation.— The lights should be spaced at longitudinal intervals of not more than 7.5 m.

TAXIWAY CENTRE LINE LIGHTS ON RUNWAYS

5.3.16.17 Recommendation.— Taxiway centre line lights on a runway forming part of a recognized taxi-route and intended for taxiing in RVR conditions of less than a value of the order of 1400 ft (400 m) should be spaced at longitudinal intervals not exceeding 15 m.

5.3.17 TAXIWAY EDGE LIGHTS

Application

5.3.17.1 Standard.— Taxiway edge lights shall be provided on a holding bay, apron, etc. intended for use at night and on a taxiway not provided with taxiway centre line lights and intended for use at night, except that :

- a) taxiway edge lights need not be provided on taxiways intended for use at night in association with non-instrument runways where the code number is 1 or 2 provided that retro-reflective taxiway edge markers are installed.
- b) taxiway edge lights need not be provided on aprons where considering the nature of the operations, adequate guidance can be achieved by surface illumination of taxiway edge markers.
- c) retro-reflective markers may be used in lieu of taxiway edge lights on private taxiways and aprons.

Note.— See 5.5.5 for taxiway edge markers.

5.3.17.2 Standard.— Taxiway edge lights shall be provided on a runway forming part of a standard taxi-route and intended for taxiing at night where the runway is not provided with taxiway centre lights, except that taxiway edge lights need not be provided where, considering the nature of the operations, adequate guidance can be achieved by surface illumination or other means.

Location

5.3.17.3 Standard.— Taxiway edge lights on a straight section of a taxiway and on a runway forming part of a recognized taxi route shall be spaced at uniform longitudinal intervals of not more than 60 m.

5.3.17.4 Recommendation.— The lights on a curve should be spaced at intervals less than 60 m so that a clear indication of the curve is provided.

Note.— Where necessary at a taxiway/taxiway intersection, additional blue lights (eg. double) may be installed to improve conspicuity of the intersection.

5.3.17.5 Recommendation.— The lights should be located as near as practicable to the edges of the taxiway, holding bay, apron, or runway, etc., or outside the edges at a distance of not more than 3 m.

5.3.17.6 Standard.— The intersection of a taxiway with a runway shall be indicated by placing two blue edge lights on each side of and adjacent to the taxiway/runway intersection.

5.3.17.7 Standard.— The intersection of a taxiway with an apron shall be indicated by placing two yellow edge lights on each side of and adjacent to the taxiway/apron intersection.

5.3.17.8 Standard.— The two lights provided in accordance with 5.3.17.6 and 5.3.17.7 shall be located so that one light is positioned in line with the other edge lights. The second shall be positioned not more than 0.6 m from the first, and aligned to be equidistant from the edge(s) of the pavement on each side of the first light.

Characteristics

5.3.17.9 Standard.— Taxiway edge lights shall be fixed lights showing blue. The lights shall show up to at least 30° above the horizontal and at all angles in azimuth necessary to provide guidance to a pilot taxiing in either direction. At an intersection, exit or curve the lights shall be shielded as far as practicable so that they cannot be seen in angles of azimuth in which they may be confused with other lights.

Note.— See paragraph 5.5.5 for characteristics of retro-reflective taxiway edge markers.

5.3.17.10 Standard.— Taxiway edge light mountings shall be frangible

5.3.18 STOP BARS (see also 5.3.24)

Application

Note.— The provision of stop bars requires their control by air traffic services.

5.3.18.1 Standard.— A stop bar shall be provided at every taxi-holding position serving a runway when it is intended that the runway will be used in runway visual range conditions less than a value of the order of 1400 ft (400 m) except where operational procedures exist to limit to one at any time the number of aircraft on the manoeuvring area.

5.3.18.2 Recommendation.— A stop bar should be provided at every taxi-holding position serving a runway when it is intended that the runway will be used in runway visual range conditions of values between the order of 1400 ft (400 m) and 2600 ft (800 m) except where operational procedures exist to limit to one at any time the number of aircraft on the manoeuvring area.

Note.— There is a recommendation before ICAO that the provisions of 5.3.18.2 will become a standard as of 01 January 1999

5.3.18.3 Recommendation.— One or more stop bars, as appropriate, should be provided at a taxiway intersection or taxi-holding position when it is desired to supplement markings with lights and to provide traffic control by visual means.

5.3.18.4 Recommendation.— Where the normal stop bar lights might be obscured (from a pilot's view), or where a pilot may be required to stop the aircraft in a position so close to the lights that they are blocked from view by the structure of the aircraft, then a pair of elevated lights should be added to each end of the stop bar.

Location

5.3.18.5 Standard.— Stop bars shall be located across the taxiway at the point where it is desired that traffic stop. Where the additional lights specified in 5.3.18.4 are provided, these lights shall be located not less than 3 m from the taxiway edge.

Characteristics

5.3.18.6 Standard.— Stop bars shall consist of lights spaced at intervals of 3 m across the taxiway showing red in the intended direction(s) of approach to the intersection or taxi-holding position.

5.3.18.7 Standard.— Stop bars installed at a taxi-holding position shall be unidirectional and shall show red in the direction of approach to the runway.

5.3.18.8 Standard.— Where the additional lights specified in 5.3.18.4 are provided, these lights shall have the same characteristics as the lights in the stop bar, but shall be visible to approaching aircraft up to the stop bar position.

5.3.18.9 Standard.— Selectively switchable stop bars at a taxi-holding position shall be installed in conjunction with taxiway centre line lights extending from the stop bar to the runway centreline in accordance with the specifications contained in 5.3.16.15.

5.3.18.10 Standard.— Selectively switchable stop bars other than at a taxi-holding position shall be installed in conjunction with at least three taxiway centre line lights (extending for at least 90 m from the stop bar) in the direction that it is intended for an aircraft to proceed from the stop bar.

Note.— See 5.3.16.9 to 5.3.16.17 for provisions concerning the spacing of taxiway centre line lights.

5.3.18.11 Recommendation.— The intensity in red light and beam spreads of stop bar lights should be in accordance with the specifications in Appendix B, Sections B.2.1 through B.2.5, as appropriate.

5.3.18.12 Standard.— The lighting circuit shall be designed so that:

- a) stop bars located across entrance taxiways are selectively switchable;
- b) stop bars located across taxiways intended to be used only as exit taxiways are switchable selectively or in groups;
- c) when a stop bar is illuminated, the taxiway centre line lights specified in 5.3.18.8 and 5.3.18.9 installed beyond the stop bar shall be extinguished; and
- d) stop bars shall be interlocked with the taxiway centre line lights so that when the centre line lights beyond the stop bar are illuminated the stop bar is extinguished and vice versa.

Note 1.— A stop bar is switched on to indicate that traffic stop and switched off to indicate that traffic proceed.

Note 2.— Care is required in the design of the electrical system to ensure that all of the lights of a stop bar will not fail at the same time.

Note 3.— See 8.8 for provisions for selective switching of stop bars and taxiway centre line lights.

5.3.19 TAXIWAY INTERSECTION LIGHTS

Note.— See 5.2.10 for specifications on taxiway intersection marking

Application

5.3.19.1 Recommendation.— Taxiway intersection lights should be provided at a taxiway intersection where it is desirable to define a specific aeroplane holding limit and there is no need for stop-and-go signals as provided by a stop bar.

Location

5.3.19.2 Standard.— Taxiway intersection lights shall be located in line with the taxiway intersection marking. Where there is no taxiway intersection marking, the lights shall be installed at least 60 m from the centreline of the

intersecting taxiway where the code number is 3 or 4 and at least 40 m where the code number is 1 or 2.

Characteristics

5.3.19.3 Standard.— Taxiway intersection lighting shall consist of at least three fixed unidirectional lights showing yellow in the direction of approach to the intersection with a light distribution similar to taxiway centre line lights if provided. The lights shall be disposed symmetrically about, and at 90° to, the taxiway centre line, with individual lights spaced 1.5 m apart.

5.3.20 RUNWAY GUARD LIGHTS

Application

5.3.20.1 Standard.— Runway guard lights, Configuration A, shall be provided at each taxiway/runway intersection associated with a runway intended for use in :

- a) runway visual range conditions less than a value of the order of 2600 ft (800 m) where a stop bar is not installed; and
- b) runway visual range conditions of values between the order of 2600 ft (800 m) and 4000 ft (1 200 m) where the traffic density is high.

5.3.20.2 Recommendation.— Runway guard lights, Configuration A, should be provided at each taxiway/runway intersection associated with a runway intended for use in:

- a) runway visual range conditions less than a value of the order of 2600 ft (800 m) where a stop bar is installed; and
- b) runway visual range conditions of values between the order of 2600 ft (800 m) and 4000 ft (1200 m) where the traffic density is not high.

5.3.20.3 Recommendation.— Except as provided in 5.3.20.4, runway guard lights, Configuration A, or configuration B or both, should be provided at each taxiway/runway intersection where enhanced conspicuity of the

taxiway/runway intersection is needed, such as on a wide throat taxiway.

Note.— *it is intended to upgrade the recommendations contained in 5.3.20.2 and 5.3.20.3 to standards by January 1, 2002.*

5.3.20.4 Standard.— Runway guard lights, configuration B shall not be collocated with a stop bar.

Location

Note.— *See Figure 5–6 for taxi–holding position marking patterns.*

5.3.20.5 Standard.— Runway guard lights, configuration A, shall be located at each side of the taxiway at a distance from the runway centre line not less than that specified for a take–off runway in Table 3–2

5.3.20.6 Standard.— Runway guard lights, configuration B, shall be located across the taxiway at a distance from the runway centre line not less than that specified for a take–off runway in Table 3–2

Characteristics

5.3.20.7 Standard.— Runway guard lights, configuration A, shall consist of two pairs of yellow lights.

5.3.20.8 Standard.— Runway guard lights, configuration B, shall consist of yellow lights spaced at intervals of 3 m across the taxiway.

5.3.20.9 Standard.— The light beam shall be unidirectional and aligned so as to be visible to the pilot of an aircraft taxiing to the holding position.

5.3.20.10 Recommendation.— The intensity in yellow light and beam spreads of lights of configuration A should be in accordance with the specifications in Appendix B, section B.2.6.

5.3.20.11 Recommendation.— The intensity in yellow light and beam spreads of lights of configuration B should be in accordance with the specifications in Appendix B, section B.2.1.

5.3.20.12 Standard.— The lights in each unit of configuration A shall be illuminated alternately.

5.3.20.13 Standard.— For configuration B, adjacent lights shall be alternately illuminated and alternative lights shall be illuminated in unison.

5.3.20.14 Standard.— The lights shall be illuminated between 30 and 60 cycles per minute and the light suppression and illumination periods shall be equal and opposite in each light.

5.3.21 APRON FLOODLIGHTING

(see also 5.3.15.1 And 5.3.16.1)

Application

5.3.21.1 Recommendation.— Apron floodlighting should be provided on an apron, and on a designated isolated aircraft parking position, intended to be used at night.

Note 1.— *The designation of an isolated aircraft parking position is specified in 3.6.7*

Note 2. — *Guidance on apron floodlighting is given in the ICAO Aerodrome Design Manual, Part 4.*

Location

5.3.21.2 Recommendation.— Apron floodlights should be located so as to provide adequate illumination on all apron service areas, with a minimum of glare to pilots of aircraft in flight and on the ground, aerodrome and apron controllers, and personnel on the apron. The arrangement and aiming of floodlights should be such that an aircraft stand receives light from two or more directions to minimize shadows.

Characteristics

5.3.21.3 Standard.— The spectral distribution of apron floodlights shall be such that the colours used for aircraft marking connected with routine servicing, and/or surface and obstacle marking, can be correctly identified.

5.3.21.4 Recommendation.— The average illuminance should be at least the following:

Aircraft stand:

- horizontal illuminance – 20 lux with a uniformity ratio (average to minimum) of not more than 4 to 1; and
- vertical illuminance – 20 lux at a height of 2 m above the apron in relevant directions.

Other apron areas:

- horizontal illuminance – 50 per cent of the average illuminance on the aircraft stands with a uniformity ratio (average to minimum) of not more than 4 to 1.

5.3.22 VISUAL DOCKING GUIDANCE SYSTEM

Application

5.3.22.1 Recommendation.— A visual docking guidance system should be provided when it is intended to indicate, by a visual aid, the precise positioning of an aircraft on an aircraft stand and other alternative means, such as marshalls, are not practicable.

Note.— *The factors to be considered in evaluating the need for a visual docking guidance system are in particular: the number and type(s) of aircraft using the aircraft stand, weather conditions, space available on the apron and the precision required for manoeuvring into the parking position due to aircraft servicing installation, passenger loading bridges, etc. See the ICAO Aerodrome Design Manual, Part 4 for guidance on the selection of suitable systems.*

5.3.22.2 Standard.— The provisions of paragraphs 5.3.22.3 to 5.3.22.7, 5.3.22.9 to 5.3.22.12 and 5.3.22.16 and 5.3.22.18 shall not require the replacement of existing installations before January 01, 2005.

Characteristics

5.3.22.3 Standard.— The system shall provide both azimuth and stopping guidance.

5.3.22.4 Standard.— The azimuth guidance unit and the stopping position indicator

shall be adequate for use in all weather, visibility, background lighting, and pavement conditions for which the system is intended both by day and night, but shall not dazzle the pilot.

Note.— *Care is required in both the design and on-site installation of the system to ensure that reflection of sunlight, or other light in the vicinity, does not degrade the clarity and conspicuity of the visual cues provided by the system.*

5.3.22.5 Standard.— The azimuth guidance unit and the stopping position indicator shall be of a design such that:

- a) a clear indication of malfunction of either or both is available to the pilot; and
- b) they can be turned off.

5.3.22.6 Standard.— The azimuth guidance unit and the stopping position indicator shall be located in such a way that there is continuity of guidance between the aircraft stand markings, the aircraft stand manoeuvring guidance lights, if present, and the visual docking guidance system.

5.3.22.7 Standard.— The accuracy of the system shall be adequate for the type of loading bridge and fixed aircraft servicing installations with which it is to be used.

5.3.22.8 Recommendation.— The system should be usable by all types of aircraft for which the aircraft stand is intended, preferably without selective operation.

5.3.22.9 Standard.— If selective operation is required to prepare the system for use by a particular type of aircraft, then the system shall provide an identification of the selected aircraft type to both the pilot and the system operator as a means of ensuring that the system has been set properly.

AZIMUTH GUIDANCE UNIT

Location

5.3.22.10 Standard.— The azimuth guidance unit shall be located on or close to the extension of the stand centre line ahead of the

aircraft so that its signals are visible from the cockpit of an aircraft throughout the docking manoeuvre and aligned for use by the pilot occupying the left seat.

Characteristics

5.3.22.11 Standard.— The azimuth guidance unit shall provide unambiguous left/right guidance which enables the pilot to acquire and maintain the lead-in line without over-controlling.

5.3.22.12 Standard.— When azimuth guidance is indicated by colour change, green shall be used to identify the centre line and red for deviations from the centre line.

STOPPING POSITION INDICATOR

Location

5.3.22.13 Recommendation.— The stopping position indicator should be located in conjunction with, or sufficiently close to the azimuth guidance unit so that a pilot can observe both the azimuth and stop signals without turning the head.

5.3.22.14 Standard.— The stopping position indicator shall be usable at least by the pilot occupying the left seat.

Characteristics

5.3.22.15 Standard.— The stopping position information provided by the indicator for a particular aircraft type shall account for the anticipated range of variations in pilot eye height and/or viewing angle.

5.3.22.16 Standard.— The stopping position indicator shall show the stopping position for the aircraft for which guidance is being provided, and shall provide closing rate information to enable the pilot to gradually decelerate the aircraft to a full stop at the intended stopping position .

5.3.22.17 Recommendation.— The stopping position indicator should provide closing rate information over a distance of at least 10 m.

5.3.22.18 Standard.— When stopping guidance is indicated by colour change, green

shall be used to show that the aircraft can proceed and red to show that the stop point has been reached except that for a short distance prior to the stop point a third colour may be used to warn that the stopping point is close.

5.3.23 AIRCRAFT STAND MANOEUVRING GUIDANCE LIGHTS

Application

5.3.23.1 Recommendation.— Aircraft stand manoeuvring guidance lights should be provided to facilitate the positioning of an aircraft on an aircraft stand intended for use in poor visibility conditions unless adequate guidance is provided by other means.

Location

5.3.23.2 Standard.— Aircraft stand manoeuvring guidance lights shall be collocated with the aircraft stand markings, except that the lights may be uniformly offset by not more than 30 cm where it is not practical to locate them along the centreline.

Characteristics

5.3.23.3 Standard.— Aircraft stand manoeuvring guidance lights, other than those indicating a stop position shall be fixed yellow lights, visible throughout the segments within which they are intended to provide guidance.

5.3.23.4 Recommendation.— The lights used to delineate lead-in, turning and lead-out lines should be spaced at intervals of not more than 7.5 m on curves and 15 m on straight sections.

5.3.23.5 Standard.— The lights indicating a stop position shall be fixed, unidirectional lights, showing red.

5.3.23.6 Recommendation.— The intensity of the lights should be adequate for the condition of visibility and ambient light in which the use of the aircraft stand is intended.

5.3.23.7 Recommendation.— The lighting circuit should be designed so that the lights may be switched on to indicate that an aircraft stand is

to be used and switched off to indicate that it is not to be used.

5.3.24 ROAD-HOLDING POSITION LIGHT (see also 5.3.18 and 5.3.20)

Application

5.3.24.1 Standard.— A road-holding position light shall be provided at each road-holding position serving a runway when it is intended that the runway will be used in runway visual range conditions less than a value of the order of 1400 ft (400 m).

5.3.24.2 Recommendation.— A road-holding position light should be provided at each road-holding position serving a runway when it is intended that the runway will be used in runway visual range conditions of values between the order of 1400 ft (400 m) and 2600 ft (800 m).

Location

5.3.24.3 Standard.— A road-holding position light shall be located adjacent to the holding position marking 1.5 m from the right hand edge of the road.

Note.— See 8.6.2 to 8.6.4 for the mass and height limitations and frangibility requirements of navigational aids located on runway strips.

Characteristics

5.3.24.4 Standard.— The road-holding position light shall comprise:

- a) a controllable red (stop)/green (go) traffic light; or
- b) a flashing red light.

5.3.24.5 Standard.— The road-holding position light beam shall be unidirectional and aligned so as to be visible to the driver of a vehicle approaching the holding position.

5.3.24.6 Standard.— The intensity of the light beam shall be adequate for the conditions of visibility and ambient light in which the use of the holding position is intended, but shall not dazzle the driver.

Note.— The commonly used traffic lights are likely to meet the requirements in 5.3.24.5 and 5.3.24.6.

5.3.24.7 Standard.— The flash frequency of flashing red light shall be between 30 and 60 per minute with the lamp illuminated approximately 50 per cent of the time.

5.4 SIGNS

5.4.1 GENERAL

Note 1.— Signs that convey instructions or information to a pilot are an essential component of the visual aids system at aerodromes. A sign provides a visual message by virtue of its situation, shape, colour, or pattern and by the use of symbols and alphanumeric characters. A sign therefore needs to be conspicuous, legible, comprehensible and credible.

Note 2.— It is intended that existing signs not conforming to the specifications in 5.4 be replaced no later than January 1, 1997. Until that date existing signs will be alternatives to the conforming specifications. Consequently, and taking into account the average service life of signs, it is considered that henceforth aerodrome operators may wish to install new signs conforming to the specifications contained in 5.4. Thus, specifications for signs installed in accordance with the provisions contained in previous editions of TP 312 are not provided. Aerodrome operators with non conforming signs are encouraged to develop a systematic sign replacement program that will minimize the transition period to lessen, to the extent possible, confusion for pilots and vehicle operators.

Application

5.4.1.1 Standard.— Signs shall be provided to convey, a mandatory instruction, information on a specific location or destination on a movement area or to provide other information to meet the requirements of section 8.8 (*Surface Movement Guidance and Control System*).

Note 1.— Where an information sign would normally be installed and it is physically impossible to install a sign an information marking may be

displayed on the surface of the pavement.

Note 2.— See 5.2.16 for specifications on information marking.

Characteristics

5.4.1.2 Standard.— Signs shall be frangible. Those located near a runway or taxiway shall be sufficiently low to preserve clearance for propellers and the engine pods of jet aircraft.

5.4.1.3 Standard.— Signs shall be rectangular, with the longer side horizontal.

5.4.1.4 Standard.— The only signs on the movement area utilizing red shall be mandatory instruction signs.

5.4.1.5 Standard.— The inscriptions on a sign shall be in accordance with Table 5-8 and Appendix C.

5.4.1.6 Standard.— Where signs of differing minimum character heights are located together to form an array, the signs shall be of uniform dimensions, conforming to the larger of the character heights (eg. location sign collocated with a runway designation sign).

5.4.1.7 Standard.— Signs shall be illuminated, when intended for use:

- a) in conditions of visibility in the order of 400 m or less; or
- b) at night in association with instrument runways; or
- c) at night in association with non-instrument runways where the code number is 3 or 4.

5.4.1.8 Standard.— Signs shall be retro-reflective and/or illuminated when intended for use at night in association with non-instrument

Table 5-8 Sign Sizes and Installation Criteria

	MANDATORY INSTRUCTION SIGN		INFORMATION SIGNS			
			Runway exit		Location, Direction, Destination, etc	
	(1)		(2)		(3)	
	Code number		Code number		Code number	
1 and 2	3 and 4	1 and 2	3 and 4	1 and 2	3 and 4	
Vertical Dimensions:						
Minimum character ht.	300 mm	400 mm	300 mm	400 mm	200 mm	400 mm
Minimum face ht.	450 mm	600 mm	450 mm	600 mm	300 mm	600 mm
Desired face ht.	600 mm	800 mm	600 mm	800 mm	400 mm	800 mm
Installation Criteria:						
Minimum installed ht.	105 cm	120 cm	105 cm	120 cm	90 cm	120 cm
Maximum installed ht.	180 cm	200 cm	180 cm	200 cm	160 cm	200 cm
Perpendicular distance from defined taxiway edge to near side of sign	5-11 m	11-21 m	5-11 m	11-21 m	5-11 m	11-21 m
Perpendicular distance from defined runway edge to near side of sign	3-11 m	8-21 m	3-11 m	8-21 m	3-11 m	8-21 m
<i>Note 1.— The black vertical delineator between adjacent direction signs should have a width of approximately 0.7 of the stroke width.</i>						
<i>Note 2.— The border on a location sign should be approximately 0.5 stroke width.</i>						

runways where the code number is 1 or 2.

5.4.1.9 Recommendation.— Signs provided in accordance with 5.4.1.7 should also be retro-reflective.

5.4.1.10 Standard.— A sign illuminated in accordance with 5.4.1.7 and 5.4.1.8 shall be visible over a distance of at least 250 m and legible at a distance of 180 m on a clear night.

5.4.1.11 Standard.— Signs intended for use in conditions of visibility in the order of 400 m or less shall be illuminated so as to be visible over a distance of 250 m and legible at a distance 180 m when the RVR is 1400 ft (400 m) or greater.

5.4.1.12 Standard.— The luminance values shall be uniform over the face of internally and externally illuminated signs.

5.4.1.13 Standard.— The characters on a sign lighted using imbedded fiberoptic elements shall be illuminated such that:

- a) the characters on mandatory instruction signs shall show red;
- b) the characters on information signs shall show white except that the characters on a location sign shall show yellow;
- c) the sign shall be legible when viewed from angles up to 80° from the optical axis; and
- d) a single lamp failure shall not result in the character or any portion of the character being extinguished.

5.4.2 MANDATORY INSTRUCTION SIGNS

Note.— See Table 5-9 for pictorial representation of mandatory instruction signs and Figure 5-22 for examples of locating signs at taxiway/runway intersections.

Application

5.4.2.1 Standard.— A mandatory instruction sign shall be provided to identify a location beyond which an aircraft taxiing or vehicle shall not proceed unless:

- a) authorized by the aerodrome control tower where provided; or
- b) the pilot or vehicle operator has verified that the runway is clear.

5.4.2.2 Standard.— Mandatory instruction signs shall include:

- a) runway designation signs;
- b) Category I, Category II, Category III or Category II/III holding position signs; and
- c) no entry signs.

Note.— See 5.4.7 for specifications on road-hold position signs.

5.4.2.3 Standard.— A pattern "A" taxi-holding position marking shall be supplemented with a runway designation sign.

5.4.2.4 Standard.— A pattern "B" taxi-holding position marking shall be supplemented with a Category I, Category II, Category III or Category II/III holding position sign.

Note.— See 5.2.9 for taxi holding position marking.

5.4.2.5 Standard.— A runway designation sign at a taxiway/runway intersection shall be supplemented with a location sign in the outboard (furthest from the taxiway) position.

Note.— See 5.4.3 for characteristics of location signs.

5.4.2.6 Standard.— A no entry sign shall be provided when entry into an area is prohibited.

Location

5.4.2.7 Standard.— A runway designation sign at a taxiway/runway intersection shall face the direction of approach to the runway and be located:

- a) on each side of a taxiway associated with a precision approach runway;
- b) on each side of a taxiway where the taxiway width (including where appropriate, a holding bay) is 45 m or greater; and

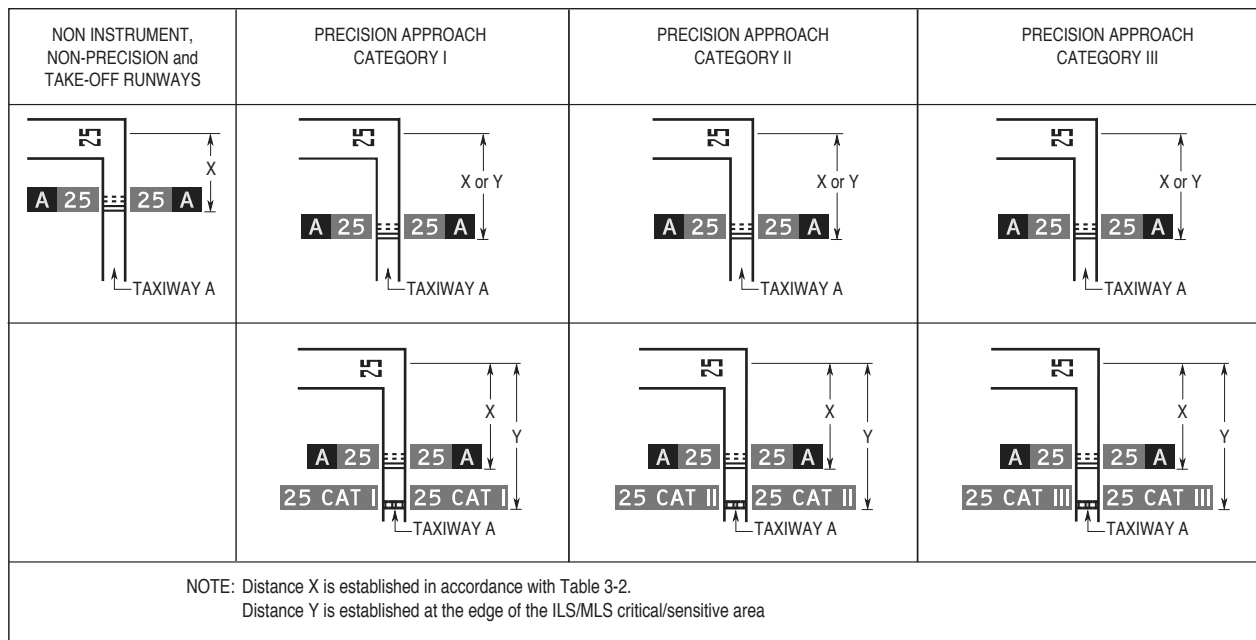

Figure 5-22. Examples of locating mandatory instruction signs at taxiway/runway intersections

- c) at least on the left side of a taxiway associated with a non-precision or non-instrument runway. Where practicable a runway designation sign should be located on each side of the taxiway.

5.4.2.8 Standard.— A runway designation sign at a runway/ runway intersection shall be located on each side of the runway except where an aeronautical study indicates one sign would be adequate.

5.4.2.9 Standard.— A Category II, Category III or Category II/III holding position sign shall be located on each side of the holding position marking facing the direction of approach to the critical area.

5.4.2.10 Standard.— A no entry sign shall be located at the beginning of the area to which entrance is prohibited at least on the left hand side of the taxiway as viewed by the pilot. Where practicable, a no entry sign shall be located on each side of the taxiway.

5.4.2.11 Standard.— Mandatory instruction signs shall be located at a perpendicular distance from the taxiway or runway in accordance with Table 5-8.

Characteristics

5.4.2.12 Standard.— A mandatory instruction sign shall consist of an inscription in white on a red background.

5.4.2.13 Standard.— The inscription on a runway designation sign shall consist of the runway designation of the intersecting runway properly oriented with respect to the viewing position of the sign, except that a runway designation sign installed in the vicinity of a runway extremity may show the runway designation of the concerned runway extremity only. In cases of airports located within the area of compass unreliability, the inscription on a runway designation sign shall consist of the exact runway azimuth as a three-digit number in degrees TRUE, properly oriented with respect to the viewing position of the sign (i.e., 258T - 078T).

5.4.2.14 Standard.— The inscription on a Category II or III holding position sign shall consist of the runway designator of the runway for which the holding position is established followed by the CAT II, CAT III or CAT II/III designation as appropriate.

5.4.2.15 Standard.— The inscription on a no entry sign shall be in accordance with Table 5-9 and Appendix C.

5.4.2.16 Standard.— Where appropriate, the inscriptions/symbols depicted in Table 5-9 shall be used.

5.4.3 INFORMATION SIGNS

Note.— See Figure 5-23 for pictorial representations of information signs.

Application

5.4.3.1 Standard.— An information sign

shall be provided where there is an operational need to identify by a sign, a specific location, or routing information.







5.4.3.2 Standard.— Information signs shall include direction signs, location signs, destination signs, and runway exit signs.

5.4.3.3 Standard.— A runway exit sign shall be provided at all taxiway exits from runways except that signs may be omitted:

- where entry to the taxiway is not permitted; or
- where aircraft exiting the runway do not normally proceed in that direction.

5.4.3.4 Recommendation.— Where necessary, a destination sign should be provided to indicate the direction of a specific destination on the aerodrome, such as cargo area, general aviation, etc.

Table 5-9. Information to be displayed on Mandatory Instruction Signs

SYMBOL/INSCRIPTION	EXAMPLE	USE
Runway designation of a runway extremity		To indicate a taxi-holding position at a runway extremity
Runway designation of both extremities of a runway		To indicate a taxi-holding position located at other than a runway extremity
ILS/MLS Category I hold position		To indicate a Category I taxi-holding position at the threshold of a runway (example.— Rwy 25)
ILS/MLS Category II hold position		To indicate a Category II taxi-holding position at the threshold of a runway (example.— Rwy 25)
ILS/MLS Category III hold position		To indicate a Category III taxi-holding position at the threshold of a runway (example.— Rwy 25)
ILS/MLS Category II and III hold Position		To indicate a joint Category II/III taxi-holding position at the threshold of a runway (example.— Rwy 25)
No Entry		To indicate that entry to an area is prohibited

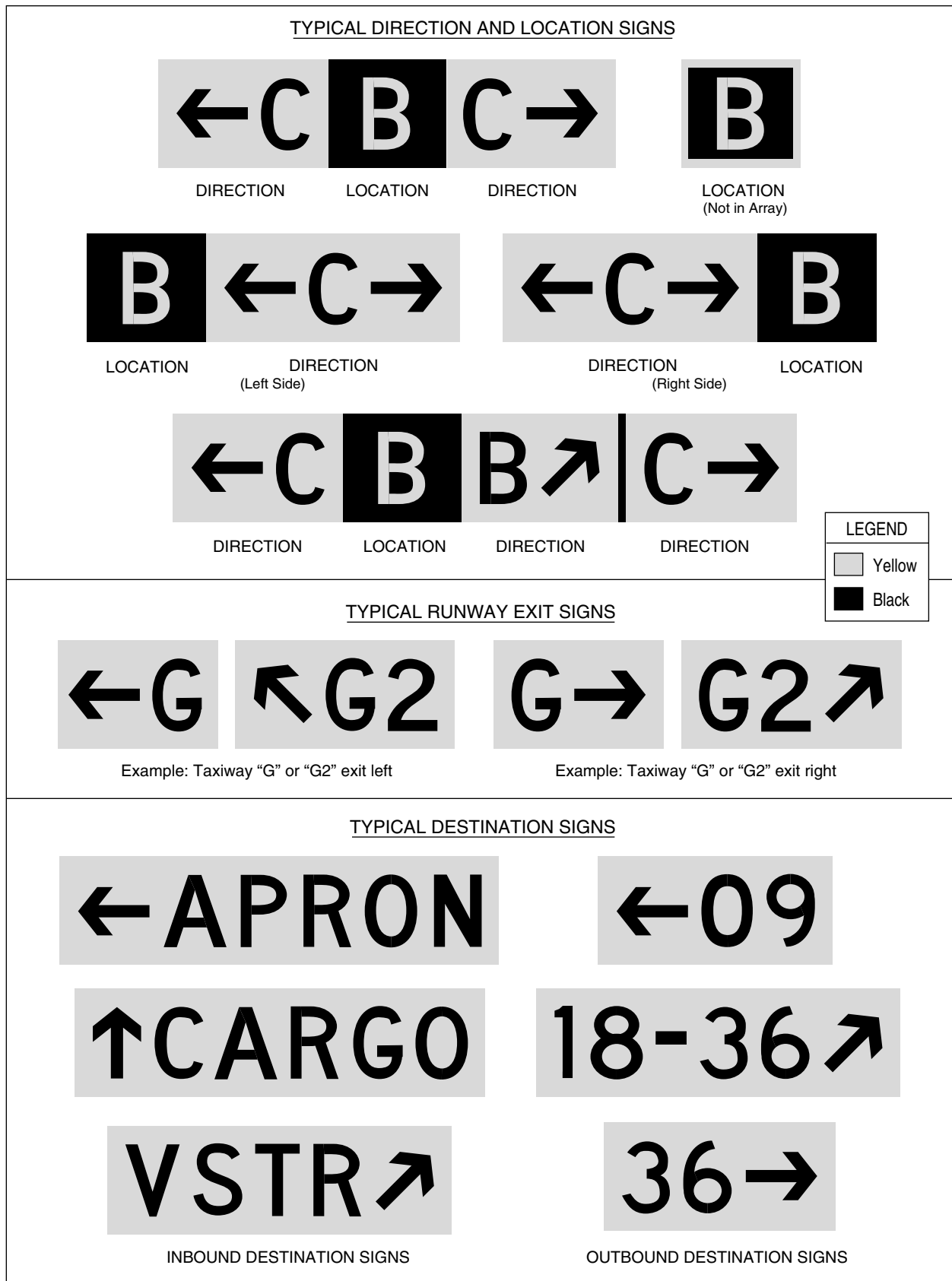
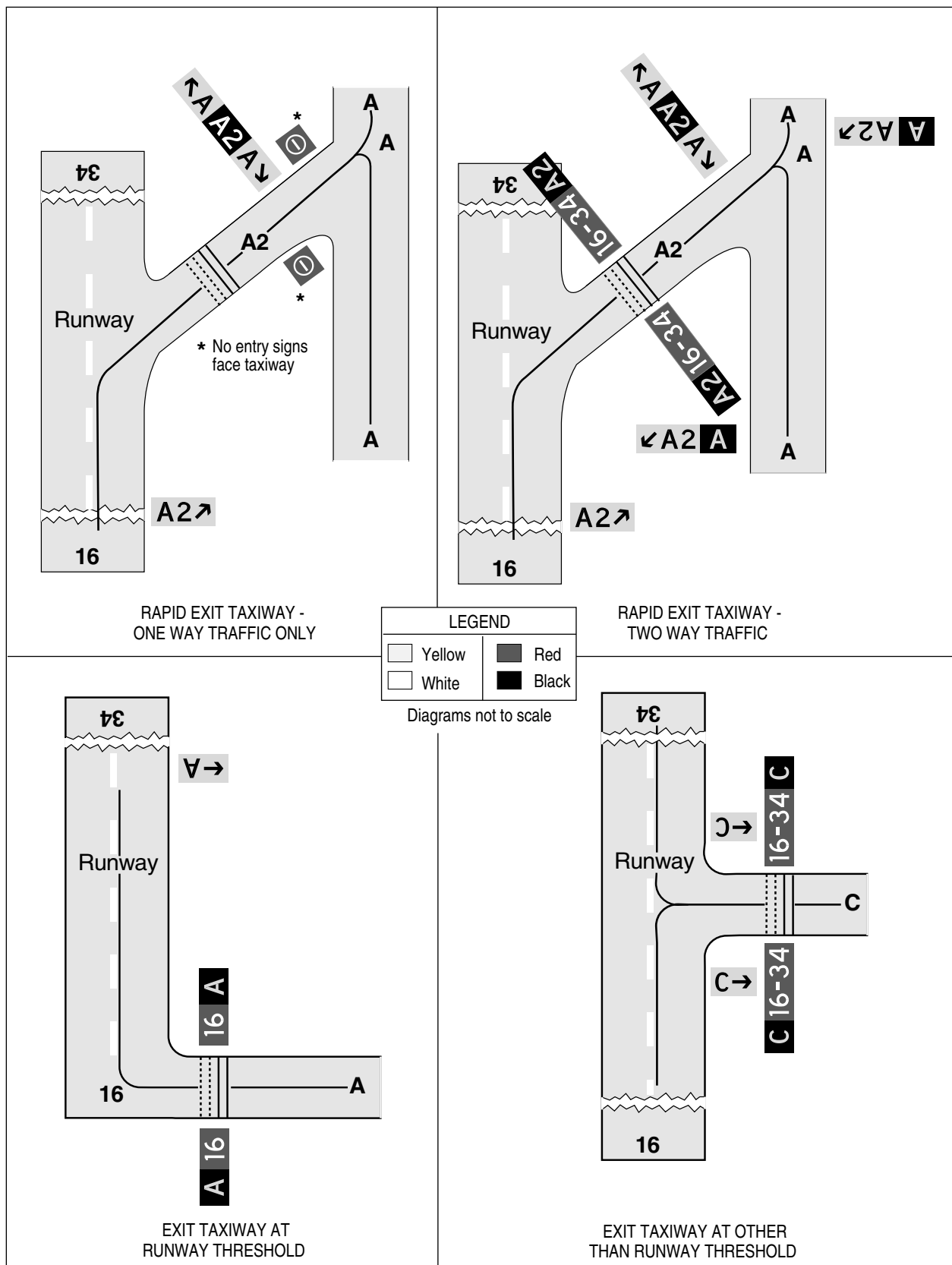

Figure 5-23. Examples of information signs



5.4.3.5 Standard.— A combined location and direction sign shall be provided when it is intended to indicate routing information prior to a taxiway intersection.

5.4.3.6 Standard.— A direction sign shall be provided when there is an operational need to identify the designation and direction of taxiways at an intersection.

5.4.3.7 Standard.— A location sign shall be provided in conjunction with a direction sign or a runway designation sign located at a taxiing/runway intersection except that it may be omitted where an aeronautical study indicates that it is not needed.

5.4.3.8 Recommendation.— Where necessary, a location sign should be provided to identify taxiways exiting an apron or to identify taxiways beyond an intersection.

5.4.3.9 Recommendation.— Where a taxiway ends at an intersection such as a “T” and it is necessary to identify this, a direction sign and/or other appropriate visual aid should be used.

Location

5.4.3.10 Standard.— Except as specified in para 5.4.3.12 and 5.4.3.17, information signs shall, wherever practicable, be located on the left-hand side of the taxiway in accordance with Table 5-9.

5.4.3.11 Standard.— At a taxiway intersection, information signs shall be located prior to the intersection and in line with the taxiway intersection marking. Where there is no taxiway intersection marking, the signs shall be installed at least 60 m from the centre line of the intersecting taxiway where the code number is 3 or 4 and at least 40 m where the code number is 1 or 2.

Note.— A taxiway location sign installed beyond a taxiway intersection may be located on either side of the taxiway.

5.4.3.12 Standard.— A runway exit sign shall be located on the same side of the runway (left or right) as the exit and positioned in accordance with Table 5-8.

5.4.3.13 Standard.— A runway exit sign shall be located prior to the runway exit point in line

with a position at least 60 m prior to the point of tangency where the code number is 3 or 4, and at least 30 m where the code number is 1 or 2.

5.4.3.14 Standard.— A taxiway location sign installed in conjunction with a runway designation sign shall be positioned outboard of the runway designation sign.

5.4.3.15 Recommendation.— A destination sign should not normally be collocated with a location or direction sign.

5.4.3.16 Standard.— An information sign other than a location sign shall not be collocated with a mandatory instruction sign.

5.4.3.17 Recommendation.— A direction sign or other appropriate visual aid used to identify a “T” intersection should be located on the opposite side of the intersection facing the taxiway.

Characteristics

5.4.3.18 Standard.— An information sign shall consist of an inscription in black on a yellow background except that a location sign shall consist of an inscription in yellow on a black background.

5.4.3.19 Standard.— The inscription on a runway exit sign shall consist of the designator of the exit taxiway and an arrow indicating the direction to follow.

5.4.3.20 Standard.— The inscription on a destination sign shall comprise an alpha, alpha numeric or numeric message identifying the destination plus an arrow indicating the direction to proceed.

5.4.3.21 Standard.— The inscriptions on a direction sign shall comprise an alpha or alpha/numeric message identifying the route plus an arrow or arrows appropriately oriented.

5.4.3.22 Standard.— The inscription on a location sign shall comprise the designation of the location, taxiway, or other pavement the aircraft is on or is entering and shall not contain arrows.

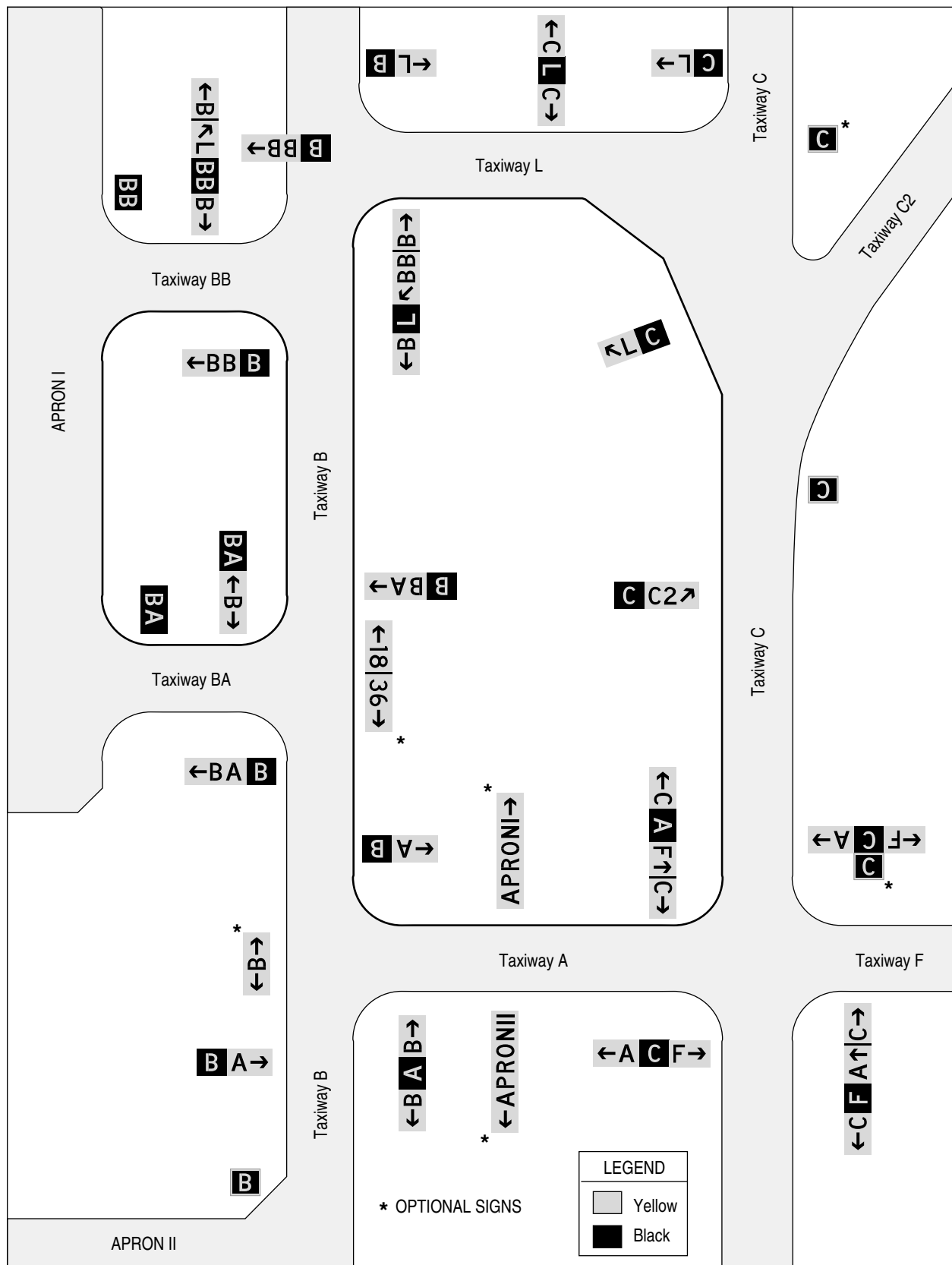

Figure 5-25. Examples of locating information signs

5.4.3.23 Standard.— Where a location sign and direction signs are used in combination to provide routing guidance:

- a) all direction signs related to left turns shall be located to the left of the location sign and all direction signs related to right turns shall be located to the right of the location sign except that where the junction consists of one intersecting taxiway, the location sign may alternatively be placed in the outboard position;
- b) the direction signs shall be placed such that the direction of the arrows departs increasingly from the vertical with increasing deviation of the corresponding taxiway;
- c) an appropriate direction sign shall be placed next to the location sign where the direction of the location taxiway changes more than 25° beyond the intersection; and
- d) adjacent direction signs shall be delineated by a vertical black line as shown in Figure 5-23.

Note.— See Figure 5-23 for examples of location/direction signs used in combination.

5.4.3.24 Standard.— A taxiway shall be identified by a designator comprising a letter, letters or a combination of letters followed by a number.

5.4.3.25 Recommendation.— When designating taxiways, the use of the letters I, O and X and the use of such words as inner and outer for the designation of taxiways should be avoided whenever possible to avoid confusion with the numerals 1 (one), 0 (zero) and closed markings.

5.4.3.26 Standard.— Rapid exit taxiways shall use an alpha/numeric system, i.e., A1, A2, etc., identified with the taxiway to which they are connected. The numeric portion of the coding shall be odd numbers for exits serving easterly runways (01 to 18) and even numbers for westerly runways (19 to 36).

5.4.3.27 Standard.— Where required, apron areas shall be identified with signs having Roman numerals.

5.4.3.28 Recommendation.— Apron exits from taxiways should be identified with the taxiway to which they are connected and use an alpha/alpha system (i.e. AA, AB, etc.) The first letter represents the associated taxiway, the second the apron exit and should be lettered sequentially.

Note.— Taxiways leading to privately owned aprons and/or hangars need not be identified unless a requirement exists for public use.

5.4.3.29 Standard.— The use of numbers alone on the manoeuvring area shall be reserved for the designation of runways

5.4.4 MANDATORY FREQUENCY/ AERODROME TRAFFIC FREQUENCY SIGNS

Note 1.— The inclusion of detailed specifications for Mandatory Frequency (MF) or Aerodrome Traffic Frequency (ATF) signs in this section does not imply that MF or ATF signs are required to be provided.

Note 2.— At airports which are uncontrolled or where air traffic services have limited hours of operation, a sign indicating the MF or ATF frequency may be provided.

Location

5.4.4.1 Recommendation.— An MF/ATF sign should face the direction of approach to the runway and be located at least on one side of a taxiway at a point not closer to the runway than the taxi holding position marking.

5.4.4.2 Standard.— An MF/ATF sign shall not be collocated with a runway designation sign.

5.4.4.3 Recommendation.— Where a runway designation sign is provided on one side of the taxiway only, the MF/ATF sign should be located on the opposite side of the taxiway in line with the taxiway holding position marking.

5.4.4.4 Recommendation.— Where runway designation signs are located on both sides of the taxiway, the MF/ATF sign should be positioned prior to the runway designation sign and be located such that the runway designation sign is not obscured.

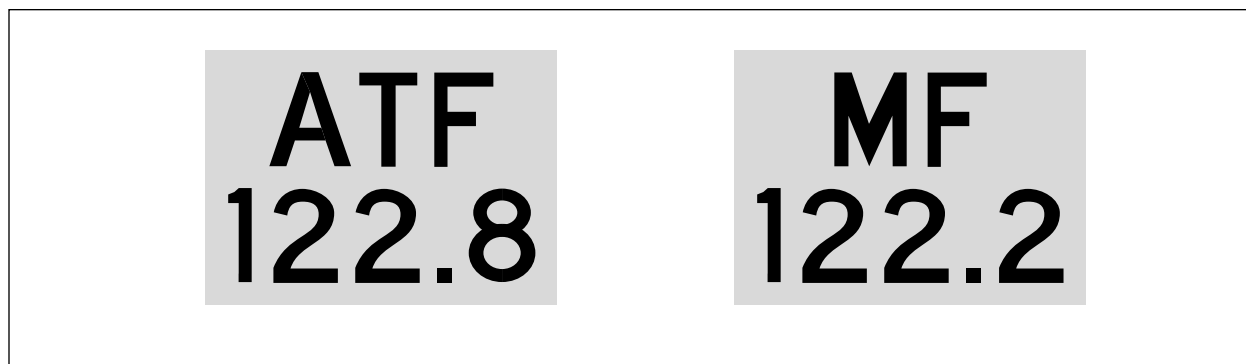

Figure 5-26. Examples of mandatory frequency (MF) and aerodrome traffic frequency (ATF) signs

Note.— At airports with simple apron/taxiway configurations, a sign located at the point where the apron connects to the taxiway has been found to be suitable.

Characteristics

5.4.4.5 Standard.— An MF/ATF sign shall consist of an inscription in black on a yellow background.

5.4.4.6 Standard.— The inscription on an MF or ATF sign shall be in accordance with Figure 5-26 and Appendix C.

5.4.5 AERODROME IDENTIFICATION SIGN

Application

5.4.5.1 Recommendation.— An aerodrome identification sign should be provided at an aerodrome where there is insufficient alternative means of visual identification.

Location

5.4.5.2 Recommendation.— The aerodrome identification sign should be placed on the aerodrome so as to be legible in so far as is practicable, at all angles above the horizontal.

Characteristics

5.4.5.3 Standard.— The aerodrome identification sign shall consist of the name of the aerodrome.

5.4.5.4 Recommendation.— The colour selected for the sign should give adequate conspicuity when viewed against its background.

5.4.5.5 Recommendation.— The characters should have a height of not less than 3 m.

5.4.6 AIRCRAFT STAND IDENTIFICATION SIGNS

Application

5.4.6.1 Recommendation.— An aircraft stand identification marking should be supplemented with an aircraft stand identification sign where feasible.

Location

5.4.6.2 Recommendation.— An aircraft stand identification sign should be located so as to be clearly visible from the cockpit of an aircraft prior to entering the aircraft stand.

Characteristics

5.4.6.3 Standard.— An aircraft stand identification sign shall consist of an inscription in black on a yellow background.

5.4.7 ROAD-HOLDING POSITION SIGN

Application

5.4.7.1 Standard.— A road-holding position sign shall be provided at all road entrances

to a runway.

Note.— See 5.2.14 for specification on road-hold position marking.

Location

5.4.7.2 Standard.— The road-holding position sign shall be located 1.5 m from the right-hand edge of the road at the holding position.

Characteristics

5.4.7.3 Standard.— The inscriptions on a road-holding position sign shall be in the local language(s) and shall include the following:

- a) a requirement to stop. This shall be in conformity with the local traffic convention;
- b) a requirement to obtain ATC clearance to cross the runway; and
- c) location designator.

5.4.7.4 Standard.— A road-holding position sign intended for night use shall be retro-reflective or illuminated.

5.5 MARKERS

5.5.1 GENERAL

5.5.1.1 Standard.— Markers shall be light-weight and frangibly mounted. Those located near a runway or taxiway shall be sufficiently low to preserve clearance for propellers and for the engine pods of jet aircraft.

Note 1.— *Anchors or chains, to prevent markers which have broken from their mounting from blowing away, are sometimes used.*

Note 2.— *Guidance on frangibility of markers is given in the Aerodrome Design Manual, Part 4.*

5.5.2 UNPAVED RUNWAY EDGE MARKERS

Application

5.5.2.1 Recommendation.— Markers should be provided when the extent of an unpaved runway is not clearly indicated by the appearance of its surface compared with that of the surrounding ground.

Location

5.5.2.2 Recommendation.— Where runway lights are provided, the markers should be incorporated in the light fixtures. Where there are no lights, markers of flat rectangular or conical shape should be placed so as to delimit the runway clearly.

Characteristics

5.5.2.3 Recommendation.— The flat rectangular markers should have a minimum size of 1 m by 3 m and should be placed with their long dimension parallel to the runway centre line. The conical markers should have a height not exceeding 50 cm.

5.5.3 STOPWAY EDGE MARKERS

Application

5.5.3.1 Recommendation.— Stopway edge markers should be provided when the extent of a stopway is not clearly indicated by its appearance compared with that of the surrounding ground.

Characteristics

5.5.3.2 Standard.— The stopway edge markers shall be sufficiently different from any runway edge markers used to ensure that the two types of markers cannot be confused.

Note.— *Markers consisting of small vertical boards camouflaged on the reverse side, as viewed from the runway, have proved operationally acceptable.*

5.5.4 EDGE MARKERS FOR SNOW-COVERED RUNWAYS

Application

5.5.4.1 Recommendation.— Edge markers for snow covered runways should be used to indicate the usable limits of a snow-covered runway when the limits are not otherwise indicated.

Note.— *Runway lights could be used to indicate the limits.*

Location

5.5.4.2 Recommendation.— Edge markers for snow-covered runways should be placed along the sides of the runway at intervals of not more than 100 m, and should be located symmetrically about the runway centre line at such a distance from the centre line that there is adequate clearance for wing tips and power plants. Sufficient markers should be placed across the threshold and end of the runway.

5.5.5 TAXIWAY EDGE MARKERS

Application

5.5.5.1 Recommendation.— Taxiway edge markers should be provided on a taxiway where the code number is 1 or 2 and taxiway centre line or edge lights or taxiway centre line markers are not provided.

Location

5.5.5.2 Recommendation.— Taxiway edge markers should be installed at least at the same locations as would the taxiway edge lights had they been used.

Characteristics

5.5.5.3 Standard.— A taxiway edge marker shall be retro-reflective blue.

5.5.5.4 Recommendation.— The marked surface as viewed by the pilot should be a rectangle and should have a minimum viewing area of 150 cm².

5.5.5.5 Standard.— Taxiway edge markers shall be light weight and frangible. Their height shall be sufficiently low to preserve clearance for propellers and for the engine pods of jet aircraft.

5.5.6 TAXIWAY CENTRE LINE MARKERS

Application

5.5.6.1 Recommendation.— Taxiway centre line markers should be provided on a taxiway where the code number is 1 or 2 and taxiway centre line or edge lights or taxiway edge markers are not provided.

5.5.6.2 Recommendation.— Taxiway centre line markers should be provided on a taxiway where the code number is 3 or 4 and taxiway centre lights are not provided if there is a need to improve the guidance provided by the taxiway centre line marking.

Location

5.5.6.3 Recommendation.— Taxiway centre line markers should be installed at least at the same location as would taxiway centre line lights had they been used.

Note.— *See 5.3.16 for the spacing of taxiway centre line lights.*

5.5.6.4 Recommendation.— Taxiway centre line markers should normally be located on the taxiway centre line marking except that they may be offset by not more than 30 cm where it is not practicable to locate them on the marking.

Characteristics

5.5.6.5 Standard.— A taxiway centre line marker shall be retro-reflective green.

5.5.6.6 Recommendation.— The marked surface as viewed by the pilot should be a rectangle and have a minimum viewing area of 20 cm².

5.5.6.7 Standard.— Taxiway centre line markers shall be so designed and fitted as to withstand being run over by the wheels of an aircraft without damage either to the aircraft or to

the markers themselves.

5.5.7 UNPAVED TAXIWAY EDGE MARKERS

Application

5.5.7.1 Recommendation.— Where the extent of an unpaved taxiway is not clearly indicated by its appearance compared with that of the surrounding ground, markers should be provided.

Location

5.5.7.2 Recommendation.— Where taxiway lights are provided, the markers should be incorporated in the light fixtures. Where there are no lights, markers of conical shape should be placed so as to delimit the taxiway clearly.

5.5.8 BOUNDARY MARKERS

Application

5.5.8.1 Standard.— Boundary markers shall be provided at an aerodrome where the landing area has no runway.

Location

5.5.8.2 Standard.— Boundary markers shall be spaced along the boundary of the landing area at intervals of not more than 200 m, if a pyramid type is used, or approximately 90 m, if a conical type is used, with a marker at any corner.

Characteristics

5.5.8.3 Recommendation.— Boundary markers should be of a conical or elongated pyramid form. The pyramid form markers should be approximately 3 m long, 0.5 m high, and 1 m across the base. Conical markers should be approximately 90 cm diameter across the base and approximately 75 cm high.

5.5.8.4 Recommendation.— Boundary markers should be coloured to contrast with the background against which they will be seen. A single colour, orange or red, or two contrasting colours, orange and white or alternatively red and white, should be used, except where such colours merge with the background.

CHAPTER 6. VISUAL AIDS FOR DENOTING OBSTACLES

6.1 OBJECTS TO BE MARKED AND/OR LIGHTED

Note 1.— The marking and/or lighting of obstacles is intended to reduce hazards to aircraft by indicating the presence of the obstacles. It does not necessarily reduce operating limitations which may be imposed by an obstacle.

Note 2.— The requirements of this chapter are intended to be applied to objects located within the perimeter of the aerodrome and immediate vicinity. The requirements to mark and light other objects may be found in the Transport Canada publication, TP 382E, Standard Obstruction Markings Manual.

6.1.1 OBJECTS ON MOVEMENT AREAS

6.1.1.1 Standard.— Vehicles and other mobile objects, excluding aircraft, on the manoeuvring area of an aerodrome are obstacles and shall be marked and, if the vehicle and aerodrome are used at night or in conditions of low visibility, lighted.

6.1.1.2 Recommendation.— Vehicles and other mobile objects, excluding aircraft, used on an apron should be marked and, if the vehicle and aerodrome are used at night or in conditions of low visibility, lighted.

6.1.1.3 Standard.— Elevated aeronautical ground lights within the movement area shall be marked so as to be conspicuous by day.

6.1.2 OBJECTS ON RUNWAY STRIPS

6.1.2.1 Standard.— A fixed object located on a runway strip shall be marked and if the aerodrome is used at night, lighted, excluding visual aids that are by their nature visually conspicuous

6.1.3 OTHER OBJECTS

6.1.3.1 Recommendation.— A fixed obstacle that extends above a take-off/approach surface within 3000 m of the inner edge should be marked and, if the runway is used at night, lighted except that:

- a) such marking and lighting may be omitted when the obstacle is shielded by another fixed obstacle;
- b) the marking may be omitted when the height of the obstacle above the level of the surrounding ground does not exceed 150 m and it is lighted by medium intensity obstacle light by day;
- c) the marking may be omitted when the obstacle is lighted by high intensity obstacle lights by day and;
- d) the lighting may be omitted where the obstacle is a lighthouse and an aeronautical study indicates the lighthouse light to be sufficient.

6.1.3.2 Recommendation.— A fixed object, other than an obstacle, adjacent to a take-off/approach surface should be marked and if the runway is used at night, lighted if such marking and lighting is considered necessary to ensure its avoidance except that the marking may be omitted when:

- a) the height of the obstacle above the level of the surrounding ground does not exceed 150 m and it is lighted by medium intensity obstacle light by day; or
- b) the object is lighted by high-intensity obstacle lights by day.

6.1.3.3 Recommendation.— A fixed obstacle that extends above an outer surface should be marked and if the aerodrome is used at night lighted except that:

- a) such marking and lighting may be omitted when:

- i) the obstacle is shielded by another fixed obstacle; or
 - ii) for a circuit extensively obstructed by immovable objects or terrain, procedures have been established to ensure safe vertical clearance below prescribed flight paths; or
 - iii) an aeronautical study shows the obstacle not to be of operational significance;
- b) the marking may be omitted when the height of the obstacle above the level of the surrounding ground does not exceed 150 m and it is lighted by medium intensity obstacle light by day;
 - c) the marking may be omitted when the obstacle is lighted by high-intensity obstacle lights by day; and
 - d) the lighting may be omitted where the obstacle is a lighthouse and an aeronautical study indicates the lighthouse light to be sufficient.

6.1.3.4 Standard.— A fixed object that extends above an obstacle protection surface shall be marked and, if the runway is used at night, lighted.

6.1.3.5 Standard.— All elevated objects within the distance specified in Table 3–1, column 5 from the centre line of a taxiway or an apron taxiway shall be marked and, if the taxiway or apron taxiway is used at night, lighted.

6.1.3.6 Standard.— All elevated objects within the distance specified in 3.6.6.1 from the centre line of an aircraft stand taxiway shall be marked and, if the aircraft stand taxiway is used at night, lighted.

6.2 MARKING OF OBJECTS

6.2.1 FIXED OBJECTS

General

6.2.1.1 Standard.— All fixed objects to be marked shall, whenever possible, be coloured but if this is not possible, markers or flags shall be

displayed on or above them, except that objects that are sufficiently conspicuous by their shape, size, or colour need not otherwise be marked.

Use of colours

6.2.1.2 Standard.— The colour and form of marking displayed on objects shall be in accordance with TP 382E, Standard Obstruction Marking.

Use of markers

6.2.1.3 Standard.— Markers displayed on or adjacent to objects shall be located in conspicuous positions so as to retain the general definition of the object, and shall be recognizable in clear weather from a distance of at least 1000 m for an object to be viewed from the air and 300 m for an object to be viewed from the ground in all directions in which an aircraft is likely to approach the object. The shape of markers shall be distinctive to the extent necessary to ensure that they are not mistaken for markers employed to convey other information, and they shall be such that the hazard presented by the object they mark is not increased.

6.2.1.4 Standard.— Markers displayed on overhead wires, catenaries, etc. shall be in accordance with TP 382E, Standard Obstruction Marking.

6.2.1.5 Recommendation.— A marker should be of one colour. When installed, white and red, or white and orange markers should be displayed alternately. The colour selected should contrast with the background against which it will be seen.

Use of flags

6.2.1.6 Standard.— Flags used to mark fixed objects shall be displayed around, on top of, or around the highest edge of, an object. When flags are used to mark extensive objects or groups of closely spaced objects, they shall be displayed at least every 15 m. Flags shall not increase the hazard presented by the object they mark.

6.2.1.7 Recommendation.— Flags used to mark fixed objects should be orange in colour or a combination of orange and white except that where such colours merge with the background, other conspicuous colours should be used.

6.2.2 MOBILE OBJECTS

General

6.2.2.1 Standard.— All mobile objects to be marked shall be coloured or display flags.

Use of colours

6.2.2.2 Recommendation.— When mobile objects are marked by colour, a single conspicuous colour, preferably red or yellowish green for emergency vehicles and yellow for service vehicles should be used.

Use of flags

6.2.2.3 Standard.— Flags used to mark mobile objects shall be rectangular and not less than 0.9 m on a side.

6.2.2.4 Standard.— Flags used to mark mobile objects shall consist of a chequered pattern, each square having sides of not less than 0.3 m. The colours of the pattern shall contrast with each other and with the background against which they will be seen. Orange and white, or alternately, red and white shall be used, except where such colours merge with the background.

6.3 LIGHTING OF OBJECTS

6.3.1 FIXED OBJECTS

6.3.1.1 Standard.— All fixed objects to be lighted shall be lighted in accordance with the standards contained within Transport Canada publication, TP 382E, Standard Obstruction Markings Manual.

6.3.2 MOBILE OBJECTS

6.3.2.1 Standard.— Mobile objects to be lighted shall display flashing yellow lights except for vehicles associated with an emergency which shall display flashing red, or flashing red and flashing yellow. The flash frequency shall be between 60 and 90 per minute. The effective intensity of the flash shall be not less than 40 cd of red or yellow light.

6.3.2.2 Standard.— Objects with limited mobility such as aerobridges shall be marked with steady red low intensity obstruction lighting.

CHAPTER 7. VISUAL AIDS FOR DENOTING RESTRICTED USE AREAS

7.1 CLOSED RUNWAYS AND TAXIWAYS, OR PARTS THEREOF

7.1.1 CLOSED MARKINGS

Application

7.1.1.1 Standard.— A closed marking shall be displayed on a runway or taxiway, or portion thereof, which is permanently closed to the use of all aircraft.

7.1.1.2 Recommendation.— A closed marking should be displayed on a temporarily closed runway or taxiway or portion thereof, except that such marking may be omitted when the closing is of short duration and adequate warning by air traffic services is provided.

Location

7.1.1.3 Standard.— On a runway a closed marking shall be placed at each end of the runway, or portion thereof, declared closed, and additional markings shall be so placed that the maximum interval between markings does not exceed 300

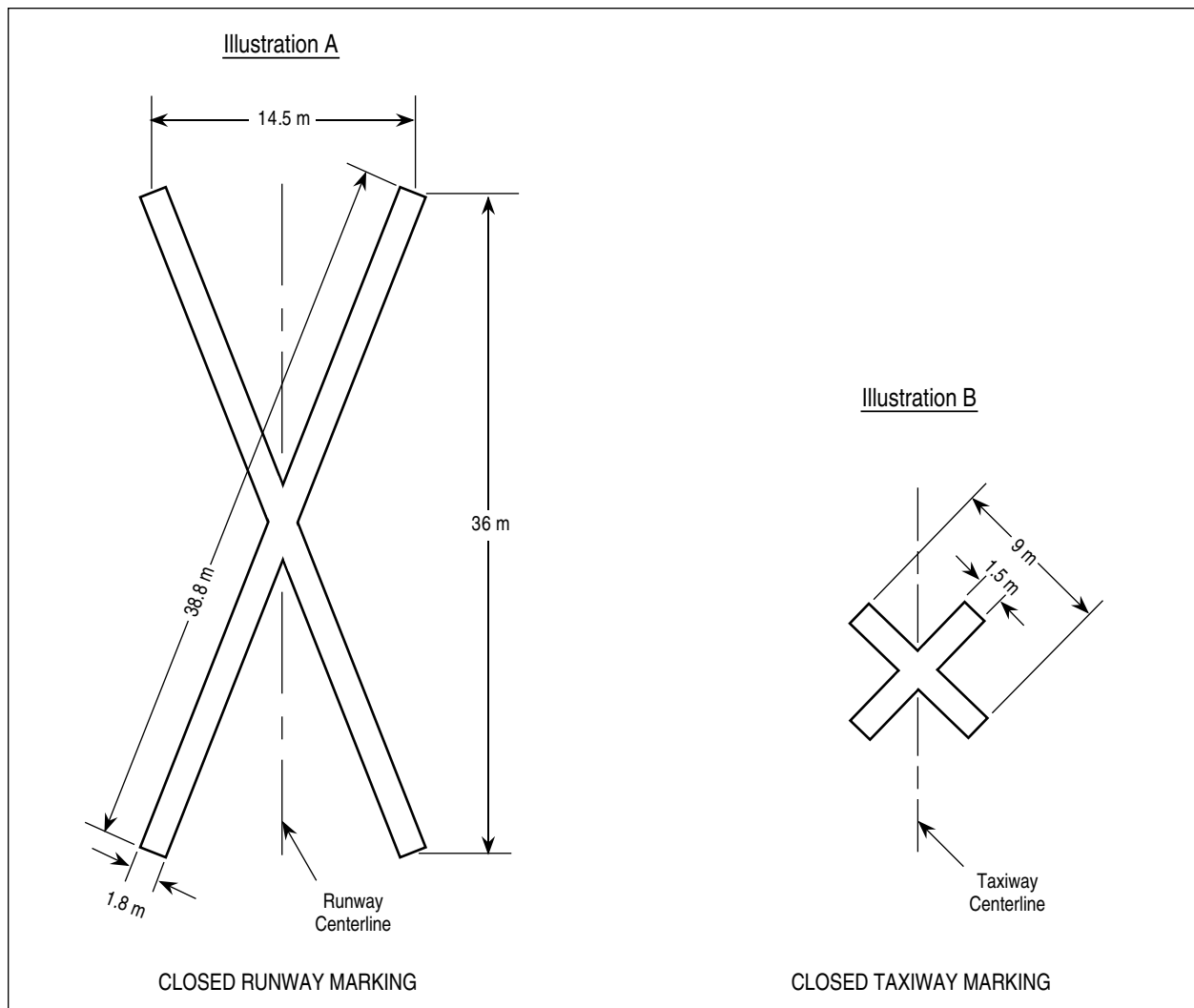

Figure 7-1. Closed runway and Taxiway Markings

m. On a taxiway a closed marking shall be placed at least at each end of the taxiway or portion thereof closed.

Characteristics

7.1.1.4 Standard.— The closed marking shall be of the form and proportions as detailed in Figure 7-1, Illustration A, when displayed on a runway, and proportions as detailed in Figure 7-1, Illustration B when displayed on a taxiway. The marking shall be white when displayed on a runway and shall be yellow when displayed on a taxiway.

Note 1.— When an area is temporarily closed, frangible barriers or markings utilizing materials other than paint or other suitable means may be used to identify the closed area.

Note 2.— Where a portion of a runway is not usable due to the accumulation of snow, conspicuous coloured dye has proven to be useful to form the closed markings.

7.1.1.5 Standard.— When a runway or taxiway or portion thereof is permanently closed, all normal runway and taxiway markings shall be obliterated.

7.1.2 LIGHTING

General

7.1.2.1 Standard.— Lighting on a closed runway or taxiway or portion thereof shall not be operated, except as required for maintenance purposes.

7.1.2.2 Standard.— In addition to closed markings, when the runway or taxiway or portion thereof closed is intercepted by a usable runway or taxiway which is used at night, unserviceability lights shall be placed across the entrance to the closed area at intervals not exceeding 3 m (see 7.4.2).

7.2 NON LOAD-BEARING SURFACES

7.2.1 TAXI SIDE STRIPE MARKING

Application

7.2.1.1 Standard.— Shoulders for taxiways, holding bays and aprons and other non load-bearing surfaces which cannot readily be distinguished from load-bearing surfaces and which, if used by aircraft, might result in damage to the aircraft shall have the boundary between such areas and the load-bearing surface marked by a taxi side stripe marking.

Note.—The marking of runway sides is specified in 5.2.7.

Location

7.2.1.2 Recommendation.— A taxi side stripe marking should be placed along the edge of the load-bearing pavement, with the outer edge of the marking approximately on the edge of the load-bearing pavement.

Characteristics

7.2.1.3 Recommendation.— A taxi side stripe marking should consist of a pair of solid lines, each 15 cm wide and spaced 15 cm apart and the same colour as the taxiway centre line marking.

Note.— Guidance on providing additional transverse stripes at an intersection or a small area on the apron is given in the *Aerodrome Design Manual, Part 4*.

7.3 PRE- THRESHOLD AREAS

shall be identified by a transverse stripe as detailed in 5.2.4.8 to 5.2.4.10.

7.3.1 CHEVRON MARKING

Application

Note.— Examples of paved pre-threshold areas include, but are not limited to, stopways and blast pads.

7.3.1.1 Standard.— When the surface before a threshold is paved and exceeds 60 m in length and is not suitable for normal use by aircraft, the entire length before the threshold shall be marked with a chevron marking.

7.3.1.2 Recommendation.— When the surface before a threshold is paved and is 60 m in length or less and is not suitable for normal use by aircraft, consideration should be given to marking the entire length before the threshold with a chevron marking.

Note.— Chevron markings are not to be applied to closed portions of runways (see 7.1)

7.3.1.3 Standard.— Where chevron markings have been applied, the runway threshold

Location

7.3.1.4 Standard.— A chevron marking shall point in the direction of the runway and originate at the threshold as shown in Figure 7-2.

7.3.1.5 Standard.— The maximum interval between individual chevrons shall be 30 m and the minimum interval shall be 15 m.

7.3.1.6 Recommendation.— The interval between individual chevrons should be 30 m.

Note.— The interval between chevrons may be adjusted to achieve the maximum clearances between pavement edge and chevrons as shown in Figure 7-2.

Characteristics

7.3.1.7 Standard.— A chevron marking shall be yellow.

7.3.1.8 Recommendation.— A chevron marking should have an over-all width of at least 0.9 m.

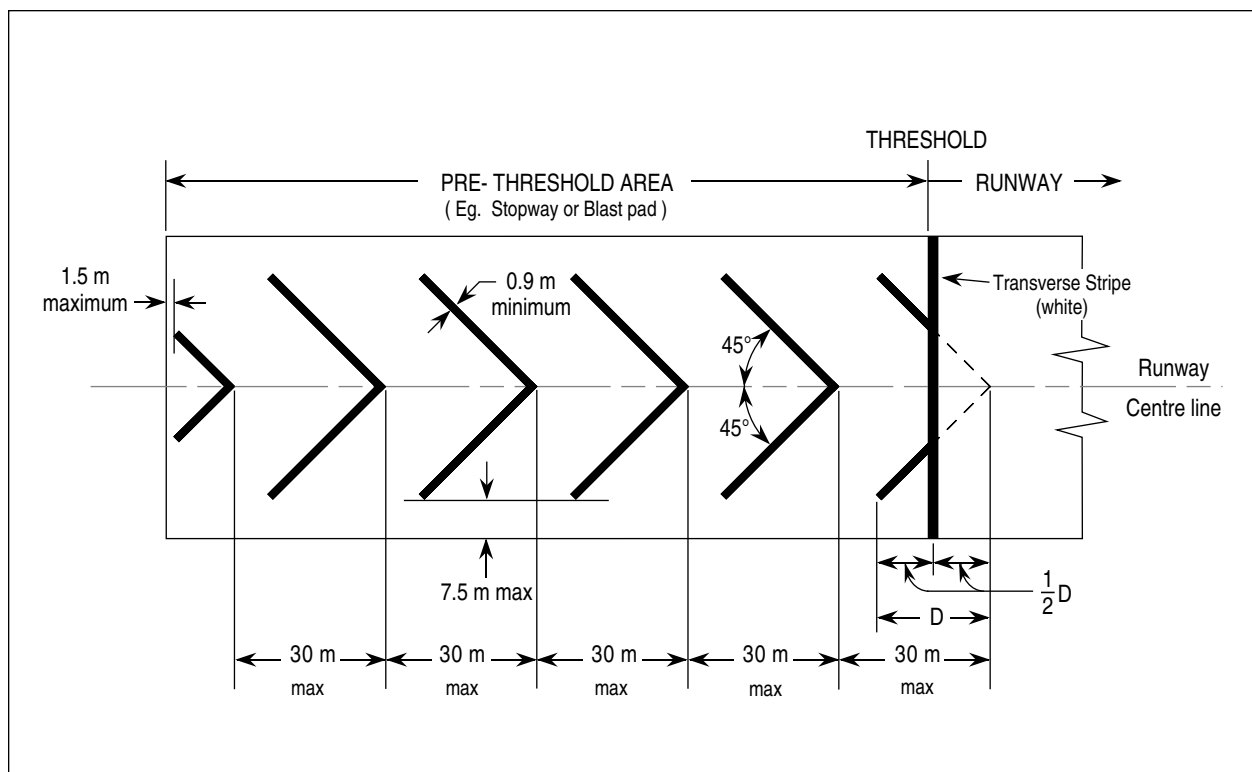

Figure 7-2. Chevron Marking

7.4 UNSERVICEABLE AREAS

7.4.1 UNSERVICEABILITY MARKERS

Application

7.4.1.1 Standard.— Unserviceability markers shall be displayed wherever any portion of a taxiway, apron or holding bay is unfit for the movement of aircraft but it is still possible for aircraft to bypass the area safely.

Note.— *Unserviceability markers are used for such purposes as warning pilots of a hole in a taxiway or apron pavement or outlining a portion of pavement, such as on an apron, that is under repair. They are not suitable for use when a portion of a runway becomes unserviceable, nor on a taxiway when a major portion of the width becomes unserviceable. In such instances, the runway or taxiway is normally closed.*

Location

7.4.1.2 Standard.— Unserviceability markers shall be placed at intervals sufficiently close so as to delineate the unserviceable area.

Characteristics

7.4.1.3 Standard.— Unserviceability markers shall consist of conspicuous upstanding devices such as flags, cones, or marker boards.

7.4.1.4 Recommendation.— An unserviceability cone should be at least 0.5 m in height and red or international orange in combination with white.

7.4.1.5 Recommendation.— An unserviceability flag should be at least 0.5 m square and red or international orange in combination with white.

7.4.1.6 Recommendation.— An unserviceability marker board should be at least 0.5 m in height and 0.9 m in length, with alternate red and white or international orange and white vertical stripes.

7.4.2 UNSERVICEABILITY LIGHTS

Application

7.4.2.1 Standard.— Unserviceability lights shall be displayed wherever any portion of a taxiway, apron or holding bay used at night is unfit for the movement of aircraft but it is still possible for aircraft to bypass the area safely.

Note.— *Unserviceability lights are used for such purposes as warning pilots of a hole in a taxiway or apron pavement or outlining a portion of pavement, such as on an apron, that is under repair. They are not suitable for use when a portion of a runway becomes unserviceable, nor on a taxiway when a major portion of the width becomes unserviceable. In such instances, the runway or taxiway is normally closed.*

Location

7.4.2.2 Standard.— Unserviceability lights shall be placed at intervals sufficiently close so as to delineate the unserviceable area.

Characteristics

7.4.2.3 Standard.— An unserviceability light shall consist of a red fixed light. The red fixed light shall have an intensity sufficient to ensure conspicuity considering the intensity of the adjacent lights and the general level of illumination against which it would normally be viewed. In no case shall the intensity be less than 10 cd of red light.

CHAPTER 8. EQUIPMENT, INSTALLATIONS and OPERATIONS

8.1 ELECTRICAL SYSTEMS

8.1.1 SECONDARY POWER SUPPLY

GENERAL

Application

8.1.1.1 Recommendation.— A secondary power supply should be provided, capable of supplying the power requirements of at least the aerodrome facilities listed below:

- a) all obstacle lights which, in the opinion of the certifying authority, are essential to ensure the safe operation of aircraft;
- b) approach, runway and taxiway lighting as specified in 8.1.1.5 to 8.1.1.8;
- c) meteorological equipment;
- d) essential security lighting, if provided in accordance with 8.4.2;
- e) essential equipment and facilities for the aerodrome responding emergency agencies; and
- f) floodlighting on a designated isolated aircraft parking position if provided in accordance with 5.3.21.1.

Characteristics

8.1.1.2 Recommendation.— Electric power supply connections to those facilities for which secondary power is required should be so arranged that the facilities are automatically connected to the secondary power supply on failure of the normal source of power.

8.1.1.3 Recommendation.— The time interval between failure of the normal source of power and the complete restoration of the services required by 8.1.1.1 should be as short as practicable and should not exceed two minutes,

except that the requirements of Table 8-1 should apply to visual aids associated with instrument runways.

Note.— *In certain cases, less than thirty seconds has been found to be attainable.*

8.1.1.4 Standard.— Requirements for a secondary power supply shall be met by either of the following:

- independent public power, which is a source of power supplying the aerodrome service from a substation other than the normal substation through a transmission line following a route different from the normal power supply route and such that the possibility of a simultaneous failure of the normal and independent public power supplies is extremely remote; or
- standby power unit(s), which are engine generators, batteries, etc., from which electric power can be obtained.

Note.— *Guidance on secondary power supply is given in the ICAO Aerodrome Design Manual, Part 5.*

VISUAL AIDS

Application

8.1.1.5 Recommendation.— At an aerodrome where the primary runway is a non-instrument runway, a secondary power supply capable of meeting the requirements of paragraph 8.1.1.3 should be provided, except that a secondary power supply for visual aids need not be provided when an emergency lighting system in accordance with the specification of 5.3.2 is provided and capable of being deployed in 15 minutes.

Note.— *Guidance on means of achieving the specified secondary power supply switch-over time, etc., is given in the ICAO Aerodrome Design Manual, Part 5.*

**Table 8-1. Secondary power supply requirements
(see 8.1.3)**

Runway type	Visual aids (lighting) requiring power	Maximum switch-over time
(1)	(2)	(3)
Non-instrument	Visual approach slope indicators ^a Runway edge ^c Runway threshold ^c Runway end ^c Obstacle ^a	Not specified
Non-precision approach	Approach lighting system Visual approach slope indicators ^a Runway edge Runway threshold Runway end Obstacle ^a	15 seconds 15 seconds 15 seconds 15 seconds 15 seconds 15 seconds
Precision approach category I	Approach lighting system Runway edge PAPI Runway threshold Runway end Essential taxiway Obstacle ^a	15 seconds 15 seconds 15 seconds 15 seconds 15 seconds 15 seconds 15 seconds
Precision approach category II & III	Approach lighting system Supplementary approach lighting barrettes Obstacle ^a Runway edge Runway threshold Runway end Runway centre line Runway touchdown zone All stop bars Essential taxiway	15 seconds 1 second 15 seconds 15 seconds 1 second 1 second 1 second 1 second 1 second 15 seconds
Take-off runway intended for use in runway visual range conditions less than a value of the order of 2600 ft (800 m).	Runway edge Runway end Runway centre line All stop bars Essential taxiway ^a Obstacle ^a	15 seconds ^b 1 second 1 second 1 second 15 seconds 15 seconds
<p>Note a.— Supplied with secondary power when their operation is essential to the safety of flight operation.</p> <p>Note b.— 1 second where no runway centre line lights are provided.</p> <p>Note c.— See chapter 5, section 5.3.2 regarding the use of emergency lighting.</p>		

8.1.1.6 Recommendation.— At an aerodrome where the primary runway is a non-precision approach runway, a secondary power supply capable of meeting the requirements of Table 8-1 should be provided except that a secondary power supply for visual aids need not be provided for more than one non-precision approach runway.

8.1.1.7 Standard.— For a precision approach runway, a secondary power supply capable of meeting the requirements of Table 8-1 for the appropriate category of precision approach runway shall be provided.

8.1.1.8 Standard.— For a runway intended to be used for take-off with an operating minimum below an RVR of the order of 1400 ft (400 m), a secondary power supply capable of meeting the relevant requirements of Table 8-1 shall be provided.

8.1.1.9 Standard.— Where secondary power is provided, the following aerodrome visual aids shall be provided with a secondary power source:

- a) Precision approach category I lighting systems;
- b) Precision approach category II and III lighting systems;
- c) Runway and taxiway centre line lights;
- d) Touchdown zone lights;
- e) Runway edge lights; and
- f) apron lighting – those luminaires that provide illumination to the apron areas over which passengers will walk from the aircraft to the terminal except that it is not required when deplaning is by means of passenger loading bridges or passenger transport vehicles.

8.1.2 CIRCUIT DESIGN

8.1.2.1 Standard.— For a precision approach runway and a take-off runway intended for use in runway visual range conditions less than a value of the order of 2600 ft (800 m), the electrical circuits for the power supply, lighting and control of the lighting systems included in Table

8-1 shall be so designed that the failure of one circuit will not leave the pilot without visual guidance or will not result in a misleading or inadequate pattern.

8.1.2.2 Standard.— Where a runway forming part of a standard taxi-route is provided with runway lighting and taxiway lighting, the lighting systems shall be interlocked to preclude the possibility of simultaneous operation of both forms of lighting.

8.1.2.3 Standard.— Where the secondary power supply of an aerodrome is provided by the use of duplicate feeders, such supplies shall be physically and electrically separate so as to ensure the required level of availability and independence.

Note.— Guidance on this subject is given in the ICAO Aerodrome Design Manual, Part 5.

8.1.3 STANDBY POWER UNIT OPERATION

8.1.3.1 Recommendation.— Where the secondary power requirement is met by a standby power unit, the standby power unit should be operated to provide the primary power and the utility source be made available to supply secondary power during periods when a runway is in use with an RVR of the order of 1400 ft (400 m).

8.2 NOT ALLOCATED

8.3 MONITORING

8.3.1 VISUAL AIDS

Note.— Guidance on this subject is given in the ICAO Aerodrome Design Manual.

General

8.3.1.1 Recommendation.— A system of monitoring visual aids should be employed to ensure lighting system reliability.

8.3.1.2 Standard.— APAPI installations shall be inspected on a daily basis to detect an out of level condition or, alternately, shall be fitted with an automatic shut-off switch which will extinguish both units in the event of a misalignment on one or both units.

Note.— This is to preclude a misalignment on one or both APAPI units caused by a nature (eg. frost heaves) or by physical interference which could result in a dangerously low “on slope” indication.

Automatic monitoring

8.3.1.3 Standard.— Where lighting systems are used for aircraft control purposes, such systems shall be monitored automatically so as to provide an immediate indication of any fault which may affect the control functions. This information shall be automatically relayed to the air traffic service unit.

8.3.1.4 Recommendation.— For a precision approach runway and runways intended to be used for take-off with an operating minimum below an RVR of the order of 2600 ft (800 m), the lighting systems detailed in Table 8-1 should be monitored so as to provide an immediate indication when the serviceability level of any element falls below the minimum serviceability level specified in paragraphs 9.4.3.2 to 9.4.3.7 as appropriate. This information should be immediately relayed to the maintenance centre.

8.3.1.5 Recommendation.— For a precision approach runway and runways intended to be used for take-off with an operating minimum below an RVR of the order of 2600 ft (800 m), the lighting systems detailed in Table 8-1 should be monitored automatically to provide an immediate indication when the serviceability level of any element falls below the minimum specified serviceability level, below which operations should not continue. This information should be automatically relayed to the air traffic services unit.

Note.— Guidance on air traffic control interface and visual aids monitoring is included in the ICAO Aerodrome Design Manual, Part 5.

8.4 SECURITY

8.4.1 FENCING

Note.— In addition to the specifications contained below, airports which receive scheduled passenger service may require additional security measures as contained in the Aerodrome Security Regulations.

Application

8.4.1.1 Recommendation.— A fence or other suitable barrier should be provided on an aerodrome to prevent the entrance to the movement area of animals large enough to be a hazard to aircraft.

8.4.1.2 Recommendation.— A fence or other suitable barrier should be provided on an aerodrome to deter the inadvertent or premeditated access of an unauthorized person to a non-public area of the aerodrome.

Note 1.— This is intended to include the barring of sewers, ducts, tunnels, etc., where necessary to prevent access.

Note 2.— Special measures may be required to prevent the access of an unauthorized person to runways or taxiway which overpass public roads.

8.4.1.3 Recommendation.— Suitable means of protection should be provided to deter the inadvertent or premeditated access of unauthorized persons into ground installations and facilities essential for the safety of civil aviation located off the aerodrome.

Location

8.4.1.4 Recommendation.— The fence or barrier should be located so as to separate the movement area and other facilities or zones on the aerodrome vital to the safe operation of aircraft from areas open to public access.

8.4.1.5 Recommendation.— When greater security is thought necessary, a cleared area should be provided on both sides of the fence or barrier to facilitate the work of patrols and to make trespassing more difficult. Consideration should be given to the provision of a perimeter road inside the aerodrome fencing for the use of both

maintenance personnel and security patrols.

8.4.2 SECURITY LIGHTING

8.4.2.1 Recommendation.— At an aerodrome where it is deemed desirable for security reasons, a fence or other barrier provided for the protection of the aerodrome and its facilities should be illuminated at a minimum essential level. Consideration should be given to locating lights so that the ground area on both sides of the fence or barrier, particularly at access points, is illuminated.

8.5 OPERATION AND CONTROL OF AERODROME LIGHTING SYSTEMS

8.5.1 GENERAL

Application

8.5.1.1 Standard.— Except for aerodromes utilizing ARCAL as specified in sub-section 8.5.2, aerodrome lighting shall be operated as specified in 8.5.1.2 to 8.5.1.18, or as requested by the pilot, or as required to facilitate and safeguard aerodrome traffic.

Continuous or automatic operation

8.5.1.2 Standard.— Where aerodrome light systems are to be operated continuously during the night, this shall be considered to be between evening and morning civil twilight.

8.5.1.3 Recommendation.— Where aerodrome light systems are controlled automatically by means of a photoelectric device, the on and off settings should be between 300 lux and 500 lux of northern sky illuminance.

8.5.1.4 Standard.— Where provided, aerodrome flight manoeuvring area hazard lights shall operate continuously at night.

Non continuous operation

8.5.1.5 Standard.— Where aerodrome lighting systems are controlled manually, the light intensity settings shall be selected in accordance with Table 8-2.

Note 1.— In pavement lighting may be operated as necessary to prevent or melt ice and snow accumulation.

Note 2.— The lighted wind direction indicators are normally interlocked and operate in conjunction with the runway edge lights.

8.5.1.6 Standard.— Approach lighting shall be operated at night or in daytime IMC conditions for an arriving aircraft;

- a) for not less than 5 minutes prior to the ETA of the aircraft; and
- b) until the aircraft has landed.

8.5.1.7 Standard.— Runway identification lights shall be operated for an arriving aircraft when;

- a) the visibility is 5 miles or less; or
- b) the ceiling is 1000 ft or less.

8.5.1.8 Standard.— Runway edge, runway centreline and touchdown zone lighting shall be operated at night or in daytime IMC condition for an arriving aircraft:

- a) for not less than 5 minutes prior to the ETA of the aircraft; and
- b) until the aircraft has taxied clear of the runway.

8.5.1.9 Standard.— Runway edge and runway centreline lighting shall be operated at night or in daytime IMC condition for a departing aircraft:

- a) before the aircraft enters the runway; and
- b) until at least 3 minutes after the aircraft has departed.

8.5.1.10 Standard.— Visual approach slope indicator systems shall be operated when the runway is in use except that the system shall not be operated when:

- a) an aircraft is conducting a precision approach; and
- b) weather conditions are less than a ceiling of 500 ft or the visibility is less than 1 mile.

8.5.1.11 Standard.— Taxiway edge, taxiway centre line lights and apron edge lights shall be operated such that a continuous indication of the taxi route is presented.

Note.— Taxiway intersection lights are operated in conjunction with the taxiway centreline lights.

8.5.1.12 Standard.— Stop bars shall be operated in runway visual range conditions of a value of 2600 ft (800 m) or less whenever a vehicle or aircraft is operating on the manoeuvring area.

8.5.1.13 Standard.— Runway guard lights shall be operated in runway visual range conditions of a value of 2600 ft (800 m) or less whenever a vehicle or aircraft is operating on the manoeuvring area.

8.5.1.14 Recommendation.— Whenever an aircraft or vehicle is operating on the manoeuvring area stop bars and runway guard lights should be operated:

- a) at night in all visibility conditions; and
- b) during the day in visibility of 3 miles or less.

Table 8-2. Intensity settings for medium and high intensity light systems

Visibility less than:	NIGHT					DAY			
	1/2 mile (RVR 2600)	1 mile (RVR 5000)	2 miles	3 miles	3 miles or greater	1 mile (RVR 5000)	2 miles	3 miles	3 miles or greater
(1)	(2)	(3)	(4)	(6)	(7)	(8)	(9)	(10)	(11)
High intensity systems: (5 settings)									
Precision approach Cat II/III	4	3	2	2	1	5	4	4	3
Precision approach Cat I	4	3	2	2	1	5	4	4	3
Runway edge	4	3	2	2	1	5	4	4	3
Runway centre line	4	3	2	2	1	5	4	4	3
Touchdown zone lighting	4	3	2	2	1	5	4	4	3
PAPI (5 settings)	3	3	3	3	3	4-5	4-5	4-5	4-5
Medium intensity systems: (3 settings)									
Precision approach Cat I	3	3	2	1	1	3	2	2	2
Non-precision approach	3	3	2	1	1	3	3	2	2
Runway edge	3	3	2	1	1	3	3	3	2
Runway identification lights	3	3	2	2	1	3	3	3	2
PAPI (3 settings)	1	1	1	1	1	2-3	2-3	2-3	2-3

Notes:

- i) Visibilities are measured in statute miles and RVR values are given in feet.
- ii) Light setting "5" for high intensity systems is available on pilot request.
- iii) Where Runway visual range information (RVR) is provided, the runway edge intensity setting switch must not be left on setting 4 or 5 when the lights are off since this will result in incorrect RVR readings.
- iv) Any setting may be adjusted up or down at pilot request.
- v) Runway identification lights are selected at intensity setting 1 when the day visibility is in excess of 5 miles

8.5.1.15 Standard.— Obstruction lights shall be operated:

- a) continuously at night; and
- b) during the day when the visibility is 3 miles or less.

8.5.1.16 Standard.— Road hold position lights shall be operated in runway visual range conditions of a value of 2600 ft (800 m) or less whenever a vehicle is operating on the manoeuvring area.

8.5.1.17 Recommendation.— Whenever a vehicle is operating on the manoeuvring area a road hold position lights should be operated;

- a) at night in all visibility conditions; and
- b) during the day in visibility of 3 miles or less.

Note.— Apron flood lights and aircraft stand manoeuvring lights are operated in accordance with an agreement between the unit providing apron advisory service and the aerodrome operator.

Selection of light system intensity

8.5.1.18 Standard.— Where a light system has been provided with intensity control in accordance with 5.3.1.11, the selection of intensity shall be suitable for prevailing conditions and be in accordance with Table 8-2 except that any selection may be made at the request of a pilot using the visual aid.

8.5.2 AIRCRAFT RADIO CONTROL OF AERODROME LIGHTING (ARCAL)

Note.— The inclusion of detailed specifications for Aircraft Radio Control of Aerodrome Lighting Systems does not imply that such systems are required to be provided.

Application

8.5.2.1 Recommendation.— Where ARCAL is provided, control should be exercised over the following visual aid components where installed:

- a) approach lighting systems;
- b) runway lighting;
- c) taxiway lighting;
- d) visual approach slope indicator;
- e) runway identification lights;
- f) wind direction indicator light; and
- g) aerodrome beacon except that the aerodrome beacon should operate continuously at night where the certifying authority determines the aerodrome is required for enroute navigation purposes.

Note.— ARCAL systems are generally available in two forms; Type J allows connected systems to be activated at a single intensity, Type K allows three selections of connected systems and are generally used to scale the light intensity selection on connected high and medium intensity lights.

8.5.2.2 Standard.— Aerodrome flight manoeuvring area hazard lights shall not be operated by an ARCAL system.

8.5.2.3 Standard.— An ARCAL system shall operate 24 hours per day except that at aerodromes where air traffic services are provided by a control tower, flight service station or community airport radio station, the system shall not operate during the hours when the services are provided.

Characteristics

8.5.2.4 Standard.— Where it is intended that an ARCAL system is to operate a precision approach category I lighting system and associated medium or high intensity runway lighting, the ARCAL system shall be capable of selection of at least three intensity settings (eg. ARCAL type K).

Selection of operating frequency

8.5.2.5 Standard.— At aerodromes where air traffic services are provided the ARCAL system shall operate on the published Mandatory Frequency (MF).

8.5.2.6 Recommendation.— At uncontrolled aerodromes the ARCAL should operate on the Aerodrome Traffic Frequency (ATF).

Note.— *The Department of Communications allocates frequencies to ensure a minimum of interferences and should be consulted concerning the selection of air-to-ground frequencies.*

System operation

8.5.2.7 Standard.— The radio receiver equipment shall control the aerodrome visual aids by decoding a series of radio transmissions generated by keying of the aircraft transmitter microphone a specified number of times within a 5 second period.

8.5.2.8 Standard.— Except for runway identification lights and the sequenced flashing lights on precision approach category I light systems, ARCAL systems shall only be capable of automatic shut off not less than 15 minutes after being activated. The 15 minute time period shall recommence every time an operation or brightness selection is made.

8.5.2.9 Standard.— At aerodromes where there is no intensity control of aerodrome lighting, keying the microphone 5 times shall activate the ground system.

8.5.2.10 Standard.— The ARCAL selection of light intensity shall be in accordance with Table 8-3.

Table 8-3. Intensity settings for lighting systems activated by ARCAL

Visual Aid System	Number of intensity settings	Selected Intensity Setting			Single step ARCAL (type J)
		3 Step ARCAL (type K)			
(1)	(2)	(3)			(4)
		3 clicks	5 clicks	7 clicks	
Approach Lighting: ODALS	3	1	2	3	2
MALSR	3	1	2	3	----
SALSR	5	1	3	4	----
Runway Edge Lighting: High Intensity	5	1	3	4	----
Medium Intensity	3	1	2	3	----
Low Intensity	1	1	1	1	1
Taxiway Edge Lighting: Medium Intensity	3	1	2	3	2
Low Intensity	1	1	1	1	1
PAPI and APAPI:	3	1	2	3	1
	5	3	4	5	3
Runway Identification Lights (RILS)	3	OFF	OFF or 2	3	3
Wind Direction Indicator	1	1	1	1	1
Aerodrome Beacon	1	1	1	1	1

Note.— *Settings for Type J ARCAL have been omitted for those systems where it is not intended that they will be controlled by type J ARCAL.*

8.6 SITING AND CONSTRUCTION OF EQUIPMENT AND INSTALLATIONS ON OPERATIONAL AREAS

8.6.1 GENERAL

Note 1.— Requirements for obstacle limitation surfaces are specified in 4.2.

Note 2.— The design of light fixtures and their supporting structures, light units of visual approach slope indicators, signs, and markers is specified in 5.3.1, 5.3.6, 5.4.1 and 5.5.1, respectively. Guidance on the frangible design of lights and other navigation aids is given in the ICAO Airport Services Manual, Part 6.

8.6.1.1 Standard.— Unless its function requires it to be there for air navigation purposes, no equipment or installation shall be:

- a) on a runway strip, a runway end safety area, a taxiway strip or within the distances specified in Table 3-1, column 4, if it would endanger an aircraft; or
- b) on a clearway if it would endanger an aircraft in the air.

8.6.1.2 Recommendation.— Any equipment or installation required for air navigation purposes which must be located in an area identified in 8.6.1.1, should be regarded as an obstacle and should be of minimum practicable mass and height, be frangible, and sited in such a manner as to reduce the hazard to aircraft to a minimum.

8.6.1.3 Standard.— Any equipment or installation required for air navigation purposes which must be located on or near a strip of a precision approach runway and which:

- a) is situated on that portion of the strip within:
 - i) 60 m of the runway centre line where the code number is 3 or 4; or
 - ii) 45 m of the runway centre line where the code number is 1 or 2; or

- b) penetrates the take-off/approach surface or the inner transitional surface;

shall be of minimum practical mass and height, be frangible, and sited in such a manner as to reduce the hazard to aircraft to a minimum.

8.6.1.4 Recommendation.— Any equipment or installation required for air navigation purposes and which is an obstacle of operational significance in accordance with 4.2.2.7, 4.2.3.5 or 4.2.4.6, should be of minimum practicable mass and height, be frangible, and sited in such a manner as to reduce the hazard to aircraft to a minimum.

8.7 AERODROME VEHICLE OPERATION

8.7.1 GENERAL

Note 1.— Guidance on aerodrome vehicle operations is contained in;

- a) *Manual of Airport Traffic Directives for the Operation of Vehicles on Airport Movement Areas TP 2633; and,*
- b) *the ICAO Manual of Surface Movement Guidance and Control Systems (SMGCS).*

Note 2.— It is intended that roads located on the movement area be restricted to the exclusive use of aerodrome personnel and other authorized persons, and that access to the public buildings by an unauthorized person will not require use of such roads.

8.7.1.1 Standard.— A vehicle shall be operated:

- a) on the manoeuvring area only as authorized by the air traffic services unit, airport operator or designate; and
- b) on the apron only as authorized by the appropriate designated authority.

8.7.1.2 Standard.— At aerodromes where air traffic services, an authorized approach unicom, or community airport radio station (CARS), are

provided, vehicles operating on the manoeuvring area shall be equipped with suitable two way radio communication or be accompanied by a vehicle or person with appropriate radio communication equipment.

Note 1.— At aerodromes where air traffic services or an authorized approach unicom is not provided, the requirement to equip vehicles with radios will be determined by the airport operator taking into account the density of air traffic, the visibility conditions under which operations are intended, complexity of the aerodrome layout and number of vehicles operating.

Note 2.— At aerodromes having approved instrument approach procedures it is desirable that vehicles operating on the manoeuvring area be capable of complying with the provisions of 8.7.1.3.

8.7.1.3 Standard.— The driver of a vehicle on the movement area shall comply with all mandatory instructions conveyed by marking and signs unless:

- a) otherwise authorized by the air traffic services unit, airport operator or designate when on the manoeuvring area;
- b) otherwise authorized by the appropriate designated authority when on the apron; or
- c) giving way to aircraft.

8.7.1.4 Standard.— The driver of a vehicle on the movement area shall comply with all mandatory instructions conveyed by lights.

8.7.1.5 Standard.— The driver of a vehicle on the movement area shall be appropriately trained for the tasks to be performed and shall comply with the instructions issued by:

- a) the air traffic services unit, airport operator or designate when on the manoeuvring area; and
- b) the appropriate designated authority, when on the apron.

8.7.1.6 Standard.— Where air traffic services, an authorized approach unicom, or community airport radio station (CARS), are provided, the driver of a radio equipped vehicle shall establish satisfactory two-way radio

communication with the unit on the mandatory frequency or air traffic frequency, as appropriate, before entering the manoeuvring area.

8.7.1.7 Standard.— Where the services specified in 8.7.1.6 are not provided, or during any period that the services specified in 8.7.1.6 are not available (eg. less than 24 hour operation), the driver of a radio equipped vehicle shall:

- a) prior to entering or changing location on the manoeuvring area broadcast position and intentions on the mandatory frequency or air traffic frequency, as appropriate;
- b) when on the manoeuvring area advise pilots of their position and intentions;
- c) when requested, provide runway condition reports and the location of other known ground traffic on the manoeuvring area; and
- d) give way to aircraft at all times.

8.7.1.8 Standard.— The driver of a radio equipped vehicle shall maintain a continuous listening watch on the appropriate frequency when on the movement area.

8.8 SURFACE MOVEMENT GUIDANCE AND CONTROL SYSTEMS

8.8.1 GENERAL

Application

8.8.1.1 Standard.— A surface movement guidance and control system shall be provided at an aerodrome intended to be used in runway visual range conditions less than a value of the order of 1400 ft (400 m).

8.8.1.2 Recommendation.— A surface movement guidance and control system should be provided at an aerodrome:

- a) intended to be used in runway visual range conditions of a value of the order of 2600 ft (800 m) or less, or

- b) where the traffic density is heavy.

Note.— Guidance on surface movement guidance and control systems is contained in the ICAO Manual of Surface Movement Guidance and Control Systems (SMGCS).

Characteristics

8.8.1.3 Recommendation.— The design of a surface movement guidance and control system should take into account:

- a) the density of air traffic;
- b) the visibility conditions under which operations are intended;
- c) the need for pilot orientation;
- d) the complexity of the aerodrome layout; and
- e) movements of vehicles.

8.8.2 VISUAL AIDS

Characteristics

8.8.2.1 Recommendation.— The visual aid components of a surface movement guidance and control system, i.e. markings, lights and signs should be designed to conform with the relevant specifications in 5.2, 5.3 and 5.4, respectively.

8.8.2.2 Recommendation.— A surface movement guidance and control system should be designed to assist in the prevention of inadvertent incursions of aircraft and vehicles onto an active runway.

8.8.2.3 Recommendation.— The system should be designed to assist in the prevention of collisions between aircraft, and between aircraft and vehicles or objects, on any part of the movement area.

8.8.2.4 Standard.— Where a surface movement guidance and control system is provided by selective switching of stop bars and taxiway centre line lights, the following requirements shall be met:

- a) taxiway routes which are indicated by illuminated taxiway centre line lights shall be

capable of being terminated by an illuminated stop bar;

- b) the control circuits shall be so arranged that when a stop bar located in the direction of movement is illuminated, the appropriate section of taxiway centre line lights beyond it is suppressed; and
- c) the taxiway centre line lights are activated in the intended direction of movement of the aircraft when the stop bar (if any) is suppressed.

Note 1.— See paragraphs 5.3.16 and 5.3.18 for specifications on taxiway centre line lights and stop bars, respectively.

Note 2.— Guidance on the installation of stop bars and taxiway centre line lights in surface movement guidance and control systems is given in the ICAO Aerodrome Design Manual, Part 4.

Note 3.— Guidance on control of stop bars through induction loops and on a visual taxiing guidance and control system is contained in the ICAO Aerodrome Design Manual, Part 4.

Note 4.— Although the guidance in Part 4 of the ICAO Aerodrome Design Manual, refers to induction loop sensors, other types of sensors such as microwave have also proven effective for stop bar control purposes.

8.8.3 NON VISUAL AIDS

Application

8.8.3.1 Recommendation.— Surface movement radar for the manoeuvring area should be provided at an aerodrome intended for use with operating minimums below an RVR of the order of 1400 ft (400 m)

8.8.3.2 Recommendation.— Surface movement radar for the manoeuvring area should be provided at an aerodrome other than that in 8.8.3.1 when traffic density and operating conditions are such that regularity of traffic flow cannot be maintained by alternative procedures and facilities.

Note.— Guidance on the use of surface movement radar is given in the ICAO Manual of

Surface Movement Guidance and Control Systems (SMGCS) and in the ICAO Air Traffic Services Planning Manual.

8.9 SIMULTANEOUS INTERSECTING RUNWAY OPERATIONS (SIRO)

Introductory Note.— SIRO operations require review and authorization by the Certifying Authority. The inclusion of detailed specifications for simultaneous intersecting runway operations does not imply that such procedures are required to be implemented.

8.9.1 GENERAL

8.9.1.1 Standard.— Where SIRO procedures are authorized, the following shall be provided on the intersected runway where aircraft will hold short of, and prior to, an intersecting runway:

- a) a taxi-hold position marking as described in 5.2.9 to indicate the hold short position; and
- b) mandatory instruction signs as described in 5.4.2 on each side of, and adjacent to, the taxi-holding position marking.

8.9.1.2 Standard.— The taxi-holding position marking specified in 8.9.1.1(a) shall be 90° to the intersected runway centre line and located at a distance not less than 60 m from the nearest edge of the intersecting runway.

8.9.1.3 Standard.— Where SIRO operations are authorized at night, the signs required in 8.9.1.1(b) shall be illuminated in accordance with 5.4.1.7 and 5.4.1.10.

Note.— It has been found that signs using imbedded fiber-optic elements provide the greatest conspicuity.

8.9.1.4 Recommendation.— Where additional conspicuity of the hold position is desired, a controllable stop bar as described in 5.3.18 should be installed in conjunction with the taxi-holding position marking.

8.9.1.5 Standard.— Stop bars installed in accordance with 8.9.1.4 shall be capable of being switched on or off by air traffic services.

8.9.1.6 Standard.— Stop bars installed in accordance with 8.9.1.4 shall not be illuminated during periods when the full length of the runway is available.

8.9.1.7 Standard.— When SIRO procedures are authorized, the reduced landing distance available (LDA) on the intersected runway, shall be determined as the distance between the threshold or displaced threshold as applicable, and the taxi-holding position marking.

CHAPTER 9. EMERGENCY AND OTHER SERVICES

9.1 AERODROME EMERGENCY PLANNING

9.1.1 EMERGENCY RESPONSE PLAN

Introductory Note.— Aerodrome emergency planning is the process of preparing an aerodrome to cope with an emergency occurring at the aerodrome or in its vicinity. The objective of aerodrome emergency planning is to minimize the effects of an emergency, particularly with respect to saving lives and maintaining aircraft operations. The aerodrome emergency plan sets forth the procedures for coordinating the response of different aerodrome agencies (or services) and of those agencies in the surrounding community that could be of assistance in responding to the emergency. Guidance material to assist the appropriate authority in establishing aerodrome emergency planning is given in:

- a) *the Airport Emergency Planning Manual, TP 1801;*
- b) *the ICAO Airport Services Manual Part 7.*

Application

9.1.1.1 Standard.— An aerodrome emergency response plan shall be established at an aerodrome, commensurate with the aircraft operations and other activities conducted at the aerodrome.

9.1.1.2 Standard.— The aerodrome emergency response plan shall provide for the coordination of the actions to be taken in an emergency occurring at an aerodrome or in its vicinity.

Note.— Examples of emergencies are: aircraft emergencies, sabotage including bomb threats, unlawfully seized aircraft, medical emergencies, dangerous goods occurrences, building fires and natural disasters. Aircraft emergencies may include aircraft crashes on or off aerodrome (in water at some sites).

9.1.1.3 Standard.— The plan shall coordinate the response or participation of all existing agencies which, in the opinion of the appropriate authority, could be of assistance in responding to an emergency.

Note.— Examples of agencies are:

- a) *on the aerodrome: air traffic services unit, rescue and fire fighting services, aerodrome administration, medical and ambulance services, aircraft operators, security services, and police;*
- b) *off the aerodrome: fire departments, police, medical and ambulance services, hospitals, military, and harbour patrol or coast guard.*

9.1.1.4 Standard.— An aerodrome which is located within 8 km of a large body of water shall include in the emergency response plan the procedure for notifying the appropriate rescue coordination centre in the event of an aircraft ditching or possibly ditching in the water.

Emergency response plan document

9.1.1.5 Standard.— The aerodrome emergency plan document shall include at least the following:

- a) types of emergencies planned for;
- b) agencies involved in the plan (both on and off the aerodrome) along with their telephone numbers and notification procedures;
- c) responsibility and role of each agency, the emergency operations centre and the command post, for each type of emergency;
- d) a clearly specified commander and chain of authority for each emergency specified and covering all phases of the emergency;
- e) information on names and telephone numbers of offices or people to be contacted in the case of a particular emergency;

- f) a list of pertinent on-aerodrome services available with telephone numbers and contact procedures;
- g) copies of Memoranda of Understanding (MOUs) or agreements with other agencies for mutual aid and the provision of emergency services; and
- h) a grid map of the aerodrome and its immediate vicinity.

9.1.1.6 Recommendation.— At aerodromes receiving regularly scheduled passenger service, aircraft crash charts should be provided to the emergency response vehicle(s) normally providing first emergency response.

Note.— *Aerodromes receiving regularly scheduled passenger carrying aircraft are eligible to receive ERS Aircraft Crash Charts TP 11183 from Transport Canada. They consist of two manuals containing charts for each aircraft and are available on request from the Transport Canada regional office.*

9.1.2 EMERGENCY OPERATIONS CENTRE AND COMMAND POST

Application

9.1.2.1 Recommendation.— At an International Airport, a fixed emergency operations centre and a mobile command post should be available for use during an emergency.

Characteristics

9.1.2.2 Recommendation.— The emergency operations centre should be a part of the aerodrome facilities and should be responsible for the overall coordination and general direction of the response to an emergency.

9.1.2.3 Recommendation.— The command post should be a facility capable of being moved rapidly to the site of an emergency, when required, and should undertake the local coordination of those agencies responding to the emergency.

9.1.2.4 Recommendation.— The aerodrome operator should assign a person to

assume control of the emergency operations centre and, when appropriate, another person the command post.

Communication system

9.1.2.5 Recommendation.— Adequate communication systems linking the command post and the emergency operations centre with each other and with the participating agencies should be provided in accordance with the plan and consistent with the particular requirements of the aerodrome.

9.1.3 AERODROME EMERGENCY EXERCISE

9.1.3.1 Recommendation.— The aerodrome emergency response plan should contain procedures for periodic testing of the adequacy of the plan and for reviewing the results in order to improve its effectiveness.

Note.— *The plan includes all participating agencies and associated resources.*

9.1.3.2 Recommendation.— Emergency exercises should be conducted during different seasons of the year to test the capabilities of all participating agencies and equipment under varying climatic conditions.

9.1.3.3 Recommendation.— The aerodrome emergency response plan should be tested by conducting:

- a) a full-scale aerodrome emergency exercise at intervals not exceeding three years; and
- b) partial emergency exercises in the intervening year to ensure that any deficiencies found during the full-scale aerodrome emergency exercise have been corrected; and

reviewed thereafter, or after an actual emergency, so as to correct any deficiency found during such exercises or actual emergency.

Note.— *The purpose of a full-scale exercise is to ensure the adequacy of the plan to cope with different types of emergencies. The purpose of a partial exercise is to ensure the adequacy of the response to individual participating agencies and components of the plan, such as the*

communications system.

9.2 NOT ALLOCATED

9.3 DISABLED AIRCRAFT REMOVAL

Introductory Note.— The Canadian Transportation Accident Investigation and Safety Board Act provides for protection of an aviation accident site, the aircraft, components, and contents. Where a disabled aircraft has been involved in an accident, permission to disturb the accident site must first be obtained from a Transportation Safety Board Inspector. Notwithstanding this rule, the aircraft may be moved where necessary to preserve life or to prevent additional hazard to persons or property.

9.3.1 DISABLED AIRCRAFT REMOVAL PLAN

Note.— Guidance on removal of a disabled aircraft, including recovery equipment, is given in the ICAO Airport Services Manual, Part 5 and Part 8, chapter 14.

Application

9.3.1.1 Recommendation.— A plan for the removal of an aircraft disabled on, or adjacent to, the movement area should be established for an aerodrome, and a coordinator designated to implement the plan, when necessary.

Note.— In determining the requirement for, and extent of a Disabled Aircraft Removal Plan factors to be considered include but are not limited to:

- a) *frequency of air traffic at the aerodrome;*
- b) *size and weight of aircraft using the aerodrome; and*
- c) *the physical characteristics of the aerodrome.*

Characteristics

9.3.1.2 Recommendation.— The disabled aircraft removal plan should be developed by the aerodrome operator in consultation with aircraft owners and operators.

9.3.1.3 Recommendation.— The disabled aircraft removal plan should be based on the characteristics of the aircraft that may normally be expected to operate at the aerodrome, and include among other things:

- a) a list of equipment and personnel on, or in the vicinity of, the aerodrome which would be available for such purpose;
- b) arrangements for the rapid receipt of aircraft recovery equipment kits available from other aerodromes;
- c) a list of nominated agents acting on behalf of each aircraft operator at the aerodrome;
- d) a statement of the aircraft operator arrangements for the use of pooled specialist equipment; and
- e) a list of local contractors (with contacts and telephone numbers) with suitable removal equipment for hire.

9.3.1.4 Recommendation.— All major users of the aerodrome should be informed of the preparations and capabilities contained within the disabled aircraft removal plan. The designated coordinator should be made known to all aircraft owners and operators.

9.3.2 REMOVAL OF DISABLED AIRCRAFT FROM OPERATIONAL AREAS

Note.— See introductory note at the beginning of this section

9.3.2.1 Standard.— Where a disabled aircraft is on a part of an aerodrome that interferes with the movement of other aircraft, the disabled aircraft shall be moved as quickly as is consistent with the safety of life and property.

Note.— A claim for damages could follow an attempt to move a crashed or disabled aircraft if it was proven the act of moving worsened the damage. It is important therefore, to allow only the aircraft owner, operator, or his appointed representative to control the aircraft removal operation.

9.4 MAINTENANCE

9.4.1 GENERAL

9.4.1.1 Standard.— A maintenance programme including preventive maintenance where appropriate shall be established at an aerodrome to maintain facilities in a condition which does not impair the safety, regularity or efficiency of air navigation.

Note 1.— Preventive maintenance is programmed maintenance work done in order to prevent a failure or degradation of facilities.

Note 2.— "Facilities" are intended to include, but are not limited to, such items as pavements, prepared surfaces, visual aids, fencing, drainage systems and buildings.

Note 3.— Guidance on the development of an airport self inspection program is contained in the TC Airports Safety Program Manual, TP 11465.

9.4.2 PAVEMENTS

9.4.2.1 Recommendation.— The surface of pavements (runways, taxiways, aprons, etc.) should be kept clear of any loose stones or other objects that might cause damage to aircraft structures or engines, or impair the operation of aircraft systems.

Note.— Guidance on precautions to be taken in regard to the surface of shoulders is given in:

- a) *the TC Operations and Maintenance Manual for Airport Pavements, TP 779; and,*
- b) *the ICAO Aerodrome Design Manual, Part 2.*

9.4.2.2 Recommendation.— The surface of a runway should be maintained in a condition such as to preclude formation of harmful irregularities.

9.4.2.3 Standard.— For a runway serving turbojet aeroplanes, measurements of the friction characteristics of a runway surface shall be made periodically with a continuous friction measuring device using self-wetting features.

9.4.2.4 Standard.— Corrective maintenance action shall be taken when:

- a) the average coefficient of friction for the entire runway is below 0.50; or
- b) any areas of a runway surface that are 100 metres or greater in length have an average coefficient of friction less than 0.30.

9.4.2.5 Standard.— Corrective maintenance action shall be programmed when:

- a) the average coefficient of friction for the entire runway is below 0.60; or
- b) any areas of a runway surface that are 100 metres or greater in length have an average coefficient of friction less than 0.50.

9.4.2.6 Recommendation.— When there is reason to believe that the drainage characteristics of a runway or portions thereof are poor due to slopes or depressions then the runway friction characteristics should be assessed under natural or simulated conditions that are representative of local rain and corrective maintenance action should be taken as necessary.

9.4.2.7 Recommendation.— When a taxiway is used by turbine-engined aeroplanes the surface of the taxiway shoulders should be maintained so as to be free of any loose stones or other objects that could be ingested by the aeroplane engines.

Note.— Guidance on the subject is given in the ICAO Aerodrome Design Manual, Part 2.

Winter maintenance

9.4.2.8 Recommendation.— The surface of a runway should be maintained in a condition so as to provide good friction characteristics and low rolling resistance. Snow, slush, ice, standing water

and other contaminants should be removed as rapidly and completely as possible to minimize accumulation.

Note.— Guidance on determining and expressing the friction characteristics on snow or ice contaminated runways is given in the Canadian Class 1 NOTAM Procedures Manual Chapter 9, TP 973. The Airports Winter Surface Maintenance Manual TP 659 contains further information on improving friction characteristics and on clearing of runways.

9.4.2.9 Recommendation.— A taxiway should be kept clear of snow, slush, ice, etc. to the extent necessary to enable aircraft to be taxied to and from an operational runway.

9.4.2.10 Recommendation.— Aprons should be kept clear of snow, slush, ice, etc. to the extent necessary to enable aircraft to manoeuvre safely or where appropriate to be towed or pushed.

9.4.2.11 Recommendation.— Whenever the clearance of snow, slush, ice, etc. from the various parts of the movement area cannot be carried out simultaneously the order of priority should be as follows but may be altered following consultation with the aerodrome users:

- 1st – runway(s) in use;
- 2nd – taxiways serving runway(s) in use;
- 3rd – apron(s);
- 4th – holding bays;
- 5th – emergency access roads; and
- 6th – other areas.

9.4.2.12 Recommendation.— Chemicals to remove or to prevent the formation of ice and frost on aerodrome pavements should be used when conditions indicate their use could be effective. Caution should be exercised in the application of the chemicals so as not to create a more slippery conditions.

Note.— Guidance on the use of ice control chemicals is given in the Airports Winter Maintenance Manual ,TP 659.

9.4.2.13 Standard.— Chemicals which may have harmful effects on aircraft or pavements, or chemicals which may have toxic effects on the aerodrome environment, shall not be used.

9.4.2.14 Standard.— Systematic reporting on the status of winter aerodrome maintenance shall be carried out in accordance with the RSC/JBI format contained in Chapter 9 of the Canadian Class 1 NOTAM Procedures Manual - TP 973.

Runway pavement overlays

Note.— The following specifications are intended for runway pavement overlay projects when the runway is to be returned to an operational status before overlay of the entire runway is complete thus normally necessitating a temporary ramp between the new and old runway surfaces. Guidance on overlaying pavements and assessing their operational status is given in the ICAO Aerodrome Design Manual, Part 3.

9.4.2.15 Standard.— The longitudinal slope of the temporary ramp shall not exceed 1.0 per cent measured with reference to the existing runway surface or previous overlay course.

9.4.2.16 Recommendation.— Overlaying should proceed from one end of the runway toward the other end so that based on runway utilization most aircraft operations will experience a down ramp.

9.4.2.17 Recommendation.— The entire width of the runway should be overlaid during each work session.

9.4.2.18 Standard.— Before a runway being overlaid is returned to a temporary operational status, a runway centre line marking conforming to the specifications in Section 5.2.3 shall be provided. Additionally, the location of any temporary threshold shall be identified by a 3.6 m wide transverse stripe.

Note.— See 5.2.4.8 to 5.2.4.10 for characteristics of a transverse stripe.

9.4.3 VISUAL AIDS

Note.— These specifications are not intended to define the failure of a lighting system.

Application

9.4.3.1 Standard.— A system of preventive maintenance of visual aids shall be employed to ensure lighting and marking system reliability.

Note.— Guidance on preventive maintenance of visual aids is given in the ICAO Airport Services Manual, Part 9.

9.4.3.2 Recommendation.— The system of preventive maintenance employed for a precision approach runway category II or III should have as its objective that, during any period of category II or III operations, all approach and runway lights are serviceable, and that in any event at least:

- a) 95 per cent of the lights are serviceable in each of the following particular significant elements:
 - precision approach category II and III lighting system, the inner 450 m;
 - runway centre line lights;
 - runway threshold lights; and
 - runway edge lights;
- b) 90 per cent of the lights are serviceable in the touchdown zone lights;
- c) 85 per cent of the lights are serviceable in the approach lighting system beyond 450 m; and
- d) 75 per cent of the lights are serviceable in the runway end lights.

9.4.3.3 Recommendation.— In order to provide continuity of guidance, the allowable percentage of unserviceable lights in a system listed in 9.4.3.2, should not be permitted in such a way as to alter the basic pattern of the lighting system. Additionally, an unserviceable light should not be permitted adjacent to another unserviceable light, except in a barrette or a crossbar where two adjacent unserviceable lights may be permitted.

Note.— With respect to barrettes, crossbars and runway edge lights, lights are considered to be adjacent if located consecutively and:

- laterally: in the same barrette or crossbar; or
- longitudinally: in the same row of edge lights or barrettes.

9.4.3.4 Recommendation.— The system of preventive maintenance employed for a stop bar provided at a taxi holding position used in conjunction with a runway intended for operations in runway visual range conditions less than a value of the order of 1400 ft (400 m) should have the following objectives:

- a) no more than two lights will remain unserviceable; and
- b) two adjacent lights will not remain unserviceable unless the light spacing is significantly less than that specified.

9.4.3.5 Recommendation.— The system of preventive maintenance employed for a taxiway intended for use in runway visual range conditions less than a value of the order of 1400 ft (400 m) should have as its objective that no two adjacent taxiway centre line lights be unserviceable.

9.4.3.6 Recommendation.— The system of preventive maintenance employed for a precision approach runway category I should have as its objective that, during any period of category I operations, all approach and runway lights are serviceable, and that in any event at least 85 per cent of the lights are serviceable in each of the following:

- a) precision approach category I lighting system;
- b) runway threshold lights;
- c) runway edge lights; and
- d) runway end lights.

9.4.3.7 Recommendation.— In order to provide continuity of guidance, an unserviceable light in a system listed in 9.4.3.6, should not be permitted adjacent to another unserviceable light unless the light spacing is significantly less than that specified.

9.4.3.8 Recommendation.— The system of preventive maintenance employed for a runway intended for take-off in runway visual range conditions less than a value of 1400 ft (400 m) should have as its objective that all runway lights are serviceable, and that in any event at least:

- a) 95 per cent of the lights are serviceable in each of the following particular significant elements:
 - runway centre line lights;
 - runway threshold lights; and
 - runway edge lights; and
- b) 75 per cent of the lights are serviceable in the runway end lights.

9.4.3.9 Recommendation.— In order to provide continuity of guidance, the allowable percentage of unserviceable lights in a system listed in 9.4.3.8, should not be permitted in such a way as to alter the basic pattern of the lighting system. Additionally, an unserviceable light should not be permitted adjacent to another unserviceable light.

Note.— *With respect to runway edge lights, lights are considered to be adjacent if located sequentially in the same row of edge lights.*

9.5 WILDLIFE HAZARD REDUCTION

9.5.1 GENERAL

9.5.1.1 Recommendation.— The bird strike hazard on, or in the vicinity of, an aerodrome should be assessed through the collection of information from aircraft operators, airport personnel, etc. on the presence of birds on or around the aerodrome.

9.5.1.2 Recommendation.— When a bird strike hazard is identified at an aerodrome, the aerodrome operator should take action to decrease the number of birds constituting a potential hazard to aircraft operations by adopting measures for discouraging their presence on, or in the vicinity of, an aerodrome.

Note.— *Guidance on effective measures for establishing whether or not birds, on or near an aerodrome, constitute a potential hazard to aircraft operations, and on methods for discouraging their presence, is given in:*

- a) *Wildlife control procedures, TP 11500; and*
- b) *the ICAO Airport Services Manual, Part 3.*

9.5.1.3 Recommendation.— Garbage disposal dumps or any such other source attracting bird activity on, or in the vicinity of, an aerodrome should be eliminated or their establishment prevented, unless an aeronautical study indicates that they are unlikely to create conditions conducive to a bird hazard problem.

Note.— *Guidance on land uses which may attract birds and be hazardous to aircraft operations is contained in the Land Use in the Vicinity of Airports Manual, TP 1247.*

9.6 APRON MANAGEMENT SERVICE

9.6.1 GENERAL

9.6.1.1 Recommendation.— When warranted by the volume of traffic and operating conditions, an appropriate apron management service should be provided on an apron by an ATS unit, by another aerodrome operating authority, jointly by ATS and the aerodrome operator, or operator in the case of a company terminal, in order to:

- a) regulate movement with the objective of preventing collisions between aircraft, and between aircraft and obstacles;
- b) regulate entry of aircraft into, and coordinate exit of aircraft from, the apron with the aerodrome control tower; and
- c) ensure safe and expeditious movement of vehicles and appropriate regulation of other activities.

9.6.1.2 Recommendation.— When the aerodrome control tower does not participate in the apron management service, procedures should be established to facilitate the orderly transition of aircraft between the apron management unit and the aerodrome control tower.

Note.— *Guidance on an apron management service is given in the;*

- a) *ICAO Airport Services Manual, Part 8; and*
- b) *ICAO Manual of Surface Movement Guidance and Control Systems (SMGCS).*

9.6.1.3 Standard.— An apron management service shall be provided with radiotelephony communications facilities.

9.6.1.4 Standard.— Where low visibility procedures are in effect, persons and vehicles operating on an apron shall be restricted to the essential minimum.

Note.— *Guidance on related special procedures is given in the ICAO Manual of Surface Movement Guidance and Control Systems (SMGCS).*

9.6.1.5 Standard.— An emergency vehicle responding to an emergency shall be given priority over all other surface movement traffic.

9.6.1.6 Standard.— A vehicle operating on an apron shall:

- a) give way to an emergency vehicle; an aircraft taxiing, about to taxi, or being pushed or towed; and
- b) give way to other vehicles in accordance with local regulations.

9.6.1.7 Standard.— An aircraft stand shall be visually monitored to ensure that the recommended clearances distances are provided to an aircraft using the stand.

9.7 GROUND SERVICING OF AIRCRAFT

9.7.1 GENERAL

9.7.1.1 Standard.— Fire extinguishing equipment suitable for at least initial intervention in the event of a fuel fire and personnel trained in its use shall be readily available during the ground servicing of an aircraft, and there shall be a means of quickly summoning the emergency response service in the event of a fire or major fuel spill.

9.7.1.2 Standard.— When aircraft refuelling operations take place while passengers are embarking, on board or disembarking, ground equipment shall be positioned so as to allow:

- a) the use of a sufficient number of exits for expeditious evacuation; and
- b) a ready escape route from each of the exits to be used in an emergency.

APPENDIX A. AERONAUTICAL GROUND LIGHT AND SURFACE MARKING COLOURS

To be issued at a later date

APPENDIX B. AERONAUTICAL GROUND LIGHT CHARACTERISTICS

B.1 APPROACH AND RUNWAY LIGHTS

B.1.1 APPROACH CENTRE LINE LIGHTS AND CROSSBARS

B.1.1.1 Standard.— The light distribution and intensity for a light unit located on the centre line or cross bar of a precision approach category I or precision approach category II and III approach lighting system shall be as illustrated in Figure B-1.

B.1.1.2 Standard.— The ratio between the average intensity within the ellipse defining the main beam depicted in Figure B-1 and the average light intensity of the main beam of a new runway edge light shall be from 1.5 to 2.0.

Note.— Where inset lights are used in lieu of elevated lights (eg. on a runway with a displaced threshold), the intensity requirements can be met by installing two or three fittings (lower intensity) at each position.

B.1.1.3 Standard.— The measurement of intensity and alignment shall be in accordance with B.1.12.

**Figure B-1. Isocandela diagram for approach centre line lights and crossbars
(white light)**

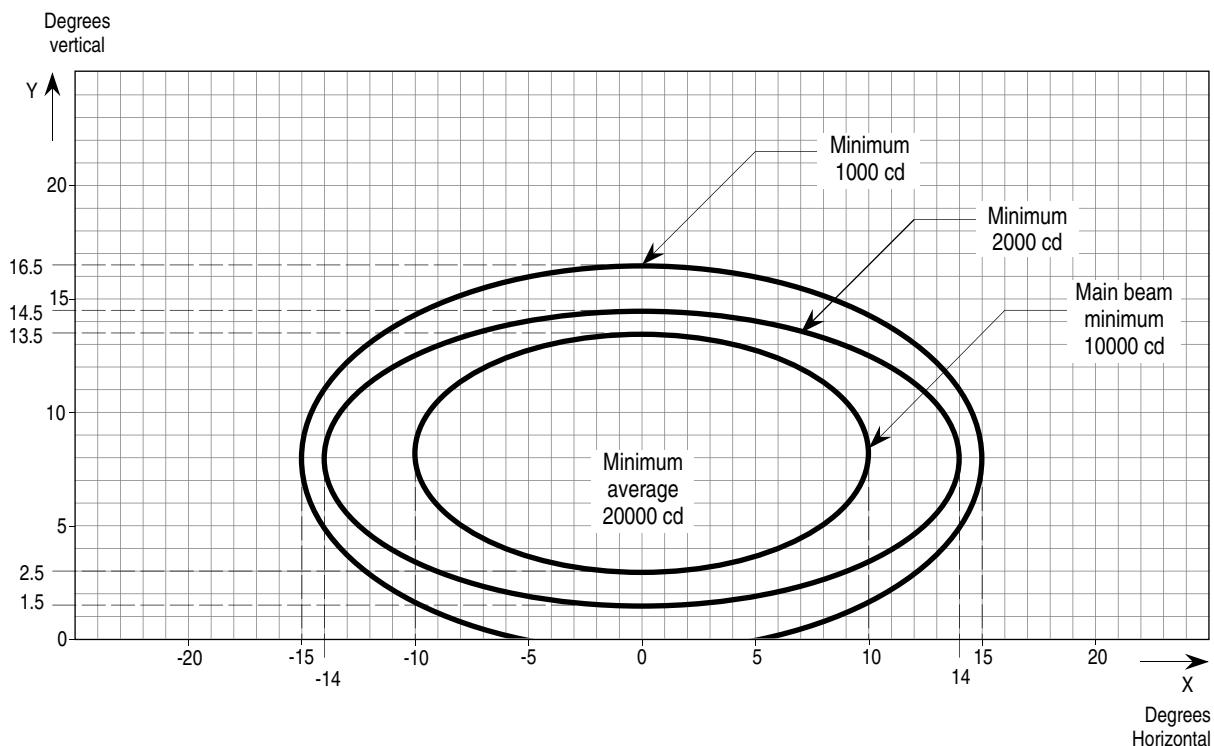

B.1.2 APPROACH SIDE ROW LIGHTS

B.1.2.1 Standard.— The light distribution and intensity for a light unit located on the side row of a precision approach category I or precision approach category II and III approach lighting system shall be as illustrated in Figure B-2.

B.1.2.2 Standard.— The ratio between the average intensity within the ellipse defining the main beam depicted in Figure B-2 and the average light intensity of the main beam of a new runway edge light shall be from 1.0 to 1.5.

Note.— Where inset lights are used in lieu of elevated lights (eg. on a runway with a displaced threshold), the intensity requirements can be met by installing two or three fittings (lower intensity) at each position.

B.1.2.3 Standard.— The measurement of intensity and alignment shall be in accordance with B.1.12.

Figure B-2. Isocandela diagram for approach side row light (red light).

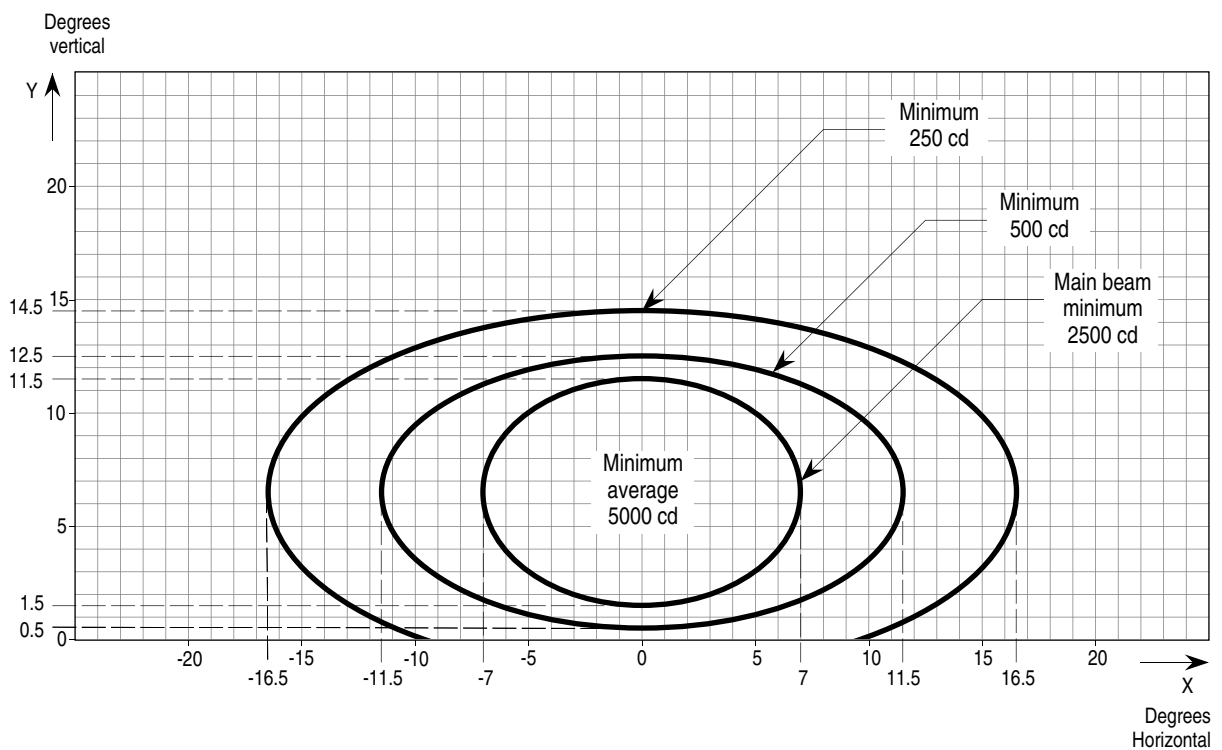

B.1.3 THRESHOLD LIGHTS

B.1.3.1 Standard.— The light distribution and intensity for a light unit located on the threshold bar shall be as illustrated in Figure B-3.

B.1.3.2 Standard.— The ratio between the average intensity within the ellipse defining the main beam depicted in Figure B-3 and the average light intensity of the main beam of a new runway edge light shall be from 1.0 to 1.5.

B.1.3.3 Standard.— The measurement of intensity and alignment shall be in accordance with B.1.12.

Figure B-3. Isocandela diagram for threshold light (green light)

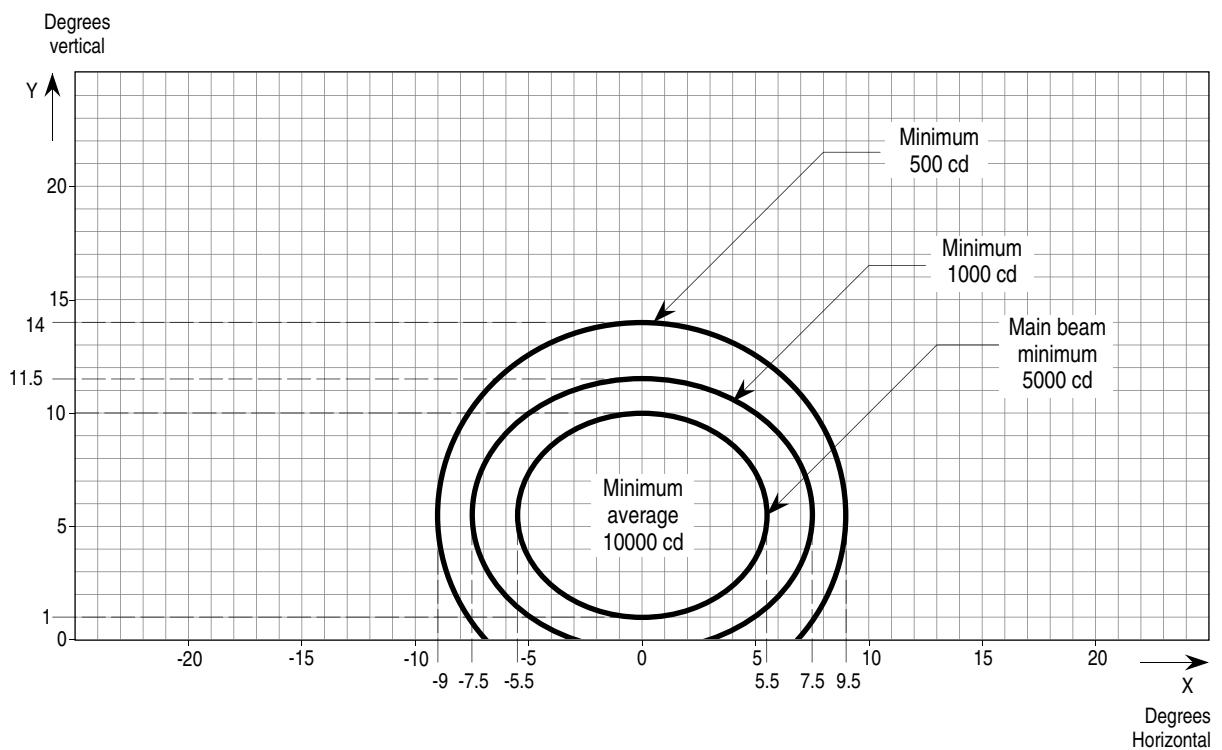

B.1.4 WING BAR LIGHTS

B.1.4.1 Standard.— The light distribution and intensity for a light unit located on a wing bar of a precision approach category II and III approach lighting system or used to indicate a displaced threshold shall be as illustrated in Figure B-4.

B.1.4.2 Standard.— The ratio between the average intensity within the ellipse defining the main beam depicted in Figure B-4 and the average light intensity of the main beam of a new runway edge light shall be from 1.0 to 1.5.

B.1.4.3 Standard.— The measurement of intensity and alignment shall be in accordance with B.1.12.

Figure B-4. Isocandela diagram for wing bar light (green light)

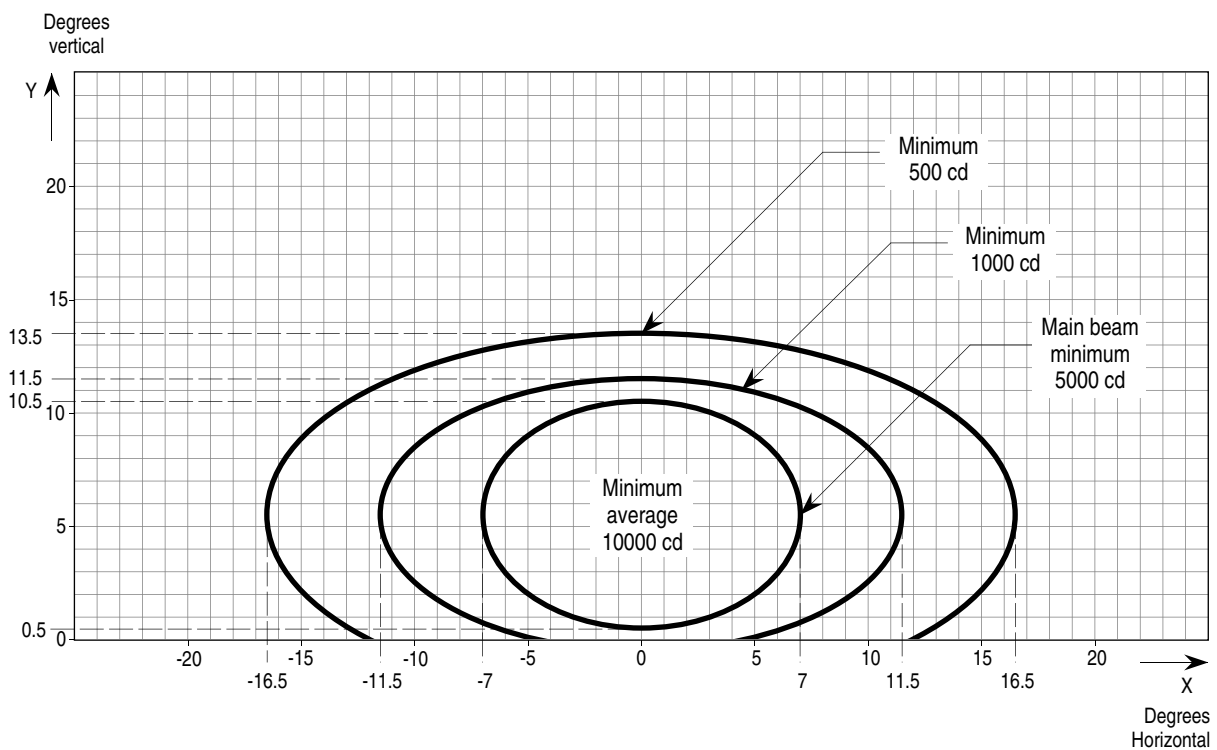

B.1.5 TOUCHDOWN ZONE LIGHTS

B.1.5.1 Standard.— The light distribution and intensity for a touchdown zone light unit shall be as illustrated in Figure B-5.

B.1.5.2 Standard.— The ratio between the average intensity within the ellipse defining the main beam depicted in Figure B-5 and the average light intensity of the main beam of a new runway edge light shall be from 0.5 to 1.0.

B.1.5.3 Standard.— The measurement of intensity and alignment shall be in accordance with B.1.12.

B.1.5.4 Standard.— The touchdown zone lights shall be installed with a toe-in of 4 degrees.

Figure B-5. Isocandela diagram for touchdown zone light (white light)

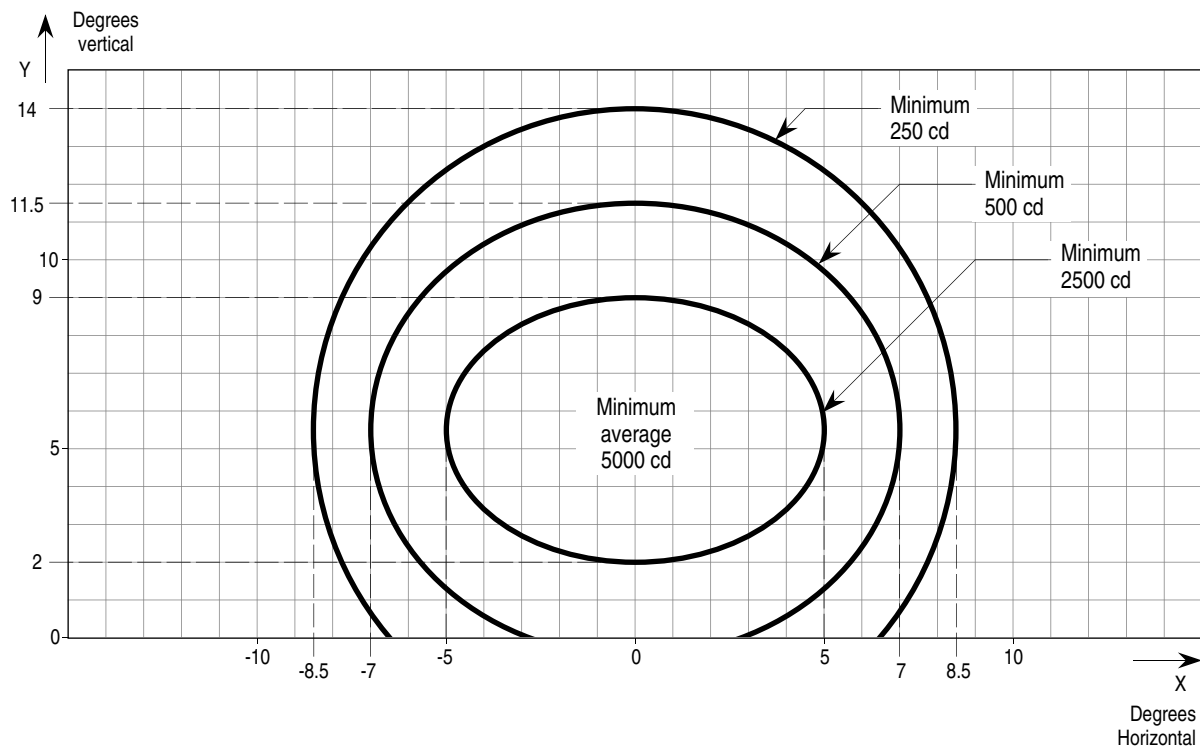

B.1.6 RUNWAY CENTRE LINE LIGHTS (30 m spacing)

B.1.6.1 Standard.— The light distribution and intensity for a runway centre line light unit installed with 30 m spacing shall be as illustrated in Figure B-6.

B.1.6.2 Standard.— The ratio between the average intensity within the ellipse defining the main beam depicted in Figure B-6 and the average light intensity of the main beam of a new runway edge light shall be from 0.5 to 1.0.

B.1.6.3 Standard.— The measurement of intensity and alignment shall be in accordance with B.1.12.

B.1.6.4 Standard.— Where red runway centre line lights are installed, the values for white light multiplied by 0.15 shall be used.

Figure B-6. Isocandela diagram for runway centre line light with 30 m longitudinal spacing (white light)

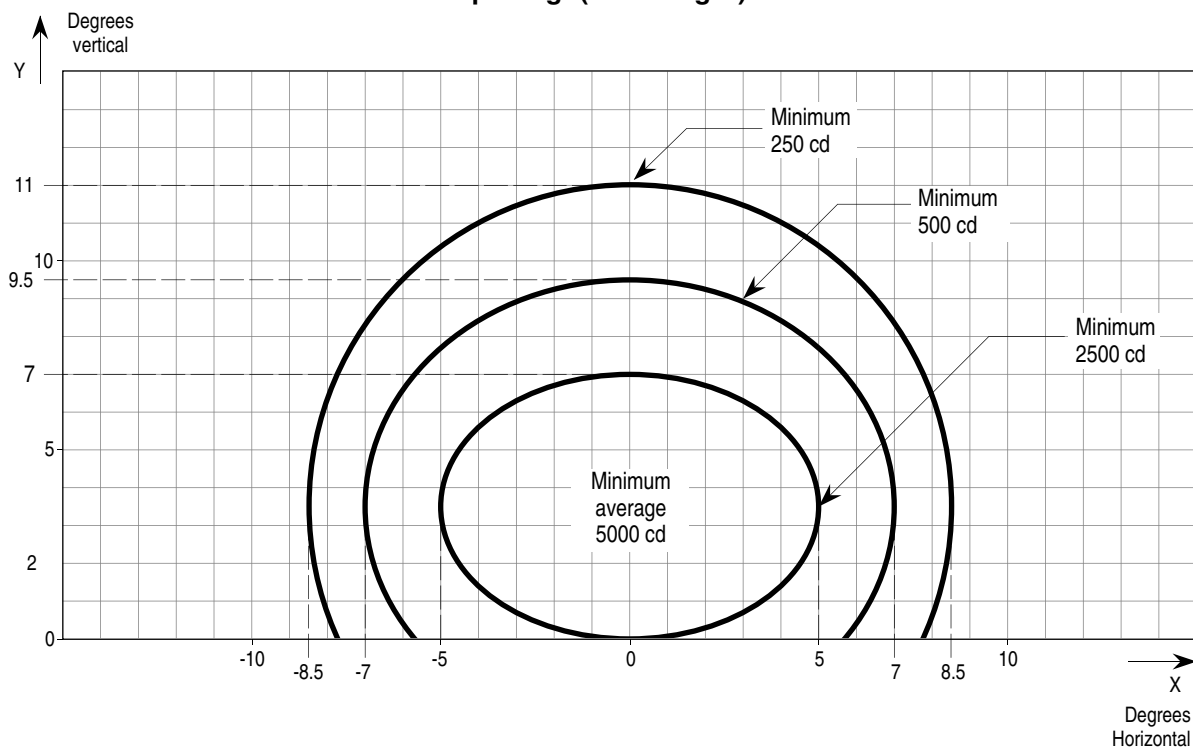

B.1.7 RUNWAY CENTRE LINE LIGHTS (15 m spacing)

B.1.7.1 Standard.— The light distribution and intensity for a runway centre line light unit installed with 15 m spacing shall be as illustrated in Figure B-7..

B.1.7.2 Standard.— The ratio between the average intensity within the ellipse defining the main beam depicted in Figure B-7 and the average light intensity of the main beam of a new runway edge light shall be from 0.5 to 1.0 for lights used on a precision approach runway category III and from 0.25 to 0.5 for lights used on a precision approach runway category I or category II.

B.1.7.3 Standard.— The measurement of intensity and alignment shall be in accordance with B.1.12.

B.1.7.4 Standard.— Where red runway centre line lights are installed, the values for white light multiplied by 0.15 shall be used.

Figure B-7. Isocandela diagram for runway centre line light with 15 m longitudinal spacing (white light)

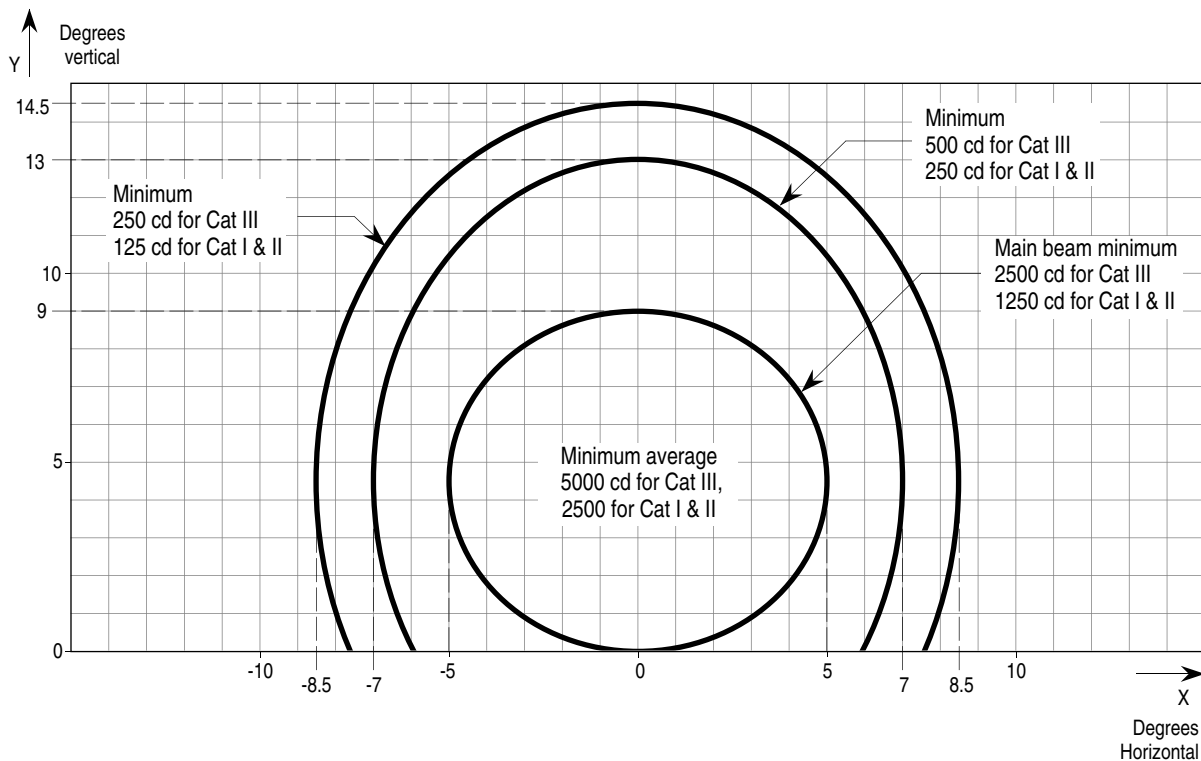

B.1.8 RUNWAY CENTRE LINE LIGHTS (7.5 m spacing)

B.1.8.1 Standard.— The light distribution and intensity for a runway centre line light unit installed with 7.5 m spacing shall be as illustrated in Figure B-8.

B.1.8.2 Standard.— The ratio between the average intensity within the ellipse defining the main beam depicted in Figure B-8 and the average light intensity of the main beam of a new runway edge light shall be from 0.12 to 0.25.

B.1.8.3 Standard.— The measurement of intensity and alignment shall be in accordance with B.1.12.

B.1.8.4 Standard.— Where red runway centre line lights are installed, the values for white light multiplied by 0.15 shall be used.

Figure B-8. Isocandela diagram for runway centre line light with 7.5 longitudinal spacing (white light)

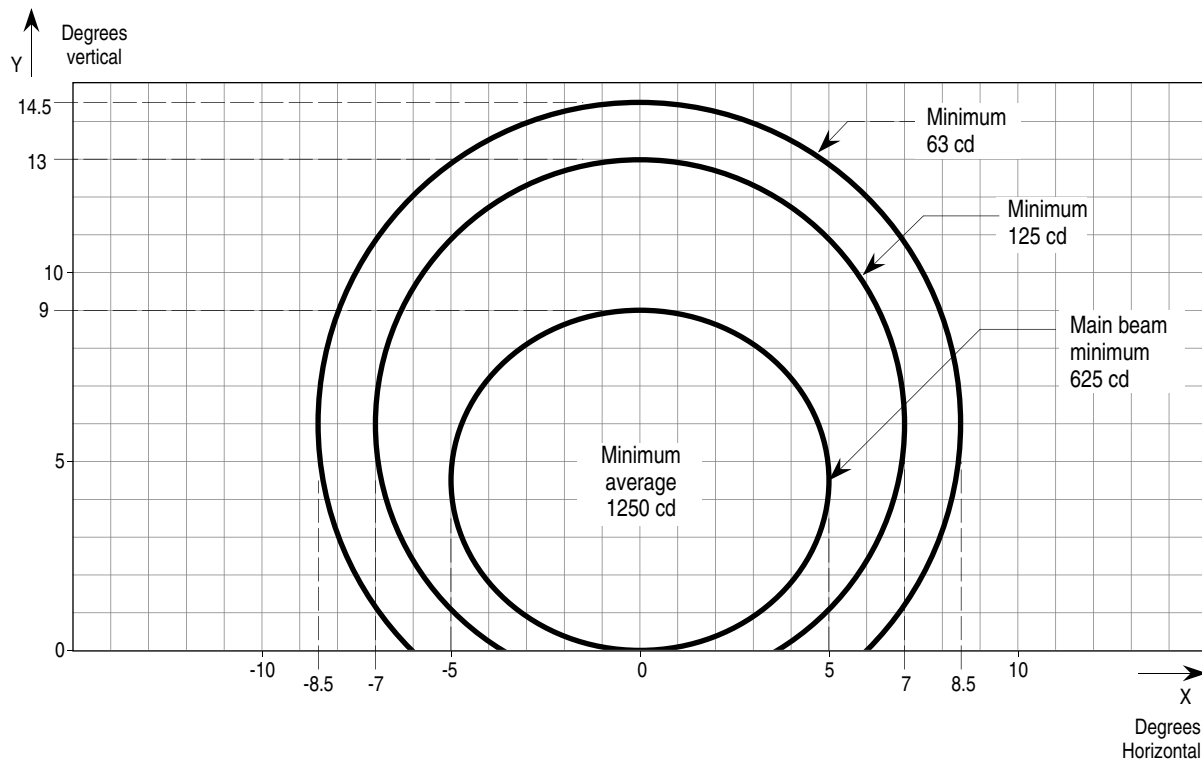

B.1.9 RUNWAY END LIGHTS

B.1.9.1 Standard.— The light distribution and intensity for a runway end light unit shall be as illustrated in Figure B-9.

B.1.9.2 Standard.— The ratio between the average intensity within the ellipse defining the main beam depicted in Figure B-9 and the average light intensity of the main beam of a new runway edge light shall be from 0.25 to 0.5.

B.1.9.3 Standard.— The measurement of intensity and alignment shall be in accordance with B.1.12.

Figure B-9. Isocandela diagram for runway end light (red light)

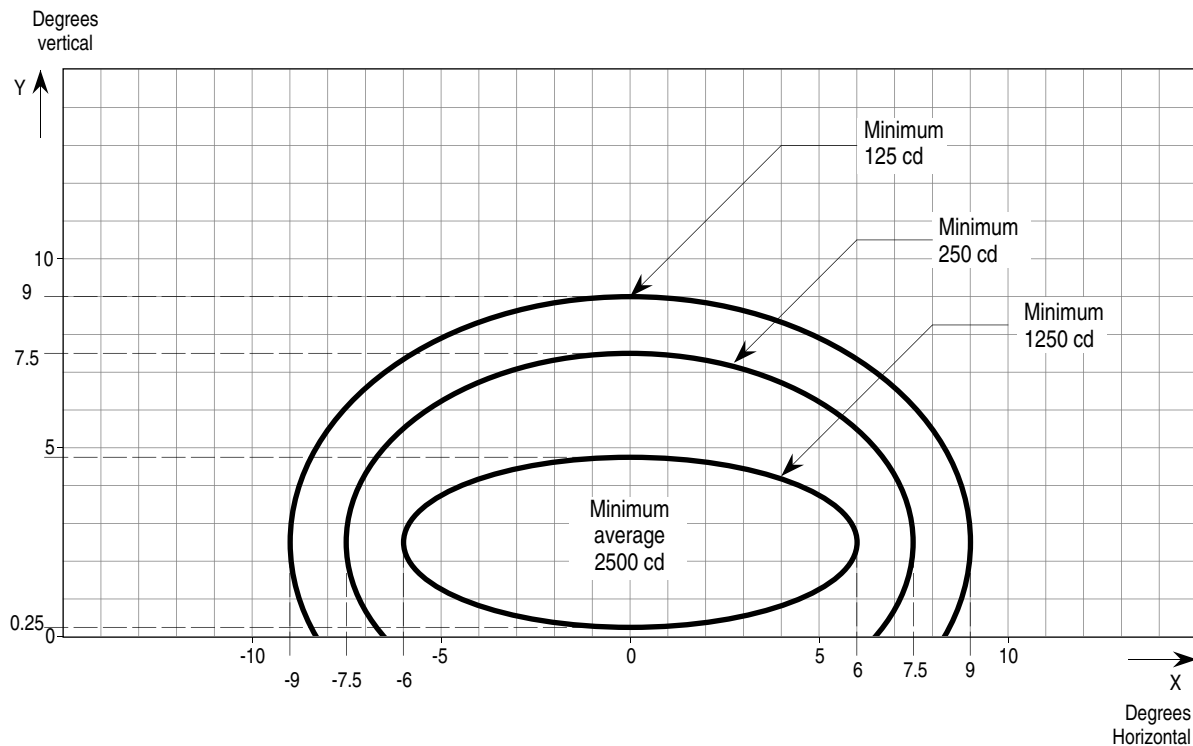

B.1.10 RUNWAY EDGE LIGHTS (45 m runway width)

B.1.10.1 Standard.— The light distribution and intensity for a runway edge light unit installed where the runway width is 45 m shall be as illustrated in Figure B-10.

B.1.10.2 Standard.— The ratio between the average intensity within the ellipse defining the main beam depicted in Figure B-10 and the average light intensity of the main beam of a new runway edge light shall be 1.0.

B.1.10.3 Standard.— The measurement of intensity and alignment shall be in accordance with B.1.12.

Figure B-10. Isocandela diagram for runway edge light where the width of the runway is 45 m (white light)

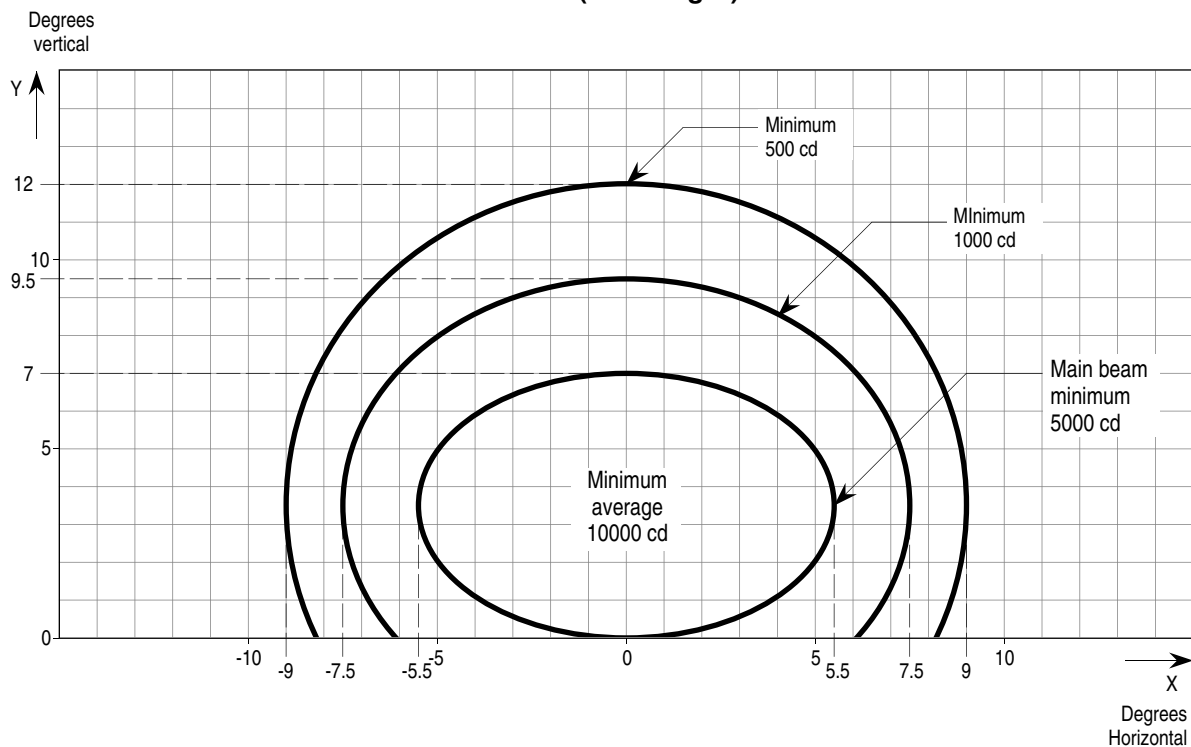

B.1.11 RUNWAY EDGE LIGHTS (60 m runway width)

B.1.11.1 Standard.— The light distribution and intensity for a runway edge light unit installed where the runway width is 60 m shall be as illustrated in Figure B-11.

B.1.11.2 Standard.— The ratio between the average intensity within the ellipse defining the main beam depicted in Figure B-11 and the average light intensity of the main beam of a new runway edge light shall be 1.0.

B.1.11.3 Standard.— The measurement of intensity and alignment shall be in accordance with B.1.12.

Figure B-11. Isocandela diagram for runway edge light where width of runway is 60 m (white light)

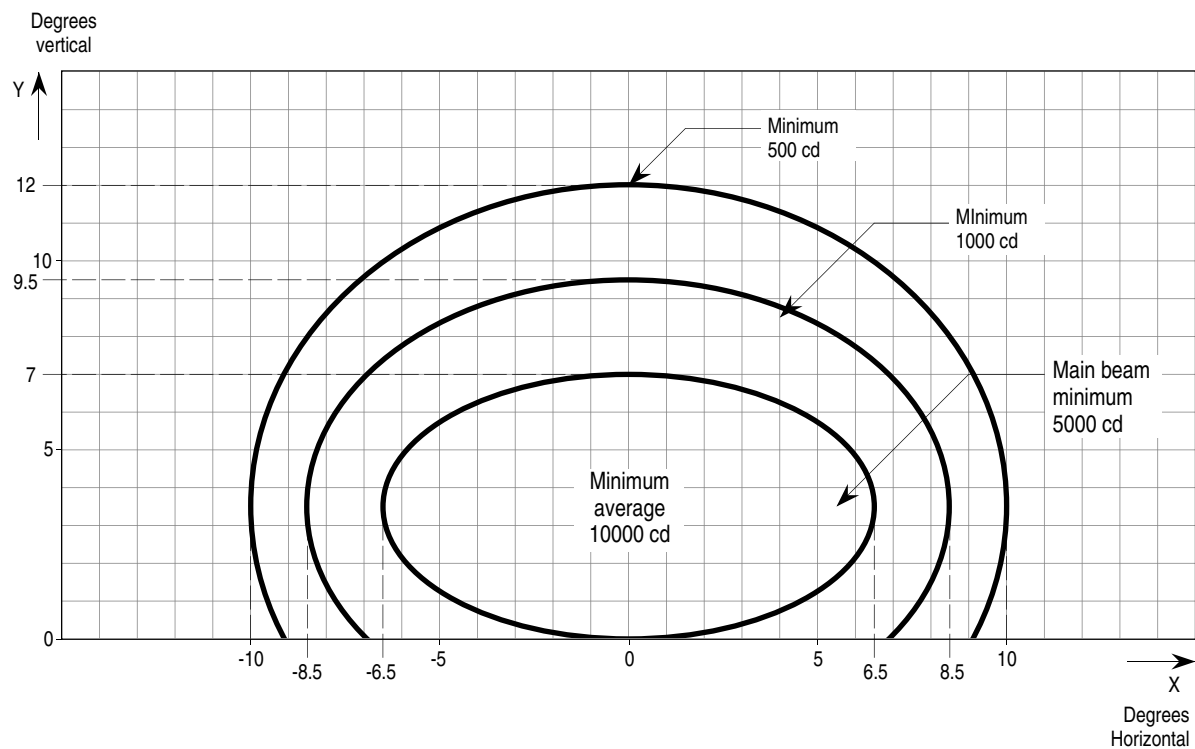

B.1.12 COLLECTIVE REQUIREMENTS FOR APPROACH AND RUNWAY LIGHTS

B.1.12.1 Standard.— The average intensity of the main beam of an approach or runway light (sections B.1.1 to B.1.11) shall be calculated by establishing grid points as shown in Figure B-12 and using the intensity values measured at all grid points located within and on the perimeter of the ellipse representing the main beam. The average value shall be the arithmetic average of light intensities measured at all considered grid points.

B.1.12.2 Standard.— Horizontal angles shall be measured with respect to the vertical plane through the runway centre line. For lights other than centre line lights, the direction towards the runway centre line shall be considered positive. Vertical angles shall be measured with respect to the horizontal plane.

B.1.12.3 Standard.— Approach and runway light units shall be installed so that the main beam is aligned within one-half degree of the specified requirement.

B.1.12.4 Standard.— Deviations in the main beam pattern shall not be acceptable when the lighting fixture is properly aimed.

Figure B-12. Grid points to be used for the calculation of average intensity of approach and runway lights

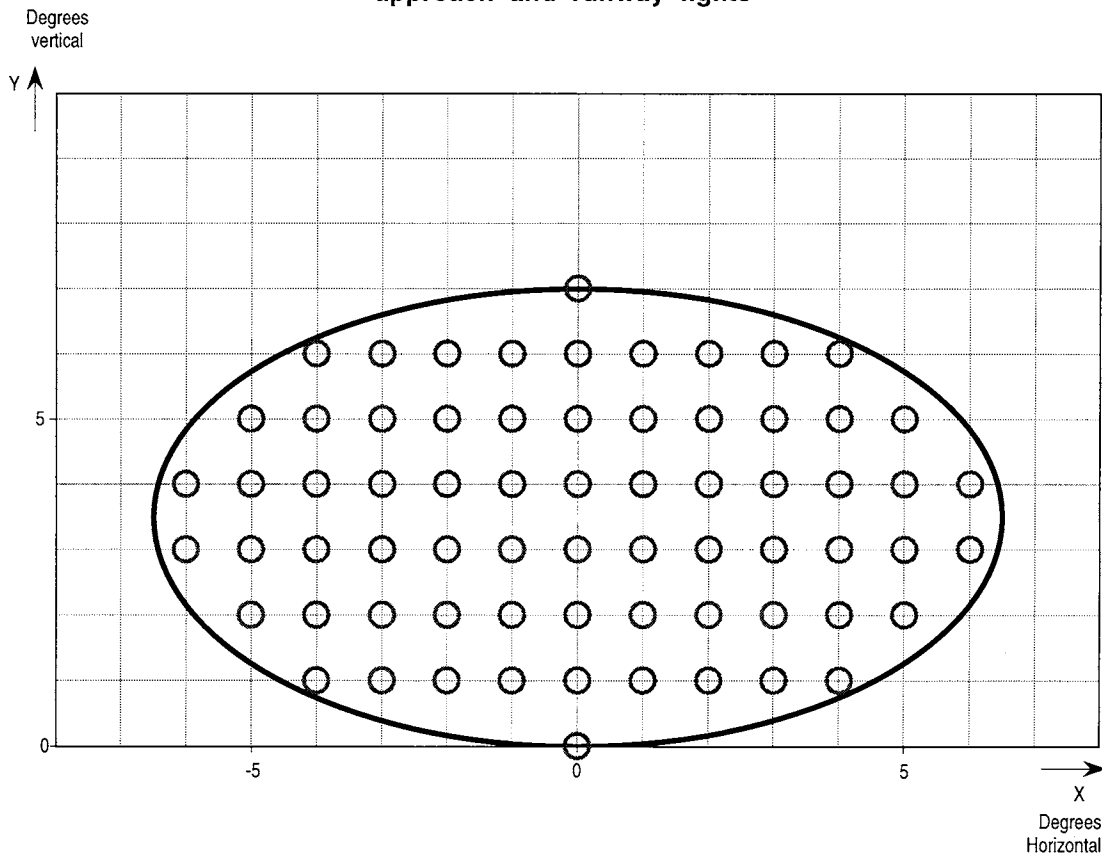

Note.— The ellipses outlining the beam dimensions and intensities in Figures B-1 to B-11 are symmetrical about the common vertical and horizontal axes. The actual boundaries of the ellipses are calculated on the formula:

$$\frac{x^2}{a^2} + \frac{y^2}{b^2} = 1$$

The values of “a” and “b” for the inner, middle, and outer ellipses shown in Figures B-1 to B-11 are tabulated in Table B-1.

Table B-1. Dimensions of ellipses defining isocandela boundaries for Figures B-1 to B-11

LIGHT UNIT	REFERENCE FIGURE	Value of “a”			Value of “b”		
		inner	middle	outer	inner	middle	outer
(1)	(2)	(3)	(4)	(5)	(6)	(7)	(8)
Approach centre line and crossbars	Figure B-1	10	14	15	5.5	6.5	8.5
Approach side row	Figure B-2	7.0	11.5	16.5	5.0	6.0	8.0
Threshold	Figure B-3	5.5	7.5	9.0	4.5	6.0	8.5
Wing bar	Figure B-4	7.0	11.5	16.5	5.0	6.0	8.0
Touchdown zone	Figure B-5	5.0	7.0	8.5	3.5	6.0	8.5
Runway centre line (30 m spacing)	Figure B-6	5.0	7.0	8.5	3.5	6.0	8.5
Runway centre line (15 m spacing)	Figure B-7	5.0	7.0	8.5	4.5	8.5	10
Runway centre line (7.5 m spacing)	Figure B-8	5.0	7.0	8.5	4.5	8.5	10
Runway end	Figure B-9	6.0	7.5	9.0	2.25	5.0	6.5
Runway edge (45 m runway width)	Figure B-10	5.5	7.5	9.0	3.5	6.0	8.5
Runway edge (60 m runway width)	Figure B-11	6.5	8.5	10.0	3.5	6.0	8.5

B.2 TAXIWAY LIGHTS

B.2.1 TAXIWAY CENTRE LINE LIGHTS (15 m spacing) and STOP BAR LIGHTS IN STRAIGHT SECTIONS INTENDED FOR USE IN RVR CONDITIONS LESS THAN A VALUE OF 1400 FT (large offsets)

B.2.1.1 Standard.— The average intensity of the main beam of a taxiway centre line light spaced at longitudinal intervals of 15 m or a stop bar light intended for use on straight sections in runway visual range conditions less than a value in the order of 1400 ft (400 m) and, where a large offset can occur between the cockpit of an aircraft and the light units shall be as illustrated in Figure B-13.

Note.— The beam coverages depicted in Figure B-13 allow for displacement of the cockpit from the centre line up to distances of the order of 12 m and are intended for use before and after curves.

B.2.1.2 Standard.— The measurement of intensity and alignment shall be in accordance with B.2.7.

Figure B-13. Isocandela diagram for taxiway centre line (15 m spacing) and stop bar lights in straight sections intended for use in runway visual range conditions of less than a value of the order of 1400 ft (400 m) where large offsets can occur

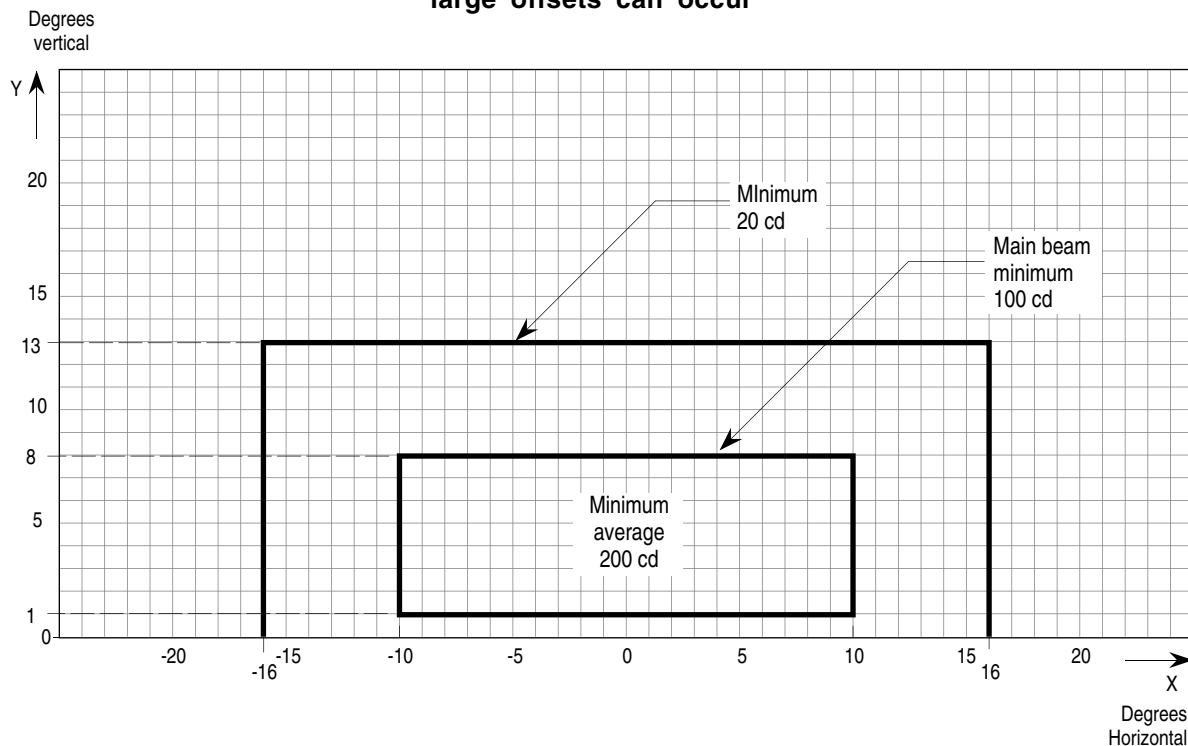

B.2.2 TAXIWAY CENTRE LINE LIGHTS (15 m spacing) and STOP BAR LIGHTS IN STRAIGHT SECTIONS INTENDED FOR USE IN RVR CONDITIONS LESS THAN A VALUE OF 1400 FT

B.2.2.1 Standard.— The average intensity of the main beam of a taxiway centre line light spaced at longitudinal interval of 15 m or a stop bar light intended for use on straight sections in runway visual range conditions less than a value in the order of 1400 ft (400 m) shall be as illustrated in Figure B-14.

Note.— The beam coverages depicted in Figure B-14 are generally satisfactory and cater for a normal displacement of the cockpit from the centre line of approximately 3 m.

B.2.2.2 Standard.— The measurement of intensity and alignment shall be in accordance with B.2.7.

Figure B-14. Isocandela diagram for taxiway centre line (15 m spacing) and stop bar lights in straight sections intended for use in runway visual range conditions of less than a value of the order of 1400 ft (400 m)

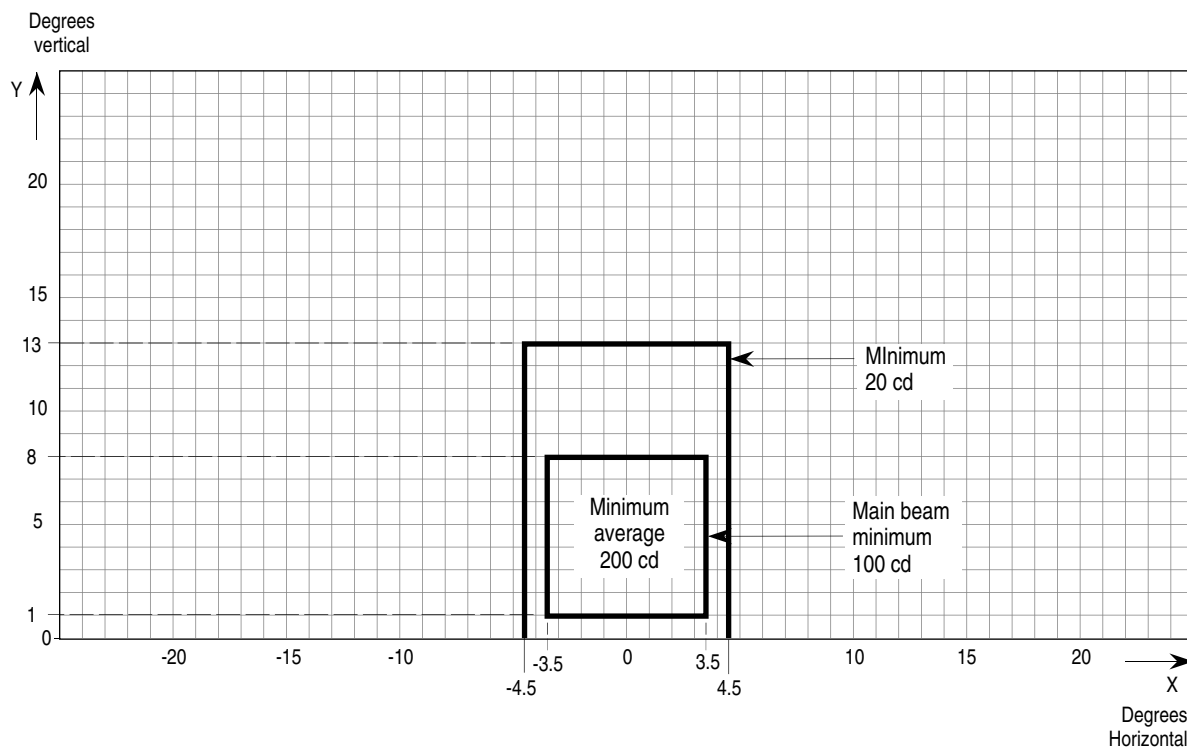

B.2.3 TAXIWAY CENTRE LINE LIGHTS (7.5 m spacing) and STOP BAR LIGHTS IN CURVED SECTIONS INTENDED FOR USE IN RVR CONDITIONS LESS THAN A VALUE OF 1400 FT

B.2.3.1 Standard.— The average intensity of the main beam of a taxiway centre line light spaced at longitudinal intervals of 7.5 m or a stop bar light intended for use on curved sections in runway visual range conditions less than a value in the order of 1400 ft (400 m) shall be as illustrated in Figure B-15.

B.2.3.2 Standard.— Where the light units are installed on curved sections, they shall be toed-in 15.75 degrees with respect to the tangent of the curve.

B.2.3.3 Standard.— The measurement of intensity and alignment shall be in accordance with B.2.7.

Figure B-15. Isocandela diagram for taxiway centre line (7.5 m spacing) and stop bar lights in curved sections intended for use in runway visual range conditions of less than a value of the order of 1400 ft (400 m)

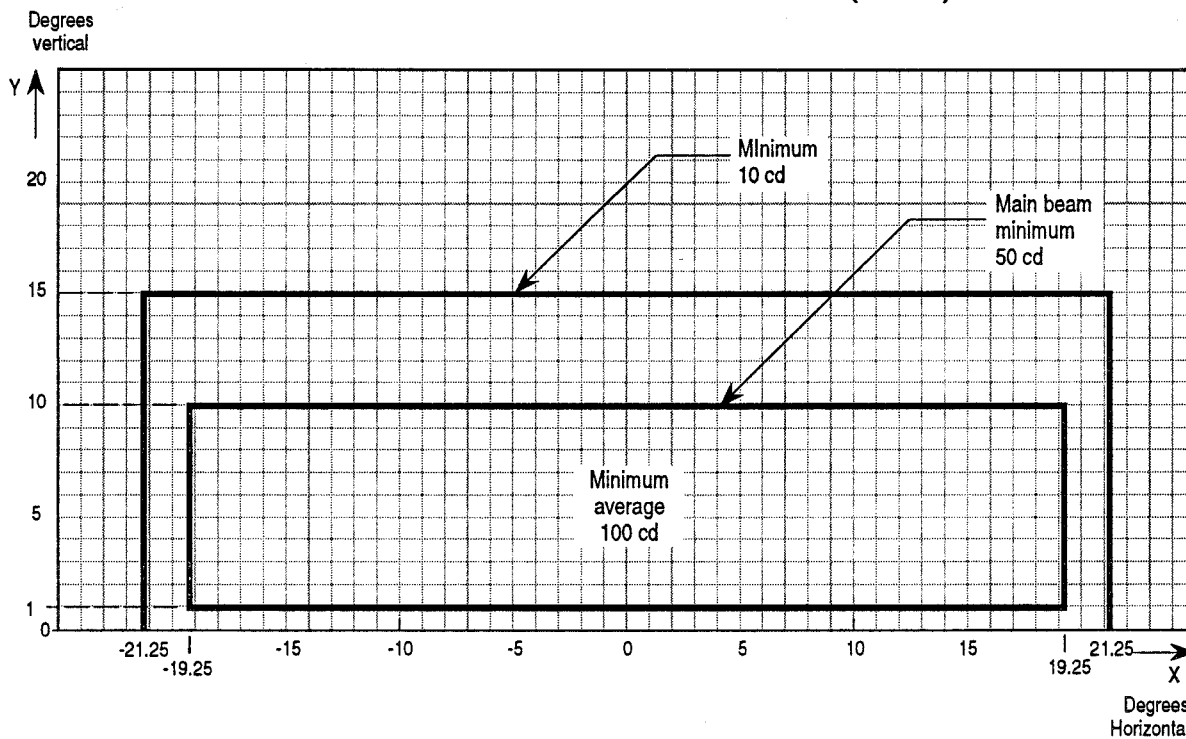

B.2.4 TAXIWAY CENTRE LINE LIGHTS (30 m, 60 m spacing) and STOP BAR LIGHTS IN STRAIGHT SECTIONS INTENDED FOR USE IN RVR CONDITIONS OF 1400 FT OR GREATER

B.2.4.1 Standard.— The average intensity of the main beam of a taxiway centre line light spaced at longitudinal intervals of 30 m or 60 m or a stop bar light intended for use on straight sections in runway visual range conditions in the order of 1400 ft (400 m) or greater, shall be as illustrated in Figure B-16.

B.2.4.2 Standard.— Where the light units are omnidirectional, they shall comply with the vertical beam requirements of Figure B-16.

B.2.4.3 Standard.— The measurement of intensity and alignment shall be in accordance with B.2.7.

Figure B-16. Isocandela diagram for taxiway centre line (30 m and 60 m spacing) and stop bar lights in straight sections intended for use in runway visual range conditions of the order of 1400 ft (400 m) or greater

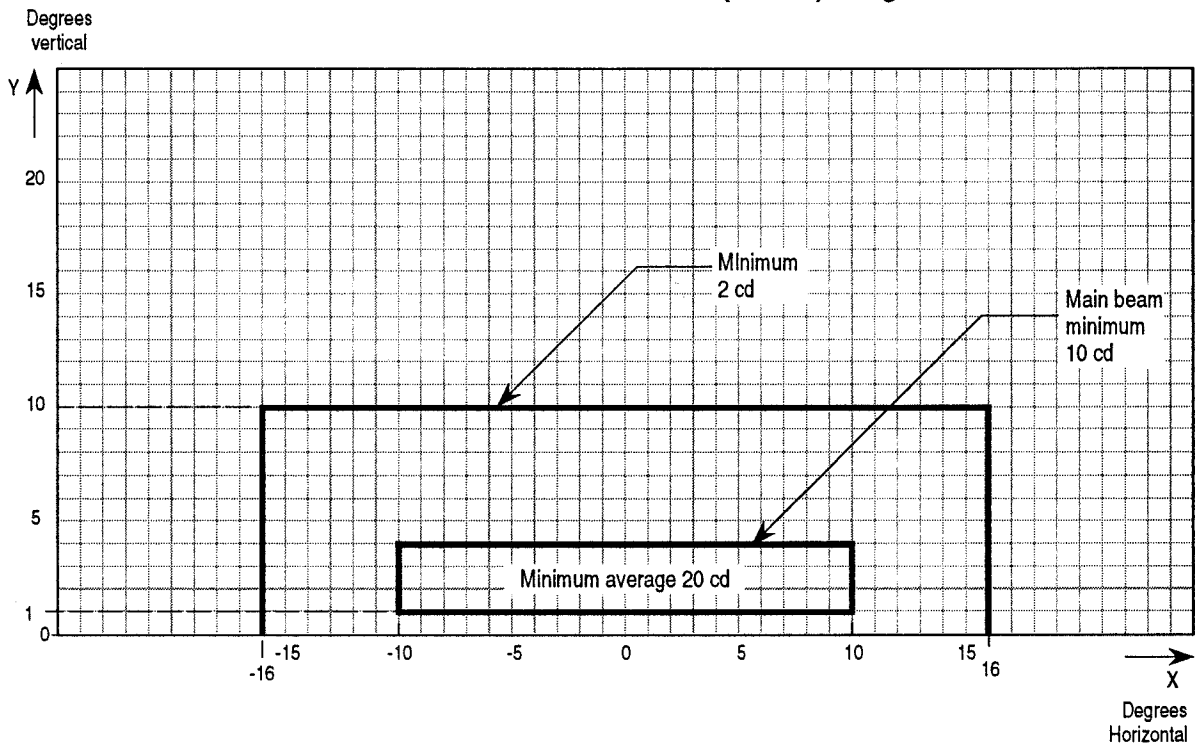

B.2.5 TAXIWAY CENTRE LINE LIGHTS (30 m, 60 m spacing) and STOP BAR LIGHTS IN CURVED SECTIONS INTENDED FOR USE IN RVR CONDITIONS OF 1400 FT OR GREATER

B.2.5.1 Standard.— The average intensity of the main beam of a taxiway centre line light spaced at longitudinal intervals of 30 m or 60 m or a stop bar light intended for use on curved sections in runway visual range conditions in the order of 1400 ft (400 m) or greater, shall be as illustrated in Figure B-17.

Note.— The beam coverages depicted in Figure B-17 allow for a displacement of the cockpit from the centre line of approximately 12 m as would occur on curves.

B.2.5.2 Standard.— Where the light units are installed on curved sections, they shall be toed-in 15.75 degrees with respect to the tangent of the curve.

B.2.5.3 Recommendation.— At locations where high background luminance is usual and where deterioration of light output resulting from dust, snow, and local contamination is a significant factor, the intensity values shown in Figure B-17 should be multiplied by 2.5.

B.2.5.4 Standard.— The measurement of intensity and alignment shall be in accordance with B.2.7.

Figure B-17. Isocandela diagram for taxiway centre line (30 m and 60 m spacing) and stop bar lights in curved sections intended for use in runway visual range conditions of the order of 1400 ft (400 m) or greater

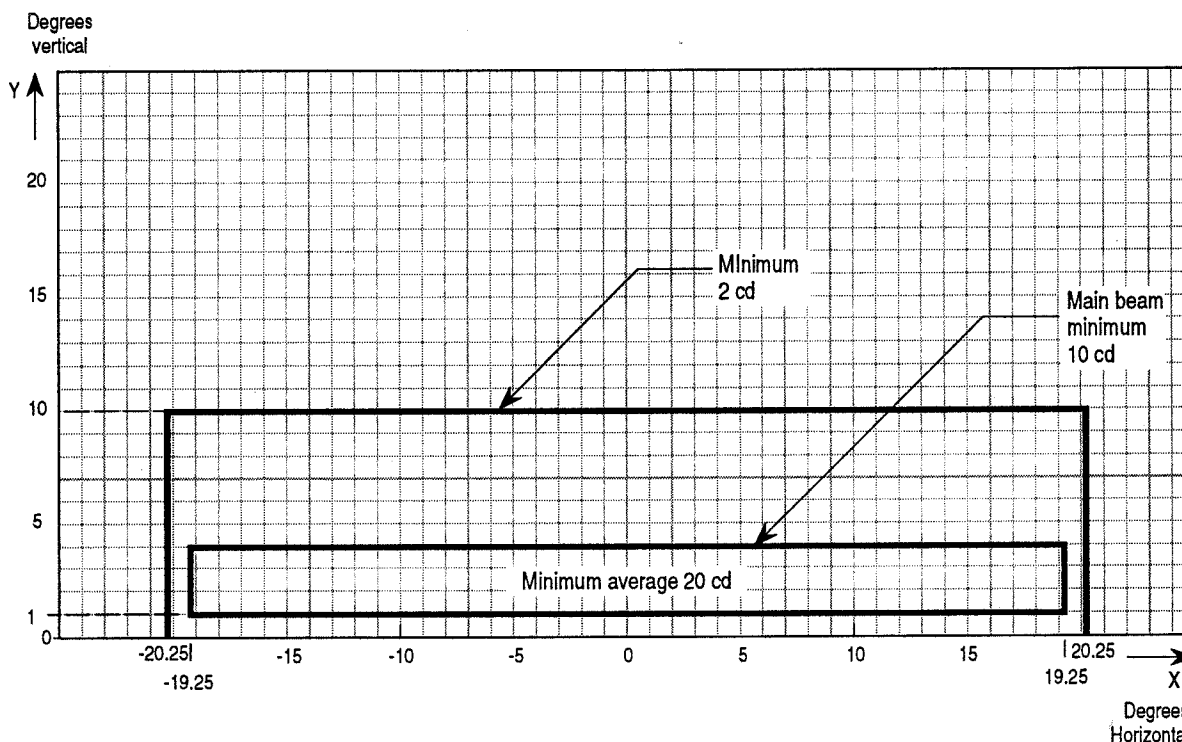

B.2.6 RUNWAY GUARD LIGHTS (configuration A)

B.2.6.1 Standard.— The average intensity of the main beam of a runway guard light, configuration A shall be as illustrated in Figure B-18.

Figure B-18. Isocandela diagram for runway guard lights, configuration A

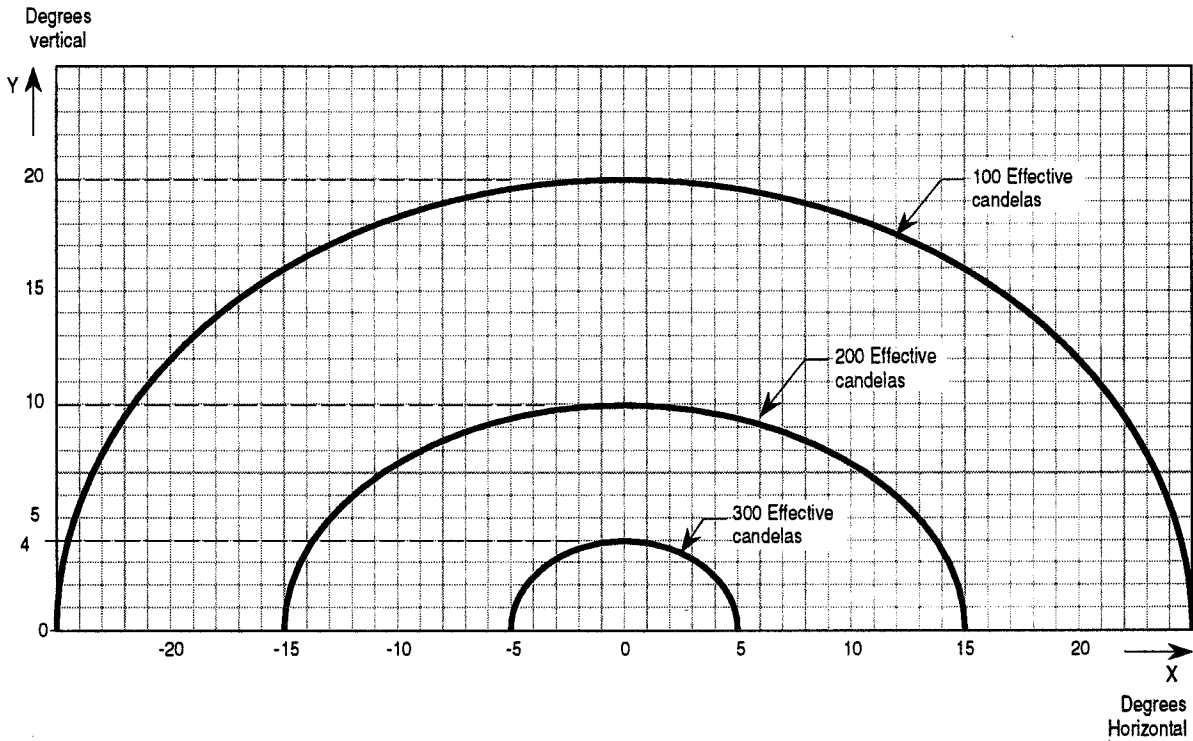

B.2.7 COLLECTIVE REQUIREMENTS FOR TAXIWAY LIGHTS

B.2.7.1 Standard.— The average intensity of the main beam of a taxiway light (sections B.2.1 to B.2.6) shall be calculated by establishing grid points as shown in Figure B-19 and using the intensity values measured at all grid points located within and on the perimeter of the rectangle representing the main beam. The average value shall be the arithmetic average of light intensities measured at all considered grid points.

B.2.7.2 Standard.— Horizontal angles shall be measured with respect to the vertical plane through the taxiway centre line except on curves where they are measured with respect to the tangent of the curve. Vertical angles shall be measured from the longitudinal slope of the taxiway surface.

B.2.7.3 Standard.— Taxiway light units shall be installed so that the main beam is aligned within one-half degree of the specified requirement.

B.2.7.4 Standard.— Deviations in the main beam pattern shall not be acceptable when the lighting fixture is properly aimed.

Figure B-19. Grid points to be used for the calculation of average intensity of taxiway centre line and stop bar lights

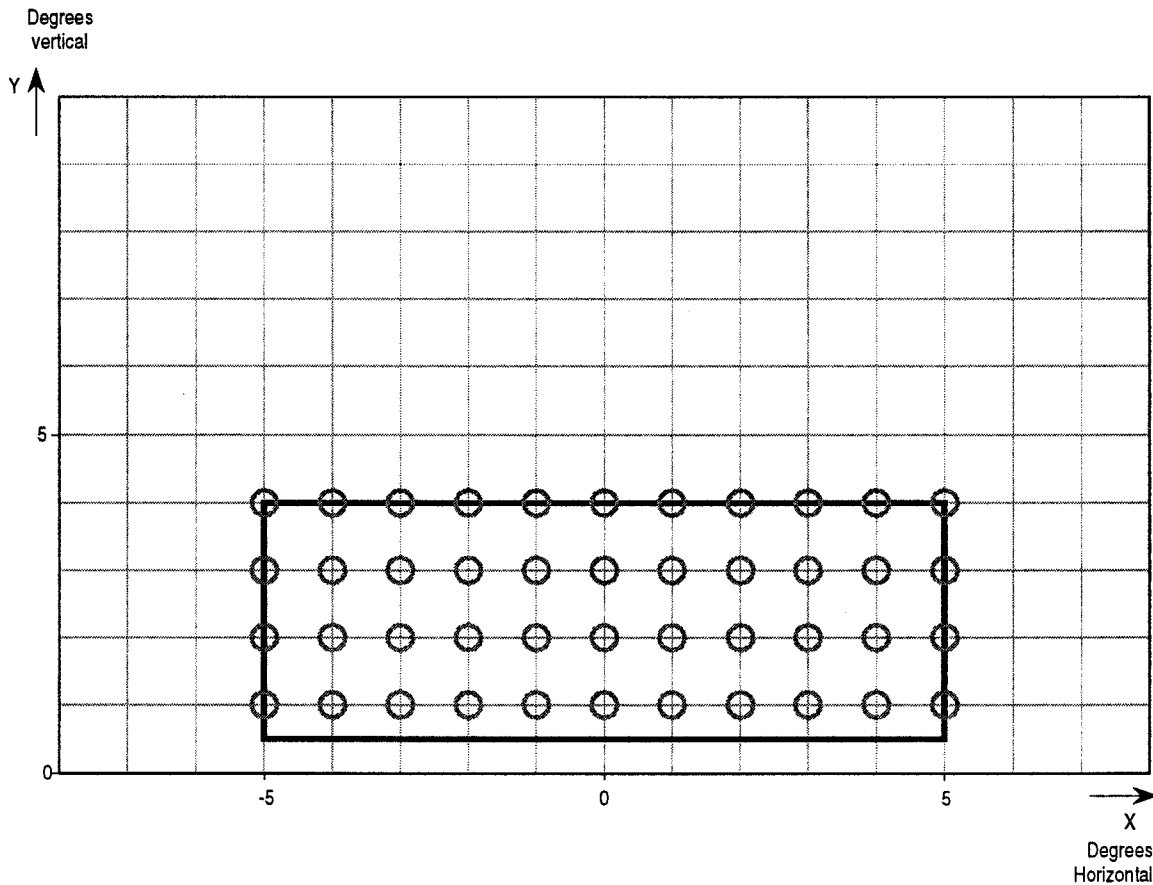

B.3 VISUAL APPROACH SLOPE INDICATOR SYSTEMS

B.3.1 PAPI and APAPI

B.3.1.1 Standard.— The light intensity distribution of a PAPI or APAPI light unit shall be as illustrated in Figure B-20.

Note.— The curves shown in Figure B-20 are for minimum intensities in red light.

B.3.1.2 Standard.— The light intensity value of the white sector of the beam as illustrated in Figure B-20 shall not be less than 2 times the corresponding intensity in the red sector.

Note.— The intensity value in the white sector of the beam may be as high as 6.5 times the corresponding intensity in the red sector.

B.3.1.3 Standard.— At full intensity, the red light shall have a Y coordinate not exceeding 0.320.

Figure B-20. Light intensity and distribution of PAPI and APAPI

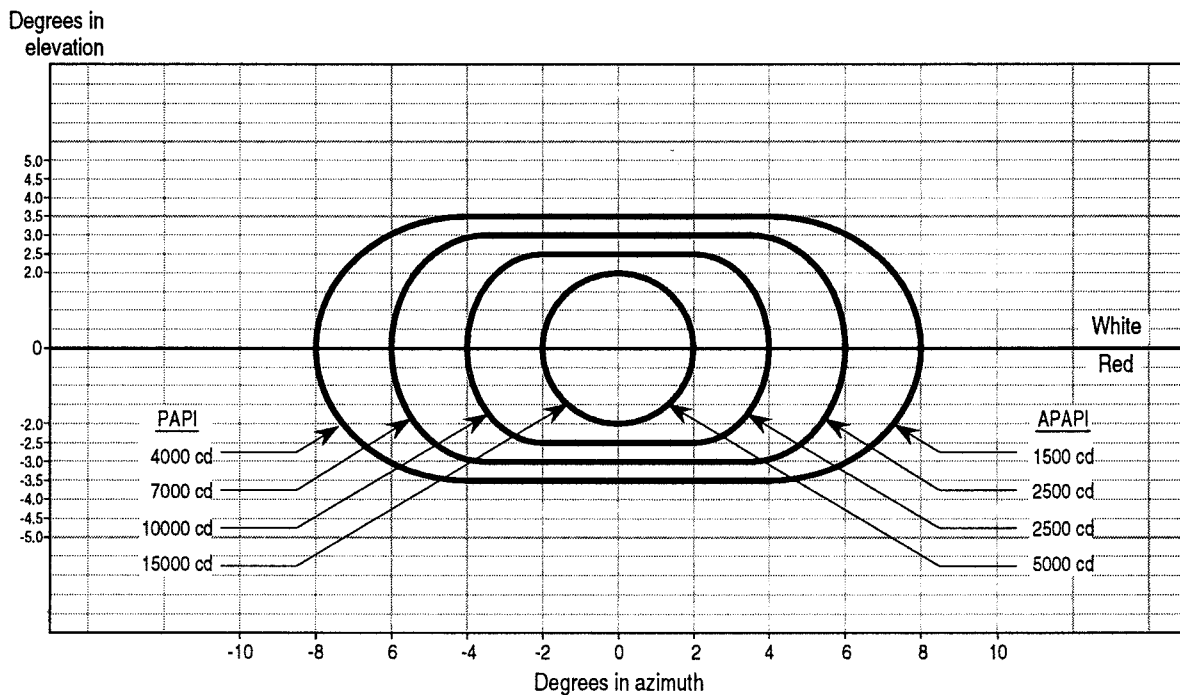

APPENDIX C. AIRSIDE GUIDANCE SIGN DESIGN SPECIFICATIONS

Introductory Note.— These specifications detail the design requirements of mandatory instruction and information signs (collectively known as airside guidance signs) to be located on the movement area of an aerodrome. The type of signs, inscriptions, and information to be conveyed, are determined in accordance with Section 5.4. The pictorial representation of those requirements are the subject of this appendix.

Note.— The minimum inscription height for a particular sign application is specified in 5.4.1.5.

C.1.1.2 Standard.— The sign face size and proportion shall be in relationship to inscription size and shall be in accordance with Figure C-1.

Borders

C.1.1.3 Standard.— Where a location sign is not used to form part of an array, it shall have a yellow border surrounding the sign. The width of the border shall be approximately 0.5 of the width of the stroke used to make the location sign inscription.

C.1.1.4 Standard.— Where information signs have been combined together to form an array, the individual signs shall be delineated by a vertical black stripe between sign inscriptions. The width of the delineator shall be 0.7 of the width of the stroke used to make the sign inscription.

C.1 GENERAL REQUIREMENTS

C.1.1 SIGN FACE AND INSCRIPTION DIMENSIONS

Face size

C.1.1.1 Standard.— The face height of signs shall be as follows:

Inscription height	Face height	
	Min	Desired
200 mm	300 mm	400 mm
300 mm	450 mm	600 mm
400 mm	600 mm	800 mm

C.1.2 SIGN CHARACTER SIZE AND SPACING

C.1.2.1 Standard.— The size, form, and proportion of sign characters used to form the inscriptions on signs shall be in accordance with Table C-1 and Figure C-2.

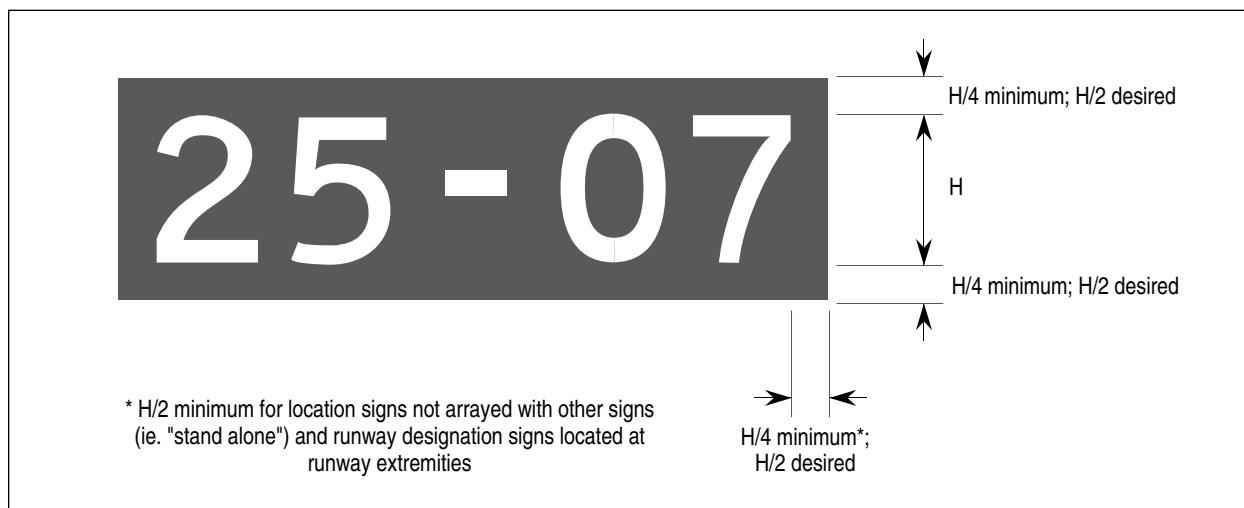

Figure C-1. Sign dimensions

Table C-1. Dimensions of sign characters

SIGN CHARACTER	WIDTH OF CHARACTER (millimetres)				
	Character Height (millimetres)				
	200	225	250	300	400
(1)	(2)	(3)	(4)	(5)	(6)
A	170	191	212	255	340
B	137	154	171	205	274
C	137	154	171	205	274
D	137	154	171	205	274
E	124	140	155	186	248
F	124	140	155	186	248
G	137	154	171	205	274
H	137	154	171	205	274
I	32	36	40	48	64
J	127	143	159	190	254
K	140	158	175	210	280
L	124	140	155	186	248
M	157	176	196	236	314
N	137	154	171	205	274
O	143	161	179	214	286
P	137	154	171	205	274
Q	143	161	179	214	286
R	137	154	171	205	274
S	137	154	171	205	274
T	124	140	155	186	248
U	137	154	171	205	274
V	152	171	190	229	304
W	178	200	222	267	356
X	137	154	171	205	274
Y	171	192	214	257	342
Z	137	154	171	205	274
1	50	56	61	74	98
2	137	154	171	205	274
3	137	154	171	205	274
4	149	168	186	224	298
5	137	154	171	205	274
6	137	154	171	205	274
7	137	154	171	205	274
8	137	154	171	205	274
9	137	154	171	205	274
0	143	161	179	214	286
DASH (-)	84	94	105	125	168
Stroke width (mm)	32	36	40	48	64

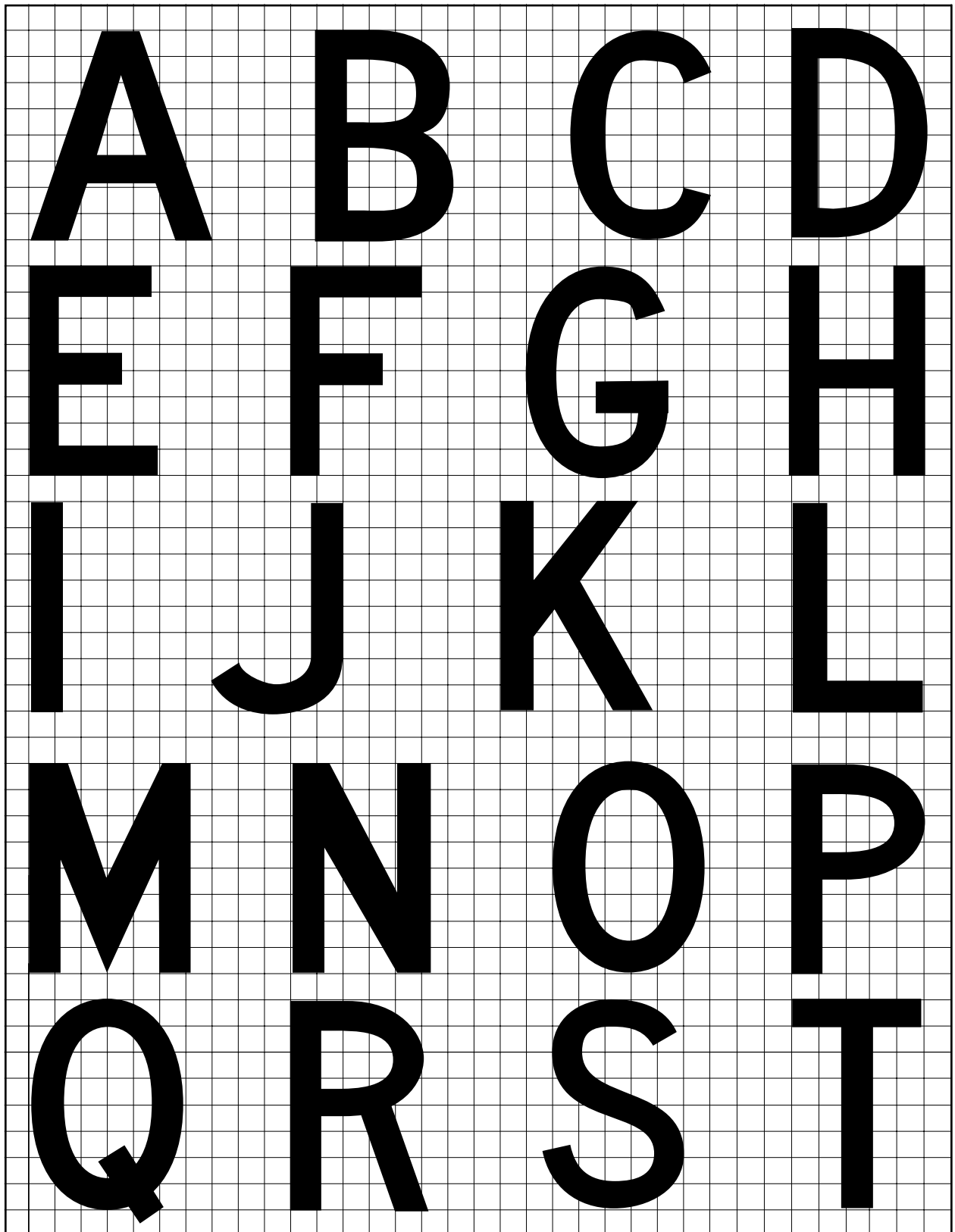

Figure C-2. Form and proportion of sign characters (sheet1)

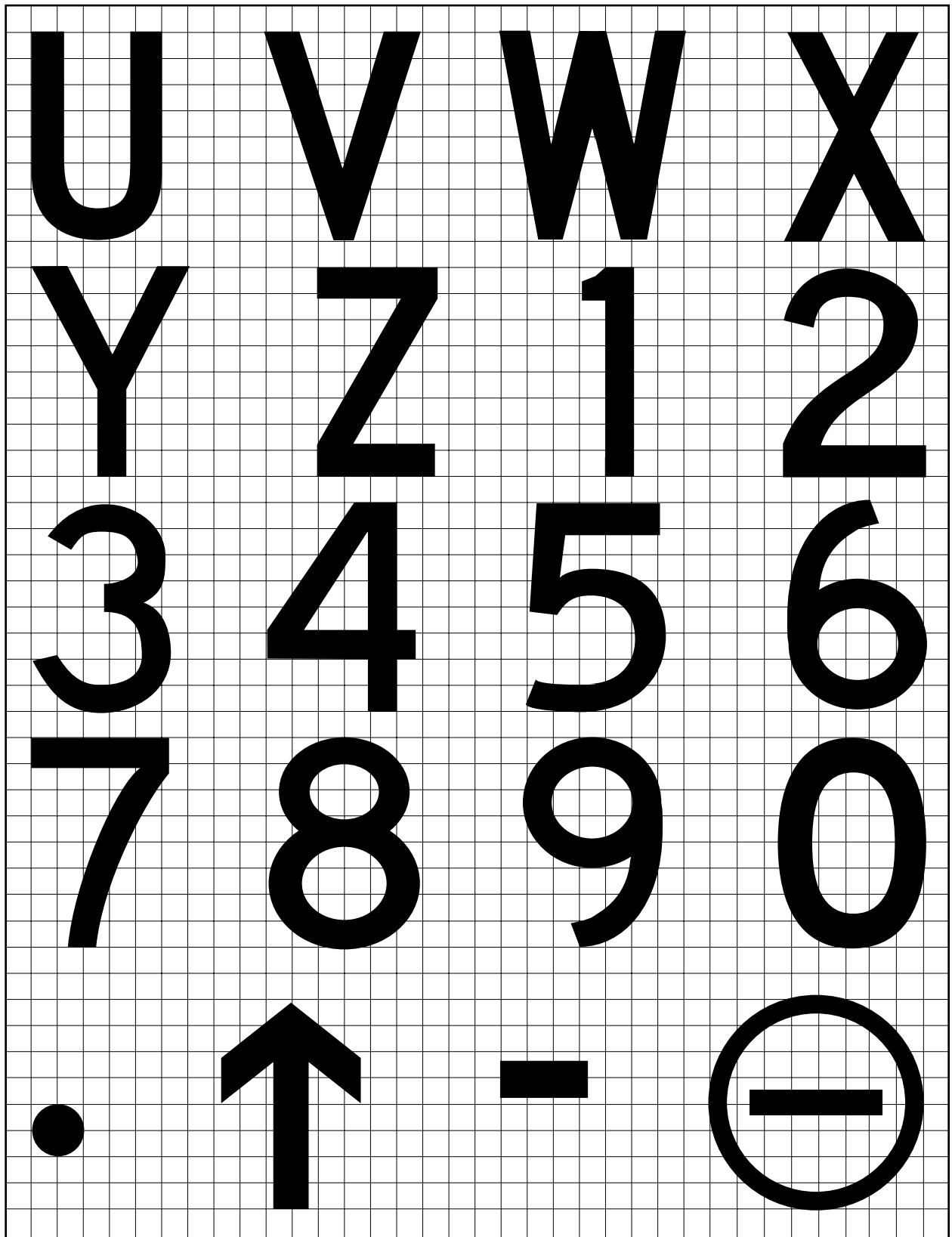

Figure C-2. Form and proportion of sign characters (sheet 2)

Table C-2. Sign character and word spacing

PRECEDING LETTER or NUMERAL	REFERENCE NUMBER for LETTER/NUMERAL to LETTER/NUMERAL SPACING				
	Following letter or Numeral				
	B, D, E, F, H, I, K, L, M, N, P, R, U, 1, 5	C, G, O, Q, S, X, Z, 2, ,3, 6, 8, 9, 0	A, J, T, V, W, Y, 4, 7		
(1)	(2)	(3)	(4)		
A	2	2	4		
B	1	2	2		
C	2	2	3		
D	1	2	2		
E	2	2	3		
F	2	3	3		
G	1	2	2		
H	1	1	2		
I	1	1	2		
J	1	1	2		
K	2	2	3		
L	2	2	4		
M	1	1	2		
N	1	1	2		
O	1	2	2		
P	1	2	2		
Q	1	2	2		
R	1	2	2		
S	1	2	2		
T	2	2	4		
U	1	1	2		
V	2	2	4		
W	2	2	3		
X	2	2	3		
Y	2	2	4		
Z	2	2	3		
1	1	1	2		
2	1	2	2		
3	1	2	2		
4	2	2	4		
5	1	2	2		
6	1	2	2		
7	2	2	4		
8	1	2	2		
9	1	2	2		
0	1	2	2		
SPACE (in millimetres) MEASURED HORIZONTALLY FROM THE EXTREME RIGHT EDGE OF THE PRECEDING LETTER OR NUMERAL TO THE EXTREME LEFT EDGE OF THE FOLLOWING LETTER OR NUMERAL					
Reference number (from above)	Letter/Numeral Height (mm)				
	200	225	250	300	400
1	48	54	59	71	96
2	38	43	48	57	76
3	25	28	32	38	50
4	13	14	16	19	26
Word space	38	43	48	57	76

C.1.2.2 Standard.— Where characters are strung together to form a message element within an inscription, the spacing between characters and words shall be in accordance with Table C-2.

C.1.2.3 Standard.— Signs made in multiple sections shall appear to the viewer as displaying a single message element.

C.1.3 SIGN CONSTRUCTION

General

C.1.3.1 Standard.— Signs shall be constructed of light weight non-ferrous materials.

C.1.3.2 Standard.— Signs, including all required components, shall be designed for continuous outdoor use under the following environmental conditions:

- a) Temperature: An ambient temperature range from minus 55 degrees Celsius to plus 55 degrees Celsius;
- b) Wind: Exposure to wind velocities of 320 km/hr (200 mph);
- c) Rain: Exposure to driving rains;
- d) Snow and Ice: Exposure to snow and icing conditions;
- e) Salt: Exposure to salt laden atmospheres; and
- f) Humidity: Exposure to relative humidity from 5 to 95 percent.

C.1.3.3 Standard.— Signs with spring mounting shall be sturdy so as to not cause vibration leading to decreased lamp life. The sign shall be sufficiently rigid to withstand a wind loading of 95 km/hr without deflection. At wind speeds greater than 95 km/hr, the sign shall deflect not more than 35 degrees. Upon release of wind loading which causes deflection, the sign shall immediately return to its normal vertical position without excessive vibration or overswing.

Frangibility and withstand

C.1.3.4 Standard.— The mounting legs for each sign shall be frangible so as to break, distort or yield upon impact so as to present the

minimum hazard of the sign to aircraft.

C.1.3.5 Standard.— Where the frangible means is of breakable couplings, these couplings shall be provided at the base of the mounting leg and shall be such that the break point is located at least 50mm above the concrete pad or anchor stake.

C.1.3.6 Standard.— Signs, that are intended to deform or yield upon impact, shall do so in a manner to cause the sign to fall to ground level and to be passed over by the aircraft.

C.1.3.7 Standard.— Signs shall be constructed with mounting strength such that the sign is capable of withstanding environmental conditions of wind gusts and jet blast. In addition, the face panel and panel supports (ie. frame) shall withstand, as a minimum, the pressure at which the frangible points break.

Note.— *The withstand and frangibility strengths are specified in terms of wind loading (pressure) using the following formula:*

$$P=K*V^2$$

where: P = pressure in kPa (lb/ft²)
 V = wind speed in km/hr (mph)
 K = 0.00005 (0.0027)

C.1.3.8 Standard.— Signs shall withstand a wind loading of 320 km/hr (200 mph) and shall break before the wind loading reaches 480 km/hr (300 mph).

C.1.3.9 Standard.— The frangibility and withstand capability of the sign shall be proven for the clearance height of 1200mm. The frangible device used for this clearance may be also used for installations of lesser clearance height.

Noninterference with navigation aids

C.1.3.10 Standard.— Signs may be constructed with metallic face and back panels. This style of design, however, shall not be such as to cause interference with surface radar or electronic navigation aids.

C.2 RETROREFLECTIVE SIGNS

C.2.1 GENERAL

C.2.1.1 Standard.— Retroreflective material for application on illuminated signs shall meet the colour and reflectivity of ASTM D4956, Type 1 sheeting.

C.2.1.2 Standard.— Retroreflective material for non-illuminated signs shall meet the colour and reflectivity of ASTM D4956, Type 3 or 4 sheeting.

C.3 ILLUMINATED SIGNS

C.3.1 GENERAL

C.3.1.1 Standard.— Signs made in multiple sections shall appear to the viewer as displaying a single message element and illuminated area. The transition between sections shall not present a noticeable darkened area to the pilot. The letters/numerals of the legend may be applied across this point of transition.

C.3.2 INTERNALLY ILLUMINATED SIGNS

General

C.3.2.1 Recommendation.— The sign frame should be provided with a small window that permits daytime inspection for failed lamps.

Note.— Normally, the inspection window should be located at the end of sign frame. In the case of sign modules that form a sign array, this location may not be practical and other location may be used.

C.3.2.2 Recommendation.— The window should have a clear plastic cover which is sealed against environmental conditions.

Sign luminance

C.3.2.3 Standard.— Sign luminance (average sign luminance) shall be as follows:

Red	10 - 30	cd/m ²
Yellow	50 - 150	cd/m ²
White	100 - 300	cd/m ²

C.3.2.4 Recommendation.— At locations where high background luminance is usual, the luminance values shown in C.3.2.3 should be increased by a factor between 2 and 3.

C.3.2.5 Standard.— With all lamps operating, the luminance ratio between red and white elements of a mandatory instruction sign shall not be greater than 1:10.

C.3.2.6 Standard.— The average luminance of the sign shall be calculated by establishing grid points as shown in Figure C-3 and using the luminance values measured at all grid points located within the rectangle representing the sign.

C.3.2.7 Standard.— The average value shall be the arithmetic average of the luminance values measured at all considered grid points.

C.3.2.8 Standard.— The background and border on location signs shall have an average luminance of 30 to 100 cd/m² (10 to 30 foot-lamberts). With all lamps operating, the uniformity shall be 10:1 over the sign face and 1.5:1 between adjacent grid points as indicated in Figure C-3

C.3.2.9 Standard.— Lamp failure shall not cause a reduction of luminance of more than 50 percent in the area of the sign face applicable to the failed lamp.

Note.— With lamp failure, the uniformity requirement specified in C.3.2.5 and C.3.2.8 may be exceeded.

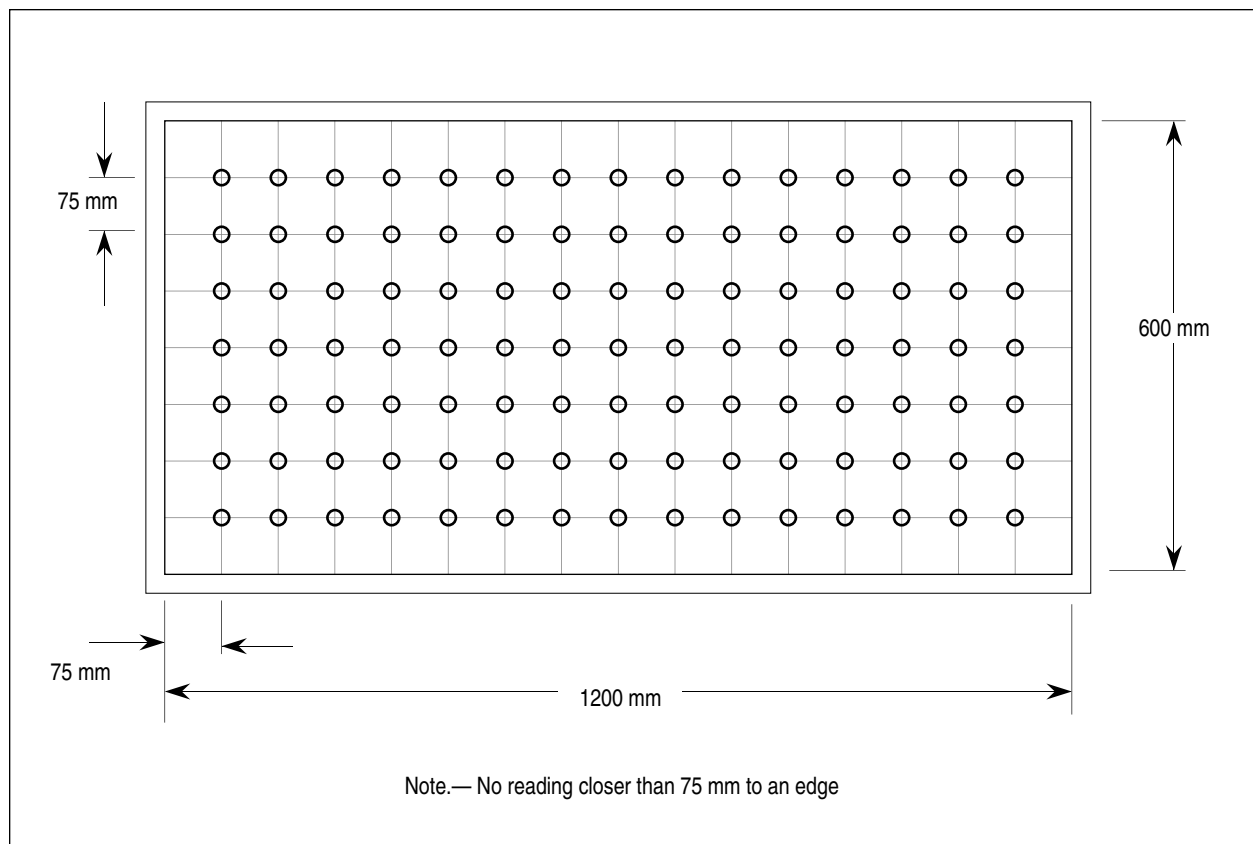

Figure C-3. Grid points for luminance measurement of internally illuminated signs

C.3.3 FIBREOPTIC SIGNS

General

C.3.3.1 Standard.— The sign shall be provided with an additional fibreoptic point for each of the enclosed lamps. These fibreoptic points shall be located on the side of the sign so that maintenance personnel can verify the operation of the associated lamps.

C.3.3.2 Standard.— The fibreoptic points that illuminate a character shall have a spacing of not more than 20mm.

C.3.3.3 Standard.— The loci (line of) fibreoptic points shall follow the centre of the character, except that it shall be shifted to the left edge of the vertical member of letters "B", "D", "E", "F", "K", "L", "P", and "R", and the numeral "5". In addition, the loci shall follow the lower edge of the cross member of letters "A", "E", "F", and "H".

Photometric Performance

C.3.3.4 Standard.— The fibreoptic sign shall have the photometric distribution, as shown in Figure C-4.

C.3.3.5 Standard.— For the purpose of photometric testing, the white colour shall be used and the intensity and distribution shall be in accordance with Figure C-4.

C.3.3.6 Standard.— Lamp failure shall not cause a reduction of intensity of more than 50 percent for the fibreoptic points applicable to a message element to which these lamps apply. The reduction shall not occur in a manner as to reduce the number of illuminated points within a loci of points.

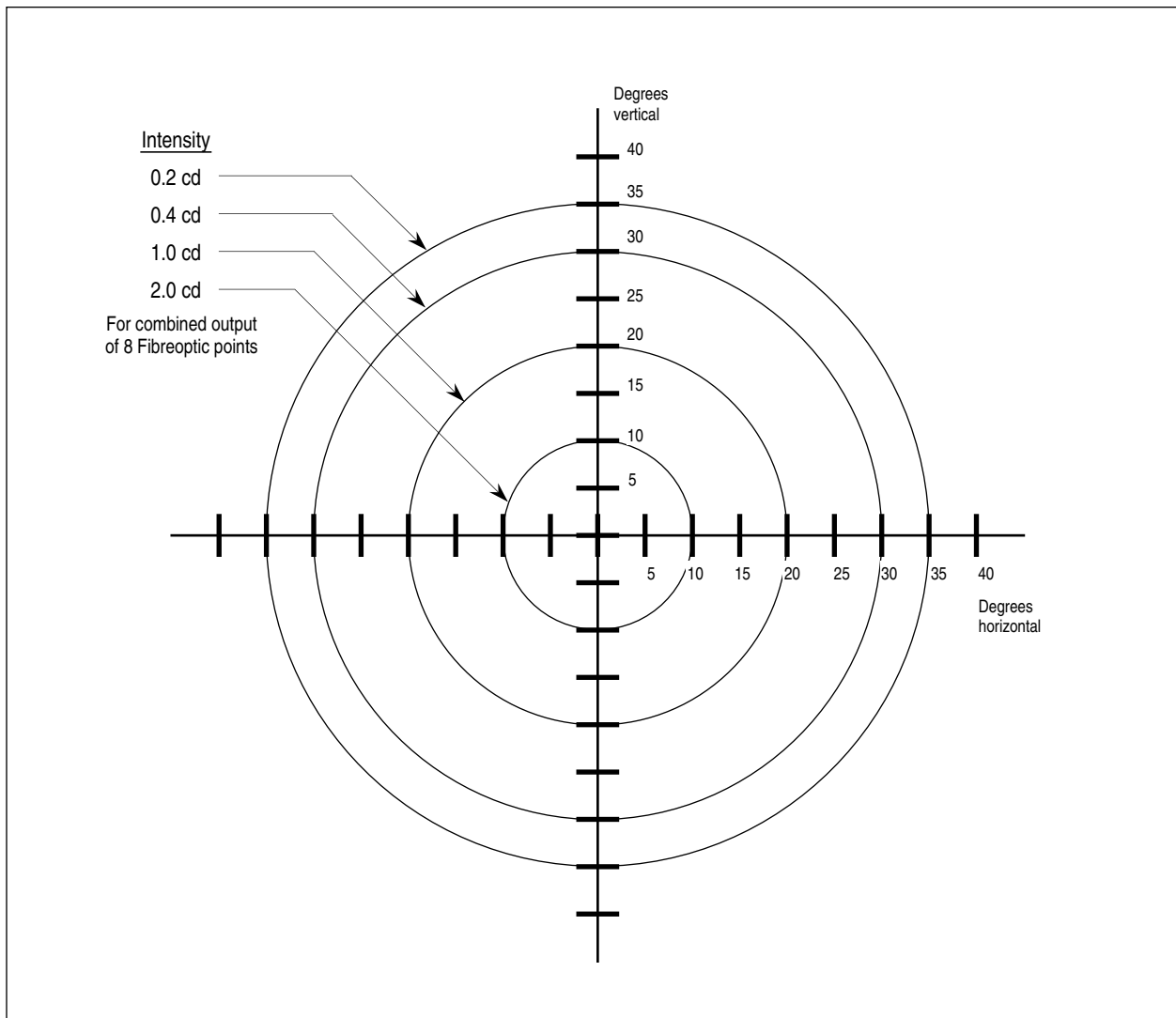

Figure C-4. Photometric distribution for fibreoptic signs

ATTACHMENTS

ATTACHMENT A

GUIDANCE MATERIAL SUPPLEMENTARY TO TP 312E, AERODROME STANDARDS AND RECOMMENDED PRACTICES

	<i>Page</i>
1. NUMBER, ORIENTATION and SITING of RUNWAYS	1
2. CLEARWAYS and STOPWAYS	2
3. SLOPES ON A RUNWAY	3
4. RUNWAY SURFACE EVENNESS	4
5. STRIPS	4
6. RUNWAY END SAFETY AREAS	7
7. TAXIWAY EDGE LIGHTS - "SEA OF BLUE " EFFECT	7
8. AIR SIDE PROTECTIVE MEASURES	8
9. QUALITY ASSURANCE TESTS FOR AIRSIDE GUIDANCE SIGNS	11

ATTACHMENT A. GUIDANCE MATERIAL SUPPLEMENTARY TO TP 312E, AERODROME STANDARDS AND RECOMMENDED PRACTICES

1. NUMBER, SITING AND ORIENTATION OF RUNWAYS

Siting and orientation of runways

1.1 Many factors should be taken into account in the determination of the siting and orientation of runways. Without attempting to provide an exhaustive list of these factors nor an analysis of their effects, it appears useful to indicate those which most frequently require study. These factors may be classified under four headings:

1.1.1 Type of operation. Attention should be paid in particular to whether the aerodrome is to be used in all meteorological conditions or only in visual meteorological conditions, and whether it is intended for use by day and night, or only by day.

1.1.2 Climatological conditions. A study of the wind distribution should be made to determine the usability factor. In this regard, the following comments should be taken into account:

- a) Wind statistics used for the calculation of the usability factor are normally available in ranges of speed and direction, and the accuracy of the results obtained depends, to a large extent, on the assumed distribution of observations within these ranges. In the absence of any sure information as to the true distribution, it is usual to assume a uniform distribution since, in relation to the most favourable runway orientations, this generally results in a slightly conservative figure for the usability factor.
- b) The maximum mean cross-wind components given in Chapter 3, 3.1.2 refer to normal circumstances. There are some factors which may require that a reduction of those maximum values be taken into account at a particular aerodrome. These include:

- 1) the wide variations which may exist, in handling characteristics and maximum permissible cross-wind components, among diverse types of aeroplanes (including future types) within each of the three groups given 3.1.1.2;
- 2) prevalence and nature of gusts;
- 3) prevalence and nature of turbulence;
- 4) the availability of a secondary runway;
- 5) the width of runways;
- 6) the runway surface conditions - water, snow and ice on the runway materially reduce the allowable cross-wind component; and
- 7) the strength of the wind associated with the limiting cross-wind component.

A study should also be made of the occurrence of poor visibility and/or low cloud base. Account should be taken of their frequency as well as the accompanying wind direction and speed.

1.1.3 Topography of the aerodrome site, its approaches, and surroundings, particularly:

- a) compliance with the obstacle limitation surfaces;
- b) current and future land use. The orientation and layout should be selected so as to protect as far as possible the particularly sensitive areas such as residential, school and hospital zones from the discomfort caused by aircraft noise;
- c) current and future runway lengths to be provided;
- d) construction costs; and

- e) possibility of installing suitable non-visual and visual aids for approach-to-land.

1.1.4 Air traffic in the vicinity of the aerodrome, particularly:

- a) proximity of other aerodromes or ATS routes;
- b) traffic density; and
- c) air traffic control and missed approach procedures.

Number of runways in each direction

1.2 The number of runways to be provided in each direction depends on the number of aircraft movements to be catered to.

2. CLEARWAYS AND STOPWAYS

2.1 The decision to provide a stopway and/or a clearway as an alternative to an increased length of runway will depend on the physical characteristics of the area beyond the runway end, and on the operating performance requirements of the prospective aeroplanes. The runway, stopway and clearway lengths to be provided are determined by the aeroplane take-off performance, but a check should also be made of the landing distance required by the aeroplanes using the runway to ensure that adequate runway length is provided for landing. The length of a clearway, however, cannot exceed half the length of take-off run available.

2.2 The aeroplane performance operating limitations require a length which is enough to ensure that the aeroplane can, after starting a take-off, either be brought safely to a stop or complete the take-off safely. For the purpose of discussion it is supposed that the runway, stopway and clearway lengths provided at the aerodrome are only just adequate for the aeroplane requiring the longest take-off and accelerate-stop distances, taking into account its take-off mass, runway characteristics and ambient atmospheric conditions. Under these circumstances there is, for each take-off, a speed, called the decision speed; below this speed, the take-off must be abandoned if an engine fails, while above it the take-off must be completed. A very long take-off

run and take-off distance would be required to complete a take-off when an engine fails before the decision speed is reached, because of the insufficient speed and the reduced power available. There would be no difficulty in stopping in the remaining accelerate-stop distance available provided action is taken immediately. In these circumstances the correct course of action would be to abandon the take-off.

On the other hand, if an engine fails after the decision speed is reached, the aeroplane will have sufficient speed and power available to complete the take-off safely in the remaining take-off distance available. However, because of the high speed, there would be difficulty in stopping the aeroplane in the remaining accelerate-stop distance available.

2.3 The decision speed is not a fixed speed for any aeroplane, but can be selected by the pilot within limits to suit the accelerate-stop and take-off distance available, aeroplane take-off mass, runway characteristics, and ambient atmospheric conditions at the aerodrome. Normally, a higher decision speed is selected as the accelerate-stop distance available increases.

2.4 A variety of combinations of accelerate-stop distances required and take-off distances required can be obtained to accommodate a particular aeroplane, taking into account the aeroplane take-off mass, runway characteristics, and ambient atmospheric conditions. Each combination requires its particular length of take-off run.

2.5 The most familiar case is where the decision speed is such that the take-off distance required is equal to the accelerate-stop distance required; this value is known as the balanced field length. Where stopway and clearway are not provided, these distances are both equal to the runway length. However if landing distance is for the moment ignored, runway is not essential for the whole of the balanced field length, as the take-off run required is, of course, less than the balanced field length. The balanced field length can, therefore, be provided by a runway supplemented by an equal length of clearway and stopway, instead of wholly as a runway. If the runway is used for take-off in both directions, an equal length of clearway and stopway has to be provided at each runway end. The saving in

runway length is, therefore, bought at the cost of a greater over-all length.

2.6 In case economic considerations preclude the provision of stopway and, as a result, only runway and clearway are to be provided, the runway length (neglecting landing requirements) should be equal to the accelerate-stop distance required or the take-off run required, whichever is the greater. The take-off distance available will be the length of the runway plus the length of clearway.

2.7 The minimum runway length and the maximum stopway or clearway length to be provided may be determined as follows, from the data in the aeroplane flight manual for the aeroplane considered to be critical from the viewpoint of runway length requirements:

- a) if a stopway is economically possible, the lengths to be provided are those for the balanced field length. The runway length is the take-off run required or the landing distance required, whichever is the greater. If the accelerate-stop distance required is greater than the runway length so determined, the excess may be provided as stopway, usually at each end of the runway. In addition, a clearway of the same length as the stopway must also be provided;
- b) if a stopway is not to be provided, the runway length is the landing distance required, or if it is greater, the accelerate-stop distance required, which corresponds to the lowest practical value of the decision speed. The excess of the take-off distance required over the runway length may be provided as clearway, usually at each end of the runway.

2.8 In addition to the above consideration, the concept of clearways in certain circumstances can be applied to a situation where the take-off distance required for all engines operating exceeds that required for the engine failure case.

2.9 The economy of a stopway can be entirely lost if, after each usage, it must be regraded and compacted. Therefore, it should be designed to withstand at least a certain number of loadings of the aeroplane which the stopway is intended to

serve without inducing structural damage to the aeroplane.

3. SLOPES ON A RUNWAY

3.1 Distance between slope changes

The following example illustrates how the distance between slope changes is to be determined (see Figure 1):

Distance D for a runway where the code number is 3 should be at least:

$$15000 (|x - y| + |y - z|) \text{ m}$$

where: $|x - y|$ is the absolute numerical value of $x - y$
 $|y - z|$ is the absolute numerical value of $y - z$

Example: Assuming; $x = +0.01$
 $y = -0.005$
 $z = +0.005$
then; $|x - y| = 0.015$
 $|y - z| = 0.01$

To comply with the specifications, D should be not less than:

$$15\ 000 (0.015 + 0.01) \text{ m}$$

$$\text{that is: } 15\ 000 \times 0.025 = 375 \text{ m}$$

$$D = 375 \text{ m}$$

3.2 Consideration of longitudinal and transverse slopes

When a runway is planned that will combine the extreme values for the slopes and changes in slope permitted under Chapter 3, 3.1.2.1 to 3.1.2.8, a study should be made to ensure that the resulting surface profile will not hamper the operation of aeroplanes.

3.3 Slope changes before runways

In order to accommodate aeroplanes making auto-coupled approaches and automatic landings (irrespective of weather conditions), it is desirable that slope changes be avoided, or kept to a minimum, on an area symmetrical about the extended runway centre-line approximately 60 m

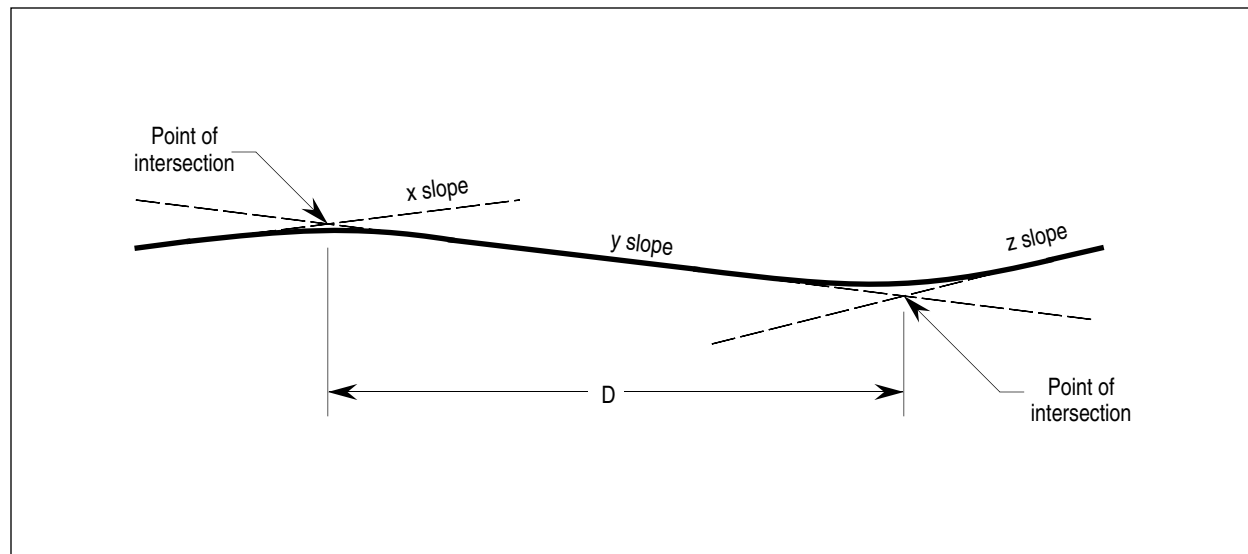

Figure 1. Slope changes on a runway - profile on centre line of runway

wide and 300 m long before the threshold of a precision approach runway. This is desirable because these aeroplanes are equipped with a radio altimeter for final height and flare guidance, and when the aeroplane is above the terrain immediately prior to the threshold, the radio altimeter will begin to provide information to the automatic pilot for auto-flare. Where slope changes cannot be avoided, the rate of change between two consecutive slopes should not exceed 2 per cent per 30 m.

4. RUNWAY SURFACE EVENNESS

4.1 In adopting tolerances for runway surface irregularities, the following standard of construction is achievable for short distances of 3 m and conforms to good engineering practice:

Except across the crown of a camber or across drainage - channels, the finished surface of the wearing course is to be of such regularity that, when tested with a 3 m straightedge placed anywhere in any direction on the surface, there is no deviation greater than 3 mm between the bottom of the straight-edge and the surface of the pavement anywhere - along the straight edge.

4.2 Caution should also be exercised when inserting runway lights or drainage grilles in runway

surfaces to ensure that adequate smoothness of the surface is maintained.

5. STRIPS

5.1 Shoulders

5.1.1 The shoulder of a runway or stopway should be prepared or constructed so as to minimize any hazard to an aeroplane running off the runway or stopway. Some guidance is given in the following paragraphs on certain special problems which may arise, and on the further question of measure to avoid the ingestion of loose stones or other objects by turbine engines.

5.1.2 In some cases, the bearing strength of the natural ground in the strip may be sufficient, without special preparation, to meet the requirements for shoulders. Where special preparation is necessary, the method used will depend on local soil conditions and the mass of the aeroplanes the runway is intended to serve. Soil tests will help in determining the best method of improvement (e.g. drainage, stabilization, surfacing, light paving).

5.1.3 Attention should also be paid when designing shoulders to prevent the ingestion of stones or other objects by turbine engines. Similar considerations apply here to those which are discussed for the margins of taxiways in the *ICAO*

Aerodrome Design Manual, Part 2, both as to the special measures which may be necessary and as to the distance over which such special measures, if required, should be taken.

5.1.4 Where shoulders have been treated specially, either to provide the required bearing strength or to prevent the presence of stones or debris, difficulties may arise because of a lack of visual contrast between the runway surface and that of the adjacent strip. This difficulty can be overcome either by providing a good visual contrast in the surfacing of the runway or strip, or by providing a runway side stripe marking.

5.2 Objects on strips

Within the general area of the strip adjacent to the runway, measures should be taken to prevent an aeroplane's wheel, when sinking into the ground, from striking a hard vertical face. Special problems may arise for runway light fittings or other objects mounted in the strip or at the intersection with a taxiway or another runway. In the case of construction, such as runways or taxiways, where the surface must also be flush with the strip surface, a vertical face can be eliminated by chamfering from the top of the construction to not less than 30 cm below the strip surface level. Other objects, the functions of which do not require them to be at surface level, should be buried to a depth of not less than 30 cm.

5.3 Temporary hazards on runway strips

It is the responsibility of the aerodrome operator to ensure that the existence of all temporary obstructions or hazards within strips be made known as appropriate to pilots, either directly by Air Traffic Control or by NOTAM.

The following paragraphs give guidance on the operational implications and dealing with temporary hazards on runways strips.

5.3.1 Three zones alongside runways can be identified as follows:

ZONE I. – This zone lies within 23 m of the runway edge where the runway code number is 2, 3, or 4; and, 21 m of the runway edge where the runway code number is 1.

ZONE II. – This zone extends from the outer edge of Zone I to the edge of the graded strip. Refer to Chapter 3 for dimension of graded areas.

ZONE III. – This zone applies only to non-precision approach runways used in conditions of poor visibility or low cloud base. It extends outwards from the edge of the graded strip to the edge of the strip required for missed approaches, i.e. 150 m from the runway centre line.

5.3.2 Procedures for Zone 1. No work should be permitted on a precision approach runway when the runway is in use. For a non-instrument or non-precision approach runway, work may take place in this zone on only one side of the runway at a time. The area of the obstacle should not exceed 9 m², but narrow trenches may exceptionally be allowed up to 28 m². Any obstacle permitted should be limited in height to provide propeller or pod clearance for the type of aircraft using the aerodrome, and in no case should the height exceed 1 m above the ground. Any piles of earth or debris which could damage aircraft or engines must be removed. Trenches and other excavations should be backfilled and compacted as soon as possible.

No plant or vehicles should operate in this zone when the runway is in use.

An aircraft immobilized in this zone would automatically require the closure of the runway.

5.3.3 Procedures for Zone 2. No work should be permitted on a precision approach runway when the runway is in use. For a non-instrument or non-precision approach runway, the restrictions to be applied depend on the type of operation taking place and the weather conditions.

With a dry runway and not more than 15 Kt cross-wind component for runways of code number 4, and 10 Kt cross-wind component for runways of code number 2 or 3, the following work may be permitted:

- a) Visual flight conditions:
- i) Unrestricted areas of construction, with the length of excavation or excavated material parallel to the runway being kept to a minimum. The overall height of excavated material should be limited to 2 m above the ground.
 - ii) All construction equipment should be mobile and kept within normal height limits.
 - ii) The runway may continue in use when an aircraft is immobilized in this zone.
- b) Instrument flight conditions:
- i) Unrestricted areas of construction, with the length of excavation or excavated material parallel to the runway being kept to a minimum. The overall height of excavated material should be limited to 2 m above the ground.
 - ii) All construction equipment should be mobile and kept within normal height limits.
 - iii) When an aircraft becomes immobilized in this zone, the runway should be closed.

5.3.4 Procedures for Zone 3. There are no restrictions on the work in this area. However, care must be taken to ensure that the work and the vehicles associated with the work do not interfere with the operation of radio navigational aids.

Note.— Contractor's permanent and semi-permanent plant and mobile equipment withdrawn from the strips should not infringe the transitional surfaces described in chapter 4.

5.3.5 Runway Ends. In the case of work adjacent to the runway ends, the maximum possible use should be made of alternate runways or the displacement of the threshold so that the obstacle does not fall within the effective strip length or penetrate the associated approach surfaces. However, where landing distance may be critical, it may be safer to permit such an infringement near the runway end rather than displace the threshold.

5.3.6 Procedures during Navigation Aid Flight Inspection. Notwithstanding the foregoing

instruction contained in 5.3.2 and 5.3.3, a theodolite and radio equipped flight inspection technician may be permitted in either Zone I or Zone II during precision approach navigation aid flight inspection while a runway is in use. It is recommended that NOTAM and voice advisory be issued during flight inspections.

5.3.7 Pre-Construction Meeting. It is an excellent practice for the contractor, airport operator and traffic control authority (where traffic control exists) to meet well in advance of the start of construction. This meeting can then consider such matters as discussed above, and agree on:

- a) means of control of construction vehicles so as to minimize interference with aircraft operations;
- b) scheduling of construction activities to conform as much as possible to periods of minimum aircraft activity; and
- c) disposal of excavated material, storage of construction material and equipment, and conditions of work site at the end of the period of work.

5.3.8 Procedures for Revising Declared Distances. In the event that an unacceptable obstacle exists within the strip areas or associated clearway, the continued availability of the runway may be authorized at a restricted length, if the reduced distances available would be operationally usable by the type of traffic expected. The declared distances have a statutory application in aircraft operations and it is important that amendments are made when circumstances give a rise to their restrictions. See example in Figure 1, Appendix A.

The changes to the declared distances for a runway restricted in length by the presence of an obstacle are to be made as follows:

- a) Commencement of takeoff runs from the obstructed end. TORA may commence at the beginning of the usable runway.
- b) Termination of declared distances towards the obstructed end.

TORA - terminates at the end of the usable runway.

- ASDA - terminates at the end of the runway or stopway if provided.
- TODA - terminates at the obstruction or at TORA plus 300 m (1,000 ft.), whichever comes first.
- LDA - terminates at the end of the usable runway.

5.3.9 Instrument Approach Procedures.

The presence of temporary obstructions and/or changes to the runway threshold may require an amendment to the instrument approach procedure. Details should be provided to the Certifying Authority.

5.3.10 Taxiway Obstructions.

In considering the acceptability of an obstruction near a taxiway the aerodrome operator will be guided by the type of aircraft using the airport and the availability of an alternative ground routing avoiding the affected length of taxiway. A clearance distance of whichever is the greater of 20% of wing span or 7.5 m (25 ft.) should be preserved between the obstruction and the wing tip of an aircraft on the taxiway centre line, when the aircraft is permitted to use that taxiway. If in doubt a marshaller should be positioned at the point and the pilot warned by radio when approaching the affected area.

5.3.11 Marking of Obstructions.

The marking by day and night of obstructed areas should be in accordance with the marking requirements of unserviceable areas of a runway, taxiway or other areas prescribed in Chapter 7. It will be appropriate by night, and possible by day also, to mark the perimeter of the obstruction itself if it is close to a taxiway, the continued use of which has been authorized. However, it will serve little purpose to a pilot landing or taking off, to mark either by day or night, an obstruction in a position which does not affect the continued use of the runway. Indeed, extraneous red lights may be misleading from the air and the pilot is only interested in seeing a pattern which clearly indicates the part of the runway which can be used.

5.3.12 Tall Obstruction (e.g. Cranes, etc.). The responsibility for lighting and marking of obstructions rests with the aerodrome operator regardless of the owner of the obstruction. A

certificate may be withheld or withdrawn if the requirements for lighting and/or marking are not met. Every attempt should be made to remove or lower the obstruction during the hours of darkness or during periods of idleness, i.e. weekends, etc. If this is not practicable, the obstruction should be marked at the top by one or more obstruction (red) lights. Day marking normally will not be required where the obstruction is painted in bright colours.

6. RUNWAY END SAFETY AREAS

6.1 Where a runway end safety area is provided in accordance with Chapter 3, consideration should be given to providing an area long enough to contain overruns and under shoots resulting from a reasonably probable combination of adverse operational factors. On a precision approach runway the ILS localizer is normally the first upstanding obstacle, and the runway end safety area should extend up to this facility. In other circumstances and on a non-precision approach or non-instrument runway, the first upstanding obstacle may be a road, a railroad or other constructed or natural feature. In such circumstances, the runway end safety area should extend as far as the obstacle.

6.2 Where provision of a runway end safety area may involve encroachment in areas where it would be particularly prohibitive to implement, and the appropriate authority considers a runway end safety area essential, consideration may have to be given to reducing some of the declared distances.

7. TAXIWAY EDGE LIGHTS - "SEA OF BLUE" EFFECT

7.1 At many airports, the concentration of taxiway edge lights in the operational area often results in a confusing mass of blue lights commonly referred to as a "sea of blue". Most of the older aerodromes have added or extended taxiways but, at the same time have kept active all the old ones. It is quite normal for all of these taxiway lights to be turned on at the same time which adds to the confusion.

This problem can be reduced considerably by any of the following methods:

- a) Selective switching;

- b) Use of centre line lights;
- c) Use of lamp shielding; or
- d) Use of asymmetric lamp lenses

7.2 Selective switching is a process wherein only the edge lights on the taxiway in use are energized. This method requires additional control and switching equipment, and its effectiveness would depend on the configuration of taxiways at each particular aerodrome.

7.3 The use of green centre line lights, in lieu of edge lights, on straight sections of taxiways would also reduce the problem. However this method has the disadvantage in that the flush centre line lights are more expensive than edge lights. Further edge lights are normally installed with the centre line lights on curved portions of taxiways.

7.4 The use of shielded blue edge lights may be the less expensive method to alleviate this problem. One method of shielding is the use of special lamps which have an opaque coating applied directly onto the glass envelope. Other methods involve the use of mechanical shields attached to the outside of the lens or reflectors fitted and installed inside the lens. The latter two methods have the advantage of permitting the shield to be adjusted to suit any location.

7.5 The use of asymmetric lamp lenses is similar to shielding. The lamp lenses are designed to maximize the light intensity about a horizontal, bidirectional axis. A pilot would see the maximum intensity when approaching the light in the direction of the asymmetric axis and a minimal intensity from outside the confines of the "beam spread". This method is also inexpensive when compared to some of the other options.

8. AIR SIDE PROTECTIVE MEASURES

The purpose of the following is to provide guidelines for the provision of adequate signs, fencing and gates, where required, for the protection of aircraft while on the aerodrome movement areas, from potential conflict with pedestrians, vehicles or animals, and where

desired, arrangements for law enforcement support.

The special requirements listed in the following paragraphs are not intended to restrict or pre-empt similar requirements found in other legislation.

8.1 Determination of Protective Requirements

There are numerous types of regulatory and property signs in use on aerodromes which are designed to govern vehicular and pedestrian movements. Aerodrome operators should contact the Certifying Authority for advice regarding:

- a) the types and numbers of both property and regulatory signs that are being proposed including their location, the methods of illumination, if required, and their construction; and
- b) the locations and types of safety fencing and gates.

The aerodrome operator should ascertain if the services of the local law enforcement agencies are adequate to deal with unauthorized entry or activity upon the aerodrome.

8.2 Property Signs

Property signs should not be confused with traffic control devices. The main function of property signs is to inform the public of restrictions that are pertinent to their conduct within the aerodrome area. These signs should be treated as warning signs, and their use kept to a minimum to avoid creating a disrespect for the sign by overuse.

It would be impractical to describe every type of property sign, as specific situations often require the application of a unique sign. In some circumstances, however, it is possible to generalize and to establish standards.

The design of property signs is not as critical as that of traffic control signs as, generally, property signs are not required to be read from a moving vehicle.

8.2.1 Location of Property Signs. Property signs are normally located on the perimeter, or at selected locations within the aerodrome property,

and should be positioned where they can be easily seen by the public. Property signs should not be in a position where they may be confused with or obstruct roadway traffic control devices.

The signs may be mounted on standard supports or, where feasible affixed to fences, buildings, etc., thereby minimizing costs.

8.2.2 Commonly Used Signs

a) Danger High Voltage

The DANGER HIGH VOLTAGE sign shall be used to warn of areas where the presence of a high voltage electricity is a potential hazard. The signs shall be conspicuously placed on the outside of buildings, fenced enclosures, etc.

b) Fire Training Area

The FIRE TRAINING AREA KEEP OUT sign should be used to warn of areas where fire training operations are conducted which could be hazardous to unauthorized personnel. The signs should be installed on the periphery of the enclosed areas or at other prominent locations.

c) Authorized Persons Only

The AUTHORIZED PERSONS ONLY sign should be used at points of access to a restricted area to indicate that the area is not open to the general public. Authorized persons are those persons approved by the aerodrome operator and issued with a Designated Pass, or included on an access control list.

d) Restricted Area

The RESTRICTED AREA sign should be used to delineate sensitive and critical areas surrounding electronic instrumentation used for Category 11 approaches on the Instrument Landing System (ILS). Since vehicles in critical or sensitive areas might jeopardize approach, clearance from the control tower is required prior to entry into the area.

Due to the positioning of these signs in areas where metal may have a deleterious effect on

the electronic equipment, wooden sign planks and posts should be used.

Service roads accessing the sensitive or critical areas should be signed with NO STOPPING signs prior to the sensitive or critical areas. Since these signs are outside the sensitive or critical areas wooden signs and posts are not necessarily required.

e) No Trespassing

The NO TRESPASSING sign shall be used to give notice that trespassing on the airport property is prohibited. It is installed normally on the periphery of the aerodrome either on the boundary fence at approximately 150 m intervals, or at other prominent locations where it is readily visible to the public.

f) No Hunting

The NO HUNTING sign should be used to prohibit hunting on the aerodrome property. In most cases, this sign can be considered as supplementary to the NO TRESPASSING sign.

g) No Shooting

The NO SHOOTING sign should be used to prohibit the discharging of firearms on the aerodrome property. In most cases, this sign shall be considered as supplementary to the NO TRESPASSING sign.

h) No Fishing

The NO FISHING sign should be used where people fishing may constitute a traffic hazard.

i) No Smoking

The NO SMOKING sign should be used to define areas where smoking is not permitted. The sign should be installed on fences, doorways, or other prominent locations at the boundary of the area where smoking is prohibited.

8.3 **Regulatory signs**

Regulatory signs should be used to inform motorists and pedestrians of certain regulations

governing vehicular and pedestrian movements on aerodrome roadways, and to provide a necessary means of identifying applicable legal requirements that otherwise may not be apparent.

8.3.1 Location of Regulatory Signs.

Regulatory signs should be erected at those locations where the regulations apply and should be mounted in a position where they are plainly visible. Certain signs (generally those which control traffic movements) should be installed where they will have visual priority over all other types of signs. Signs that have been erected but are no longer applicable should be removed.

8.3.2 Commonly Used Signs

a) Stop

The STOP sign should be used at intersections of two or more roadways where traffic is required to stop before entering the intersection. In general, these signs are used in the following circumstances:

- (a) at the intersection of a side street with a through road; and
- (b) at a minor intersection where, due to a restricted view, the safe vehicle approach speed is less than 15 km/h, and the accident experience indicates the need for a STOP sign control.

STOP signs should not be erected at intersections where traffic signals are present.

STOP signs should be installed facing the direction of flow of the lesser volume of traffic at an intersection and should be supplemented by a pavement stop-line marking where the approach road is paved. Where there is doubt as to the major flow of traffic, a thorough study should be performed.

Oversized signs (750 mm x 750 mm or 900 mm x 900 mm) (29" x 29" or 35" x 35") may be used at intersections in special circumstances where more than average attention value is required of the sign. Normally, such signs should be installed only after a survey of the operating conditions at an intersection. An additional sign may be placed on the left side of a one way or channelized approach road for greater emphasis of this control.

This sign should always be located at the point where the vehicle is to stop, or as near thereto as possible. This sign should generally be erected not less than 2 m (6.5') and not more than 15 m (50') from the near edge of the nearest traffic lane of the through roadway.

b) Stop Line

The STOP LINE sign should be used at intersections controlled by traffic signals or a STOP sign, where the record of observance of the stop line pavement marking is poor, or where the location of a stop line requires greater emphasis because of irregularly shaped intersections.

The sign should be located adjacent to the outer edge of the pavement stop line.

c) Yield

The YIELD symbol sign should be installed at intersections where the normal right of way rule does not provide sufficient control for traffic entering from a minor road, and the use of a STOP/ARRET sign would be too restrictive. The effective use of the YIELD sign is dependent on low traffic volume conditions and adequate approach speed visibility. YIELD signs should not be installed at intersections with safe approach speeds of less than 15 km/h.

The YIELD sign may also be used where a separate one way right turn lane at a channelized intersection, or an interchange ramp, enters the main roadway without an adequate lane to allow for acceleration up to the speed of through traffic.

d) Do Not Enter

The DO NOT ENTER symbol sign should be conspicuously placed at the end of a one way roadway or ramp to prohibit traffic from entering the restricted area in the wrong direction.

At intersections where the use of these signs alone does not prove to be effective they may be supplemented by the Turn (R-II) sign mounted in a near right location, or adjacent to the appropriate traffic signal head.

Where required at intersections, the DO NOT ENTER sign should be placed at the far corners. At signalized intersections the sign should be placed adjacent to the signal heads governing the traffic to which the sign applies.

f) Snowmobiles Prohibited

The SNOWMOBILES PROHIBITED sign should be used on roadways at entrances to roadways or other areas where snowmobiles are prohibited.

8.4 Fence and Gates

A fence should be provided to define an area required to be rendered safe from:

- (a) inadvertent entry by persons;
- (b) entry by small children;
- (c) undetected entry by vehicles;
- (d) entry by animals; and
- (e) results of jet/propeller blast.

8.4.1 Construction. A fence should normally be 2 m high, non-climbable, of watchman or equivalent (i.e. natural barriers) or other type fabric, such as plastic where navigation aids are affected. The heights, fabric, and openings should be adjusted to local conditions as required where communication, navigational aid or radar equipment performance is affected.

8.4.2 Special wildlife problems. Consideration may be given to raising sections of the fence in an affected area to a height of 4 m if the fence has proven ineffective against wildlife after the securing of all openings in the fence and gaps under the fence in excess of 10 cm. If this is not practical, then, other alternatives (e.g. the double fence concept) may need to be considered where the above is not practical.

Note.— Where the top of a fence is less than 1.5m below the takeoff/approach surface described in Chapter 4, marking in accordance with the specifications contained in Chapter 6 will be required. Plastic strips coloured international orange have proven to be useful in this application. Consideration should also be given to marking the top of the fence with red obstruction lights where night operations are conducted.

8.4.3 Gates. The following tabulation has proven useful in determining the type of gate required for a particular application:

<u>Frequency of use</u>	<u>Type(s) of Gate</u>
1-20 openings/day	manual swing gate with padlock
20-50 openings/day	manual slide gate with padlock
50-100 openings/day	automated slide gate
100 or more openings/day	manned operation (local or remote).

Where a fire route crosses a fence, the gate should be designed to be frangible and to give way to fire fighting vehicles.

9. QUALITY ASSURANCE TESTS FOR AIRSIDE GUIDANCE SIGNS

The following paragraphs are intended to provide guidance to aerodrome operators and aerodrome visual aid manufacturers as to the tests that may be performed to demonstrate compliance with the relevant specifications contained in Section 5.4 and Appendix C.

9.1 Visual Examination

For this test, the sample sign shall have at least two message elements, with arrows, and separated by a message divider. Mandatory instruction signs shall have a single message that, for example... "18-36". The location sign shall have a single message that, for example... "B".

The signs shall be visually examined for compliance with the requirements of dimensions, component ratings, materials, finish and quality of workmanship.

At the discretion of the Certifying Authority, the signs shall be tested, under day and night conditions at distances of 250 m for discernability and 180 m for message readability.

The sign face and retroreflective material shall appear to be smooth and shall be free of any aberration (except at the panel joints of modular

signs). The panel joints shall not interfere with the legibility of the sign, leak light, or otherwise would cause a discontinuous colour across the joint.

The signs shall be illuminated with power supply that simulates an actual field installation.

9.2 Frangibility and Withstand Tests

9.2.1 General. A sample sign shall be tested to verify its performance for to meet the requirements of withstand and frangibility for wind loadings of 320 km/hr and 480 km/hr respectively, with 1200 mm clearance.

The sign may be tested at the component level. That is, the test may be performed on a mounting leg with the applied moment determined through means of calculation...given the silhouette area of the sign body (including the frame) and with the applied force considered as being concentrated at the mid-point of the sign face. The sign body (face panel and frame) shall be tested separately to determine the ability to withstand at least the loading required for frangibility.

9.2.2 Withstand Test, Sign Body. A static load shall be applied progressively to the calculated value for withstand and held at this level for 10 minutes. The load shall then be released and the face panel and frame examined for evidence of damage. Any breakage or deformation shall be cause for rejection.

9.2.3 Withstand Test, Mounting Legs. A static moment shall be progressively applied to the mounting legs to the calculated value for the 1200 mm clearance height. Where the sign construction is such that the mounting legs would act independently, half the wind loading force may be used to determine the applied moment. Where the sign construction is such that the mounting legs do not act independently, a factor shall be incorporated to account for the structural effect. The moment shall be applied to the required wind loading and held for 10 minutes. The load shall then be released and the mounting legs examined for evidence of damage. Any breakage or deformation shall be cause for rejection.

9.2.4 Frangibility Test, Mounting Legs. The static load shall be increased to the point at which the mounting legs break, deform, or yield in a manner which would drop the sign body to ground

level. This loading shall not exceed that produced by a wind loading of 480 km/hr.

9.2.5 Spring Mounted Signs, Withstand Test. Withstand tests shall be performed to verify conformance to Appendix C para. C.1.3.7.

9.2.6 Spring Mounted Signs, Frangibility Test. Signs designed to swing shall be locked to prevent movement during the frangibility test. A static load of article [9.2.5] shall be progressively increased until the mounting breaks, deforms or yields. This loading shall not exceed that produced by a wind loading of 480 km/hr.

9.3 Photometric Test

9.3.1 Internally illuminated signs. A photometer capable of measuring cd/m^2 or foot-lamberts shall be used for this test. Prior to testing the photometer shall be colour-corrected and calibrated in accordance with IES LM-52.

The system shall be designed to measure a "spot" on the sign face of 38 mm (1.5 inches) in diameter.

The sign shall be installed as intended for field application and the measurements taken with assumption of the sign face panel being vertical. For signs having face panels that are inclined from the vertical or with a curvature, the measured values of luminance shall be decreased by the cosine of the angle of inclination or curvature.

The sign being tested shall be without a legend and measurement taken only for a blank face panel having a yellow colour (directional and location signs) or white colour (mandatory signs).

Measurements shall be taken on a 75 mm (3 inch) grid as shown in Appendix C, Figure C-3. No measurement shall be taken closer than 75 mm to the sign edge/frame. The measured values shall be added together and divided by the number of measurements to determine the average.

The average value of luminance shall be between 30 and 100 cd/m^2 . Adjacent measurements on the grid shall have a ratio of values not in excess of 1.5 to 1.

Measurement shall be taken for the range of electrical characteristics of the field circuit. For example, measurement shall be taken for current

range from 2.8 to 6.6 amperes. The sign luminance shall meet the photometric requirement over this range.

For this test the manufacturer shall provide either a power supply that simulates the above current range, or information as to the lamp electrical characters during operation over this range under actual field conditions.

Note.— This test also applies to externally illuminated signs.

9.3.2 Fibreoptic signs. A photometer capable of measuring intensity in candelas shall be used for this test. Prior to testing the photometer shall be colour-corrected and calibrated in accordance with IES LM-52.

Measurement shall be taken with the fibreoptic system having a blue filter to produce a "lunar white" colour.

The angle of view and distance of measurement shall be sufficient to obtain the intensity output of 8 fibreoptic points. The points shall have a vertical orientation. For example, a portion of the numeral "1", with additional fibreoptic points blanked out.

Measurement shall be taken of the peak intensity (100 percent) and at one degree increments in the vertical and horizontal directions. The photometric performance shall conform to that shown in Appendix C, Figure C-4, over the specified current range (2.8 to 6.6 amperes).

The obtained values shall conform to the distribution shown in Appendix C, Figure C-4, within a cone of +/- one degree and +/- 25 percent of the intensity value. For example, the measured value of 1.5 candelas at 9 degrees is accepted as meeting the requirement of 2.0 candelas at 10 degrees.

Figure C-4 assumes the sign face panel to be vertical when field installed. Certain sign designs may have the face panel inclined from the vertical or with a curvature away from the vertical. In these instances, the measurements may be taken with respect to a perpendicular to the sign face and the values of intensity shall be plotted for the measured angle plus the angle of inclination. For example, with an inclination of 10 degrees, a value of 1.0 candelas at 20 degrees is plotted as 1.0

candelas at 30 degrees. Similarly a value measured at -10 degrees is plotted as being at zero degrees.

9.4 Rain Test

A rain test shall be conducted in accordance with MIL-STD-810, Procedure I. The sign shall be operated during the last 10 minutes of the test. Failure of the sign to operate shall be cause for rejection.

9.5 High Temperature Test

A high temperature test shall be conducted on the sign in accordance with MIL-STD-810, Procedure II. The maximum chamber temperature shall be 55 degrees Celsius. Failure of the unit to operate or evidence of damage shall be cause for rejection.

9.6 Low Temperature Test

A low temperature test shall be conducted on the sign in accordance with MIL-STD-810, Procedure I. The lowest operating temperature shall be minus 55 degrees Celsius. Failure of lighted signs to operate or failure to reach normal sign illumination with 2 minutes after it is energized shall be cause for rejection. Any cracking, peeling, delaminating or structural damage of the equipment shall also be cause for rejection.

9.7 Trial Installation Test

At the discretion of the Certifying Authority, the sign shall undergo a trial installation at an airport selected by the Certifying Authority for a period which verifies the suitability of the product under Winter conditions.