



Fisheries and Oceans
Canada

Pêches et Océans
Canada

Coast Guard

Garde côtière

SAR SEAMANSHIP REFERENCE MANUAL



©Her Majesty the Queen in Right of Canada, represented by
the Minister of Public Works and Government Services, 2000.

Cat. No.: FS23-392/2000E

ISBN 0-660-18352-8

First Edition – November 2000

Available through your local book seller or by mail from
Canadian Government Publishing
Public Works and Government Services Canada
Ottawa, Ontario
K1A 0S9

Telephone: (819) 956-4800

Fax: (819) 994-1498

Orders only: 1-800-635-7943

Internet: <http://publications.pwgsc.gc.ca>

Also available on the CCG Web site:

<http://www.ccg-gcc.gc.ca>

Produced by:

Fisheries and Oceans Canada

Canadian Coast Guard

Search and Rescue

Ottawa, Ontario

K1A 0E6

Disponible en français

FOREWORD

This SAR Seamanship Reference Manual is published under the authority of the Manager, Search and Rescue, of the Canadian Coast Guard. Funds associated for the development of this manual were provided by a generous contribution from the National SAR Secretariat's New SAR Initiatives Fund program. Without this financial contribution, the publication of this manual would not have been possible.

Purpose

To be able to perform safely and effectively, a rescue mission involves a huge amount of operational knowledge. Most of that knowledge is already available. However, in the context of small vessels, it is dispersed under a number of specialised and individually prepared courses or, under bits of documented information. In addition, the background and theory that sustains SAR operational knowledge is in many cases developed for larger ships involved in offshore rescue. Although the information is helpful, it does not always reflect the reality of small boat operations. A prime example would be first aid where all courses are developed around a movement free stable ground, which is quite different from a small bouncing boat deck.

Another issue is standardisation. Search and Rescue is essentially a humanitarian activity with the prime purpose of saving lives. In most cases, it involves the participation of number of dedicated people that may not have the same background. In order to make operations more efficient, it is paramount to have people executing operational tasks the same way. Therefore, this manual is aiming at introducing and standardising small boat operations for SAR. In fact, the purpose is to bring together under one manual all known best operational procedures and practices that usually apply to small boat involved in a SAR mission.

This manual targets two main groups of small boat rescuers. One is the Canadian Coast Guard Auxiliary and the other one is the Canadian Coast Guard Inshore Rescue Boat Program. However, other organized response units such a local Fire Department can certainly benefit from this manual. We hope that it will incorporate and standardise the current best practices employed within the Canadian Coast Guard operations community. It is intended to be the primary reference for the above noted two targeted groups, mainly for shore based boat operations and seamanship training.

The standardised methods and procedures presented in this Manual can apply to all boat operations and crew training and, Commanding Officers, Officers in Charge or Coxswains are encouraged to ensure that personnel tasked with boat crew responsibilities are trained or familiar in all methods and procedures in the Manual.

As the scope of this knowledge is quite vast, it will be under continuous review and will be updated as necessary. In addition, errors, omissions or suggestions should be forwarded to:

Manager, Search and Rescue, Canadian Coast Guard
Department of Fisheries and Oceans
200 Kent Street, Station 5041
Ottawa, Ontario, CANADA K1A 0E6

PEOPLE INVOLVED**ACKNOWLEDGEMENTS**

This manual would not have been possible without the co-operation of several individuals involved in Search and Rescue, many of whom are mentioned in the following list.

Étienne Beaulé, First aid and technical writing consultant
 Allen Bilodeau, Project manager
 Mathieu Vachon, Project manager

TEAM SAR OTTAWA

Ron Miller
 Mike Voigt
 Steve Daoust
 François Vézina
 Johanne Clouâtre
 Brian Leblanc
 Neil Peet
 Kathy Needham

REVIEW AND CONSULTATION**CANADIAN COAST GUARD**

Kevin Tomsett
 Dave Dahlgren
 Greg Sladics
 Herman Goulet
 Charles Lever
 Stephen Sheppard
 Howard Kearley
 Mike Taber
 Deborah Bowes-Lyon
 Mark Gagnon
 Gaétan Gamelin
 Pierre Bossé
 Pierre Domingue
 Chris Moller
 Geoff Sanders
 Bill Mather

CANADIAN COAST GUARD AUXILIARY

Harry Strong
 Garry Masson
 Ed Bruce
 Rick Tolonen
 Rudolph Mulack
 Guy Poirier
 Ted Smith
 Jim Gram
 Murray Miner
 Cal Peyton
 Ed Fulawka
 Hubert Charlebois
 Duff Dwyer
 Don Limoges
 Jack Kennedy
 Don Mertes
 Marvyn Huffman
 Jim Presgrave
 Robert Petitpas
 Sylvio Lagacé
 Gilbert Léger

Jeanne Drolet
Jean Péloquin
Marie-France Lavoie
Gaétan Létourneau
Bill Fullerton
Richard Wedge
Lois Drummond
Bruce Falkins

INSHORE RESCUE BOAT (PROGRAM)

Mike Cass
Liz Brayshaw
Jen Schnarr
Danielle Dillon
Amy Birchall
Andrew Boyd
Casey Wilson
Tina Sweet
Darryl McKenzie
Marie Tremblay
Sophie-Émanuelle Genest
Nathalie Desjardins
John Johnstone
Scott Davis
Tim Church
Heather Goodwind
David Latremouille
Aaron Macknight
Chris Evers
Steven Shea
Dan Latremouille
Dana Sweeney
Steven Dickie
Gavin Moore
David Willis

OTHER THANKS

The Gordon Creative Group
Point-virgule, inc. (French editing)
Maureen McMahon
(revised English edition)
Mario Boucher
(Institut Maurice-Lamontagne)

ABBREVIATIONS AND ACRONYMS

NOTE: The abbreviations are listed alphabetically in the first column, with the French equivalent in brackets. Bold characters indicate that the abbreviation is the same in both languages.

AMVER	Automated Mutual Assistance Vessel Rescue System
CASARA (ACRSA)	Civil Air Search and Rescue Association
CCG (GCC)	Canadian Coast Guard
CCGS (NGCC)	Canadian Coast Guard Ship
CCGA (GCAC)	Canadian Coast Guard Auxiliary
CF (FC)	Canadian Forces
CGRS (SRGC)	Coast Guard Radio Station
COSPAS	Russian for: Space system search for distressed vessels
CSA (LMMC)	Canada Shipping Act
CSS	Co-ordinator surface search
DF	Direction finder
DFO (MPO)	Department of Fisheries and Oceans
DND (MDN)	Department of National Defence
DMB	Data marker buoy
DSC (ASN)	Digital selective calling
ECAREG Canada	Eastern Canada Traffic Zone Regulations
ELT	Emergency locator transmitter
EPIRB (RLS)	Emergency position-indicating radio beacon
ETA (HPA)	Estimated time of arrival
FRC (ERS)	Fast rescue craft
F/V (B/P)	Fishing vessel
GMDSS (SMDSM)	Global Maritime Distress and Safety System
GPS	Global Positioning System
IMO (OMI)	International Maritime Organisation
Inmarsat	International Mobile Satellite Organisation
IRB (ESC)	Inshore rescue boat
kt (nd)	Knot (nautical mile per hour)
LKP	Last known position
m	Metre
MCTS (SCTM)	Marine Communications and Traffic Services Centre
MARB	Maritime assistance request broadcast
Medevac	Medical evacuation
MSI	Maritime safety information
MRSC	Maritime rescue sub-centre
M/V (N/M)	Merchant vessel or motor vessel
NM (MN)	Nautical mile
NSS (SNRS)	National Search and Rescue Secretariat
OBS (BSN)	Office of Boating Safety
OSC	On-scene co-ordinator

PIW	Person in water
PLB	Personal locator beacon
POB	Persons on board
RCC	Rescue co-ordination centre
SAR	Search and Rescue
SARSAT	Search and Rescue Satellite-Aided Tracking
SART	Search and rescue (radar) transponder
SERABEC	Sauvetage et recherche aériens du Québec
SITREP	Situation Report
SKAD	Survival kit air droppable
SLDMB	Self-locating datum maker buoy
SMC	Search and rescue mission co-ordinator
SOLAS	International Convention of the Safety of Life at Sea
SRR	Search and rescue region
SRU	Search and rescue unit
S/V (B/V)	Sailing vessel
UTC	Co-ordinated universal time
VTS (STM)	Vessel traffic services
VHF	Very high frequency (30 to 300 MHz)

TABLE OF CONTENTS

Abbreviations and acronymsiv
Chapter 1: Maritime SAR in Canada1-1
Who is involved?	I-3
How is maritime SAR delivered in Canada?	I-5
Vessels	I-6
Rescue co-ordination and alerting	I-8
Canadian Coast Guard program effectiveness	I-15
Unnecessary use of the SAR system	I-15
Partnership and team approach to search and rescue	I-15
Who should be called first	I-17
Chapter 2: Human factors2-1
Why spend time discussing human factors?	2-3
Profile of a good SAR team	2-3
Image and attitude	2-19
Critical-incident stress management	2-24
Chapter 3: Personal safety3-1
General	3-3
Protection in cold water	3-3
Personal safety equipment	3-7
Chapter 4: Vessel safety4-1
Checklists and inspection of equipment	4-3
Maintenance and repairs	4-11
SAR equipment	4-36
Trailing a boat	4-38
On board emergencies	4-42
Chapter 5: Seamanship and terminology5-1
Boat terminology	5-5
Types of boats	5-11
Boat Motions	5-25
Ropes	5-25
Knots, bends, hitches and related items	5-30
Wire rope	5-38
Working with ropes, lines and wires	5-43
Chapter 6: Navigation safety6-1
Collision regulations	6-3
Lookout procedures	6-7
Aids to navigation	6-16

Chapter 7:	Navigation7-1
	Navigating with charts7-3
	Electronic navigation7-19
Chapter 8:	Waves and weather8-1
	Wave theory8-3
	Understanding weather8-14
Chapter 9:	Boat handling9-1
	General9-5
	The art of boat handling9-5
	Environmental forces acting on a boat9-6
	Propulsion and steering9-9
	Boat handling characteristics9-17
	Types of hull9-21
	Basic boat handling techniques9-28
	Advanced boat handling techniques9-38
	Heavy weather boat handling9-45
Chapter 10:	Towing10-1
	General10-5
	Safety10-5
	Forces in towing10-6
	Towing equipment10-10
	Approaching a vessel in need of towing10-17
	Use of bridles10-26
	Stern tow10-28
	Towing speed10-29
	Towing alongside10-31
	Entering a marina with a vessel in tow10-33
	Docking the alongside tow10-34
	Heavy weather towing10-35
	Towing in current10-36
	Towing aircraft10-37
	Person overboard operations with a tow astern10-38
	Tandem towing10-40
	Sinking tow and a tow on fire10-42
	Towing precautions checklist10-44
Chapter 11:	SAR operations11-1
	Awareness and initial actions11-7
	SAR stages11-7
	Emergency phases11-8
	Awareness stage: Methods for communicating distress11-9
	Initial action stage11-13
	Timing of an SAR mission11-14

SAR communications	II-14
Planning	II-16
Basic search planning	II-17
Search patterns	II-21
Conducting a search	II-30
Rescue	II-36
Grounded vessels and damage control	II-43
Rescue of capsized vessels	II-52
Removing/delivering persons from/to shore	II-62
Removing/delivering persons from/to other vessels	II-65
Aircraft rescue	II-70
Rescue operations with DND planes and helicopter	II-72
Recovering submerged victims	II-76
Mission conclusion	II-78
Chapter 12: Emergency care and transportation of maritime casualties . . .	12-1
Medical emergencies	I2-5
Water extrication	I2-9
Hypothermia	I2-11
Cold water near drowning	I2-12
Diving related injuries (SCUBA, etc.)	I2-19
Multi-casualty situations	I2-26
Spinal injuries	I2-33
Care of rescue craft survivors	I2-38
External assistance	I2-41
Transportation of casualty in Fast Rescue Craft	I2-42
References	R-1

CHAPTER 1 – MARITIME SAR IN CANADA

1.1	Who is involved?	1-3
1.1.1	Canadian Coast Guard	I-3
1.1.2	Department of National Defence	I-4
1.1.3	Interdepartmental Committee on Search and Rescue (ICSAR)	I-4
1.1.4	National Search and Rescue Secretariat (NSS)	I-5
1.2	How is maritime SAR delivered in Canada?	1-5
1.2.1	Management and monitoring	I-5
1.2.2	Operations	I-5
1.2.3	Prevention	I-5
1.2.4	Volunteers	I-5
1.3	Vessels	1-6
1.3.1	Primary SAR vessels	I-6
1.3.2	Secondary SAR vessels	I-6
1.3.3	Canadian Coast Guard Auxiliary (CCGA)	I-6
1.3.4	Vessel of opportunity	I-6
1.4	Rescue co-ordination and alerting	1-8
1.4.1	Rescue Co-ordination Centres and Maritime Rescue Sub-Centres	I-8
1.4.2	On-scene Co-ordinator / Co-ordinator Surface Search	I-10
1.4.3	Rescue alerting, detection and communications	I-10
1.4.3.1	What is GMDSS?	I-10
1.4.3.2	Why GMDSS?	I-11
1.4.3.3	GMDSS equipment	I-11
1.4.3.4	Maritime Safety Information (MSI)	I-12
1.4.3.5	GMDSS Sea Areas – International	I-12
1.4.3.6	GMDSS Sea Areas – Canada	I-13
1.4.3.7	Vessel compliance	I-13
1.4.3.8	Communications between GMDSS vessels and non-GMDSS vessels .	I-13
1.4.3.9	Canadian Coast Guard Marine Communications and Traffic Services Centres	I-13
1.4.3.10	Canadian Rescue Co-ordination Centres and Maritime Rescue Sub-Centres	I-14
1.4.3.11	Operator proficiency	I-14

1.4.4	Marine Communication and Traffic Services	I-I4
1.5	Canadian Coast Guard program effectiveness	1-15
1.6	Unnecessary use of the SAR system	1-15
1.6.1	System of last resort	I-I5
1.6.2	Ensure self-reliance	I-I5
1.7	Partnership and team approach to search and rescue	1-15
1.7.1	What is my potential contribution to a search and rescue effort? ...	I-I6
1.7.2	Your level of training	I-I6
1.7.3	The capabilities of your boat and crew	I-I6
1.7.4	Equipment on board	I-I7
1.8	Who should be called first?	1-17
1.8.1	Waters under federal responsibility	I-I7
1.8.2	Provincial responsibilities	I-I8

1 MARITIME SAR IN CANADA

At the federal level, SAR policy is co-ordinated under the National Search and Rescue Program. Its primary goal is to save lives at risk throughout Canada. This national program involves federal departments, volunteers, organisations, municipalities and, provinces and territories working together. The marine portion of this program falls under the responsibility of the Canadian Coast Guard, which intervenes with its various partners in areas of federal responsibility. These areas include coastal waters, the St. Lawrence River, the Great Lakes and the Arctic. Other areas such as inland lakes and rivers are under provincial responsibility.

The following paragraphs will outline the role and responsibilities of the Canadian Coast Guard and its partners. An explanation of the general organisation of the search and rescue system will follow.

1.1 WHO IS INVOLVED?

1.1.1 Canadian Coast Guard

The Canadian Coast Guard (CCG) is part of the Department of Fisheries and Oceans (DFO), and is the main civilian marine operational arm of the Government of Canada. In DFO, the Canadian Coast Guard operates all vessels and provides services in the following areas: search and rescue; boating safety; environmental response; icebreaking; marine navigation service; navigable waters protection; and marine communications and traffic services. The Coast Guard also provides marine support and services to departmental programs in science and fisheries conservation and protection, and to other agencies at all levels of government.

The Canadian Coast Guard (CCG) is responsible for a number of SAR tasks. These include the detection of marine incidents; the co-ordination, control, and conduct of SAR operations in maritime SAR situations within Canadian areas of federal responsibility; providing marine resources to help with air SAR operations as necessary; and, when and where available, providing SAR resources to assist in humanitarian and civil incidents within provincial, territorial or municipal areas. The CCG also co-ordinates, controls, and conducts SAR prevention and boating safety programs in all waters across Canada to reduce the number and severity of maritime SAR incidents.

The Canadian Coast Guard supplements its primary maritime SAR response element with secondary SAR vessels. In addition, the CCG oversees the activities of the Canadian Coast Guard Auxiliary (CCGA), a volunteer organisation.

1.1.2 Department of National Defence

In 1976, the Prime Minister appointed the Minister of National Defence as the Lead Minister for SAR (LMSAR). The LMSAR is responsible for the co-ordination of the National Search and Rescue Program (NSP) and the development of national SAR policies in conjunction with other ministers. The LMSAR is the designated national spokesperson and is responsible for ensuring the effective operation of the national SAR system.

DND is responsible for air SAR incidents, and delivers primary air SAR services for both air and marine incidents. It also provides a high level of secondary SAR support from its aircraft fleet, and co-ordinates the activities of the Civil Air Search and Rescue Association (CASARA), a volunteer organisation.

Under the SAR program, DND and the Canadian Coast Guard co-ordinate the response to air and maritime SAR incidents through jointly staffed Rescue Co-ordination Centres (RCCs).

1.1.3 Interdepartmental Committee on Search and Rescue (ICSAR)

The Interdepartmental Committee on Search and Rescue (ICSAR) was established in 1976 by the Cabinet to ensure the effective national co-ordination and delivery of SAR services. The various federal departments involved in SAR are represented at ICSAR. This committee reports to the Lead Minister for SAR.

ICSAR has the following mandate:

- identifying SAR requirements;
- providing advice to the government on the best methods for meeting these requirements.

The following agencies are represented by senior management at ICSAR meetings:

- Department of National Defence;
- Department of Fisheries and Oceans (Canadian Coast Guard);
- Transport Canada (Aviation);
- Solicitor General (Royal Canadian Mounted Police);
- Environment Canada (Atmospheric Environment Services);
- Canadian Heritage (Parks Canada);
- Privy Council Office;
- Treasury Board Secretariat;
- Natural Resources Canada;
- Emergency Preparedness Canada;
- Indian and Northern Affairs Canada; and
- National Search and Rescue Secretariat.

1.1.4 National Search and Rescue Secretariat (NSS)

The National Search and Rescue Secretariat (NSS) gives support and advice to the Lead Minister for SAR. NSS co-ordinates and assists in developing the National Search and Rescue Program. The executive director of the NSS chairs the Interdepartmental Committee on Search and Rescue.

1.2 HOW IS MARITIME SAR DELIVERED IN CANADA?

The Maritime SAR Program is a full-time program activity. Its main goal is to reduce the loss of life in the marine environment. The Coast Guard's SAR Program includes four important elements: management and monitoring; operations; prevention; and volunteers.

1.2.1 Management and monitoring

The goal of management and monitoring is to ensure that the SAR Program operates at maximum efficiency. To accomplish this objective, SAR coverage requirements are continuously adjusted to meet changing needs, and specialised primary SAR units are deployed as required. To further enhance response capabilities, SAR Program management co-operates with other program managers in the deployment of secondary resources. These combined efforts ensure that capable emergency services will be readily available when and where they are most likely to be needed.

1.2.2 Operations

Operations, which include search, rescue and incident co-ordination, form the heart of the maritime SAR system. Canadian Coast Guard SAR units are capable of responding to the vast majority of maritime SAR challenges found in the Canadian environment. This high level capability is delivered by skilled, professional crews (full-time, volunteers or students) using specialised vessels and equipment.

1.2.3 Prevention

The purpose of the SAR Prevention Program is to minimise loss of life and decrease the rate of incidents, thereby reducing SAR resource expenditure and risk to the public. Prevention activities focus on the clientele most commonly involved in SAR incidents. SAR Prevention is a component of the Office of Boating Safety, which also includes regulatory responsibility for recreational vessels. The Office of Boating Safety provides technical services such as approval of safety equipment and the development of construction standards for these vessels.

1.2.4 Volunteers

Volunteer assistance is a key element in maximising the efficiency of SAR operations, prevention and safety-related activities. The Canadian Coast Guard supports all forms of volunteerism relating to maritime search and rescue through the Canadian Coast Guard Auxiliary (CCGA).

1.3 VESSELS

The following categories of vessels are used in maritime SAR incidents:

1.3.1 Primary SAR vessels

A primary SAR vessel is a specially designed and equipped vessel with a trained crew that has SAR as its main task. These vessels are pre-positioned in areas with a high risk of SAR incidents. They bear the common Canadian Coast Guard red and white fleet colours with the words “RESCUE / SAUVETAGE” displayed as black, block letters against the port and starboard sides of the white superstructure. Some primary vessels, such as most Fast Rescue Crafts (FRCs), will not bear the usual colours. Instead, these vessels may be orange or yellow. The identification “RESCUE/SAUVETAGE” is usually present. All these vessels maintain a maximum 30-minute state of readiness, but are typically ready to respond immediately when an alert is received.

1.3.2 Secondary SAR vessels

Secondary SAR vessels are all other government vessels.

1.3.3 Canadian Coast Guard Auxiliary (CCGA)

The Canadian Coast Guard Auxiliary (CCGA) is a highly effective volunteer organisation made up of five non-profit associations and a national council that assists the Coast Guard in SAR response and prevention activities. Each year, a contribution agreement covers certain expenses and insurance for the Auxiliary while it is engaged in authorised SAR operations and activities. Tax-deductible donations from the public and other organisations also help fund the Auxiliary. The Canadian Coast Guard assists Auxiliary members with the specialised SAR training necessary to become and remain a member. In return, the CCG may rely on the approximately 5,000 members and 1,500 vessels of the Auxiliary to augment its maritime SAR capability as necessary.

1.3.4 Vessel of opportunity

A vessel of opportunity is any other vessel not mentioned above, but in a location close enough to provide assistance to a vessel in distress. Under the *Canada Shipping Act* and international law, every vessel at sea is required to assist in a distress situation.

EXCERPTS FROM THE *CANADA SHIPPING ACT*

Answering Distress Signal:**384 (1)**

The master of a Canadian ship at sea, on receiving a signal from any source that a ship or aircraft or survival craft thereof is in distress, shall proceed with all speed to the assistance of the persons in distress informing them if possible that he is doing so, but if he is unable or, in the special circumstance of the case, considers it is unreasonable or unnecessary to proceed to their assistance, he shall enter in the official logbook the reason for failing to proceed to the assistance of those persons.

Ship Requisitioned:**384 (2)**

The master of any ship in distress, may, after consultation, insofar as possible, with the masters of the ships that answer his distress signal, requisition one or more of those ships that he considers best able to render assistance, and it is the duty of the master of any Canadian ship that is so requisitioned to comply with the requisition by continuing to proceed with all speed to the assistance of the ship in distress.

Release From Obligation:**384 (3)**

The master of a ship shall be released from the obligation imposed by subsection (1) when he learns that one or more ships other than his own have been requisitioned and are complying with the requisition.

Further Release:**384 (4)**

The master of a ship shall be released from the obligation imposed by subsection (1), and, if his ship has been requisitioned, from the obligation imposed by subsection (2), if he is informed by the persons in the ship in distress or by the master of another ship that he has reached those persons or that assistance is no longer necessary.

Minister May Designate Rescue Co-ordinators:**385 (1)**

The Minister of National Defence may designate persons, to be known as rescue co-ordinators, to organise search and rescue operations in Canadian waters and on the high seas off the coasts of Canada.

Power of Rescue Co-ordinators:**385 (2)**

On being informed that a vessel or aircraft or survival craft thereof is in distress or is missing in Canadian waters or on the high seas off any of the coasts of Canada under circumstances that indicate it may be in distress, a rescue co-ordinator may:

- (a) order all vessels within an area specified by him to report their positions to him;
- (b) order any vessel to take part in a search for that vessel, aircraft or survival craft or to otherwise render assistance; and
- (c) give such other orders, as he deems necessary to carry out search and rescue operations for that vessel aircraft or survival craft.

1.4 RESCUE CO-ORDINATION AND ALERTING

1.4.1 Rescue Co-ordination Centres and Maritime Rescue Sub-Centres

The Canadian Coast Guard jointly staffs three Rescue Co-ordination Centres (RCCs) with the Canadian Forces. The RCCs are located at Victoria, British Columbia; Trenton, Ontario; and Halifax, Nova Scotia. The Canadian Coast Guard also operates two Maritime Rescue Sub-Centres (MRSCs) at Quebec City, Quebec and St. John's, Newfoundland. The function of an MRSC is to reduce the RCC's workload in areas of high marine activity. These centres are staffed by SAR co-ordinators who operate 24 hours a day, seven days a week, year round. The maritime area for which the Canadian RCCs/MRSCs are collectively responsible covers more than 5.3 million square kilometres.

The RCCs/MRSCs are responsible for the planning, co-ordination, conduct and control of SAR operations. RCCs/MRSCs have highly trained staff, detailed operational plans and an effective communication system. Once an RCC/MRSC is notified that a person is in danger, the SAR co-ordinator begins to organise the rescue. All available information about the person in danger is gathered and recorded, and the positions of potential assisting resources in the area of the incident are determined. SAR co-ordinators are trained to evaluate various situations and send the most effective resources to deal with a particular incident. In complex and major incidents, many resources are often sent or tasked to assist.

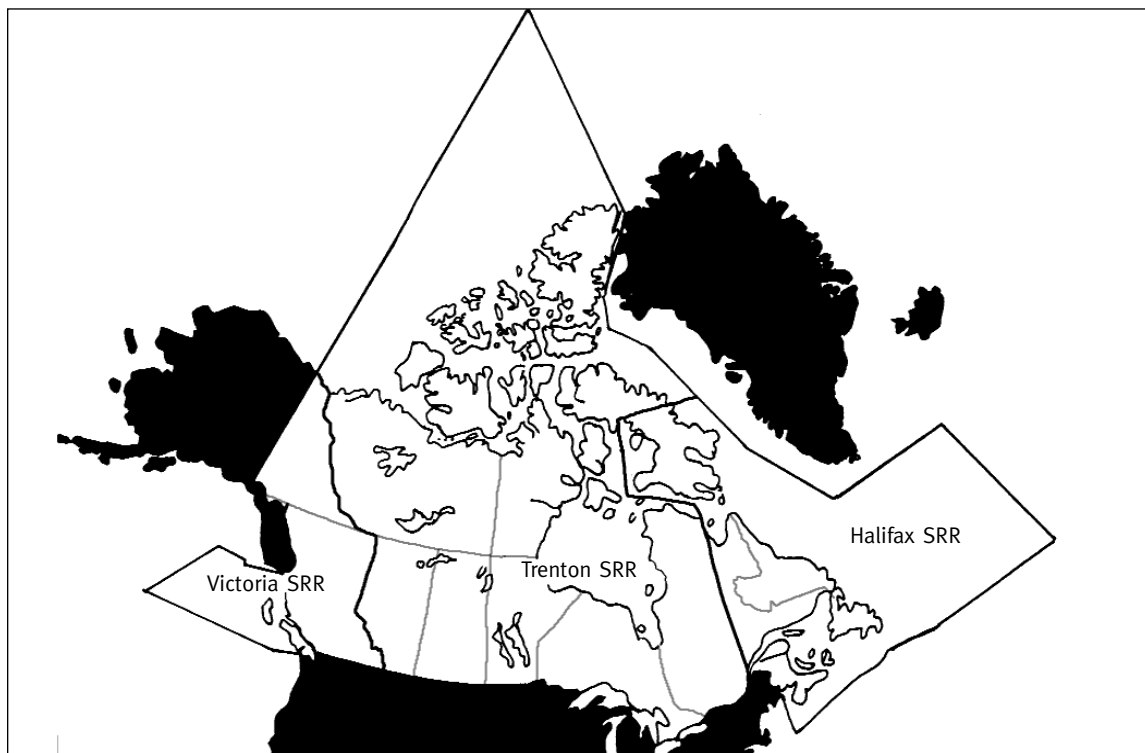

Figure 1.1: Search and rescue region boundaries

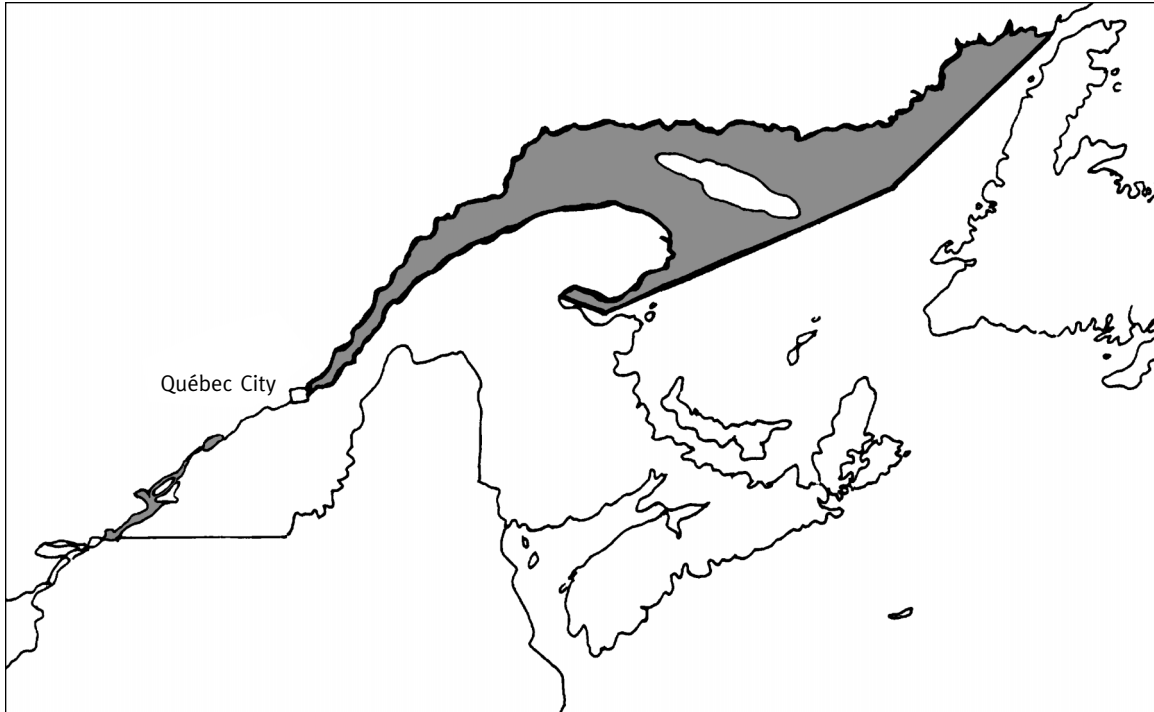

Figure 1.2: MRSC Quebec operational boundaries

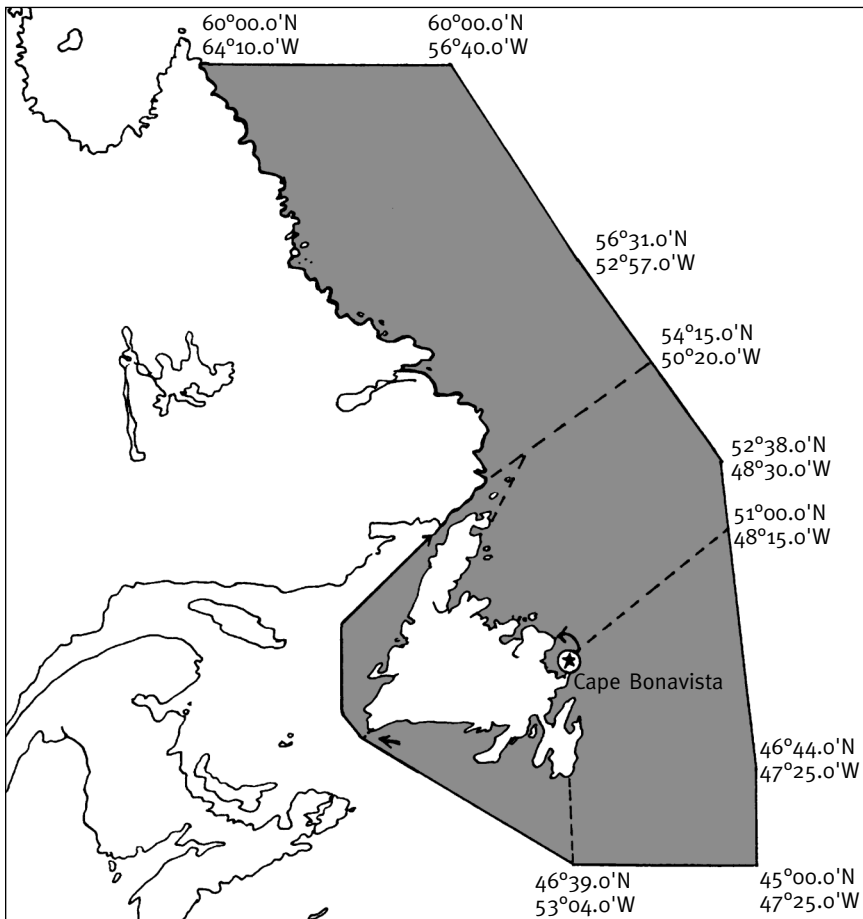

Figure 1.3: MRSC St. John's operational boundaries

1.4.2 On-scene Co-ordinator / Co-ordinator Surface Search

In major SAR operations where several rescue units respond to a call, an On-scene Co-ordinator (OSC) is normally appointed by the RCC/MRSC. An On-scene Co-ordinator is the commanding officer of a vessel or aircraft designated by RCC/MRSC to co-ordinate SAR operations within a specified area. On-scene Co-ordinator authority may be delegated to primary Coast Guard SAR vessels, DND aircraft, secondary Coast Guard vessels or other government vessels which have suitable equipment and trained personnel for the expeditious conduct of SAR operations.

If a suitable government vessel is not available to assume the duties of On-scene Co-ordinator, RCC/MRSC may ask another ship participating in the operation to assume the responsibilities of Co-ordinator Surface Search (CSS).

Where an OSC or CSS has been designated, the OSC/CSS shall be responsible for the following tasks to the extent they have not been performed by the responsible RCC/MRSC:

- Carry out the plan for the conduct of the operations as requested by the RCC/MRSC.
- Modify the plan as facilities and on-scene conditions dictate and inform the RCC/MRSC of any such modifications.
- Monitor weather and sea conditions and report on these at regular intervals to the RCC/MRSC.
- Maintain communications with the RCC/MRSC and the SAR units on the scene.
- Maintain a detailed record of the operation, including on-scene arrival and departure times of SAR units areas searched, track spacing used, sightings and leads reported, actions taken and results obtained.
- Issue regular situation reports to the RCC/MRSC which should include, but not be limited to, weather and sea conditions, the results of search to date, any actions taken, and any future plans or recommendations.
- Advise RCC/MRSC to release units when their assistance is no longer required.

1.4.3 Rescue alerting, detection and communications

Visual, audio and electronic methods are used by vessels to indicate distress. Visual methods include items such as distress flares and international signal flags. Audio methods include radios and beacons. The following are a few highlights:

1.4.3.1 What is GMDSS?

The Global Maritime Distress and Safety System (GMDSS) is a new international system using improved terrestrial and satellite technology and shipboard radio systems. It ensures rapid alerting of shore-based rescue and communications authorities in the event of an emergency. In addition, the system alerts vessels in the immediate vicinity and provides improved means of locating survivors.

GMDSS was developed through the International Maritime Organisation (IMO) and represents a significant change in the way maritime safety communications are conducted. While it is mandatory for all ships subject to the International Convention for the Safety of

Life at Sea (SOLAS) (cargo ships 300 gross tons or greater and all passenger vessels on international voyages), GMDSS will impact on all radio-equipped vessels, regardless of size. All SOLAS ships were required to comply with GMDSS by February 1, 1999.

1.4.3.2 Why GMDSS?

GMDSS was developed to SAVE LIVES by modernising and enhancing the current radio-communications system. By utilising satellite and digital selective calling technology, GMDSS provides a more effective distress alerting system. It improves the current system by:

- increasing the probability that an alert will be sent when a vessel is in distress;
- increasing the likelihood that the alert will be received;
- increasing the capacity to locate survivors;
- improving rescue communications and co-ordination; and
- providing mariners with vital maritime safety information.

1.4.3.3 GMDSS equipment

Digital Selective Calling (DSC)

Traditional marine radio (VHF/MF/HF) has been enhanced with the addition of a feature known as DSC. This feature enables vessels to automatically maintain the required watch on distress and calling channels instead of the current aural listening watch. A DSC receiver will only respond to the vessel's unique Maritime Mobile Service Identity number (MMSI#), similar to a telephone number, or to an "All Ships" DSC call within range. Once contact has been made by DSC, follow-up communications take place by voice on another frequency.

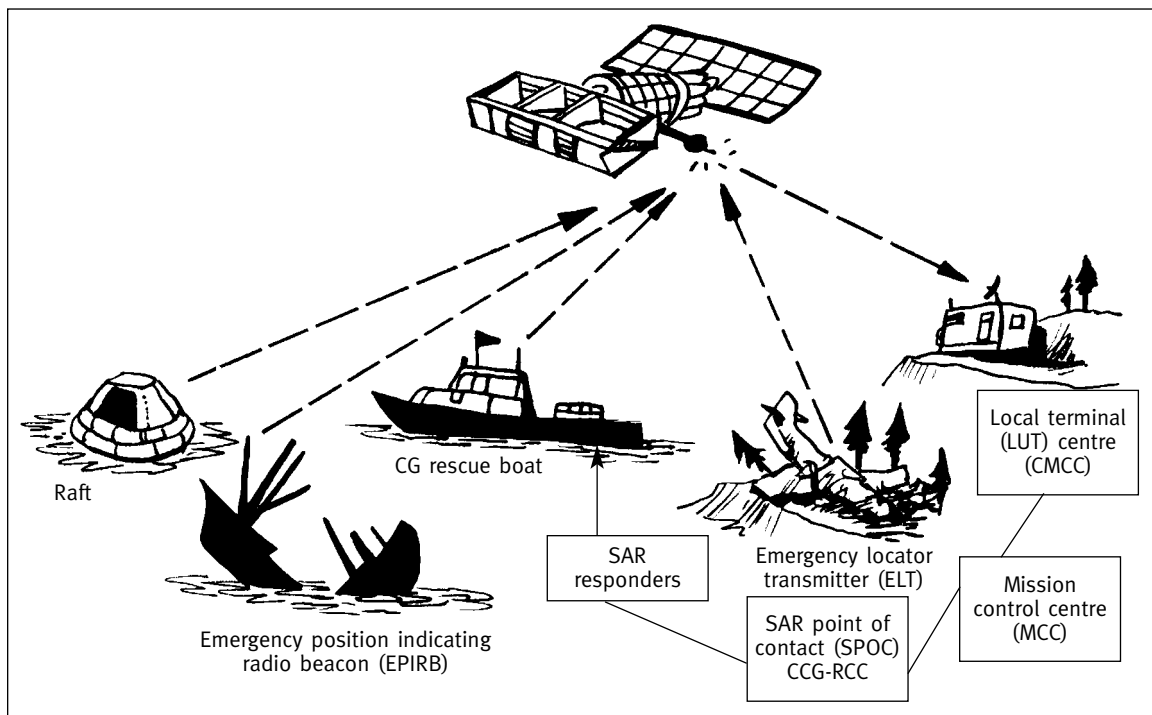

Figure 1.4: EPIRB System Operation

Satellite communications

The Inmarsat satellite network provides global communications everywhere except for polar regions. In areas without any VHF or MF DSC shore facilities, Inmarsat A, B or C terminals are used for distress alerting and communications between ship and shore. Inmarsat provides an efficient means of routing distress alerts to Search and Rescue (SAR) authorities.

Emergency Position Indicating Radio Beacon (EPIRB)

GMDSS makes use of the COSPAS-SARSAT Satellite System, which provides global detection of 406 Megahertz (MHz) EPIRBs. These beacons are small, portable, buoyant, and provide an effective means of issuing a distress alert anywhere in the world. Float-free EPIRBs (class 1) have been required on most Canadian commercial vessels 20m or more in length since 1989, and are highly recommended for all vessels. Owners must register these EPIRBs in the national beacon database (1-800-727-9414).

Search and Rescue Transponder (SART)

SARTs are portable radar transponders used to help locate survivors of distressed vessels that have sent a distress alert. These transponders are detected by radar, and therefore operate in the same frequency range as radars carried on board most vessels. SARTs transmit in response to received radar signals, and show up on a vessel's radar screen as a series of dots, accurately indicating the position of the SART. In the event that a ship must be abandoned, SARTs should be taken aboard survival craft.

1.4.3.4 Maritime Safety Information (MSI)

Maritime Safety Information broadcasts, which include distress alerts, SAR information, navigational and weather warnings, as well as forecasts, can be received in three different ways in GMDSS:

- NAVTEX receivers are fully automatic and receive broadcasts in coastal regions up to 300 nautical miles off shore.
- Inmarsat-C terminals receive Enhanced Group Call – SafetyNET (EGC) broadcasts for areas outside NAVTEX coverage.
- HF Narrow Band Direct Printing (NBDP) receivers can be used where service is available as an alternate to EGC.

1.4.3.5 GMDSS Sea Areas – International

Although ship-to-ship alerting is still an important function in GMDSS, the emphasis is on two-way communications between ships and shore facilities. All GMDSS ships must be capable of communicating with the shore and transmitting a distress alert by two different means. Its area of operation and the availability of shore-based communications services therefore determine the equipment carried by a GMDSS ship.

There are four “Sea Areas” defined in the GMDSS:

- Sea Area A1: within range of a shore-based VHF DSC coast station (40 nautical miles)
- Sea Area A2: within range of a shore-based MF DSC coast station; excluding sea areas A1 (150 nautical miles)

- Sea Area A3: within the coverage of an Inmarsat geo-stationary satellite; approximately 70°N to 70°S (excluding sea areas A1 and A2)
- Sea Area A4: the remaining areas outside sea areas A1, A2 and A3 (polar regions)

1.4.3.6 GMDSS Sea Areas – Canada

In Canada, as a result of consultations with the Canadian marine industry, it has been decided to implement sea area A1 on the east and west coasts. Outside of A1 will be an A3 sea area, with an A4 sea area in the Arctic.

Consideration was given to the implementation of an A2 sea area, but due to budgetary constraints and the marine industry's preference for sea areas A1 and A3, sea area A2 is not being planned at this time, nor are sea areas for the Great Lakes and St. Lawrence River.

On Canada's east and west coasts, VHF DSC implementation was scheduled to begin in 1998 to cover the busiest areas. Full implementation, similar to today's VHF coverage, is planned for 2002.

1.4.3.7 Vessel compliance

GMDSS requirements for all SOLAS ships on international voyages have been established by the IMO. The date set for full compliance was February 1, 1999.

Requirements for Canadian commercial vessels not subject to SOLAS are currently being developed in consultation with the marine industry through the Canadian Marine Advisory Council (CMAC).

The carriage of GMDSS equipment on pleasure craft will not be mandatory; however, it is recommended that they carry GMDSS equipment applicable to their area of operation. For additional safety, vessels equipped with Global Positioning System (GPS) or LORAN-C are encouraged to connect this equipment to DSC and/or satellite communications equipment capable of transmitting a pre-formatted distress alert.

1.4.3.8 Communications between GMDSS vessels and non-GMDSS vessels

After February 1, 1999, GMDSS ships will be maintaining an automated listening watch on VHF DSC channel 70 and MF DSC 2187.5 kHz. During the transition to GMDSS, vessels fitted with traditional, non-GMDSS radio equipment may have difficulty alerting or contacting a GMDSS ship. The Coast Guard is addressing this temporary situation by monitoring both GMDSS and traditional distress frequencies during the transition. Although the final date for the cessation of mandatory watch-keeping on VHF channel 16 by SOLAS ships is under review by the IMO, all vessels should fit VHF DSC as soon as practicable to avoid a lengthy transition period.

1.4.3.9 Canadian Coast Guard Marine Communications and Traffic Services (MCTS) Centres

To help ease the transition to GMDSS and bridge the communication gap between the two systems, Canadian Coast Guard MCTS Centres will continue to monitor VHF channel 16

and MF 2182 kHz, the current distress and safety channels, until at least 2003. Once Canada's sea areas have all completed the transition, lower cost DSC equipment is available, and these services are judged no longer necessary, these listening watches will be discontinued.

To supplement the broadcasting of Maritime Safety Information (MSI) on NAVTEX and INMARSAT EGC, MCTS Centres will continue safety broadcasts using the existing VHF continuous marine broadcast system.

1.4.3.10 Canadian Rescue Co-ordination Centres (RCC) and Maritime Rescue Sub-Centres (MRSC)

Canadian RCCs and MRSCs will continue to receive distress alerts transmitted by vessels and relayed via MCTS or satellite. When a GMDSS distress alert is received, the centre must re-issue an "all ships" broadcast in the vicinity so that vessels in the immediate area are aware of the alert and can respond. RCC/MRSC will task aircraft and vessels at this time. If a distress alert is sent in error, the Coast Guard MCTS Centre or RCC/MRSC should be notified immediately so that these resources can be "stood-down."

1.4.3.11 Operator proficiency

A major concern for the marine community is the number of false alerts that are being experienced on some GMDSS sub-systems, especially DSC and INMARSAT-C. Since a large percentage of false alerts is attributed to a lack of operator proficiency, it is especially important that operators of GMDSS fitted vessels receive instruction in the proper operation of their GMDSS equipment. Instruction is currently available through various training institutes across Canada.

There are two GMDSS operator certificates issued by Canada:

- General Operators Certificate (GOC) – Required on most compulsory fitted GMDSS vessels operating outside sea area A1. This certificate involves a two-week training course, including a written and a practical exam.
- Restricted Operators Certificate (ROC) with Maritime Qualification – Basic certificate for operators of compulsory-fitted GMDSS vessels operating in an A1 sea area. This certificate is also recommended for operators of GMDSS equipment on voluntarily fitted vessels. This certificate is awarded on successful completion of an approved written exam.

1.4.4 Marine Communication and Traffic Services

Marine Communications and Traffic Services (MCTS) is the Branch of the Canadian Coast Guard that provides communications and vessel traffic services to the sea-going public. MCTS monitors for distress radio signals; provides the communication link between vessels in distress and the RCC/MRSC; sends safety information; handles public communication; and regulates the flow of traffic in some areas. MCTS is an important link in the SAR system.

1.5 CANADIAN COAST GUARD PROGRAM EFFECTIVENESS

Trained professionals, vessels and equipment are important elements of the maritime SAR system. SAR in Canada works well because the network is designed to monitor, co-ordinate and respond to calls for assistance as part of an integrated system. Canada has one of the most effective SAR systems in the world.

In the international community, one of the most important ways to determine the effectiveness of an SAR system is to look at the ratio of lives saved to lives at risk in marine distress. A distress situation exists when human life is in grave danger. In Canada, on average, over 90 percent of the lives at risk in marine distress, or about 3,000 lives, are saved each year. The SAR system helps another 17,000 people each year in non-distress marine incidents. During 1998, there were 5,311 maritime SAR incidents in Canada (3,530 saved).

1.6 UNNECESSARY USE OF THE SAR SYSTEM

1.6.1 System of last resort

Safety at sea is a personal responsibility. If all other methods of preventing an accident are unsuccessful, the SAR system is available as a last resort. Regulations and standards are in place to cover the construction, equipping, crewing and operations of vessels. Numerous types of learning materials, courses and institutions are available to provide valuable information to operators. The Office of Boating Safety staffs a toll-free information line (1-800-267-6687) that provides front-line contact with the boating community. Knowledge and awareness are key elements of personal responsibility and reduce the risk of accident.

1.6.2 Ensure self-reliance

The program aims to consistently ensure that clients are self-reliant and that SAR incidents are prevented. Unfortunately, abuse of the system accounts for a very small percentage of cases each year. False activation of the SAR system is a serious matter and is dealt with under the Criminal Code of Canada.

Some cases involving use of the SAR system are clearly preventable or unreasonable. These cases cost the taxpayers of Canada, but more importantly, they involve resources that may be needed for genuine SAR and may place the rescuers in unnecessary danger. Currently, the Canadian Coast Guard is looking at ways to prevent the occurrence of these types of cases.

1.7 PARTNERSHIP AND TEAM APPROACH TO SEARCH AND RESCUE

As indicated in the previous section, maritime search and rescue involves the co-ordinated efforts of many players. The key words here are really “co-ordinated efforts.” Anyone wishing to become a valuable asset to this co-ordinated effort must understand that search and rescue involves a team and a system approach. Except for a few highly unusual cases, someone acting individually, no matter how qualified or equipped, will always be ineffective in a search and rescue effort. On the other hand, someone doing his or her small part of the overall job will be extremely helpful.

The following section will discuss how you can participate in this team effort. The first step is to analyse your capabilities and determine where you can fit into the system approach.

1.7.1 What is my potential contribution to a search and rescue effort?

To answer that question, you must first examine your capabilities. Your place in a search and rescue effort will greatly depend on your level of training, on the capabilities of your boat and crew, and on the equipment you have on board. Let's now examine how these three elements can affect your place in a search and rescue effort.

1.7.2 Your level of training

Your level of training is very important, since it will determine what you can do to help in a search and rescue mission. The reason for this is obvious: emergency situations are usually not the best place to learn new skills. It is important to know how to perform the necessary tasks, since time is of the essence. In addition, lack of knowledge in an emergency situation can put someone at risk. If you become part of the emergency, you are not helping anybody. When someone (the On-Scene Co-ordinator or the Co-ordinator of the Rescue Co-ordination Centre, for example) gives a unit a specific task, it is essential for that unit to determine whether or not they have the level of knowledge required to carry out the task safely and efficiently. The following questions may help you to assess your ability to perform a task:

- Do I know exactly what is expected from me?
- Do I know how to do what is expected of me?
- Do I know how to deal with any conditions that I may encounter during this task (waves, wind, darkness, currents, injured persons, etc.)?

1.7.3 The capabilities of your boat and crew

These are other very important factors. You yourself may have the knowledge required for a task, but your boat may not be adequate for the task. For example, you may be an expert in cardio-pulmonary resuscitation (CPR). But if your boat does not have enough deck space to perform CPR properly (assuming that you are the only unit present), you cannot help. Alternatively, you may have a large, powerful vessel fully equipped for towing. Yet, you will be useless again if the water is not deep enough to allow you to reach a grounded vessel.

The same applies to your crew. You may be a very competent and experienced seaman or seawoman, but if your crew cannot follow you or support you, you may end up in trouble. Once again, search and rescue is a team effort. You cannot expect to do well on any search and rescue mission if you act alone as a unit or alone as an individual. Always remember that many tasks must be performed during a search and rescue mission. If, in a SAR crew, only one person is capable of performing all the tasks, that person will certainly get overwhelmed at some point. If you are an expert in CPR, to use the same example, and also happen to be the only team member capable of piloting your boat, you will have a problem if you happen to be called upon for a cardiac emergency. It is good practice to have some redundancy in the areas of expertise of every crewmember. In other words, at least two persons on your unit should be able to perform any important tasks. Examples of important tasks are piloting, performing basic first aid and CPR, reading charts, and using radios.

1.7.4 Equipment on board

The last factor determining your place in a search and rescue effort has to do with the equipment you have in your boat. If you do not have the proper equipment to perform a certain task, obviously, you should not try to take on that task. For example, if your vessel is not equipped with any kind of communication devices (radio, cellular phone, etc.) you will certainly not be able to be efficiently involved as an on-scene co-ordinator. In other situations, equipment may be present but inadequate.

These three points are emphasised for a very good reason. Many people think that any help is better than no help at all. In situations where one person is the only help available, this can certainly be true. However, in situations where other units could be available, things can be different.

Imagine, for example, that you are asked to provide assistance to a vessel that is sinking. You accept the task even though you do not have the equipment needed to pump the water out of the sinking boat. By the time you realise that you cannot help, the boat that you are trying to assist may be in greater distress. As a result, another better suited unit will be tasked, but the precious time that was wasted may be enough to change the initial “sinking vessel” situation to a “persons in the water” situation. In this example, any help is definitely not good enough. If you are not the only unit available, always assess your chances of success before accepting a task. Accepting a task for which you have little chance of success wastes precious time. In critical incidents, that time can mean the difference between life and death.

1.8 WHO SHOULD BE CALLED FIRST?

If you witness a marine incident, who should you call first? The answer to that question depends on the location. There are many numbers that can be dialled. Any number may get help, but the right number will ensure a faster response.

1.8.1 Waters under federal responsibility

Waters under federal responsibility include the east and west coasts, the St. Lawrence River, all the Great Lakes and the Arctic region. If you want to report a marine incident in these waters, the best way is to directly call the nearest Rescue Co-ordination Centre (RCC) or Maritime Rescue Sub-Centre (MRSC). Every rescue centre has a toll-free number and can be reached easily with regular or cellular phone. In addition, MCTS can be easily reached by cellular phone by dialling *16.

RCC Victoria, British Columbia
Toll-free number: 1-800-567-5111
Cellular phone: *311

RCC Trenton, Ontario
Toll-free number: 1-800-267-7270

MRSC Québec City, Québec
Toll-free number: 1-800-463-4393

RCC Halifax, Nova Scotia
Toll-free number: 1-800-565-1582

MRSC St. John's, Newfoundland
Toll-free number: 1-800-563-2444

Note: For air incidents, all areas are covered by RCCs. For maritime incidents, only the areas listed above are covered.

To report a marine emergency situation in waters under federal responsibility, 9-1-1 should be avoided whenever possible because it only adds a further link to the chain of communication. Some 9-1-1 services have an agreement with rescue centres. In the best scenario, your call will be transferred immediately to the appropriate rescue centre. In other situations, the rescue centre might become involved quite a bit later. For similar reasons, other emergency numbers should be avoided (e.g., police and fire departments).

Even if you know the phone number of Coast Guard or the Coast Guard Auxiliary units in your areas, you should call the rescue centre first. It is not a good idea to report an emergency by calling the unit directly. The reasons for this are numerous:

- The rescue centre has more resources to organise the rescue operation. In huge operations, the rescue centre can call all the relevant units quickly.
- All conversations with the rescue centre are recorded. This is especially important in situations where the vessel in distress is signalling its own misfortune. If the communication is weak or garbled, the tape can be used to ensure that all critical information is well understood.
- If you call a unit to report a marine emergency situation, that unit will have to relay the information to the rescue centre anyway. Another link is added to the process, and no time is saved.

Coast Guard Radio Stations (CGRS) are yet another way to report a marine incident. If for some reason you do not have access to a phone, you can use your marine VHF radio to report the incident. To do so, just call “Coast Guard Radio” on channel 16. This is not as direct as calling the rescue centre, but it may provide an additional advantage if you are already at sea. Many boaters monitor channel 16. Your broadcast of the details of the distress situation on this channel will be heard by many. If a nearby unit can assist, it will immediately set course for the distressed vessel. In this case, an additional link is added, but the overall effect is positive.

1.8.2 Provincial responsibilities

In other areas such as inland lakes and rivers outside federal waters, rescue services are structured differently and are normally provided by either local fire or police department, or by provincial government. In the case of a marine incident, it is paramount to know who holds the responsibility for search and rescue in those areas and who will provide the service, if available. Note that there are more and more volunteer groups and associations operating search and rescue units.

The means for alerting vary according to what is available and commonly used in the area. Keep in mind that there are no RCCs or Coast Guard Radio to answer your calls and, many boaters will not have marine VHF radios, but may carry a CB radio. In case of doubt, 9-1-1 may be tried first. If 911 does not work, you may need to call your local fire or police departments directly.

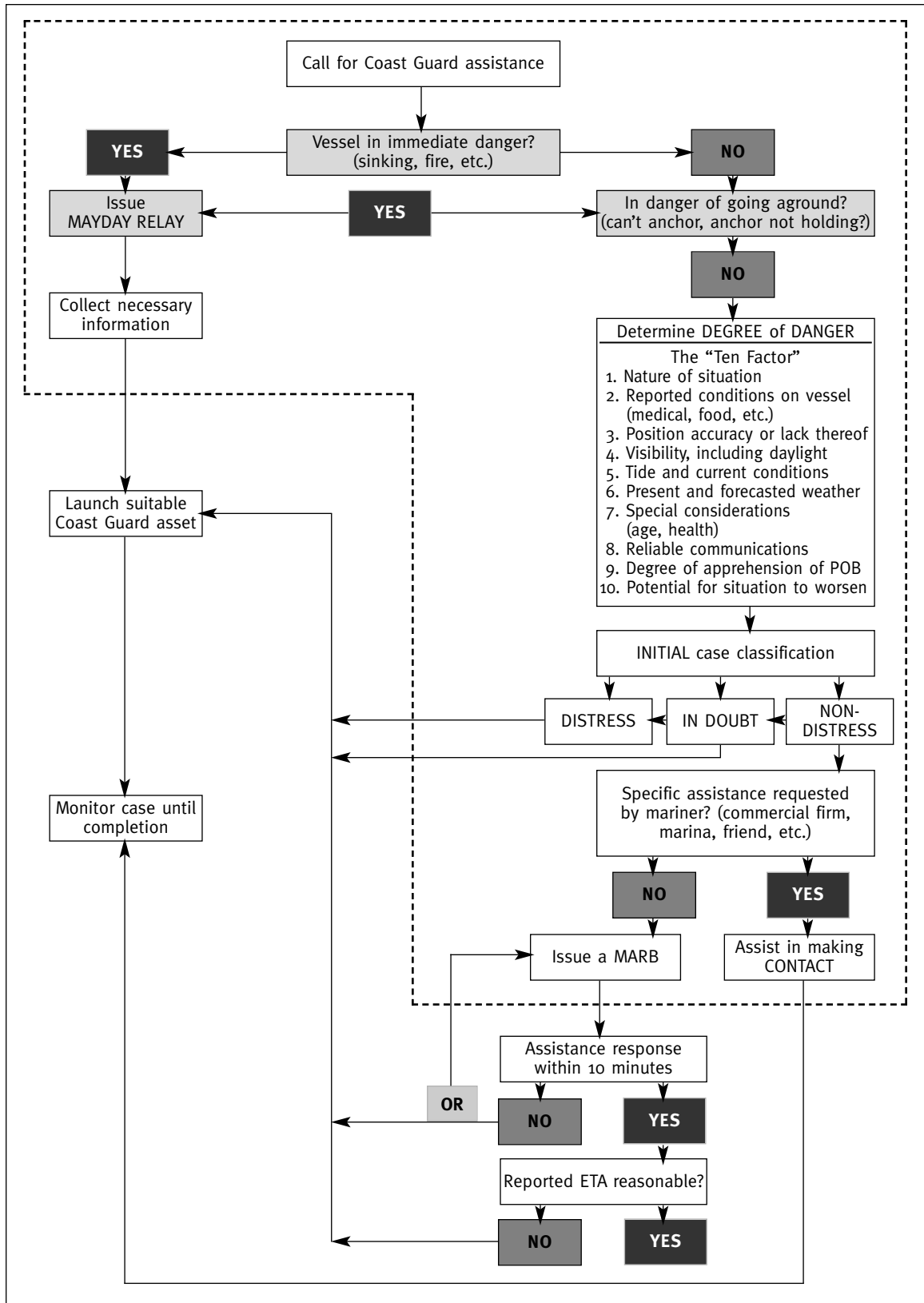

Figure 1.5: Activating the maritime SAR system

CHAPTER 2 – HUMAN FACTORS

2.1	Why spend time discussing human factors?	2-3
2.2	Profile of a good SAR team	2-3
2.2.1	Communication	2-3
2.2.2	Briefings	2-4
2.2.2.1	Make the time	2-5
2.2.2.2	Be open and friendly	2-5
2.2.2.3	Anyone can conduct the briefing	2-5
2.2.2.4	A briefing must be interactive	2-5
2.2.2.5	Define responsibilities	2-5
2.2.2.6	Use closed-circuit communications	2-5
2.2.2.7	Keep focused	2-5
2.2.2.8	Ensure that no question remains unanswered	2-5
2.2.3	Debriefings	2-6
2.2.4	Challenge and response	2-6
2.2.4.1	Steps in a challenge	2-6
2.2.4.2	Taking advantage of challenges	2-7
2.2.4.3	Obstacles to challenges	2-7
2.2.5	Short term strategies	2-7
2.2.5.1	Identify the problem	2-8
2.2.5.2	Developing the plans	2-8
2.2.5.3	Check the plans	2-8
2.2.5.4	Summary briefing	2-8
2.2.5.5	Monitor	2-8
2.2.6	Authority and assertiveness	2-8
2.2.7	Management styles	2-10
2.2.7.1	Tiger style – high on performance but low on people	2-11
2.2.7.2	Penguin style – low on performance but high on people	2-12
2.2.7.3	Snail style – low on both performance and people	2-12
2.2.7.4	Sheep style – average concerns for both people and performance	2-12
2.2.7.5	Dolphin style – high on people, high on performance	2-13
2.2.7.6	Management style analysis	2-13
2.2.8	Workload	2-13
2.2.8.1	Decrease the number of tasks to be accomplished	2-14
2.2.8.2	Decrease the weight of individual tasks	2-14
2.2.8.3	Increase the time available for accomplishing the tasks	2-16

2.2.9	State of a team	2-I6
2.2.9.1	Optimum state (+1)	2-I6
2.2.9.2	Concerned state (+2)	2-I6
2.2.9.3	Alarmed state (+3)	2-I6
2.2.9.4	Bored state (-1)	2-I6
2.2.9.5	Inattentive state (-2)	2-I6
2.2.9.6	Inattentive at a critical phase (-3)	2-I7
2.2.10	Judgement and decision-making strategies	2-I7
2.2.10.1	Vigilance	2-I7
2.2.10.2	Problem discovery	2-I7
2.2.10.3	Problem diagnosis	2-I7
2.2.10.4	Alternative generation	2-I7
2.2.10.5	Risk analysis	2-I8
2.2.10.6	External influences	2-I8
2.2.10.7	Decision	2-I8
2.2.10.8	Action	2-I9
2.2.10.9	Monitoring	2-I9
2.3	Image and attitude	2-19
2.3.1	Heroism: a dangerous attitude	2-I9
2.3.2	Professionalism	2-20
2.3.2.1	The ingredients of professionalism	2-20
2.3.2.2	Knowledge and skills	2-20
2.3.2.3	Acting in a professional manner	2-21
2.3.2.4	Image	2-22
2.3.2.5	Crew Attitude	2-22
2.3.2.6	Knowledge and skills	2-23
2.3.2.7	Operating a boat in a professional and courteous manner	2-23
2.4	Critical-incident stress management	2-24
2.4.1	Critical-incident stress	2-24
2.4.2	Reacting according to experience	2-25
2.4.3	Countering the effects of stress	2-25

2 HUMAN FACTORS

The previous chapter emphasized that maritime search and rescue has a lot to do with teamwork. Given the importance of teamwork, a good search and rescue reference manual must deal with the vast subject of human factors. Thus, before any explanation about technical material, equipment, and the other interesting hands-on items that are important, this chapter will look at people: people in their living and working environment, the human relationship with equipment, procedures and the environment. It will also look at people's relationships with other people.

2.1 WHY SPEND TIME DISCUSSING HUMAN FACTORS?

Since search and rescue units often have to perform their duties in adverse conditions, mishaps or errors are bound to happen. Sometimes these errors have disastrous consequences. Many professional SAR crews have been lost during search and rescue missions. A look at the statistics shows clearly that technical errors are involved in less than 25% of all incidents. Thus, the problem does not seem to be whether or not the crews can do their job well. Rather, it has been shown that the leading problem is "human error." A "human error" is committed when either the wrong action or a bad decision is not discovered and is left uncorrected. Inaction and indecision can also become "human errors." To minimize the risk of human errors, understanding human factors is important. This section will give techniques that may help you to improve your teamwork and thus minimize the risk of human errors.

2.2 PROFILE OF A GOOD SAR TEAM

Many studies have revealed the individual qualities that are required for good teamwork. Individuals that are good at teamwork:

- Communicate clearly and precisely
- Accept challenges and know how to respond to them
- Use short term strategies as needed
- Have the right balance between authority and assertiveness
- Manage to find a balance between performance- and people-oriented styles when they are acting as team leaders
- Know how to control their workload
- Can maintain an adequate level of alertness
- Have sound judgement and, usually, good decision-making skills

2.2.1 Communication

Communication is a key factor in teamwork, simply because misunderstandings are so common. Often, a clear message will be distorted in some way upon reception. This phenomenon is normal, since none of the human senses is perfect.

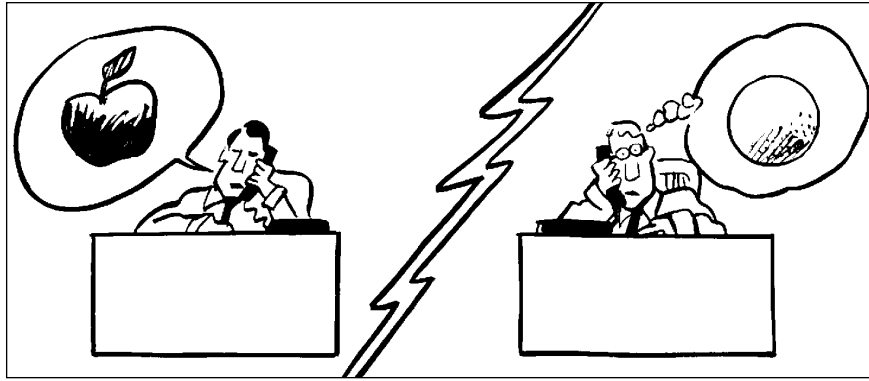

Figure 2.1: *Sometimes, what is heard is not what was said!*

The quality of communications in a team is determined by several factors. First, communications have to remain open and interactive. “Open” means that the the concerns, comments and opinions of other team members are welcome. “Interactive” means that every member of the team is participating in the communication process.

Once open and interactive communication has been established, the next step in avoiding misinterpretations is closed-loop communications. Closed-loop communications should be used every time important information is exchanged. In closed-loop communication, the sender transmits the message, and the recipient acknowledges by repeating all the important information. Then, the sender confirms the accuracy of what the recipient understood. If the recipient understood correctly, the communication ends here. If not, the sender will repeat the original message. The recipient will confirm once again and the sender will validate once more. The following figure illustrates this technique.

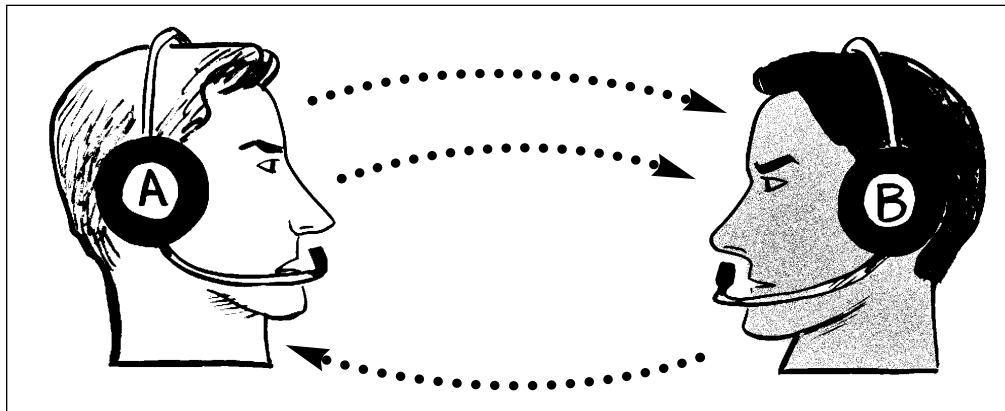

Figure 2.2: *An example of closed-loop communication*

2.2.2 Briefings

Briefings, when properly conducted, can also minimize the risks of confusion. Briefings should be used whenever you are planning something that will involve the active participation of another team member. When conducting a briefing, be certain that everyone understands his or her tasks. To conduct efficient briefings, the following rules should be remembered:

2.2.2.1 Make the time

For an efficient briefing, take enough time to avoid rushing any critical information. Every minute invested in such briefings will save significant time that would have been lost due to confusion.

2.2.2.2 Be open and friendly

The members of a team are not robots. They do not await orders to dictate their behaviour. Let them contribute to the briefing by adding their personal touch to the plan. A briefing must be a pleasant activity. It should make clear to everybody that their talents will be used to resolve a situation. It is essential that everyone remain friendly throughout the briefing.

2.2.2.3 Anyone can conduct the briefing

A briefing does not always have to be conducted by the team leader or coxswain. Usually, the person having the most information should conduct the briefing. It is good practice to let every member of the team conduct briefings.

2.2.2.4 A briefing must be interactive

Under no circumstances should a briefing become a “one-man show.” Contributions from other team member should be welcome. Proceeding this way makes finding a solution a team effort. Chances of omitting important information are reduced considerably in this way.

2.2.2.5 Define responsibilities

After a good briefing, every team member should know what his or her responsibilities are.

2.2.2.6 Use closed-circuit communications

During a briefing, important information is exchanged. It would thus be advisable to use closed-circuit communications to avoid misunderstandings.

2.2.2.7 Keep focused

Resist the temptation to start discussions about matters that are unrelated to the initial problem. Keep focused on the problem you have to resolve. Try not to lose that focus by dwelling on insignificant details. Define your general plan. Deal with details as needed.

2.2.2.8 Ensure that no question remains unanswered

It might be a good idea to take some time to allow everybody to ask last-minute questions before ending the briefing.

2.2.3 Debriefings

Once a mission is completed, it might be a good idea to conduct a debriefing. Debriefings should be conducted as soon as possible after the mission. If the debriefing cannot be conducted soon enough, every member of the team should jot down a few notes about things they want to discuss. Here are some important points to remember for debriefings:

- This time, the coxswain or team leader should conduct the debriefing;
- The coxswain/team leader should indicate his or her mistakes first to set the example;

- Everybody should remain objective;
- Evaluate both positive and negative aspects of your performance;
- Try to learn from your mistakes;
- Avoid finger-pointing. Talk about team performance;
- Keep the debriefing interesting;
- Prepare plans for the next time you encounter a situation like the one you just dealt with. Ask yourself how you would react if you had to perform the same tasks tomorrow;
- Keep a cordial, informal atmosphere.

2.2.4 Challenge and response

People who have a tendency to challenge are often considered a problem in a team. This is unfortunate, since challenges can be essential to improving teamwork. Of course, not all challenges are useful, but some are. As a matter of fact, statistics show that lack of challenges is involved in more than 30% of marine incidents.

Not all challenges are good for teamwork. Challenging authority or decisions is certainly not always helpful. On the other hand, challenging concepts can minimize the risk of error and thus, the risk of getting into trouble.

2.2.4.1 Steps in a challenge

Challenging a concept usually involves the following steps:

- A concept is stated and limits are set;
- The situation progresses and moves outside the limits that were set;
- A challenge is issued;
- A proper response is formulated.

The following example illustrates these steps:

Coxswain: “We will turn to port at the fourth red buoy.”

Crewmember: “Port at the fourth buoy...”

Coxswain: “That’s right.”

A little later...

Coxswain: “Ok. Let’s turn to port now.”

Crewmember: “But... don’t we have another buoy to pass before we turn?!?”
“Oops! You’re right! Let’s turn after we pass the next buoy.”

Here, the concept was the need to turn to port, and the limit was set at the fourth red buoy. The situation moved outside the limits when the coxswain asked to turn before the fourth buoy. A challenge was issued and a proper response was given. As you can see, in this case, the challenge prevented a potentially dangerous situation.

Note that concepts can arise from many different sources. All the on-board instruments are sources of concepts. Sometimes, what these instruments indicate is in contradiction with what one believes to be true. If that happens to you, you should challenge either what you think or what the instruments are indicating. In such situations, it is important that you

find your own answers. For example, if your depth sounder indicates that you have 2 feet while your marine chart indicates that you should have at least 20 feet, you'd better find out the right answer.

2.2.4.2 Taking advantage of challenges

The following guidelines may help you to take advantage of challenges:

- Challenges should be allowed and welcomed in a team;
- Always challenge when you believe that you are moving outside the limits of the initial concept;
- Be diplomatic when you formulate a challenge.

The answer given to a challenge is as important as the challenge itself.

When you are responding to a challenge, consider the following guidelines:

- Always check the validity of the challenge. Use a third source of information if necessary.
- Be cautious, especially in emergency situations. The challenge might be valid!
- Be diplomatic when you formulate a response to a challenge. Never laugh at someone who has issued an invalid challenge. If you do so, the person may no longer challenge.

2.2.4.3 Obstacles to challenges

If you want to encourage challenges, you need to be aware of some obstacles that may occur. These obstacles can involve either the challenger or the receiver.

Obstacles can occur if the challenger:

- is a quiet person;
- lacks confidence;
- is not assertive;
- puts the team leader on a pedestal;
- does not fully understand something;
- does not like responsibilities;
- is involved in interpersonal conflicts;
- has had bad experiences with inappropriate responses to previous challenges.

Obstacles can occur if the receiver:

- feels that his or her authority is threatened by challenges;
- lacks confidence;
- responds emotionally;
- has poor communication skills;
- has poor management skills.

2.2.5 Short-term strategies

Short-term strategies are defined as plans that are developed to solve a particular problem. Short-term strategies should be used, when time permits, to solve any problem that is not covered by standard operating procedures. Developing good short-term strategies requires the following steps:

- Identify the problem;
- Develop plans to deal with the problem;
- Check plans with the rest of the team members in an interactive briefing;
- Explain the mutually-agreed plan in a summary briefing;
- Ensure that the plan is followed;
- Modify and update the plan if conditions change.

Let's now define each step.**2.2.5.1 Identify the problem**

Before developing a plan, you need to know why a plan is needed. Exactly what is the problem you have to deal with? To effectively identify the problem, you need to use all available resources. Involve as many people as you can. In critical situations, you may try to make some time. This usually involves slowing down. For example, if you think you have deviated from a safe course, you may stop and take the time to figure out what your position is.

2.2.5.2 Developing the plans

Again, try to use all resources, and try to create time. Set your priorities and build your plan accordingly. Develop more than one plan. Once you have a few options, go to the next step.

It is essential to allow every member of a team to give their input when a plan is to be made. Each member of a team has his or her own experiences and ideas. The combined knowledge of all members of a team is thus far superior to the knowledge of individual members. By using this combined knowledge, you will probably have a very solid and very safe plan to deal with the situation at hand.

2.2.5.3 Check the plans

Try to choose the best plan. Ask for suggestions and compare all the plans. Consider everybody's input. Be sure that all issues are addressed and nothing is missing. Once you have chosen the best plan, choose some backup plans. This strategy will be useful if events do not progress as you planned.

2.2.5.4 Summary briefing

Get all members of your team involved in carrying out the plan. Obtain each member's commitment. Set monitoring guidelines for your team. Make sure that everyone knows what he or she has to do.

2.2.5.5 Monitor

As you carry out the plan, problems may arise. Try to solve each individual problem as it comes up. Respond to any challenge as it is voiced. Make sure that the plan you chose is working within the guidelines (or limits) that you set.

2.2.6 Authority and assertiveness

Authority is certainly an important component in leading a team. However, finding the right dose of this ingredient is not easy. Using too much authority can be as detrimental to

a team as using too little. Assertiveness is also a very important quality, but again, finding the right balance is tricky. This section offers some tools that might help to find the right level of authority and assertiveness.

Let's start by defining the two kinds of authority: formal and personal authority. Formal authority is the authority that goes with a particular job or status. For example, a captain or coxswain is given formal authority. These people are expected to make decisions, and they are usually paid to do so.

Personal authority is quite different. Personal authority has to do with all the things that make others listen to one's suggestions. Usually, wisdom, professionalism, integrity, honesty and diplomacy form the cornerstone of personal authority. Someone with strong personal authority does not need formal authority to command attention. Using formal authority to command attention should be avoided.

Assertiveness is also an important attribute. Someone who is assertive is able to voice his or her concerns. But once again, too much or too little assertiveness can be bad. Combining different levels of assertiveness and authority results in different situations. The following examples illustrate various combinations:

Situation 1: Coxswain with strong authority and crewmembers with weak assertiveness

In this situation, the strong authority of the coxswain will intimidate the crewmembers. As a result, a crewmember will usually remain silent. All decisions and initiatives come from the coxswain. This is truly a one-person team. The following conversation illustrates this situation:

Coxswain: "Let's go this way and take a shortcut ..."

Crewmember: "But..." – to express some concern regarding the shallow depth in this area.

Coxswain: "I said we are going this way. What's your problem?"

Crewmember: "Nothing... Sorry."

Situation 2: Coxswain with weak authority and crewmembers with strong assertiveness

This is probably the least dangerous situation, since the strong assertiveness of the crewmembers compensates for the coxswain's lack of authority. The problem is that most decisions are made by crewmembers. The following conversation illustrates this combination:

Coxswain: "You are leaving the channel if you go this way."

Crewmember: "It doesn't matter... Water is deep enough."

Coxswain: "But... I would prefer if we could remain in the channel..."

Crewmember: "I said it's deep enough. It's not the first time I have been this way."

Coxswain: "Ok, ok... If you are so sure..."

Situation 3: Coxswain with strong authority and crewmembers with strong assertiveness

This situation can cause serious conflicts among team members. The coxswain and crewmembers will argue constantly. The coxswain may have to use his or her formal authority to end altercations. This situation can become very dangerous, since emergency

situations rarely leave time to argue. A situation like this one will be stressful for every member of the team. The following conversation illustrates the situation of excessive authority and excessive assertiveness:

Coxswain: “You are leaving the channel if you go this way.”

Crewmember: “It doesn’t matter... Water is deep enough.”

Coxswain: “I don’t want you to leave the channel – is that clear?”

Crewmember: “Read my lips: IT IS DEEP ENOUGH FOR US TO GO THERE.”

Coxswain: “I am in command here, so you will do as I say.”

Situation 4: Coxswain with weak authority and crewmembers with weak assertiveness

This is the most dangerous situation, because nobody will take the necessary decisions or actions. The serious lack of challenges on this kind of team will adversely affect the quality of decisions they make. The following conversation illustrates this problem:

Coxswain: “I’m not sure, but I think we just left the channel...”

Crewmember: “Should I slow down?”

Coxswain: “I don’t know... Wait... I can’t find our position...”

Crewmember: “You got it?”

Coxswain: “Not yet... Let’s wait a bit... We should see something that will help us.”

Crewmember: “Ok...”

A little later: **CRUNCH! The boat is damaged on a submerged rock.**

As you can see, none of these extreme situations are ideal. As a member of an SAR team, you must remain vigilant to prevent the development of such extreme situations. Now that you are able to recognize such dangerous extremes, let’s look at ways to prevent their occurrence.

Rule number one: if you want someone to become assertive, you need to create the appropriate working environment. To do so, it may be necessary to lower the level of authority on the team. The reverse situation is similar. If you want someone to be a little less assertive, you may want to increase authority. Once again, you should try to increase personal authority rather than formal authority.

2.2.7 Management styles

Management styles of a team leader or coxswain can have a profound effect on the behaviour, performance and well-being of a team. There are many ways to analyze management styles. The following approach is based on two dimensions: performance and people. Management styles can be high or low on both performance and people. Each combination produces a different effect on a team.

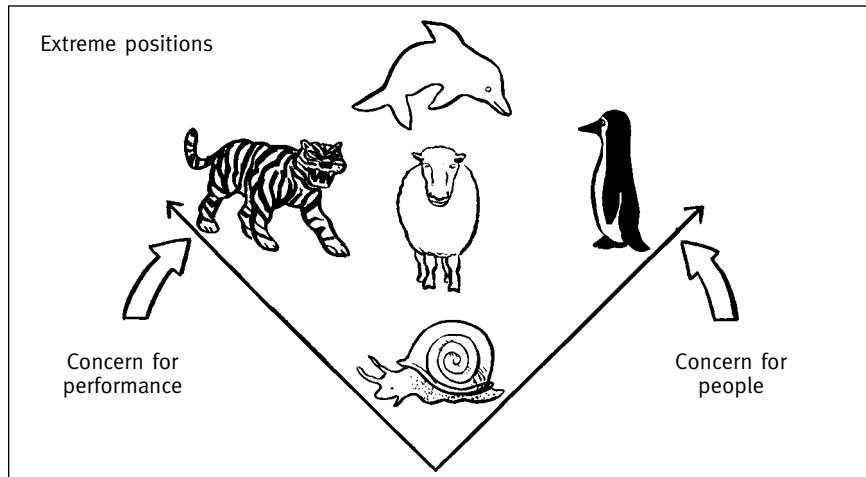

Figure 2.3:
The five different
management
styles

2.2.7.1 Tiger style – high on performance but low on people

Characteristics

- Believes in performance
- Often has too much authority
- Has a high opinion of himself or herself
- Does not care about what others may think
- Does not care about teamwork
- Great leader in crisis
- Takes full responsibility for his or her decisions
- Is loyal to the team
- Does not like challenges
- May have a tendency to do or to control everything
- Does not delegate easily

Effects on the team

- Silent team, low level of communication
- Low assertiveness of team members
- No challenges
- Performance may decline
- Team morale may get low
- Team members will not take many initiatives

2.2.7.2 Penguin style – low on performance but high on people

<i>Characteristics</i>	<i>Effects on the team</i>
<ul style="list-style-type: none"> • Believes that people are more important than performance. If people are well treated, they will necessarily do a good job • is a good listener • Likes to chat with everybody; has a tendency to accept lower professional standards so that everybody can do well • Talks a lot • Forgives easily, probably to avoid conflicts • Is always positive, even when results are unsatisfactory. Some good learning opportunities are lost because of this lack of objectivity 	<ul style="list-style-type: none"> • Friendly and calm working atmosphere • General lowering of professional standards • False feeling of adequacy on the team • Team members that are high on performance might get annoyed • Little training is done within the team • Leader does not command respect because of inability to provide objective and constructive feedback

2.2.7.3 Snail style – low on both performance and people

<i>Characteristics</i>	<i>Effects on the team</i>
<ul style="list-style-type: none"> • Serious lack of motivation • Is not really interested in his or her job • Has a tendency to do the basic minimum • Avoids conflicts • Has a low opinion of his or her own capabilities and of those of the team • Has low professional standards, both personally and for the team • Poor communicator • Weak authority • Does not use short-term strategies • Can often hide personal ineptitude by avoiding risks 	<ul style="list-style-type: none"> • All effects are negative • Worst management style • Low team morale • Professional standards can get dangerously low • Very little training is done

2.2.7.4 Sheep style – average concerns for both people and performance

<i>Characteristics</i>	<i>Effects on the team</i>
<ul style="list-style-type: none"> • Adapts quite well to surroundings • May compromise performance or team morale to achieve personal goals • Concerned by performance, but not enough • Communication is good but not excellent • Generally accepts challenges • Occasionally uses short-term strategies 	<ul style="list-style-type: none"> • Promising management style • Everyone feels that something is missing • Team morale is good, but could be better • Team performances are good but not excellent • Average training

2.2.7.5 Dolphin style – high on people, high on performance

<i>Characteristics</i>	<i>Effects on the team</i>
<ul style="list-style-type: none"> • Combines the best of the penguin and the tiger • Is capable of adjusting personal style to any situation • Good communications and briefings • Accepts challenges easily • Almost always uses good short-term strategies • No problem delegating • Knows strengths and weaknesses of team members • Believes that it is always possible to do better 	<ul style="list-style-type: none"> • Best management style • Training is a priority • Excellent team morale • Team is confident • All members of the team have good self-esteem • Professional standards are very high • Team members are motivated

2.2.7.6 Management style analysis

It should be clear that the ideal management style is the dolphin, but other styles do have some advantages. Each leader must be able to adapt his or her style to the situation at hand. In emergency situations, a tiger may be ideal for creating order out of chaos. On the other hand, in the presence of inexperienced people, it may be good to be more of a penguin at the beginning. In periods of low activity, a sheep may even be adequate.

If you feel that your team leader or coxswain is not an ideal manager, you may want to help him or her to change toward a better style. To do so, use arguments that your leader will value. For example, if your leader is a tiger, you may try to persuade him or her that performance will increase with less authority. In the case of a penguin, emphasize that you would feel better if the performances on the team were improved. A sheep will probably understand arguments about both performance and people. The snail is the most difficult style to change, because no argument may be convincing enough. Sometimes people need a strong jolt to confront them with their need to change.

2.2.8 Workload

To be efficient, you need to be able to control your workload. If you get overloaded, you will probably feel under stress, and this will adversely affect your performance. On the other hand, a very low workload will usually draw you into boredom and lack of motivation, which can also translate into a lower performance level. Your workload is your own responsibility. This section offers tools that may help you to manage your workload.

Let's first examine the consequences of an overload situation:

- duplication of effort (many people working on the same thing without knowing it);
- increase in errors;
- increase in level of authority with increasing workload;
- tunnel vision: individuals will focus on important tasks and may miss important details;

- generalized bad mood and impatience;
- lowered attention to tasks;
- delegation decreases as workload increases;
- short term strategies are neglected;
- decrease in communications (no one has time to talk).

The concept of workload can be explained using a formula. This formula is certainly not very scientific, but it will be very helpful in understanding ideas related to workload.

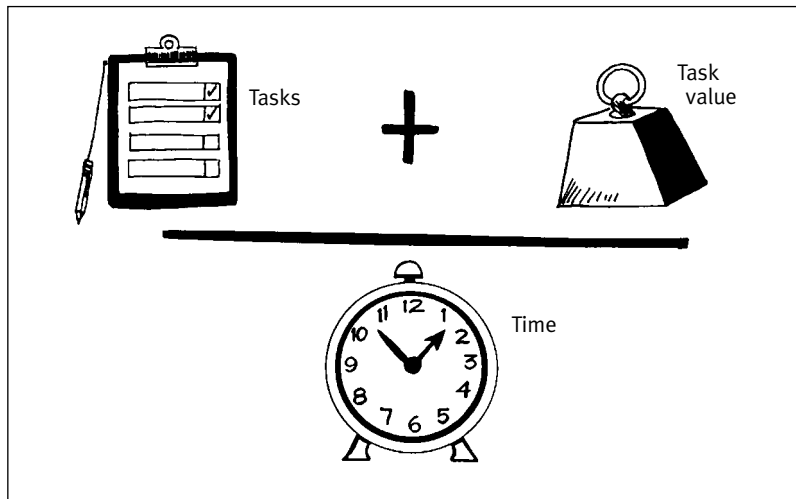

Figure 2.4: The workload formula

This figure illustrates how to compute a workload. Now, let's look at ways to lighten it. To lighten a given workload, you need to modify the individual components of the workload formula. There are three possibilities:

- Decrease the number of tasks to be accomplished
- Decrease the weight of individual tasks
- Increase the time available for accomplishing the tasks

2.2.8.1 Decrease the number of tasks to be accomplished

The best way to accomplish this goal is to delegate. Delegating not only decreases workload, it also trains people. Furthermore, when you delegate a task to a team member, you show that person that you trust his or her abilities.

There are many advantages to delegating, but you must be careful to avoid overloading when you delegate. Effective delegation includes the following steps:

- Decide what tasks you can delegate;
- Decide who is suited to performing those tasks;
- Plan your delegating strategy.

To decide what tasks you can delegate, you must know the skills of your team members. It is useless to delegate tasks that nobody can do! Ideally, the tasks you delegate should become opportunities for learning. Avoid delegating boring, repetitive tasks.

Once you have chosen the task you wish to delegate, choose the person to whom you will delegate that task. Consider skills, workload and motivation for the task.

It is now time to define your delegating strategy. It is usually a good idea to delegate some of the responsibilities that go with the task you are delegating. In this way, the team member will feel a connection with the end result, and his or her motivation will increase. When you delegate a task and the responsibilities that go with it, inform the rest of the team that you are no longer responsible for that particular task. If you do not do this, other team members will continue to come to you instead of to the other person. This situation can seriously undermine your efforts!

Another important aspect of delegation is support. Be prepared to give all the necessary support to the person who is now responsible for one of your tasks. It might take a little time at the beginning, but the time will be well invested once the person gets comfortable with the new task. Sometimes, you may need to refuse to help someone who does not have a lot of self-confidence. Providing too much help to these individuals will only prove that they cannot do anything by themselves.

Last important thing to remember: progress should be rewarded! When someone does a great job, reward him or her by giving more responsibilities. For example, if someone has found the best route to an emergency situation, you may offer the reward of steering the boat. This gesture shows that you appreciate the work of others. You also show that your confidence increases as the individual gets better at his or her job.

Many people have a tendency to find reasons to avoid delegating.

Most commonly evoked reasons are the following:

“If you want something done properly, do it yourself!”

“By the time I showed him, I could have done it twice...”

“I like doing this job and I’m good at it, so why should I delegate?”

“What if he makes mistakes?”

“I will lose control!”

Close examination reveals that these reasons do not justify an inability to delegate.

Here is why:

“If you want something to be done properly, do it yourself!”

True – it takes time to learn a new job... But you had to learn – remember?

“By the time I showed him, I could have done it twice...”

Again, speed with quality won’t come right away.

“I like doing this job, and I’m good at it, so why should I delegate?”

With practice, you will also get to like the job of delegating!

“What if he makes mistakes?”

Sometimes you need to let people make mistakes. Mistakes are usually not critical.

“I will lose control!”

You will actually increase your control because you will be able to get more done within the same amount of time.

2.2.8.2 Decrease the weight of individual tasks

Decreasing the weight of individual tasks is not an easy thing to do. The best way to achieve this goal involves training. With enough training, difficult tasks may become easier to perform. Checklists may be useful for tasks involving many steps.

2.2.8.3 Increase the time available for accomplishing the tasks

Increasing time is probably the most difficult thing to do. When you are on your boat, the best way to increase time is to slow down. Note that when you lower the number of tasks to do, you are indirectly increasing the time available for the remaining tasks.

2.2.9 State of a team

This is another factor that may affect the efficiency of a team. If your team gets bored or inattentive, performance will suffer markedly. Stress or panic will affect your team in the same way.

There are six states in which a team can find itself. Three of these occur during low workload and low stress situations, while the other three occur in high workload and high stress situations.

2.2.9.1 Optimum state (+1)

In this state, your workload and your stress level are appropriate. You do not have to fight to stay awake. You are motivated and efficient.

2.2.9.2 Concerned state (+2)

Both your workload and your stress levels are going up. You are starting to wonder if you will be able to do everything on time. Your worries begin to affect your productivity.

2.2.9.3 Alarmed state (+3)

You are overloaded. There is no doubt now: you will not be able to do everything on time. You are trying to figure out a way to get out of this situation. Maybe you should sacrifice a few tasks... It is hard to think about all this while you still have to work... You need all your strength to control your extreme stress level and to avoid panic.

2.2.9.4 Bored state (-1)

Workload is low... You have nothing to do. Things have been this way for a while now and you are bored. Your level of attention and your motivation are getting quite low. Fatigue begins to take its toll.

2.2.9.5 Inattentive state (-2)

This is the state where boredom and carelessness combine to produce an explosive mix. You are making mistakes and don't really feel the necessity to correct them. If you don't do something quickly, the next mistake could lead you into a critical situation. What is worse, you may not even notice that you are in trouble.

2.2.9.6 Inattentive at a critical phase (-3)

You are now in trouble and you don't even know it. Eventually, you will wake up and understand what is going on. If you are lucky enough, you may still have time to do something. If you are not, you will have to face the consequences of your lack of attention. Usually, when a team in this state wakes up, an initial phase of confusion occurs. After that, the team will shift from a -3 state directly to a +3 state.

Try to keep your team in a +1 state. In emergency situations, the state of your team might have a tendency to rise. Try to maintain it at +1 by using the techniques described above. Use short-term strategies, make some time, ensure good communications (closed-loop) and use briefings. These measures may help you to relieve pressure.

2.2.10 Judgement and decision-making strategies

Judgement is an aptitude that can be developed. To improve your judgement, you need a good decision-making process. You also need to know what factors can influence your judgement. This section will describe a decision-making process as well as some factors that may adversely affect your judgement.

This decision-making process involves 9 steps:

- Vigilance
- Problem discovery
- Problem diagnosis
- Alternative generation
- Risk analysis
- External influences
- Decision
- Action
- Monitoring

2.2.10.1 Vigilance

This is the first step in our process. Vigilance involves remaining aware that things may not go as planned. If you are vigilant, you know that anything can happen anytime and you plan accordingly. This way of thinking minimizes the risk of being caught unprepared.

2.2.10.2 Problem discovery

When a problem occurs, you must discover it quickly. If you do not discover problems quickly enough, you may never get the chance to use your judgement.

2.2.10.3 Problem diagnosis

Once you have discovered a problem, try to understand how and why it happened. Finding the cause of a problem will usually help you to find a way to solve it.

2.2.10.4 Alternative generation

Now is time to find a way to solve the problem. At this point, any idea is good. Try to find as many potential solutions as possible.

2.2.10.5 Risk analysis

In this step, you analyze the risks associated with each alternative. Once you have analyzed all the risks, you should be able to pick the best solution.

2.2.10.6 External influences

When you are ready to choose a solution, you are likely to be influenced by external factors. Very often, these influences or pressures will push you toward a solution that is not ideal. Common influences include:

- **economic factors** (e.g., it's too expensive)
- **responsibilities** (e.g., I promised... I have to...)
- **general attitude** (will be detailed later)
- **peer pressures** (e.g., everybody is doing it... I have to be like the others...)
- **physical status** (e.g., fatigue, illness...)
- **hidden pressures** (will be detailed later)

General attitude can seriously affect anyone's judgement. The following general attitudes are considered dangerous:

- **anti-authority** (e.g., Don't tell me what to do... I don't have to follow the rules...)
- **impulsiveness** (e.g., Do something... QUICK!)
- **invulnerability** (e.g., It won't happen to me.)
- **excess confidence** (e.g., I can do it!)
- **resignation** (e.g., What's the point... it won't change anything...)
- **narrow-mindedness** (e.g., I've been doing things this way for the past 3 years and I'm not about to change.)
- **lack of initiative** (e.g., It's not my job to do this.)
- **laziness** (e.g., That should be enough... Nobody will notice...)

Hidden pressures: hidden pressures are simply pressures that you are not aware of. These pressures usually involve your previous experiences, your fears (conscious or unconscious) and your beliefs. For example, your fear of death may become a hidden pressure if you are called upon to retrieve a body. Dealing with hidden pressure is not an easy thing. You have to try to identify hidden pressures that might affect you at any particular time. A good way to accomplish this is to ask yourself: "Why am I doing this?" For example, if you are driving at 150 km/h on the highway, your answer to the previous question might be that you don't want to be late. But why is that? Maybe it is because you have a reputation of never being late. In this case, your own reputation could be a hidden pressure. Knowing what pressures are affecting you is only the beginning. You still have to do something to minimize the effect of these pressures.

2.2.10.7 Decision

You have decided which solution is best and you are ready to act. Conduct a briefing at this point to let everyone know your plans and to assign tasks.

2.2.10.8 Action

At this point, you simply translate plans into actions.

2.2.10.9 Monitoring

You must monitor the effectiveness of the solution you chose as you are applying it. Doing so will ensure that any corrective measures are taken as needed.

2.3 IMAGE AND ATTITUDE

The image you project and the attitude you have when doing search and rescue can have a profound impact on the efficacy and safety of your unit. This section describes the importance of being professional, both in appearance and in action. Before getting into the heart of this topic, a warning about a very dangerous attitude: heroism.

2.3.1 Heroism: a dangerous attitude

First, what is a hero? A hero is usually defined as someone who has done something brave or good and is admired by a lot of people. To deserve such admiration, a hero must stand above the crowd. He or she must be brave enough to be willing to put the lives of others above his or her own. In the coordinated team effort of an SAR operation, a heroic attitude is of no help to anyone. Any individual craving admiration is likely to become a burden to the rest of the team. Anyone willing to risk his or her own life in an SAR mission should stay home. The last thing an SAR team needs is the risk of another victim on its hands.

The previous paragraph may sound a little odd. Heroism is, indeed, socially valued today. In fact, the feats of so-called heroes are the theme of many television shows, which portray ordinary people risking their lives to save another living being (human or animal). Their courage often results in a happy ending almost as ideal as the stereotyped “happily ever after” of children’s fairy tales. What these shows don’t say, however, is that for every successful hero, a dozen “ordinary people” risked their lives and lost them. The heroes shown on television were lucky.

Many rescuers have a genuine desire to help other people. Some want to become heroes. These two attitudes are often incompatible. Imagine, for example, that you are participating in a large search operation. Each unit has been assigned to a particular search area. If the members of one unit decide that they want to be the ones to find the missing person, they will probably want to search the area where they think they have the best chances. They may be tempted to leave their assigned search sector (or to search it quickly, inappropriately) to move to the area where they want to search. Imagine now that every unit does the same thing. Obviously, the probability of detection of the missing person would fall to near zero in such a case. Given the devastating effect that heroism can have on a team effort, it is crucial to resist the temptation to try to become an individual hero. If the missing person is rescued, the ultimate goal of saving a life will be achieved. That should be reward enough.

2.3.2 Professionalism

Professionalism is a very important subject in search and rescue. Clients of the SAR system often have to put their lives or their safety into the hands of complete strangers whose competence they have only a few minutes to evaluate. First impression is thus all there is. You, readers, are these strangers. You must understand how much the clients must trust you to leave you in charge of their destiny. If you want to earn the trust of people, you must act and look like a professional. Since your professionalism will be established upon first impression, you must also work on your image. This chapter will provide guidelines that should help you to develop a professional attitude.

Everyone should now understand the need to be professional. But what defines professionalism? What are the differences between someone acting in a non-professional manner and someone acting in a professional manner? Here are some answers to these questions.

2.3.2.1 The ingredients of professionalism

A brief look at the *BBC English Dictionary* yields the following definitions:

Professional (adj.) If something that someone does is professional, it is done well, and is of a very high standard.

Professionalism (n.) Professionalism is skill at doing a job.

These definitions make it easy to determine what is needed to achieve professionalism. To reach high standards, one needs to know everything that is pertinent to the job he or she is doing, as well as the skills that are necessary to translate the knowledge into action. Let's now examine the knowledge and skills that are required in search and rescue.

2.3.2.2 Knowledge and skills

The easiest way to define what knowledge is needed is to make a list of what (or whom) SAR personnel must work with.

People involved in SAR must work with:

- **Other people (crewmembers, RCC coordinators, CGRS personnel, etc.)**
- **Boats and boat-related equipment (their own and other boats):**
 - different types of propulsion packages
 - marine communication equipment
 - electronic navigation devices
 - on board safety equipment
- **Equipment:**
 - firefighting equipment
 - salvage equipment
 - first aid equipment
 - rescue equipment
 - personal safety equipment
- **Aids to navigation, charts, compasses, etc.**
- **People requiring assistance or in distress**

This list is certainly not complete. You probably can think of other elements that could be added to the list. Nonetheless, this list is more than enough to illustrate the point that SAR personnel must know how to work with the items on the lists. They must know how to:

- work in teams;
- use the available equipment;
- navigate;
- provide first aid;
- perform related tasks.

To identify skills, a list of the situations that may be encountered by SAR personnel is the most appropriate tool. These situations can be environmental (e.g., weather) or personal (e.g., fatigue).

Situations that may be encountered by SAR personnel:

- cold water
- rain
- fog
- winds
- currents
- shallow water
- deep water
- fire and explosions
- lack of sleep/fatigue
- hypothermia
- heavy seas/waves
- stress

Again, the list could be much longer. SAR personnel must be skilled enough to be able to work with the items on the first list under the situations on the second list. For example, SAR personnel should be skilled enough to be able to use their boat in fog, current or heavy seas. They should be skilled enough to be able to provide first aid under stress, when they are fatigued, and so on.

There are many ways to acquire knowledge. Reading this manual is one way to gain knowledge. Taking courses and training are other ways to gain knowledge. Learning from experienced people can also be a good way to gain knowledge.

Skills are usually acquired through practice. People who practice a lot will usually be more skilled than people who do not. This manual has explained many techniques. If you want to master these techniques, you must practice.

Reading will provide the knowledge, but practice will forge the skill. Do not expect to become an expert in anything if you do not practice.

2.3.2.3 Acting in a professional manner

The question about the difference between someone acting in a professional manner and someone acting in a non-professional manner was asked above. Let's try to answer that question now.

Skills and knowledge cannot be readily assessed by an observer. Evaluating level of knowledge and skill usually requires observing someone for a while. In other words, it is difficult

to assess these things on first impression. Clients of SAR systems thus have to rely on other clues. Image and attitude are those clues. No matter how knowledgeable, skilled and experienced a crew may be, if image and attitude are not professional, first impression will be bad.

2.3.2.4 Image

The image the SAR crew projects will have a profound impact on first impressions. Everything that is available for visual inspection should convey the image of professionalism. The image of the crew and SAR unit should thus be polished.

Crew image

Consider the following elements when polishing the crew image:

Clothing

- Any stains?
- Appropriate?
 - Wear clothes that are appropriate for the job (e.g., no swim suits)
 - Avoid references to alcohol, drugs or tobacco.
- Properly worn?
 - Avoid unbuttoned or untucked shirts.
 - Avoid rolled pants and sleeves.
- Personal image
- Do you look presentable?

Boat image

Consider the following elements when polishing the boat image:

Condition of the boat

- Clean?
- In good working condition (undamaged)?
- Paint still looks good?

Equipment

- Properly placed and stowed?
- In good condition and reliable?

2.3.2.5 Crew Attitude

Attitude is also very important. The way the SAR crew behaves or responds will determine how they will be perceived just as much as image does.

- **Be polite:**
 - Treat the clients with respect even if you think they do not deserve it.
- **Be positive:**
 - Smile!
- **Stay calm**

- **Look confident**
- **Be careful with gestures:**
 - Adopt a straight posture
 - Look at the person when he or she talks to you
 - Avoid hiding behind sunglasses when talking to people
- **Treat the client as an equal:**
 - Wearing a uniform does not elevate you above other human beings

2.3.2.6 Knowledge and skills

We said earlier that knowledge and skills cannot usually be assessed on the first impression. This may not always be true. Remember that your knowledge will be revealed any time you answer people's questions, and your skills, any time you and your crew are put into action. If you fail to answer basic questions or to apply basic skills (docking for example) people will undoubtedly judge your knowledge or skills as inadequate. It is important to master basic knowledge and basic skills, since people can easily judge these. They can easily judge these since they all have a reference: they can compare your basic skills and knowledge with their own.

2.3.2.7 Operating a boat in a professional and courteous manner

The way a crew operates its unit can also be a very efficient way to measure their professionalism. Remember that SAR units are easy to spot on the water. When you navigate, you are usually observed by many boaters. If you navigate in a reckless manner, all your efforts at trying to be professional are wasted.

Navigating in a professional manner means:

- observing the regulations (colregs and any local regulations);
- avoiding passing too close to other vessels;
- manoeuvring in a way that will clearly show your intentions;
- avoiding riding the wake of other vessels;
- avoiding intentionally jumping waves;
- manoeuvring at a safe and reasonable speed;
- showing courtesy.

Courtesy

To earn the respect of other vessels, and to be welcome in marinas or harbours, it is essential to be courteous whenever possible. The non-written rules of basic water courtesy include:

- slowing down when passing close to other vessels;
- slowing down in the vicinity of marinas;
- manoeuvring at slow speed in marinas and near docks;
- avoiding excessive noise in marinas (especially at night);
- letting less manoeuvrable vessels proceed before you in narrow areas;
- avoiding using the best spots at docks.

2.4 CRITICAL-INCIDENT STRESS MANAGEMENT

SAR crew can sometimes be exposed to extremely difficult situations. Critical-incident stress disorder (CISD) can result from such exposure. All regions have a counseling service to provide support to all employees, such as SAR crews, who are exposed to critical incidents. In order to increase awareness of critical-incident stress, this section will deal more specifically with this subject.

2.4.1 Critical-incident stress

Critical-incident stress is the potential reaction of an employee involved in a critical incident. The various types of critical incidents are as follows:

- death or severe injury in the line of duty;
- suicide or sudden death of a co-worker;
- multiple-casualty incidents;
- incidents in which victims are severely injured;
- prolonged rescue or recovery operations, especially when children are involved or where the victim is known to rescue personnel;
- situations with intensive media coverage and scrutiny;
- situations of violence in the workplace.

The following situations, more specific to maritime SAR operations, are also part of the above list:

- recovery of bodies;
- witnessing a suicide from a bridge, a dock, a ferry;
- operating in full view of public and/or media;
- failing to succeed in a rescue attempt;
- failing at CPR in a case where the victim still had vital signs when recovered.

Other situations can be very stressful. For example:

- exposure for very long periods to the motion of a lifeboat in a violent storm;
- failing to assist in cases of damage or property loss;
- being unfairly criticized for response to an incident.

There are as many types of critical incidents as there are incidents. However, coxswains are responsible for their crew's safety and for preventing injuries, including psychological injuries. They must monitor their own reactions to stress and watch the reactions of their crew, bearing in mind that these are only normal reactions by normal people in abnormal situations. In critical incidents where the potential psychological injury is obvious, remember that some normal emotional reactions can be expected.

2.4.2 Reacting according to experience

Often, individuals will react according to their respective experience or age, especially younger crewmembers who have a preconceived picture of SAR operations (the tendency to see SAR as saving life and forgetting that loss of life can also occur in any SAR operation). One way of avoiding stress is a short debriefing, just to check, inform and reassure. A critical-incident stress debriefing can be provided upon request. IRB and Coast Guard Auxiliary members should check their local procedures. Other crews can contact RCCs/MRSCs for more information.

An affirmative answer to any of the following questions after a critical incident may indicate that the job-related stress has reached a danger point and a debriefing is needed:

- Do I have trouble putting the incident out of my mind?
- Do I experience persistent nervous, jittery feelings?
- Am I forgetful, short-tempered or fearful?
- Do I have nightmares, sleep disturbances, or a preoccupation with death?
- Am I withdrawn from friends or family and less interested in sex or other activities that I used to find enjoyable?
- Do I find myself drinking too much or depending on drugs to calm my nerves or get me through the day?
- Am I simply feeling out of sorts?

2.4.3 Countering the effects of stress

Many things can be done on the job to counter the effects of stress:

- Plan for appropriate rest breaks, when possible (this applies equally to the coxswain: if the coxswain does not take a break, it is hard to order the crew to take a break). A rule of thumb is one 15-minute break for every hour under intense stress;
- Rotate crew assignments, if possible, to avoid boredom due to repetition;
- Keep everyone informed and updated frequently;
- Provide adequate and suitable food (avoid, for example, serving anything raw or containing bones after incidents involving mutilated bodies or serving burnt food after incidents involving fires at sea);
- Avoid excessive coffee or sugar, since both tend to increase stress reactions in the body;
- If the crew is large enough, do not assign someone to recover the bodies of the persons he or she was previously assigned to search for;
- Cover bodies.

Refusing to recognize a stressful situation may have a serious impact on you and your colleagues. For example, a few years ago, personnel from different services worked on a crash site in Chicago where there were no survivors. No psychological support was provided to them. A year later, only 71 of the 351 individuals involved remained in their jobs. It is cheaper to support the individual than train a new team.

To conclude, the coxswain must create a climate of open discussion where feelings and reactions can be expressed. It is not a weakness to request help from your Regional Counseling Service; it is a weakness to deny the problem exists.

CHAPTER 3 – PERSONAL SAFETY

3.1	General	3-3
3.2	Protection in cold water	3-3
3.2.1	Wearing gear that fits	3-3
3.2.2	Cleaning and maintaining your safety gear	3-3
3.2.3	Picking the proper gear for the job	3-3
3.2.3.1	Flotation	3-4
3.2.3.2	Warmth	3-4
3.2.3.3	Protection	3-6
3.2.3.4	Ease of detection	3-6
3.2.3.5	Mobility	3-6
3.3	Personal safety equipment	3-7
3.3.1	General	3-7
3.3.2	Buoyant devices	3-7
3.3.2.1	General	3-7
3.3.2.2	Standard life jackets	3-8
3.3.2.3	Small vessel life jackets	3-9
3.3.2.4	Personal Flotation Devices (PFDs)	3-10
3.3.2.5	Anti-exposure work suits	3-10
3.3.2.6	Testing the floating capability of PFDs and flotation suits	3-11
3.3.3	Abandonment immersion suit	3-12
3.3.4	Dry suits	3-12
3.3.4.1	General	3-12
3.3.4.2	Dry suit maintenance	3-13
3.3.4.3	Dry suit storage	3-13
3.3.4.4	Repairs	3-14
3.3.4.5	Thermal underwear	3-14

3.3.5	Equipment vest	3-I4
3.3.5.1	Strobe light	3-I4
3.3.5.2	Personal distress flares	3-I5
3.3.5.3	Whistle	3-I6
3.3.5.4	Heliograph	3-I6
3.3.5.5	Dye marker	3-I6
3.3.5.6	Flashlight	3-I6
3.3.5.7	Portable VHF radio	3-I7
3.3.5.8	Knife	3-I7
3.3.6	Additional gear	3-I7
3.3.7	General cleaning routines for protective clothing	3-I7

3 PERSONAL SAFETY

3.1 GENERAL

SAR crews often have to perform their duties under extreme conditions (wind, waves, cold water, etc.). Personal safety is one of the most important issues to be aware of in order to avoid injuries. Many pieces of protective equipment are available for these conditions. This chapter will describe these pieces of equipment, their correct usage and maintenance.

Always remember, though, that safety equipment will not protect you against poor judgment. Leaders of SAR crews should always think about safety before deciding on measures to be taken.

3.2 PROTECTION IN COLD WATER

It is easy to forget how quickly the water can claim a life. It removes heat from our bodies twenty-five times faster than air at the same temperature. Yet, many victims do not even have the time to get cold. The shock of the icy waters forces them into hyperventilation. In 90% of cases, water will soon penetrate into the lungs and cause drowning. For the 10% that remain, spasms in the upper airways will prevent the entry of water into the lungs, causing “dry drowning.” These people will eventually die from suffocation.

Professionals who work on the water must be prepared for the unexpected. Wearing gear suited to the job provides a survival advantage. Remember that most drownings occur in good weather, when danger awareness is at its lowest.

To increase your chances of survival in cold water:

- Wear gear that fits;
- Clean and maintain your safety gear (keep it looking new);
- Pick the proper gear for the job.

3.2.1 Wearing gear that fits

Safety equipment that does not fit is of no use to you. There are countless stories of people struggling to survive and being hampered by exposure coveralls that are too big or a PFD floating above their head. Gear that does not fit is uncomfortable to work in and dangerous. If you are out in a boat often, get yourself one set of gear that fits and wear it.

3.2.2 Cleaning and maintaining your safety gear

Refer to section 3.3 for more information on cleaning and maintaining specific safety equipment.

3.2.3 Picking the proper gear for the job

Imagine having fallen overboard at night, and floating in frigid waters. What kind of safety gear would you wish for while you patiently tread water waiting for rescue? Answering that question will give you a good idea of what you may need to carry with you. Be warned

that it is easy to underestimate your needs when the sun is shining at your departure. Always remember that you may know the weather when you leave, but you can never know for sure what it will be like when you come back...

Safety-conscious crewmembers organize their gear before they leave and usually leave it in a kit or equipment vest (worn over top of a PFD). The safety equipment chosen must have five essential features:

- Flotation
- Protection
- Warmth
- Ease of detection
- Mobility

3.2.3.1 Flotation

How do rescue personnel survive the first few minutes of exposure, and protect their airways from the icy salt water? Flotation will keep the head up and out of the water and reduce the physical struggle to stay afloat. A PFD or a life jacket will be essential for those dangerous first minutes in the water.

3.2.3.2 Warmth

So you have made it past the first few minutes with your PFD or life jacket keeping you afloat. Now, if you are swimming in 1-15°C Canadian waters, hypothermia is your next concern. Without thermal protection, chances of survival after a long exposure to cold water are slim. An easy rule to remember is the rule of 50: “A 50-year-old man has a 50/50 chance of surviving for 50 minutes in 50°F (10°C) water” or “A 50-year-old man has a 50/50 chance of surviving a 50-yard (46 m) swim in 50°F (10°C) water.”

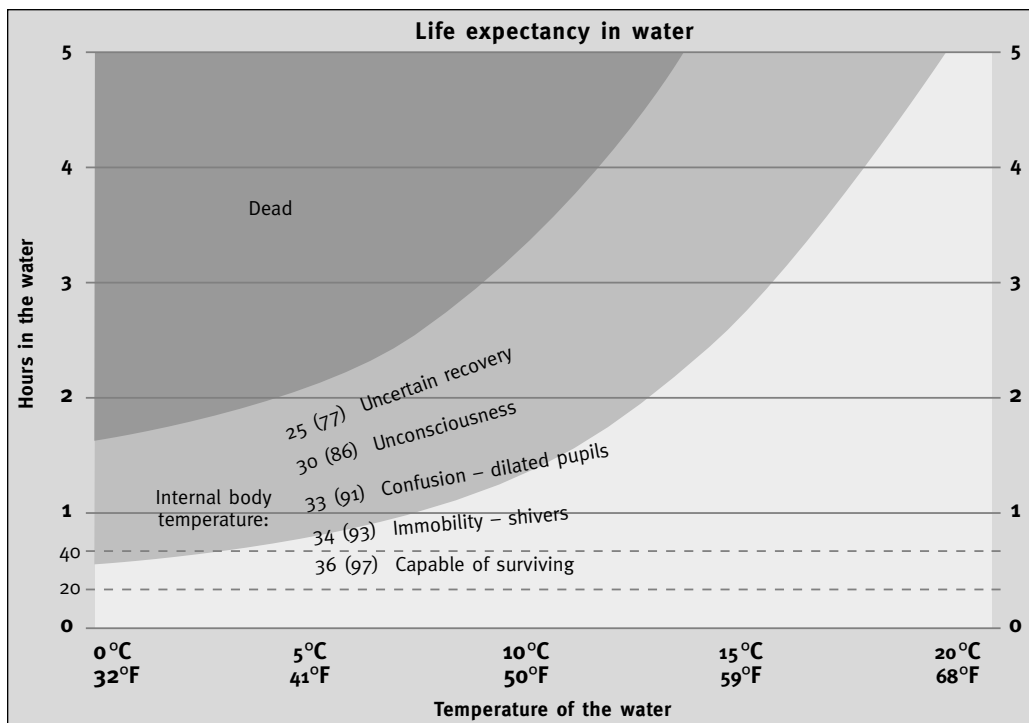

Figure 3.1: Chart of survival times as a function of water temperature (assuming no cold protection)

A multi-layer approach to thermal insulation will protect you against a chilly demise. Different materials distribute heat in different ways. Polypropylene uses heat energy to hold water away from the skin and insulates energy better than natural fibres. Wool gets wet but keeps the water suspended and keeps body heat protected. Wool stays relatively warm when wet. Cotton soaks up water like a sponge and holds it against the skin. As the water evaporates, heat energy is pulled away from your body (not a good choice).

The high heat loss areas of the body are the head, neck, torso and groin. When you are dressing for cold weather try to protect these areas first. A wool toque or balaclava on the head and a scarf or a polypropylene neck warmer can reduce heat loss by 25%.

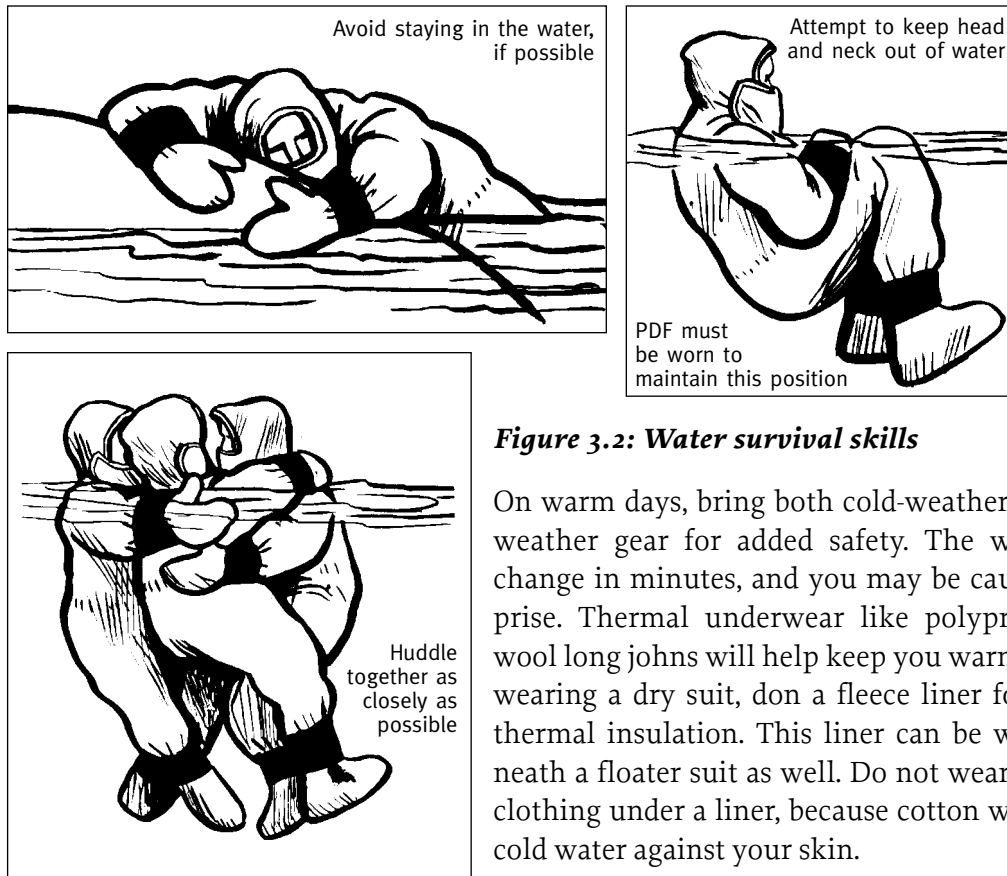

Figure 3.2: Water survival skills

On warm days, bring both cold-weather and warm-weather gear for added safety. The weather can change in minutes, and you may be caught by surprise. Thermal underwear like polypropylene or wool long johns will help keep you warm. If you are wearing a dry suit, don a fleece liner for excellent thermal insulation. This liner can be worn underneath a floater suit as well. Do not wear any cotton clothing under a liner, because cotton will keep the cold water against your skin.

There are a number of options for keeping yourself warm. The most common are anti-exposure work suits and lightweight SAR dry suits. These will be discussed in sections 3.3.2.5 and 3.3.4.

3.2.3.3 Protection

SAR vessels often operate in severe climatic conditions. With frequent heavy impacts due to waves, high wind chills, and excessive noise levels, a crewmember can find himself or herself in an extremely hostile environment, even when things are going well. In the event that something goes wrong, crewmembers may be at risk from head injuries and/or blunt trauma (internal lesions caused by a collision with an object that does not cut well). Protective gear is essential, given that your vessel may be engaged in SAR operations in these conditions. When there is the slightest risk that the vessel could be operating in extreme conditions, the crew must have helmets, eye protection and gloves.

Head protection is very important for survival on board any kind of Fast Rescue Craft (FRC). On board these craft, crewmembers will be exposed to strong and sometimes sudden accelerations, both horizontal (due to engines) and vertical (due to waves). Under these circumstances, the risk of head injury is high. It is imperative to wear helmets to minimize that risk. Helmets must be specially designed for use in the water: otherwise, they may fill with water and act like anchors. In addition, helmets must be lightweight to minimize stress on the neck during sudden speed change.

Eye protection is vital, particularly in extended operations. The eyes are the most vulnerable and sensitive areas of the body. They are easily damaged by glare, salt and wind. Some form of ultraviolet and wind/spray protection is necessary. The eye protection that you choose should protect you from all the elements but not interfere with vision by excessive fogging or restrictions on peripheral vision.

Gloves are a matter of personal preference. Some people prefer ski gloves, while others prefer a lightweight wetsuit glove. Gloves should allow unrestricted circulation in the fingers to ensure sufficient warmth.

Note: When it comes to gloves and eyewear, expensive is not necessarily better.

3.2.3.4 Ease of detection

There are active and passive ways to be detected. Passive “detectability” means that no movement is required for visibility. All your gear should be brightly coloured and covered with reflective tape. If you have an automatic strobe or water-activated EPIRB (Emergency Position-Indicating Radio Beacon), these will draw attention to you. Active signaling devices require you to use them to draw attention your way. All these devices should be inside the various pockets of the equipment vest.

3.2.3.5 Mobility

All personal gear should allow the wearer to move and work freely. In extreme conditions, some restriction of movement may be necessary to give the crew adequate protection from the elements. Make sure it all fits you.

3.3 PERSONAL SAFETY EQUIPMENT

3.3.1 General

Crews in custody of personal safety equipment are cautioned that the quality of maintenance and care of this equipment may be instrumental in the saving of lives, including their own. Personal safety equipment must be considered lifesaving equipment and treated as such.

Personal safety equipment on loan to an individual must be maintained in appropriate condition in accordance with the manufacturer's maintenance guidelines. Each person to whom the gear is issued is responsible for keeping the gear in proper condition. Faults or problems which are beyond the scope of maintenance by the individual are to be reported to the master or coxswain for appropriate follow-up (e.g., personal strobe-light batteries must be changed annually). It is the responsibility of the master or coxswain to ensure that every crewmember wears their personal safety equipment as needed. It is also the responsibility of every crewmember to wear their safety equipment when they feel they should do so.

3.3.2 Buoyant Devices

3.3.2.1 General

Buoyant devices should be thoroughly dry and stored in well-ventilated spaces. They should be kept clear of the bottoms of lockers or stowage boxes where moisture may accumulate, and they must be stowed away from excess heat. SAR crews should wear some kind of buoyant device at all times when on board. Buoyant devices will not protect those who do not wear them.

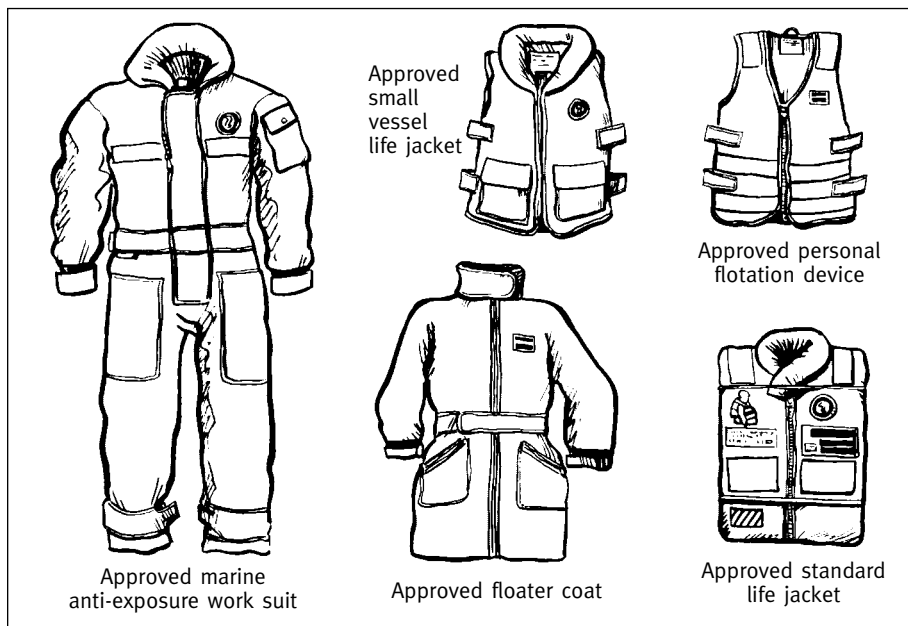

Figure 3.3: Various flotation devices

Buoyant devices are made from either kapok or unicellular foam. Despite the mildew inhibitor treatment required for the cloth, the webbing tapes, tape threads and certain areas of the envelope will occasionally rot. Seriously affected areas will appear aged, stained or otherwise discoloured. Kapok buoyant devices will frequently become waterlogged and unserviceable. This is most common with old devices exposed to oil vapours or new devices whose plastic pad covers have been punctured or remain wet and difficult to dry.

The regulations state that all boaters must carry buoyant devices to fit the persons on board. SAR units should carry some additional devices to accommodate the occasional passenger (injured, rescued persons, etc.).

A manufacturer seeking approval of life jackets and PFDs must receive approvals from the Ship Safety Branch, Transport Canada and the Underwriter's Laboratories of Canada (ULC). Life jackets are submitted to Ship Safety for initial design approval and then forwarded to ULC for testing; however, PFDs are initially submitted directly to ULC to begin testing. If the PFD meets all tested standards, it is then forwarded to Ship Safety for final approval and the issue of a certification number.

Three prototypes are required for laboratory testing; one is tested to destruction to determine suitability of material, workmanship and performance. If the tested sample meets the requirements of the relevant standard, the remaining two are stamped "Approved"; one is returned to the manufacturer for comparison with production models, and the other is retained for departmental records. A numbered certificate appears on the label of marketed items.

More than 20 models of life jackets and more than 100 different styles of PFDs, manufactured by 15 different companies, have been approved.

Recommendations on the best products available are not given because all approved models must meet the required standards. Users should purchase the most suitable for fit and comfort to satisfy the law and accommodate intended use. For example, a PFD suitable for paddling a canoe would probably be different from the device appropriate for merely sitting in a motorboat or sailboat, or for sailing. The boater should try out the device in the water to become familiar with its feel and capabilities. Since SAR personnel should wear PFDs at all times when on board, the only necessary recommendation is to choose PFDs that are comfortable and visible (red, orange or yellow).

3.3.2.2 Standard life jackets

The approved standard life jacket is mandatory equipment on all commercial vessels subject to Ship Safety Inspection and on all small fishing vessels under 15 tonnes G.R.T. (Gross Registered Tonnage).

The standard life jacket may substitute for any other personal buoyant device permitted on pleasure craft. The life jacket is manufactured to Transport Canada Specification TP 7318. This specification contains the Coast Guard Board of Steamship Inspection Requirements

for standard life jackets, incorporating the basic provisions in the International Convention of the Safety of Life at Sea (SOLAS), of which Canada is a signatory. These provisions cover such features as:

- workmanship and materials;
- buoyancy capabilities and wearability;
- head support, face and body position for an unconscious person in the water;
- effect of petroleum products; and
- colour.

Life jackets are manufactured in only one style – keyhole – but are available in two sizes. The adult size is designed for a body weight of 40 kg (90 lbs) or greater, and the child size for a body weight of 40 kg and under. All jackets should be fitted with whistle, retro-reflective tape and light. As of July 1991, owners of older type jackets should fit a whistle, reflecting tape and light to their jackets.

The main feature of a standard life jacket is its ability to turn an unconscious person in the water from face-down position to face-up, with the mouth and nose clear of the water. However, the bulkiness of the life jacket makes it quite uncomfortable to wear for long periods. Life jackets are to be donned when immersion is imminent (e.g., boat is sinking). SAR crews should use smaller but more comfortable PFDs.

3.3.2.3 Small vessel life jackets

Approved small vessel life jackets are for use on all pleasure craft and certain classes of small commercial craft (excluding fishing vessels) not subject to inspection by Transport Canada Ship Safety. They are designed and manufactured to Canadian General Standards Board (CGSB) Specification CAN 2-65.7-M80, drawn up and maintained under the auspices of the CGSB Committee on Life Jackets. This committee consists of representatives from the boating industry, safety organizations such as the Canada Safety Council, manufacturers, distributors and various government departments.

Small vessel life jackets are designed in two styles, one-piece (keyhole) and open-front (vest). They are also manufactured in three sizes: A for body weight over 41 kg, B for body weight between 18 kg and 41 kg, and C for body weight up to 18 kg. These devices have less buoyancy and righting moment than a standard life jacket, but must be able to turn the body to a safe flotation position once it enters the water. They must also support the head so that the face of an unconscious person is held above the water with the body inclined backward from the vertical position. There must be no tendency for the jacket to turn a body from any other position to face-down.

As for the standard life jacket, small vessel life jackets tend to be relatively uncomfortable. PFD's remain the best alternative for SAR crews.

3.3.2.4 Personal Flotation Devices (PFDs)

Approved personal flotation devices (PFDs) may be used in lieu of standard or small vessel life jackets on all pleasure craft, regardless of length, and are really designed to be worn constantly while boating. They represent the best balance of flotation, mobility and comfort.

PFDs are manufactured to CGSB Specification 65-11-M88 for adult sizes and to 65-15-M88 for children's. PFDs have less buoyancy and turning moment than life jackets. They must not have a tendency to turn the wearer face down in the water.

There are two approved types:

- Type I has inherent buoyancy capabilities due to its construction from unicellular foam or macrocellular elements.
- Type II has two buoyancy media: inherent features and inflatable capabilities. The inflatable section has an oral inflation device and a manual device consisting of a cylinder of compressed CO₂ operated by a manual trigger.

It is important that the PFDs be worn with straps and zippers fully fastened, and that the PFD be in good condition. Personal flotation devices are designed to offer padded protection for the front and back of the body during high-speed operations: their straps and buckles will stay fastened on impact with the water. A snug fit and slim design give the wearer comfort and mobility to work. Remember that PFD flotation foam will deteriorate after heavy use and exposure to the elements.

Recently, Transport Canada approved new colours such as blue and purple for PFDs used by recreational boaters. Some of these colours are not as visible as the standard red, yellow and orange PFDs. Those who work on the water usually choose the more visible colours to increase their chance of survival if they fall overboard. It is important to note that the approval for PFDs is valid only if the PFD is intact (no tears or holes) and unmodified (nothing has been glued, sewed or written on the PFD). Any PFD that has tears or holes should be replaced.

3.3.2.5 Anti-exposure work suits

Anti-exposure work suits (often referred to as flotation suits) are a good choice for operations in colder weather conditions or when water temperature may cause hypothermia. The flotation suit is one of the most common pieces of safety equipment being used by rescue personnel today because it offers warmth and protection as well as many pockets for carrying safety equipment. Flotation jackets can also be a good choice for warmer days. Some even have a beaver tail that straps between the legs to protect the groin area from heat loss. Both these flotation garments offer at least fifteen pounds (6.8 kg) of positive buoyancy, and some models incorporate an inflatable flotation collar that can be activated by an oral inflation hose. The flotation collar provides additional buoyancy about the head and shoulder area to keep the wearer's head clear of the water. Heat loss is greatly increased if water is allowed to circulate freely throughout the suit. Many designs have straps located

on the arms and legs that restrict the water flow when pulled tight. Maximum hypothermia protection is ensured when the hood is on the head, all zippers are fully closed, and all straps are fully tightened.

The most common designs of anti-exposure coveralls and jackets are not waterproof. These items can deteriorate rapidly if not properly washed and maintained. The foam flotation can break down and become matted and lumpy after a few years of use. When this occurs, the suit will no longer offer the positive buoyancy required to keep the head out of the water. Suits and jackets that are worn often should be replaced when the material begins to deteriorate. These garments will increase survival time in cold water, but do not offer the protection that a dry suit or a survival suit would. The full-exposure coveralls can severely limit swimming and movement, especially if they do not fit properly.

Suits that are damaged by small tears, broken zippers, open seams, or small burns may be repaired by sewing or patching. Suits that are more severely damaged should be removed from service.

After use, suits should be rinsed with fresh water and hung in a ventilated area to dry; do not expose to direct sunlight. Zippers should be periodically lubricated with paraffin or beeswax, which both lubricate and retard corrosion.

Flotation suits should not be dry-cleaned. Areas that become soiled may be washed with a mild soap solution, rinsed with fresh water, and then hung to dry in a ventilated area. Do not wring the suit. Do not attempt to use solvent or thinner to clean suits exposed to a substance containing acetone.

3.3.2.6 Testing the floating capability of PFDs and flotation suits

Vest pockets can be used for a wide variety of equipment, depending on the nature of work to be done. Pockets soon become full and the equipment vest becomes heavy. Fifteen pounds of buoyancy on your PFD will quickly become useless if you carry 30 pounds of equipment.

Weigh all your gear that you would wear on the heaviest day. If you are involved in enforcement, weigh the bulletproof vest with trauma plate and full gun belt. If you are a surveyor, weigh your survey vest and other necessary equipment. Rig a diving weight belt to the equivalent weight and put on your PFD. Now jump into a swimming pool and see how many minutes you can tread water. If you sink to the bottom like an anchor, you should re-evaluate the equipment you carry with you and/or your flotation.

The weight test can also be used to determine whether a flotation device is still in good condition. For this test, look at the label to find out how many pounds or kilograms the device is supposed to support. Rig a weight belt to that weight and attach it to the flotation device. Drop everything in a pool. Does the flotation device float or sink? Small variations between the rated buoyancy and the actual buoyancy may be acceptable, but any significant difference would suggest that the flotation device needs to be replaced.

3.3.3 Abandonment immersion suit

An abandonment immersion suit is a heavy rubber abandonment suit that is somewhat similar to a diver's dry suit. The suit provides excellent thermal protection and flotation, especially when the inflatable bladder is activated. These suits are designed as abandonment devices and should NOT be viewed as working flotation devices such as a standard life jackets or anti-exposure work suits.

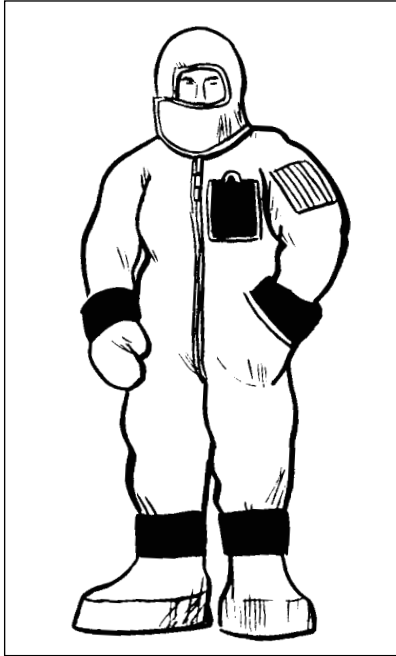

These suits must be checked periodically for holes, punctures, rips, etc., and to ensure that the teeth of the suit's zipper are aligned and that the zipper works all the way up and down. The zipper should be periodically lubricated with beeswax or a bar of soap.

Owners of abandonment immersion suits are encouraged to practice donning their suits in all kinds of conditions (at night, in rough weather, etc.) to simulate actual emergency conditions. A device to assist with pulling the zipper can be used. Whistles, strobe lights, flares, etc. should be stored with, or attached to the suit. Suits should be stored in an accessible location for quick and easy access in an emergency situation. Many manufacturers of survival suits recommend factory servicing of the suits every five years, but owners of these suits can try them on at least once a year in the water to check for small leaks.

Figure 3.4: An immersion suit

An immersion suit is truly the best thing one could wish to be wearing while floating in cold water. It keeps dry and it is very well insulated. The only problem is mobility. With big floppy arms, feet, and thick neoprene rubber, the immersion suit is almost impossible to walk or move in. It is solely designed for survival in case of immersion.

3.3.4 Dry suits

3.3.4.1 General

The most effective way to keep warm is to stay dry. A lightweight dry suit offers the best balance of dryness and mobility in cold weather. The dry suit is ideal for extended missions in severe climactic and marine conditions. SAR dry suits are usually similar to diving dry suits, but they have no valves. Hoods are not attached and the suit is worn with a thermal liner. Wrist and neck seals can be made of latex or neoprene. The choice of seal is often a matter of personal preference. Refer to the manufacturer for specific information regarding the choice of seals. Some dry suits also have integral work boots or soft-shoes. Dry suits are not approved as flotation devices; consequently, they must always be worn with a PFD. Dry suits can be punctured. When this occurs, the inherent buoyancy provided by the suit will be lost. This is why an approved PFD must be worn over the dry suit.

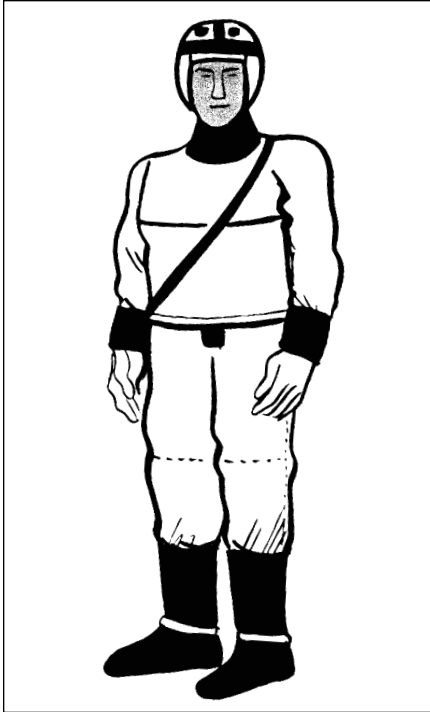

Dry suits alone do not provide adequate insulation or hypothermia protection. Thermal underwear must be worn beneath the dry suit to provide insulation. In areas of very cold water temperatures, layering of underwear is recommended. Always use underwear that is specifically designed to keep you warm in a wet environment.

Dry suits are among the most expensive items of personal protection for SAR crews. To perform their function of providing protection from the elements, they do require some specialized maintenance routines. With proper care and maintenance, they can fulfil their purpose for extended periods of time. Always refer to manufacturer's guidelines in order to make proper usage of the dry suit in matters such as donning and removing the suit.

Figure 3.5: A SAR lightweight dry suit

3.3.4.2 Dry suit maintenance

To prolong the life of the dry suit and ensure that it is ready for your next use, the following steps should be followed after each use:

- Close the zippers and rinse the suit thoroughly to remove salt or other contamination;
- Pay special attention to folds and creases;
- Clean the zipper teeth and outer zipper guard (if fitted) with a soft wet brush, such as a toothbrush, to remove dirt and salt;
- Thoroughly wash all seals, inside and out, using a mild soap-and-water solution to remove body oils or other contaminants;
- If required, turn the suit inside out and rinse with fresh water;
- When cleaning is completed, hang the suit on a sturdy wooden or plastic hanger to dry. The inside of the suit should be dried first, and then the outside. Do not expose the suit to bright sunlight or excessive heat. Do provide adequate circulation;
- Once a month or as required, lubricate the zippers with paraffin wax or beeswax on both the inside and the outside of the teeth. Do not use hand soap or silicone spray;
- Protect the seals in accordance with the manufacturer's recommendations. Unscented talcum powder can be used on seals. Do not use baby powder. Do not apply lubricants of any kind to seals.

3.3.4.3 Dry suit storage

Dry suits should be stored with the entry zipper completely open. They should be folded with the zipper on the outside and stored in a protective bag.

3.3.4.4 Repairs

Dry suits cannot usually be repaired in the field. Many suits come with a manufacturer's warranty for repair of defects. Always contact the manufacturer if your dry suit needs repair.

The only temporary repair that can be done in the field is replacement of a defective latex wrist seal when used with dry gloves and wrist rings. Note that this is useful only when the leak is located somewhere above the ring. If it is located between the ring and the sleeve, you will have no other choice but to have the seal replaced.

3.3.4.5 Thermal underwear

Thermal underwear constructed of polypropylene fibres provides good insulating value in a marine environment. Maximum protection from hypothermia can be achieved by layering thermal underwear. Polypropylene tends to keep moisture away from the wearer, increasing comfort and aiding in reduction of heat stress. The best wicking characteristics are obtained when the fabric is worn next to the skin.

To achieve maximum cold protection, it is a good idea to use layering. Tight polypropylene or polyester light underwear will keep the moisture away from your skin, and additional heavy underwear will provide insulation.

Cleaning routines for thermal underwear are limited to laundering after use. Polypropylene underwear should be washed by machine in warm water up to 38°C, and rinsed in cold water. Air-drying is recommended, but a dryer on permanent-press cycle may be used.

3.3.5 Equipment vest

Equipment vests are made of lightweight material and are designed to be worn over a PFD. The following pieces of equipment can be stored in the equipment vest:

3.3.5.1 Strobe light

A small waterproof strobe light can also be used to attract attention. Strobe lights are especially useful if you need to be seen at night. Some models will activate automatically in contact with water. This is a useful feature since it will increase your chances of being detected even if you are unconscious in the water and unable to use whistles, flashlights or voice to assist in detection. Other models need manual activation.

The personal emergency strobe light emits a high-intensity flashing white light of 40-60 flashes per minute, visible for two miles. It may be used to attract the attention of aircraft, ships, or ground search parties. A lanyard must be fastened to the light and to the wearer's clothing to prevent loss of the light during use. The lanyard should be of sufficient length to allow the arm to be extended to the maximum reach with the light held in the hand.

Personal strobe lights should be worn by all individuals engaged in SAR operations in periods of low visibility. The strobe light should be activated and checked at least once every patrol. This check includes:

- a physical examination of the body, clear light cover, and switch, including protective boot cover, for damage;
- a check of the battery date for expiry (generally one year from manufacturing date);
- a check of the lanyard for security and condition of cord; and
- activation of the light to check functional operation.

When donning safety gear for use, you should check the strobe light by activating the switch for a couple of flashes before proceeding with the task.

3.3.5.2 Personal distress flares

It is highly recommended that a minimum of three personal distress flares (type B) be carried by all crewmembers embarking on small SAR vessels during hours of darkness. Flares are normally carried in a pocket of the equipment vest, flotation jacket or dry suit or in a fanny pack with other items of personal safety gear.

The type B distress flare produces at least two red stars at intervals of not less than 15 seconds. The stars are projected to an altitude of not less than 90 m (300 ft.). The stars burn with a luminosity of not less than 5,000 candela for a period of not less than four seconds, and burn out before touching the sea. The type B distress signal may contain a firing device capable of throwing the stars automatically or may use a cartridge-firing device that requires loading for each star.

WARNING

SAR crewmembers should not be asked to carry and use cartridge-fired devices as personal flares. Firing these devices by a crewmember in the water requires a degree of coordination and dexterity not needed for self-contained devices. Coordination and dexterity may be depressed by the effect of hypothermia, causing the act of firing the cartridge type to be very difficult. It is recommended that SAR crews use the compact type of flares to allow easy fitting and comfort in pockets of work suits and clothing. All SAR personnel should be well informed regarding the firing procedure for these flares. Seek training if necessary.

All distress flares approved for marine use in Canada have an expiry date of four years from the date of manufacture. Check the dates on your flares regularly and take steps to procure replacements before the expiry date.

Flares should be inspected weekly by the individual to whom they are issued, outside the vessel or buildings in an open area. Handle flares with care, and be particularly careful not to pull on the launch cord or chain while conducting the inspection.

- Check the manufacturing date on the flares to ascertain whether they are still within the four-year period of approval. If expired, replace the flares with fresh ones and dispose of the outdated flares in the manner approved for your region;
- Check the flares for splitting, cracking, loose caps or any other signs of deterioration;

- Check the waterproof wrappings on your flares to ensure that they are still watertight. If the wrapping is not watertight, replace it with a new zip-top bag;
- Replace the flares into their designated stowage pouch or pocket.

3.3.5.3 Whistle

The whistle is a sound-signaling device that can be heard at distances greater than 300 m at sea. It is an effective and inexpensive item of personal protective equipment that has been instrumental in locating and saving many lives at sea. Yet, care and maintenance of this simple piece of equipment are often ignored.

A whistle should be attached to every crewmember's equipment vest zipper. Units that do not have equipment vests may attach the whistles to the zippers of PFDs, jackets and flotation suits.

Whistles should be of a type intended for marine use, such as standard life jacket whistles. Choose a unit that has no moving parts (peas), is compact and break-resistant and, above all, produces a loud piercing tone during use.

Whistles should be checked frequently for cracks, breaks, or deterioration. Ensure that the whistle remains securely fastened to the item of personal flotation and that it can be brought to the wearer's mouth without removing it. In addition, if the wearer is immersed in water, the whistle must reach his or her mouth without the need to put the face into the water. Test the whistle by blowing into it. Replace any whistle that fails the physical examination or fails to sound a loud shrill tone.

3.3.5.4 Heliograph

In addition to flares, strobe lights, and whistles, some SAR units issue an emergency-signaling mirror. The emergency signaling mirror is a compact unit that is used to attract the attention of passing aircraft or boats by reflecting light at them. The reflected light may be seen from two to four miles from the point of origin. The signaling mirror is used and maintained in accordance with the manufacturer's specifications. A weekly inspection of the mirror should be conducted to ensure that the surface is clean and polished, and the lanyard secure and in good condition.

3.3.5.5 Dye marker

This device releases into the water a green dye that greatly increases visibility from the air.

3.3.5.6 Flashlight

A flashlight can be used to attract attention on the water and serve as an effective tool at night on the boat. Waterproof flashlights are preferable for obvious reasons. Check the batteries once a week and lubricate the o-rings with silicone grease or spray before closing the flashlight. Rinse your flashlight with fresh water after exposure to salt water.

3.3.5.7 Portable VHF radio

Many crew are also carrying a waterproof portable VHF radio in their vest. The portable radio can be used to call for help when needed or anytime one crewmember gets separated from the rest of the crew. Note that some new models are compatible with GMDSS (a useful feature).

3.3.5.8 Knife

A knife is always handy. It is a good idea to have one in one of the pockets of the equipment vest. A lanyard should be used to keep the knife attached to the vest. Choose a blade that is designed to cut lines and that has good resistance to corrosion. Knives designed for scuba diving and kayaking often provide adequate resistance to corrosion. Always rinse your knife with fresh water after exposure to salt water. Dry your knife before putting it into storage. Keep your knife sharp and lubricate the blade once in a while with a fine layer of oil to increase resistance to corrosion.

3.3.6 Additional gear

Some extra equipment is advisable for spending long hours on the water. Extra gloves and an extra hat are always a good choice. High energy snacks like granola bars or peanuts will get the crew through long hours at night or long patrols.

3.3.7 General cleaning routines for protective clothing

Salt, corrosion and grease are the main enemies of safety gear. Given time, salt can cut material like a knife, transforming a dry suit into a wet suit and a rain jacket into a well-ventilated jacket. The salt molecules penetrate the fibres while in solution and crystallize when they dry. These crystals then cut the fabric during normal motion. Rinse your gear thoroughly with fresh water.

Grease should be washed out with a mild non-abrasive detergent and all zippers, metal buckles, and brass snaps or buttons should be protected with silicone spray or glycerin (hand soap). Keep your gear like new.

CHAPTER 4 – VESSEL SAFETY

4.1	Checklists and inspection of equipment	4-3
4.1.1	How and what to inspect	4-3
4.1.2	Sample inspection checklist	4-9
4.2	Maintenance and repairs	4-11
4.2.1	General	4-11
4.2.2	Routine maintenance	4-11
4.2.3	Boat mechanics and troubleshooting	4-11
4.2.3.1	General	4-11
4.2.3.2	Hull	4-12
4.2.3.3	Tubes	4-14
4.2.4	Outboard engine systems	4-19
4.2.4.1	Fuel and oil	4-19
4.2.4.2	Clutch, throttle and gears	4-20
4.2.4.3	Power tilt and trim	4-21
4.2.4.4	Propellers and attachment system	4-21
4.2.4.5	Batteries and electric systems	4-22
4.2.4.6	Engine cooling system	4-23
4.2.4.7	Engine alarms	4-23
4.2.5	Troubleshooting basic mechanical problems	4-24
4.2.5.1	Introduction	4-24
4.2.5.2	Troubleshooting diesel engines	4-24
4.2.5.3	Problems common to both gasoline and diesel engines	4-29
4.2.5.4	Outboard motor troubleshooting	4-33
4.2.5.5	Troubleshooting steering gear failure	4-35
4.3	SAR equipment	4-36
4.3.1	Binoculars	4-36
4.3.2	Night vision goggles	4-36
4.3.3	Searchlight	4-36
4.3.4	Flashlight	4-37
4.3.5	Life buoys	4-37
4.3.6	Throw-bags	4-37
4.3.7	Rescue extension	4-37
4.3.8	Fire extinguishers	4-37

4.3.9	Rescue frame	4-37
4.3.10	SAR pumps	4-38
4.4	Trailing a boat	4-38
4.4.1	General	4-38
4.4.2	Trailer capacity	4-38
4.4.3	Balancing and securing the boat	4-39
4.4.4	Pre-departure checklist	4-40
4.4.5	As you trailer	4-40
4.4.6	Launching the boat	4-40
4.4.7	Recovering the boat	4-41
4.4.8	Trailer maintenance	4-41
4.4.9	You and the law	4-42
4.5	On board emergencies	4-42
4.5.1	Person overboard	4-42
4.5.1.1	Recovery procedure	4-42
4.5.1.2	Anderson (one-turn) manoeuvre	4-44
4.5.1.3	Williamson manoeuvre	4-44
4.5.2	Accidental grounding	4-45
4.5.2.1	General	4-45
4.5.2.2	Accidental-grounding checklist	4-46
4.5.3	Emergency procedure in the event of capsizing	4-46
4.5.3.1	General	4-46
4.5.3.2	Prevention	4-46
4.5.3.3	Precautions	4-47
4.5.3.4	Escape procedures	4-47
4.5.3.5	Alongside a capsized boat	4-48
4.5.3.6	Remaining inside a capsized boat	4-48
4.5.3.7	Self-righting techniques for an RHIB	4-48
4.5.4	Injury to a crewmember	4-51
4.5.5	Becoming disoriented	4-52
4.5.6	Fire on board	4-52
4.5.6.1	Opening a hatch	4-53

4 VESSEL SAFETY

4.1 CHECKLISTS AND INSPECTION OF EQUIPMENT

It is very important to inspect your vessel and equipment regularly. For a vessel that has to maintain daily or frequent SAR standby, a thorough inspection should be performed at the beginning of each week, and daily routine inspection should then be performed. In this section, you will find descriptions of how and what to inspect and examples of inspection checklists.

4.1.1 How and what to inspect

The following table gives a list of items to inspect and the way to inspect them:

Table 4.1: Description of items that should be inspected and how they should be inspected

What to Inspect	How to Inspect
PFDs or other flotation devices	<p>Ensure that you have one for everybody on board, readily accessible;</p> <p>Store in a cool, dry place out of direct sunlight, away from oil, paint and greasy substances;</p> <p>Check all closures, straps, etc.;</p> <p>Check general condition (tears, mildew, discolouration, etc.);</p> <p>Check that retro-reflective material (required on all PFDs) is in good condition;</p> <p>All PFDs in service shall be outfitted with a whistle and a distress signal light secured to the PFD (battery operated strobe light or the Personnel Marker Light chemical light);</p> <p>If a PFD requires cleaning, wash it in fresh, warm water with a mild detergent; then rinse in clean, fresh water.</p>
Survival knife	<p>Stowed properly in sheath, and may also be carried or worn by crew members;</p> <p>Not corroded and sharp (sharpen if necessary);</p> <p>Diver's knife is the best choice for a survival knife – it should be double edged and corrosion resistant;</p> <p>Easily accessible.</p>

What to Inspect	How to Inspect
Distress flares and illuminating flares	<p>Check date of manufacture, ensure 4-year validity and approval;</p> <p>Ensure you have enough for the length of your vessel;</p> <p>Container is watertight;</p> <p>No traces of external damage;</p> <p>Readily accessible.</p>
Anchor	<p>Ensure that rope is firmly attached to the vessel. The rope is the line from the boat to the anchor and is usually made up of a length of line plus a short length of chain. Large boats may use an all-chain rope. Each element of the system must be connected to its neighbour in a strong and dependable manner. The most commonly used line for rope is nylon. The line may be either cable laid or braided, and must be free of cuts and abrasions. Foot or fathom markers may be placed in the line to aid in paying out the proper amount of anchor rope;</p> <p>Check the rope (chafing, knots, etc.);</p> <p>Ensure that the shackle pin is not unscrewed and will not unscrew.</p>
Bailer	<p>Ensure you have one available;</p> <p>Check for accessibility and condition.</p>
Bilge pumps	<p>Ensure they are in working order;</p> <p>Ensure that input in bilge is free from obstructions;</p> <p>Ensure discharge hose does not leak, especially connections at discharge port through hull;</p> <p>Ensure that discharge hoses of manual pumps are long enough to pump outside the vessel.</p>
Vessel markings	<p>Ensure that all markings are visible;</p> <p>Ensure that all characters are present.</p>

What to Inspect	How to Inspect
Fire extinguishers	Ensure that you have enough to comply with regulations; Check for powder leakage at the nozzle; Condition of the cylinder (no deformation, rust, etc.); Seal is present; Pressure gauge indicates full; Easily accessible.
SAR pumps (portable, gasoline-powered drop pump)	Read and follow the manufacturing instructions for usage and maintenance; Secured in an aluminum floatable watertight container, stowed on deck or in a properly ventilated locker; Centrifugal and self-priming; Suction hose with strainer and discharge hose; Test weekly and before moving to another boat; Do not use a drop pump to dewater a boat with fuel contamination in its bilges; Flush pump and hoses with fresh water if they have been used in saltwater environment; Always ensure that gasoline is fresh.
Blower	Ensure that it works; Check intake pipe and ensure it is at the appropriate level; Place your hand near the output and ensure that you can feel the air coming out.
Life buoys	Stowed so they can be quickly thrown overboard in an emergency; Transport Canada approved; Attached to a buoyant line not less than 15 m (49 ft.) in length; Look for any sign of damage, wear and tear; Ensure that grab lines are well secured; Ensure that they are easily accessible; Check retro-reflective tape and light (if present).

What to Inspect	How to Inspect
Throwable devices	Check the line and ensure that it floats; Coil line properly (if applicable); Ensure that they are easily accessible.
Fixed searchlight	Ensure that light is working and easy to move.
Navigation lights and blue flashing light	Ensure that all are working; Ensure that all lights are visible (not covered by anything).
Radar reflector	Check general condition; Ensure that attachment points are solid; If possible, test efficacy with another vessel equipped with a radar.
Horn	Sound it to ensure that it works.
Batteries and electrical connections	Ensure that they are secured and protected; Check wires (clean, no chafing, etc.); Ensure that all connections are tight and clean; Ensure that there are no breaks in insulation in wires.
Electrical distribution panel	Ensure breakers are in normal position; if not, check for potential short-circuits.
Oil system	Fill oil tanks; Check system for leaks; Ensure that ports are tight and clean.
Fuel system	Fill tanks; Inspect lines and hoses for leaks and free movement.

What to Inspect	How to Inspect
Tow assembly	<p>Tow reel tightly attached to vessel (deck fitting);</p> <p>Line is properly secured;</p> <p>Reel is not loose in holders;</p> <p>Inspect towlines on a regular basis to detect damage from cuts, chafing, flattening, fusing (caused by overheating or over-stretching), snags and hardening (heavy use will compact and harden a towline and reduce its breaking strength);</p> <p>Check messenger (heaving line or heaving ball), drogue and skiff hook.</p>
Cage	<p>Cage and engine bar are tightly bolted to the vessel;</p> <p>No cracks or deformations in welds or pipes;</p> <p>All structural bolts are tight;</p> <p>No delaminations or cracks in metal/fibreglass joints.</p>
Antennae and radar scanner	<p>Tightly secured to mountings;</p> <p>Coaxial connections and wiring secure and not chafing.</p>
Self-righting system	<p>Check bag for proper storage;</p> <p>Cylinder and firing head secure in mounting;</p> <p>Lanyard tight, not chafing;</p> <p>Handle clipped to transom.</p>
Personnel recovery line	<p>Bag tightly laced to cage or engine guard bar;</p> <p>Line properly stowed and bag closed properly.</p>
Marine VHF radio	<p>Connections are tight;</p> <p>Test with another radio for reception and transmission.</p>
Global Positioning System	<p>Connections are tight;</p> <p>Can read satellite signals and provide reliable position;</p> <p>Secure in mounting.</p>

What to Inspect	How to Inspect
Radar	Proper acquisition of picture; All functions working properly.
Depth sounder	Gives an appropriate reading.
Tube of inflatable boats	Tube must be rigid and fully inflated; Inflate if necessary; Check valves for leaks and proper operation.
Propulsion and steering systems	Check tilt and trim system (if applicable); Check propellers and skegs for signs of damage; Turn wheel completely to both sides, and ensure that it works well; Start engines, check water cooling system telltales (if applicable); Engage forward and backward while docked to ensure that everything works smoothly (no chatter noise); Check RPMs at idle.
Rescue and survival raft (6-person raft to rescue others)	Properly stowed and certified.

4.1.2 Sample inspection checklist

The following table is a good example of a daily inspection checklist. This checklist is intended to be used on an RHIB, but it can certainly be easily modified for use on your unit.

Table 4.2: Daily inspection checklist covering an entire week

Item	S	M	T	W	T	F	S
PFDs							
Tube pressure							
Batteries							
Electrical connections							
Oil levels							
Fuel levels							
Tow assembly							
Cage							
Antennae (VHF, Radar, GPS, etc.)							
Self-righting system							
Personnel recovery line							
Knife							
Radio (Radio test)							
GPS							
Radar							
Sounder							
Navigation lights							
SAR strobe							
Instruments (including gauge lights)							
Bilge pumps							
Horn							
Steering							
Search lights							
Tool kit and spare parts							
EPIRB							
Sea anchor							

Élément	D	L	M	M	J	V	S
Anchor and rode							
Bailer							
Datum marker buoy (DMB)							
SAR pump (fuel and oil)							
Buoyant heaving line							
Paddles							
Flares							
First aid kit							
Fire extinguishers							
Tighten all loose bolts							
Tilt/trim (port / starboard)							
Propellers, skegs (P / S)							
Engine hours (P / S)							
RPM at idle (P / S)							
Telltale (P / S)							
Kill switches (P / S)							

4.2 MAINTENANCE AND REPAIRS

4.2.1 General

This section will provide some information on maintaining and conducting small or temporary repairs to certain kinds of vessels. Since it is impossible to cover the specifics of every kind of vessel that can be engaged in SAR, the reader is encouraged to seek complementary information in the owner's manuals that accompany the boat and engine(s) they are using.

It is important to perform a complete inspection of the vessel any time damage is suspected to have occurred. Reasons for this are numerous. First, small damage can become huge when not repaired in time.

All CCGA members are reminded that in the event of an accident or damage to their vessel during authorized activities, regional procedures MUST be followed. It is essential that all claims be reported immediately to the appropriate Coast Guard authority. Except for emergency measures needed to stay afloat, no insured repairs may be undertaken until approval has been obtained from Coast Guard and/or insurers. Claims should be reported in the first instance by telephone, and the Collision Wreck and Injury Report should then be submitted. CCGA members are encouraged to carefully read the brochure entitled "National Guidelines Respecting Canadian Coast Guard Auxiliary Activities" for additional information on their insurance coverage.

4.2.2 Routine maintenance

"Life Saving Vessels fulfill their function under conditions which, for other craft and equipment, are regarded as extreme – to be avoided, if possible. Thus, the concept of 'Acceptable risk of failure' cannot apply. It is when other vessels have failed that the life saving vessel must work."

*Per G. Klern, Senior Research Engineer,
Norwegian Ship Research Institute*

The above quotation stresses the importance of maintenance. Vessels engaged in SAR should have a rigid maintenance schedule. Everything should be in full working order, and daily checklists should be used for daily vessel inspections. Vessels engaged in SAR that are not well maintained are quite likely to fail, thus becoming part of the problem instead of part of the solution.

4.2.3 Boat mechanics and troubleshooting

4.2.3.1 General

Mechanical failures are always a big problem for vessels engaged in SAR; they can adversely affect the state of readiness of the unit and even jeopardize the safety of the crew. This section should provide adequate information on how to deal with mechanical failures.

A description of the basic concepts pertaining to hulls, tubes and engines will be followed by a look at engine and equipment troubleshooting. The discussion on engines will focus on outboard engines, since these are widely used. However, the troubleshooting section will address both inboard and outboard engine mechanical problems.

4.2.3.2 Hull

Many vessels engaged in SAR have fibreglass hulls. The core of fibreglass hulls can be made from balsa wood, foam or other manmade fibres. Some core material will absorb water if the protective gel coat applied on the outside of the hull is cracked or damaged. To prevent water absorption into the core, it is essential to repair cracks in the gel coat as soon as they are discovered. Small cracks above the waterline can be easily repaired. To repair deeper scratches or cracks that lie below the waterline, removing the boat from the water, and possibly to a shop, will be necessary.

Before attempting any gel coat repairs, be sure to wear the proper protective clothing. Repairs should be done in a ventilated area and a controlled environment. Remember that large holes or deep damage will need to be repaired in a shop. The following figures illustrates the procedure for repairing gel coat damage:

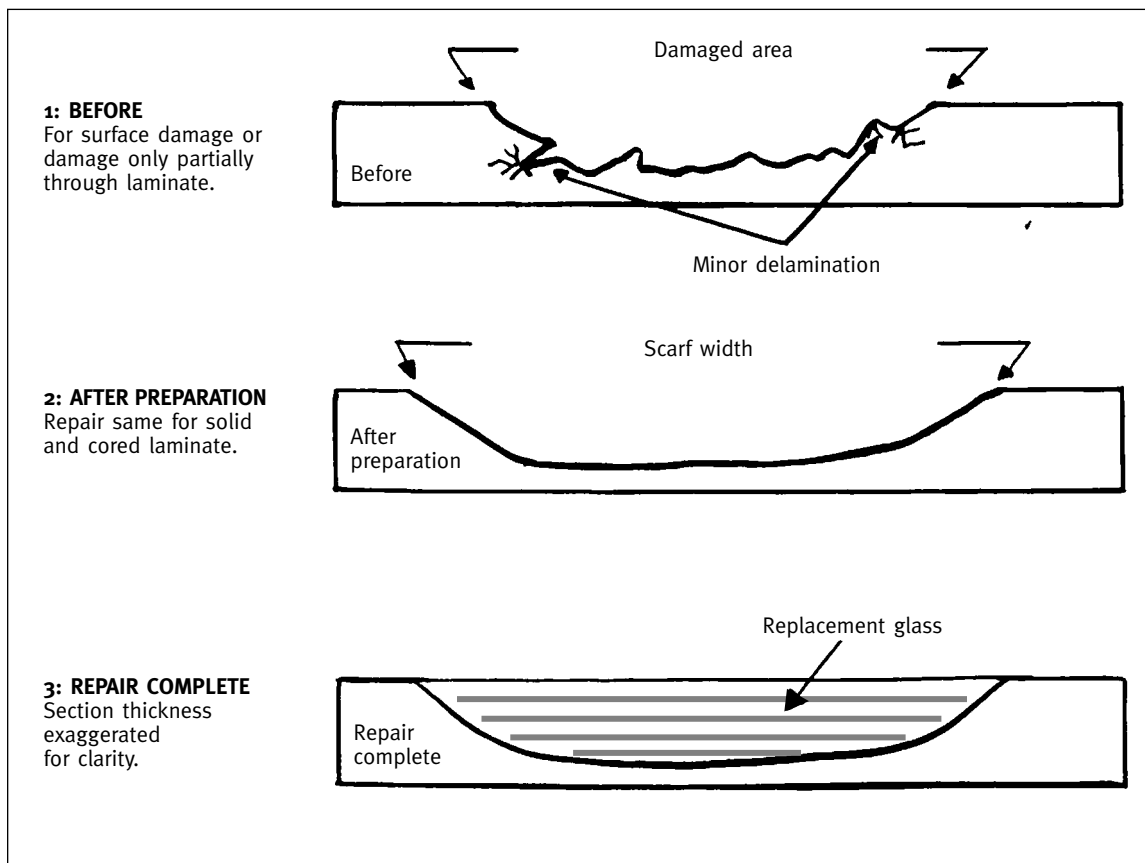

Figure 4.1a: FRP Repair Procedure – Type 1

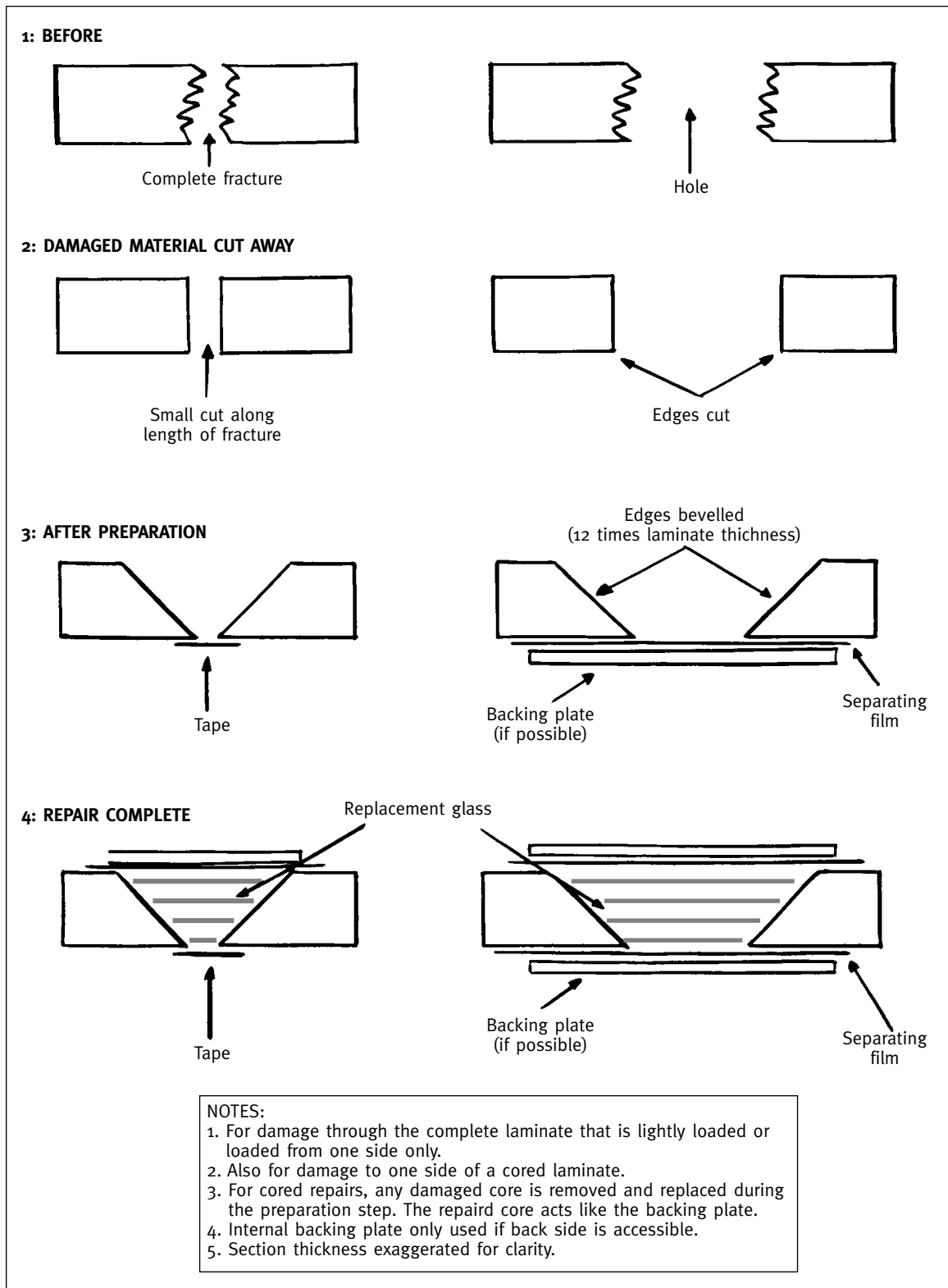

Figure 4.1b: FRP Repair Procedure – Type 2

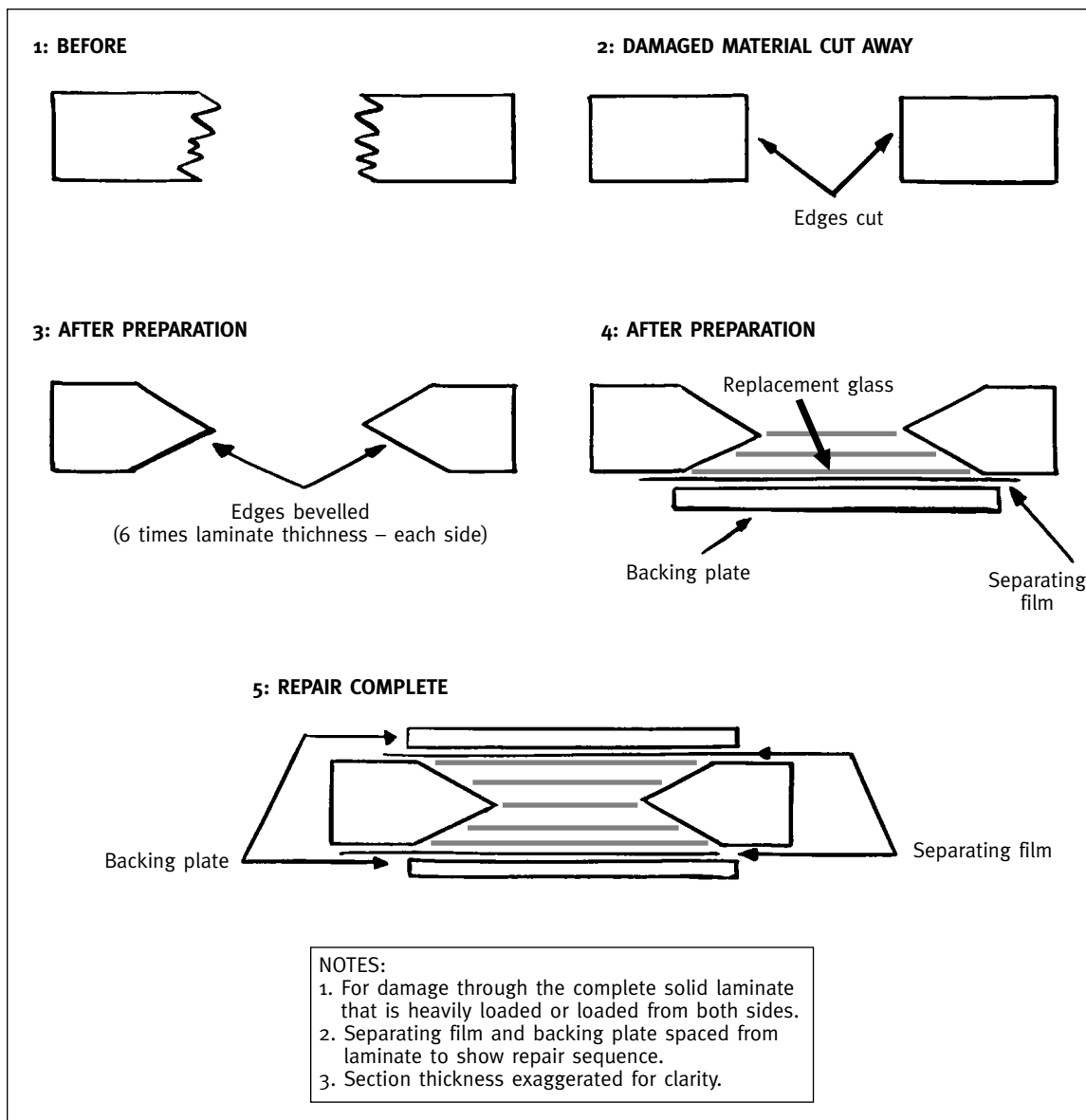

Figure 4.1c: FRP Repair Procedure – Type 3

4.2.3.3 Tubes

The tubes of inflatable boats usually consist of a three-layered fabric. The centre layer is some kind of heavy canvas. Kevlar threads are often woven into the fabric to provide resistance to tearing. The inner layer really provides air integrity, while the external layer provides both air integrity and strength (UV and abrasion resistance). The strength of the fabric is usually expressed in terms of denier rating. The denier rating is measured by stretching a piece of fabric on a tube. The pressure in the tube is then raised to the point where the fabric bursts. The pressure at which the air begins to go through the piece of fabric represents the denier rating for that particular fabric. The inner and external layer can be made from natural rubber compounds (e.g., hypalon and neoprene) or from synthetic polymers. It is important to determine the type of fabric before attempting any kind of tube repair, since procedures differ with fabric type.

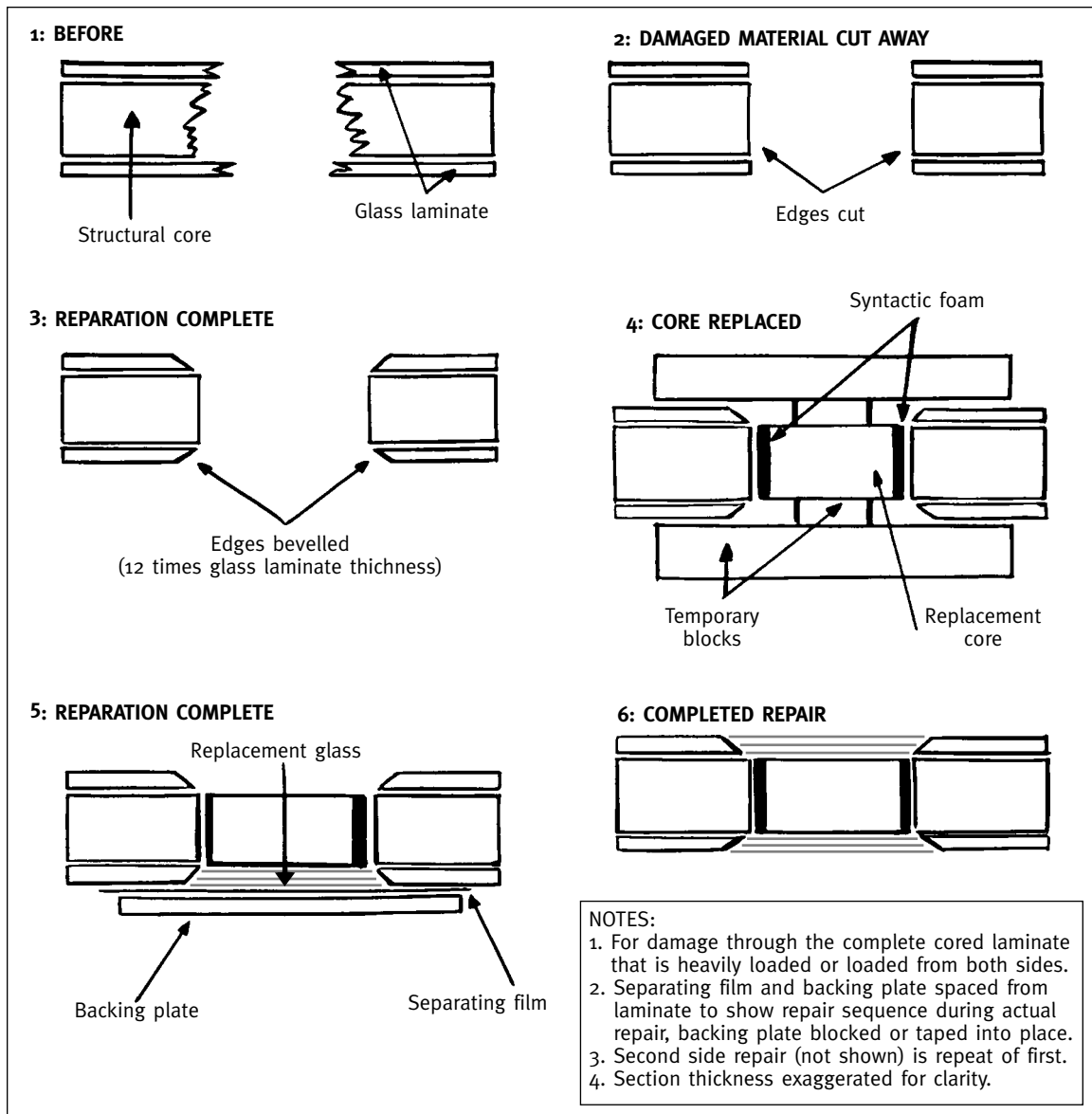

Figure 4.1d: FRP Repair Procedure – Type 4

Threads of the tube canvas are aligned in a perpendicular fashion. The threads in a longitudinal axis are called warp, while the threads that encircle the tube are called weft. The thread material that composes the warp and the weft is the same.

Repairing a tube

First, test the tubes for air retention if no damage is found. This testing will identify the leaking chamber. Inflate the chamber and brush a water/soap solution on the fabric. The leak is identified by a growing chain of bubbles or, if large enough, by a slight whistling sound. The leak will be in one of the following categories: valve leakage, cover patch leakage, seam leakage, wide spread leakage, hole or tear.

Some holes can be patched by a cautious crewmember, while others will need to be repaired in a shop. The following CANNOT be repaired by a crewmember:

- any hole or tear with a diameter or a length exceeding 2.5 cm (one inch) at any point;
- any hole or tear that is within 5 cm (two inches) of a seam;
- any seam leak.

All these will usually require both an inside and an outside patch. The inside patch can only be done by professionals. A temporary patch can be attempted by following the procedure described below. However, this patch must be redone properly at the first opportunity.

Small holes on the tube of inflatable boats can be patched easily. However, there are some important guidelines for ensuring maximum patch life. These guidelines must be followed to the letter. Any compromise will result in diminished patch life.

All patches must be applied in a controlled environment (relative humidity less than 70% and temperature between 18° and 25°C (64° to 77°F)). Avoid gluing when the tube is not protected from the sun. Heat will affect the strength of the chemical bonds. Humidity is also a crucial factor during the gluing process. Avoid breathing directly over the glue coatings. Some chemicals used in the repair process (glue or solvent) can be quite toxic.

The following safety precautions should be followed:

- Do not smoke or use glue or solvent near an open flame. Both are usually quite flammable;
- Repairs should be done in a well-ventilated area, because glue and especially solvents (MEK or toluene) can be very toxic;
- Accelerator (for glues that need to be mixed) is also very toxic. Wash any accelerator spilled on your skin immediately with soap and water. If accelerator is spilled in your eyes, rinse immediately with water. Consult a physician or call the nearest poison control centre before you stop the rinsing process.

General guidelines:

- Tubes of glue that require mixing must be entirely emptied. Once opened, accelerator cannot be kept. Using the whole tubes will also ensure proper mixing ratios and thus good bonding capacity. The quality of your patch depends on accurate mixing; do not compromise at this step;
- Use the appropriate glue! Some glues will work on hypalon or neoprene but not on synthetic material (or vice versa). Choose the right glue for the job;
- Choose a brush with short (1 to 2 cm) and stiff bristles to apply the glue. Avoid plastic brushes. A brush with natural hair bristles bound in metal and a wooden or metal handle is ideal;
- The threads of the patch must be aligned with the warp and weft of the tube. Failure to align will weaken the patch;
- The patch should exceed the hole's contour by two inches. Smaller patches are less likely to resist the pressure of the tube.

To patch a small hole:

- Cut a patch of the appropriate size. When cutting the patch, hold the scissors at an angle. Patches cut in this way are less likely to snag on other objects. Circular patches are usually better than rectangular ones. The corners of rectangular patches have a tendency to lift too easily and must be rounded (a quarter makes a good template for that purpose);
- Use a pumice stone or a proper tool to sand both the patch and the corresponding area on the tube. Do not sand an area on the tube bigger than the patch. Draw the contour of the patch on the tube and sand this area only. Draw a few guide marks to ease the alignment process. This step is essential to providing the rough area that will make the glue hold;
- Clean the areas that you have just prepared with methyl-ethyl-ketone (MEK) or toluene. Solvents should be handled with appropriate protective equipment (gloves, mask and goggles). Do not touch the cleaned areas with your hands. Oils on your hands may affect the efficacy of the glue;
- Repeat the cleaning process twice if you are patching a hypalon or neoprene tube and wait 10 minutes between the solvent washes;
- Repeat the cleaning process 3 times if you are patching a synthetic tube and wait 5 minutes between the solvent washes;
- Before mixing the glue with the hardener, ensure that the “best before” dates of these products have not yet been reached. Remember to use the exact ratio of glue and hardener. Be very precise, as any deviation from the usual ratio may result in weaker glue and thus, a low life expectancy patch. Using glues that do not require mixing can prevent the problem of inaccurate mixing;
- Apply THIN coats of glue on each surface. The coats should be applied first vertically, then horizontally. Always wait for the first coat to dry before applying the second. Leave a little bit of glue outside of the patch contour on the tube. This will allow you to test for dryness without contaminating the glue that will hold the patch. Test for dryness with the “knuckle test”;
- Apply 2 coats of glue if you are patching a hypalon or neoprene tube (drying time is about 20 to 30 minutes);
- Apply 3 coats of glue if you are patching a synthetic tube (drying time is about 5 to 10 minutes);
- Once the last coat is applied, let the glue dry for 10 minutes and then apply the patch (remember to align the threads!);
- Use a J-roller or another smooth tool (the back of a large metal spoon would work fine) to remove the air trapped between the patch and tube;
- Press as hard as you can;
- Start at the centre and work toward the edges;
- Once the patch is applied, allow at least 24 hours (ideally 48 hours), if possible, for the glue to dry before using the boat;
- The chemical bonds will continue to strengthen over the next seven days;
- Be careful with the patch until then.

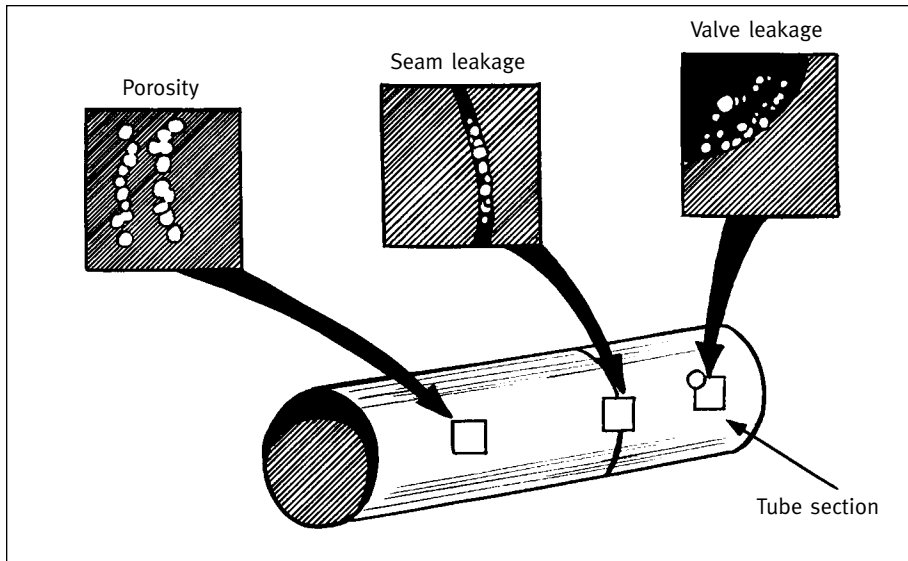

Figure 4.2: Soap test

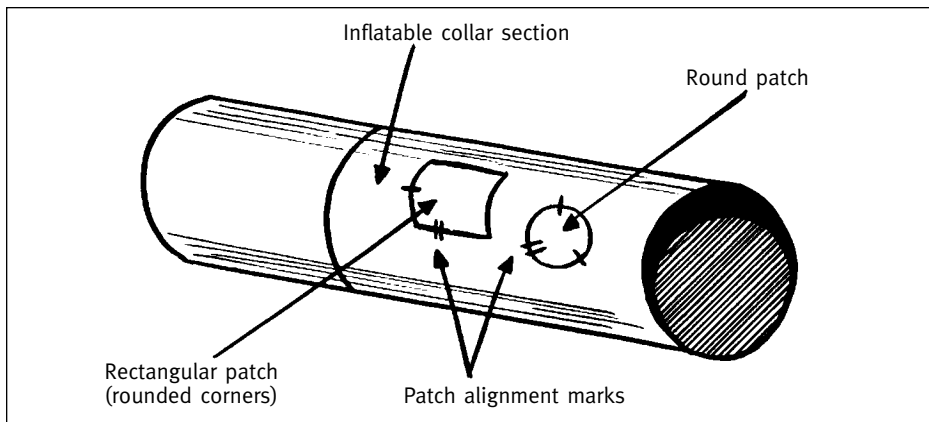

Figure 4.3: Patch application

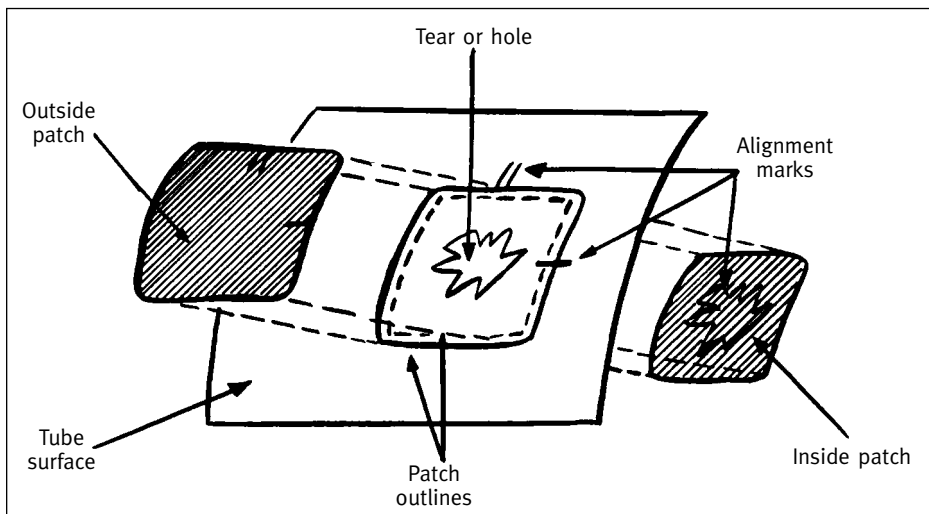

Figure 4.4: Inside out patch

Inflating a tube

Many RHIBs have cones inside their tubes. The main function of these cones is to allow the pressure to equalize between the compartments and to prevent total tube deflation when tearing occurs. For these cones to perform properly, the tube should be inflated by starting at the bow.

Valves

Accumulation of dirt in a valve can cause it to leak. Some valves can be checked in the field. Ensure that the valves on your unit can be opened in the field before attempting the following procedure. Plastic valves cannot be serviced in the field. When you need to check a leaking valve, proceed as follows:

- Deflate the tube by opening the valve;
- Once the tube is deflated, close the valve. If the valve remains open, the nut and spring of the valve may fall into the tube when you disassemble it;
- Use a cloth to clean the two metal surfaces of the valve. If you have valve lubricant, you may also lubricate the valve. Never use a petroleum-based lubricant on valves;
- Replace the spring and nut into their respective positions. Screw until the nut blocks, and then unscrew for six complete turns. This step is important, as it provides over-pressure safety. Unscrewing will allow air to escape if the pressure in the tube gets too high;
- Inflate the tube and check to determine whether the valve still leaks. If it does, the valve may need to be ground or replaced. Have a professional check the valve as soon as possible.

4.2.4 Outboard engine systems

This section details the basic components of outboard engine systems, with a focus on the things that can easily be temporarily repaired in the field. It should be noted that engines that undergo frequent routine maintenance are unlikely to fail often.

4.2.4.1 Fuel and oil

Outboard engines may have one or two oil tanks. Small outboards will have only one tank located on the engine itself. Larger engines will have another tank, usually located somewhere outside the engine.

Single oil tank engines

These engines have an oil tank directly on them. Hoses conduct the oil from the tank to inner parts of the engine. An oil filter can usually be seen somewhere in the hose. At one point, the oil hose will meet with the fuel line. This is where oil and gas will be mixed before entering the combustion chamber of the engine (2-stroke engines).

Dual oil tank engines

On dual oil tank engines, the main oil tank is the one that is located outside the engine. A hose coming out of the engine brings pressurized air into the tank, while another hose will bring the oil to the smaller (secondary) tank located on the engine. Since this system is driven by air pressure, all caps must be tightly closed; otherwise, air will escape and the pressure generated will not be sufficient. An oil filter is found at the base of the intake hose. An oil-level sensor is attached to the cap of the secondary tank. From the secondary tank, the usual tubing brings the oil to the engine.

Important notices regarding oil:

- Always use oil recommended by the engine manufacturer. Using other oils may void your warranty.
- In some engines, the quantity of oil that gets mixed with the gas is a function of RPM (rotations per minute). Consequently, it may be advisable to pour some oil in the gas tank when towing another vessel to ensure that the engine gets enough oil. Check with the engine manufacturer to find out whether this procedure is necessary for your engine(s).

Fuel tanks

Fuel tanks are usually located below the deck, near the middle of the boat. Hoses will bring the fuel to the engine. A valve somewhere along the hose is recommended. This valve can be closed in case of engine fire, thus reducing the risk of explosion. A primer bulb is also present somewhere on the hose. The engine has fuel pumps and filters. Hoses will allow the fuel to travel between these engine components.

4.2.4.2 Clutch, throttle and gears

This system controls the speed and direction of the propeller's rotation. A remote control located near the wheel allows the pilot to command this system. Wires will relay the movements of the handle to the corresponding engine parts. Although the same handle (on the remote control) commands both throttle and clutch, two different systems are activated on the engine each time you use that handle. The first system to be activated is the clutch. It will engage and the propeller will start to turn. Then, as you continue to push or pull on the remote control lever, the throttle will be activated and the engine will turn faster.

The gear system of an outboard engine is quite simple. The engine's movement is brought to the leg of the engine by the driveshaft. When the engine is running, the drive shaft turns continuously, always in the same direction. In the leg of the engine, gears (forward and reverse) are driven by the driveshaft. As for the driveshaft, both these gears will turn when the engine is running. The dog clutch is responsible for coupling the driveshaft movement to the propeller shaft. The dog clutch can slide forward or backward, attaching itself to the forward or reverse gear and thus making the propeller shaft turn clockwise or counter-clockwise. Sometimes, when the touch on the remote control level is too gentle, the dog clutch will not engage completely toward the gear. When this happens, a very characteristic chatter is produced and the dog clutch may be damaged.

4.2.4.3 Power tilt and trim

The power tilt and trim system is driven by electricity and is usually protected from power surges by a fuse that can be easily replaced if necessary. The power tilt and trim system has various functions. First, it allows the boat operator to modify the trim of the boat. This will affect the way the boat handles in various conditions (for details on this subject, consult the chapter on boat handling). Then, it allows the engines to be raised for shallow water manoeuvring or for putting the boat on a trailer. Lastly, it provides some impact protection to the leg of the engine. At slow speed, if the leg hits the bottom, the tilt mechanisms will allow the engine to move upward and thus reduce the risk of severe damage.

The engine's two speeds can be seen when the engine is lifted. The slower speed is mainly for trim adjustment, while the fastest speed allows the engine to be completely tilted. The fastest speed does not provide enough power to raise the leg of the engine out of the water during motion. Be aware that some systems do not have the second speed and that the engine may rise out of the water if not used properly.

The solenoid of the power tilt and trim system can be short-circuited to adjust the tilt of the engine when the switches are damaged. This manoeuver obviously cannot be performed while the boat is moving. The engine cover and the solenoid cover must be removed to access this solenoid.

4.2.4.4 Propellers and attachment system

There are several kinds of propellers. Propellers usually have two to five blades: some are made of aluminum and others are made from stainless steel. The advantages and disadvantages of the various kinds of propeller are beyond the scope of this manual. One thing might be worth mentioning however: aluminum propellers, because of their relative fragility, may prevent excessive damage to the engine if one happens to hit the bottom. Internal components of the engine are usually stronger than the propeller; thus, in this situation, the damage is more likely to be limited to the propeller.

In the case of a stainless steel propeller, things might be different. Units that often work in shallow water should consider this when choosing propellers. The pitch of the propeller is also an important characteristic. The pitch of a propeller represents the theoretical distance the propeller would travel in one turn in a solid medium. Choosing a properly-pitched propeller for your engine is important.

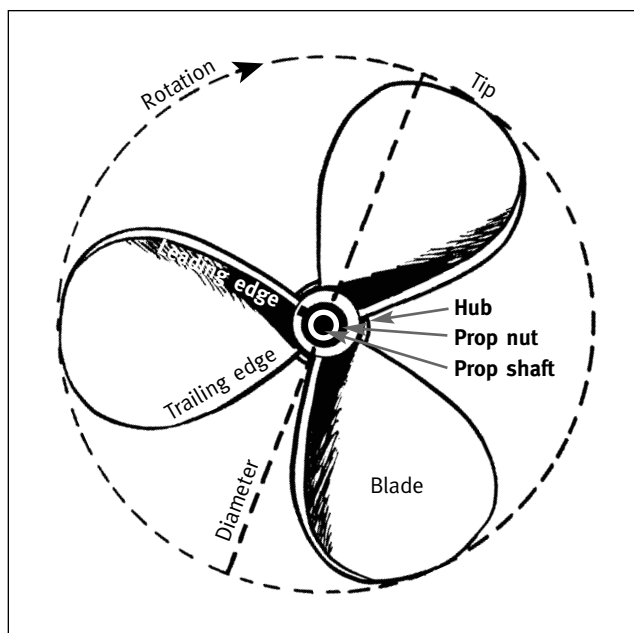

Figure 4.5: Parts of a propeller

The last important thing to mention about propellers is the following. Inside the body of the propeller is a bushing made of rubber. The goal of this bushing is to provide an elastic joint between the propeller shaft and the propeller. If the propeller hits the bottom while still turning, that bushing will absorb some of the impact. In some cases, it may also allow the propeller shaft to spin while the propeller is immobilized. Obviously, this bushing will eventually wear out. During attempts to move into planing mode (planing hull) or to rapidly build speed, worn out propeller bushing may fail. If this occurs, the RPM of the engine will rapidly rise without any noticeable speed gain.

Vessels equipped with two engines may need a counter-rotating propeller. On such vessels, the starboard propeller turns clockwise and the port propeller turns counterclockwise during forward movement. Two different propellers are thus needed.

The propeller is attached to the propeller shaft by a simple nut. This nut is blocked so that it cannot unscrew by itself. Pins or special washers are used to block the propeller nut. A thrust bushing prevents the propeller from being driven into the gear case during forward motion.

4.2.4.5 Batteries and electric systems

Batteries are needed to start the engine and to provide electricity to the spark plugs, to the tilt and trim system and to other engine or boat components. The engine produces alternating current (AC) when running. A current rectifier is used to convert that current into direct current (DC), which is used to recharge the batteries. That rectifier is likely to be damaged if the batteries are disconnected or if the battery switch is turned to “off” while the engine is running. If the circuit is interrupted between the running engines and the batteries, the current that is normally utilized to charge the batteries will be redirected to the other energy-consuming devices. The resulting surge will most likely cause significant damage to all electric and electronic devices on board. If you want to avoid costly repairs, never ever disconnect the batteries or turn the battery switch off while the engines are running!

Another safety rule is to always leave the navigation lights on to prevent overcharged batteries. This rule is especially important when the engines are at high RPMs. Be warned that an overcharged battery may explode. Finally, all batteries used on all self-righting vessels should have aviation caps installed to prevent spillage of battery acid after capsizing.

When the engine is started, electricity is used to make the flywheel turn. Usually, after a few turns, the engine will start and fuel will be then used to drive the engine. An electric starter is used as to drive the flywheel into the initial turns. This starter is really a small electric engine. When the key is turned, electric current moves into the starter, a gear engages on the flywheel and the engine starts to turn. A solenoid controls the whole process. An engine can be started without keys by short-circuiting that solenoid with a metal wire of the right size.

4.2.4.6 Engine cooling system

The engine is cooled by water. The water intake and the water pump are located in the gear case. The water pump is driven by the driveshaft. The pump consists of a rubber impeller that turns and propels the water. That impeller is relatively fragile and can easily be damaged. The most frequent causes of impeller failure are:

- running the engine with the water intake out of the water. Excessive heat will be produced by friction and the impeller will be burnt within seconds;
- manoeuvring in shallow water. If anything enters the pump with the water (sand, mud, small rocks, etc.), the impeller blades can be damaged. Short exposures will not result in immediate damage. Repeated exposures, however, will significantly reduce the life expectancy of the impeller. Salt crystals (for engines running in salt water) may also form and damage the impeller;
- starting the engine at sub-zero temperatures. The water present in the water pump may freeze under some circumstances. Starting the engine when the water in the water pump is frozen solid will result in immediate damage to the impeller;
- any obstruction of the intake inlet. Kelp, salt crystals, sand and small rocks can obstruct the intake inlet and prevent the water from entering the impeller.

A telltale on the side of the engine indicates whether the water pump is working properly. However, this is not the only exit point. Only a small fraction of the cooling water comes out of the engine by this telltale. The telltale may get obstructed, so it may be necessary to use a pin or a wire to remove the obstruction. Note that if the telltale is obstructed, it does not necessarily mean that the engine is not cooled properly. Remember that there are other exit points. If water is not coming out of the engine by the telltale, always investigate to determine the cause of the problem.

4.2.4.7 Engine alarms

Most engines have alarms that warn the operator when something is wrong. Usually, two alarms are present: one is to warn of a problem with the oil (usually low level) and the other warns the user that the engine is overheating. Usually, the oil alarm consists of rapidly repeating beeps, while the excessive heat alarm is a continuous beep. The alarm will beep briefly as the engine starts to tell you that the engine is active and functioning.

The oil alarm is activated by a sensor attached to the cap of the oil tank located on the engine. The sensor has a floater that will trigger the alarm when it reaches a certain point. It is important to understand that this sensor will be activated only for problems occurring between the primary or secondary tank. Any problem occurring between the secondary tank and the engine (e.g., disconnected oil hose inside the engine) will not be picked up by this sensor. In that particular case, the secondary tank may be full (so the alarm will not ring) and the engine may not receive any oil.

The heat alarm is controlled by a temperature sensor. When the temperature gets to a certain level, the alarm will ring. Often, the information from the temperature sensor is relayed to a visual indicator located on the boat's instrument panel. Problems at the level of the engine cooling mechanism (damaged water pump or obstructed water intake) are the main cause of overheating. Running the engine at a speed just below what would be required to get a hull in the planing mode (planing hull only) can also cause the engine to overheat (especially on a hot, sunny day). This problem often occurs during towing.

Remember that the water pump is driven by the driveshaft. The effectiveness of the pump is thus proportional to the RPMs of the engine. Moving at high speed (planing mode) for a while may help the engine to cool down. The other option is to shut down the engine for a while. This may be less effective (and thus take more time) than the previous option since water is tremendously more effective than air for conducting heat.

4.2.5 Troubleshooting basic mechanical problems

4.2.5.1 Introduction

Troubleshooting for mechanical problems is typically the responsibility of the vessel's engineer, when he or she is part of your complement. In vessels that do not carry an engineer, crews should be able to provide basic help to themselves and those vessels that they are tasked to assist. Often, a simple mechanical fix can avoid a long tow or eliminate "down time" on your own vessel.

This section will discuss troubleshooting diesel engines, problems common to both gasoline and diesel engines, troubleshooting the outboard motor and troubleshooting steering gear failure.

4.2.5.2 Troubleshooting diesel engines

Diesel engines are very common power plants for larger vessels. They are extremely reliable when properly maintained. Typical problems, their possible causes, and potential solutions are outlined below.

Problem	Cause	Solution
Engine will not turn over when starter button is pushed	Main power switch off;	Turn main power switch on;
	Battery cables loose or corroded;	Tighten, clean, or replace cable, terminals;
	Starter motor cables loose or corroded;	Tighten, clean or replace cable;
	Batteries are low or dead;	Charge or replace batteries;
	Engine seized hydraulic lock (fuel or water in cylinders);	Remove injectors, bar engine over by hand (to relieve pressure and prevent internal damage);
	Misalignment of controls, neutral safety switches;	Make appropriate adjustment, realign controls;
Chattering solenoid switch.	Replace, repair cable; Replace solenoid. Check battery voltage.	

Problème	Cause	Solution
Irregular engine operation; (Engine runs unevenly or stalls.)	Strainers and fuel filter clogged;	Clean, replace and purge air (bleed);
	Lines and fittings leaking;	Check fuel lines and fittings for leaks. Tighten or replace;
	Insufficient fuel / aeration of fuel;	Sound tanks, shift suction, refuel if necessary;
	Binding fuel control linkages;	Inspect and adjust;
	Insufficient intake of air.	Inspect air intake for obstructions. Check emergency air shutdown for possible restrictions.
Engine overspeeds or overruns	If engine RPMs increase, an internal engine malfunction has occurred. A clutch that slipped into neutral, a lost propeller could be the cause. It is most important that the operator assess any problem promptly. When the engine overspeeds, always follow the procedures in the next column.	If an engine appears to be operating normally at cruising speed but fails to slow down as the throttle is being returned to neutral, do not place the throttle in neutral until it is determined that the engine is in fact out of control (i.e., check for detached throttle linkage). Keeping the engine in gear will prevent it from being destroyed. Secure the engine by following the steps below; Pull engine stops (kill switch); Shut down fuel supply; Stuff rags into the air intake.

Problème	Cause	Solution
Engine oil pressure high	Incorrect grade of oil;	Monitor pressure. If it becomes too high, secure engine;
	Oil filters dirty;	Change oil filters;
	Cold engine not up to operating temperature;	Warm up engine;
	Relief valve stuck;	Adjust, remove or clean;
	Worn or damaged engine parts.	Secure engine; Monitor, add oil, and secure engine if excessive consumption continues.
Engine surges	Air in fuel system;	Secure engine. Bleed air out of fuel system;
	Clogged fuel filters;	Switch / change fuel filters;
	Aeration of fuel (from heavy weather);	Shift to lower fuel suction;
	Governor instability;	Adjust: check free movement of fly weights;
	Loose throttle linkage.	Tighten linkage.
Reduction gear fails to engage	Loss of gear oil;	Add gear oil. Check and correct leaks;
	Strainer / filter clogged;	Clean strainer, change filter;
	Loose, broken, linkage out of adjustment.	Inspect and correct as necessary.
Unusual noise in reduction gear	Loss of gear oil;	Secure engine, check gear oil. Refill and resume operation for signs of leakage;
	Worn out / misalignment of reduction gear.	Secure engine.

Problème	Cause	Solution
Loss of gear oil pressure to reduction gear	Loss of gear oil.	Inspect all high-pressure lines for leaks and repair. If unable to repair, secure engine.
Temperature of engine coolant higher than normal	Thermostat faulty, expansion tank cap faulty, leaky hoses, etc.	Inspect all lines for leaks and repair.
Engine smokes: Black or gray smoke	Incomplete burning of fuel; Excessive fuel if irregular fuel distribution.	High exhaust backpressure or a restricted air inlet causes insufficient air for combustion and will result in incompletely burned fuel. High exhaust backpressure is caused by faulty exhaust piping or muffler obstruction; Replace faulty parts. Restricted airflow to the engine cylinders is caused by clogged cylinder liner ports or blower air inlet screens. Clean these items. Check the emergency stop to make sure that it is completely open and readjust as necessary; Check injector timing and the position of injector rack control levers. Time the fuel injectors and perform the appropriate governor tune-up.

Problème	Cause	Solution
Blue smoke	Improper grade of fuel	Drain tanks, change filters and upgrade fuel used;
	Lubricating oil being burned	Check for internal lube oil leaks;
	Bad oil seals in turbocharger	Conduct compression check; Check valve and rings.
White smoke	Misfiring cylinders	Check for faulty injectors and replace as necessary;
	Cold engine	Allow engine to warm up under a light load;
	Water in fuel	Drain filters/strainers. Drain fuel tanks.

4.2.5.3 Problems common to both gasoline and diesel engines

Diesel and gasoline engines run on different types of fuel and operate in different ways. However, there are common problems, causes and solutions that may apply to both.

Problem	Cause	Solution
Starter whines. Engine doesn't crank over, doesn't engage, starter relay may chatter.	Defective starter. Bendix is not engaged. Defective starter relay;	Return to dock. Replace or repair starter or relay. Check bendix;
	Low battery voltage.	Check battery cables for loose connection (or corro- sion) to starter. Charge or replace battery.
Engine fails to start when starter is turning over	Fuel shutoff closed;	Open fuel shutoff;
	Clogged air cleaner;	Clean air filter;
	Out of fuel;	Fill tanks, bleed and prime system;
	Clogged strainer;	Clean strainer, bleed system;
	Clogged / crimped fuel line;	Replace or repair fuel line;
	Inoperable fuel pump;	Replace;
	Emergency air shut-off blower tripped;	Reset;
	Clogged air intake;	Remove, clean and replace;
Low battery voltage causes slow cranking.	Charge battery or replace.	

Problème	Cause	Solution
Engine temperature high	Closed or partially closed sea suction valve;	Rubber impeller on raw water pump inoperable. Check raw water overboard discharge; if little or none, check sea suction valve;
<i>Note: For all high temperature situations, place the throttle immediately in neutral, then look for the probable cause. When an overheated engine must be shut down, turn the engine over periodically to prevent it from seizing.</i>	Clogged raw water strainer. (especially in shallow water);	Clean strainer;
	Broken raw water or cooling system hose;	Shut down engine, replace hose;
	Broken or loose raw water pump drive belt;	Shut down engine, replace or tighten belt;
	Expansion tank (cooling system) empty or low;	Handle the same as for a car radiator. Open with caution, releasing pressure before removing cap. With engine running, add coolant;
	Thermostat stuck, cooling system;	Secure engine, remove thermostat, add engine coolant;
	Water in lube oil;	Check lube oil for "milky" colour. If found, secure engine;
	Blown head gasket;	Secure engine, lock shaft;
	Engine overload (towing too big a vessel or towing too fast);	Reduce engine speed;
	Ice clogged sea suction (especially during operation in slush ice);	Shift to lower suctions, transit directly to open water;
Air bound sea chest.	Open / clear sea chest vent valve.	

Problème	Cause	Solution
Engine lube oil pressure fails	Lube oil level low;	If above red line, check oil and add more if needed. If below red line, secure engine;
	External oil leak;	Tighten fittings if possible. If not, secure engine;
	Lube oil dilution;	Secure engine if fuel dilution is over 5%;
	Lube oil gauge defective.	Take load off engine, if applicable. Check to confirm that gauge appears to be operating normally.
No oil pressure	Lube oil pump failure.	Secure engine. Repeat all procedures for previous item.
Loss of electrical power	Short circuit / loose connections causing tripped circuit breaker or blown fuse;	Check for shorts/grounds. Reset circuit breakers, replace fuses as necessary;
	Corroded wiring connections;	Clean or replace wiring;
	Overloaded circuit;	Secure all unnecessary circuits, reset circuit breakers, replace fuses as necessary;
	Dead battery.	Charge or replace battery.
Alternator indicator light on	Loose / broken belt;	Replace / tighten belt;
	Loose terminal connections;	Inspect and tighten;
	Defective alternator or governor.	Replace defective item.

Problème	Cause	Solution
Shaft vibrations	Damaged or fouled propeller;	Reduce speed and / or place throttles in neutral if possible;
	Bent shaft;	Reduce speed, check for hull damage or leaks;
	Engine or shaft out of alignment.	Slowly increase speed on engine. On twin engine boats, increase speed on one engine at a time to determine which shaft is vibrating. If vibration continues even at low speeds, secure the engine involved and lock the shaft.
Engine stops suddenly and will not turn through a full revolution		Check for an obstruction within a cylinder such as water or a broken, bent or shut valve.
Engine stops running when hot and won't turn over when cool		The engine has seized and must be overhauled.
Engine stops with a loud clatter.		Inspect for obvious damage. Damage may be to internal parts such as valves, valve springs, bearings, piston rings, etc. Overhaul of the engine is required.
Engine oil level rises, oil looks and feels gummy		There may be coolant leaking into the engine oil. Check for internal leakage. Repair the engine before continuing operations.

Problème	Cause	Solution
Engine oil level rises and feels thin		Fuel is leaking into the crankcase. Check fuel pump. After the problem has been corrected, change oil and filters.
Hot water in bilges		Inspect the exhaust piping and/or coolant water level. Coolant is probably leaking into the bilge. Check all hoses.
Engine runs with a thumping or knocking noise		There is most likely internal damage and the engine will have to be overhauled.

4.2.5.4 Outboard motor troubleshooting

Outboard motors are very common and are extensively used on both Canadian Coast Guard and Canadian Coast Guard Auxiliary resources. The owner's manual for your outboard will provide guidance for specific maintenance, but typical problems, their possible causes, and potential solutions are outlined in checklists below.

Problem	Probable Cause / Correction
Engine won't start	Fuel tank empty; Fuel tank vent closed; Fuel line improperly connected or damaged; check both ends; Fuel system not primed; Engine flooded, look for fuel overflow; Clogged fuel filter or line; Spark plug wires reversed; Loose battery connections; Cracked or fouled spark plug; Fuel pump not primed.

Problem	Probable Cause / Correction
Starter motor won't work (electric start)	Gear shift not in neutral; Defective starter switch.
Loss of power	Too much oil in fuel mix; Fuel / air mixture too lean (backfiring); Fuel hose kinked; Slight block in fuel line or fuel filter; Propeller is fouled; Water in fuel; Spark plug fouled; Magneto or distributor points fouled.
Engine misfires	Spark plug damaged; Spark plug loose; Faulty coil or condenser; Incorrect spark plug; Choke needs adjusting; Improper fuel and oil mixture; Dirty carburetor filter; Distributor cap cracked.
Overheating	Cooling intake fouled; Too little oil; Water pump impeller worn; Defective water pump; Towing too big a vessel or towing too fast.
Blue smoke	Spark plugs fouled by too much oil.
Engine surges	Outboard motor not properly mounted – propeller rides out of the water; Carburetor requires adjustment.

Problem	Probable Cause / Correction
Poor boat performance	Wrong propeller; Engine tilted too high; Bent propeller – usually accompanied by a high level of vibration; Boat is overloaded; Heavy marine growth on boat bottom; Cavitation.

4.2.5.5 Troubleshooting steering gear failure

A steering gear failure may have a simple solution or require outside assistance. If the boat has two propellers, this type of failure may also test your boat handling skills. General advice is as follows:

Problem	Probable Cause / Correction
Broken or jammed steering cable	Rig emergency steering as applicable and return to the dock.
Broken hydraulic line or hydraulic system failure	Inspect hoses for leaks, check fluid level, and add fluid if necessary; Replace hose if spare is carried on board; Rig emergency steering as applicable; Steer with engines if twin propeller; Try to centre rudder amidships; Anchor if necessary.
“Frozen,” damaged or blocked rudder, outdrive or outboard	Attempt to free if possible; Centre rudder if possible and block in place.

4.3 SAR EQUIPMENT

The following specifications should be considered when buying SAR equipment:

4.3.1 Binoculars

- 7x50s Marine are most appropriate for use on small boats;
- must be designed for boating and SAR applications;
- waterproof, shockproof, armoured (rubber covered);
- eyepiece covers, carrying straps and carrying case.

4.3.2 Night vision goggles

- designed for boating and SAR applications;
- waterproof and buoyant;
- weather resistant (humidity and moisture);
- over-light protected;
- able to withstand temperature extremes and vibrations;
- optics protected with eye-guards and front lids, which allow daytime observation through lid pinholes;
- yellow colour;
- lightweight;
- neck strap;
- handheld or adjustable headmount;
- hard yellow waterproof carrying case and instruction manual;
- tested to military specifications;
- generation III+ technology;
- 40° field of view.

4.3.3 Searchlight

- designed for patrol craft;
- designed to be hand-held (portable);
- capable of effectively illuminating a light-coloured object at night ;
- must have 18 m (59 ft.) scope at a distance of 180 m (590 ft.) and operational reliability of at least 3 continuous hours;
- battery powered, rechargeable battery, quick charger/power supply;
- reliable and resistant to long periods of inactivity;
- optional detachable amber filter and covert infrared filter;
- focus knob (provides back-up for focus motor failure);
- powerful enough to illuminate objects 0.5 mile downrange;
- watertight;
- weatherproof and anticorrosive;
- light weight;
- yellow colour;
- large yellow storage case.

4.3.4 Flashlight

- watertight;
- unbreakable body;
- yellow colour;
- powered by long-life alkaline batteries;
- set of spare batteries and spare bulb.

4.3.5 Life buoys

- stowed so they can be quickly thrown overboard in an emergency
- orange colour
- Transport Canada approval
- outside diameter of 610 mm (24 in.) or 762 mm (30 in.)
- attached to a buoyant line not less than 15 m (49 ft.) in length

Note: In Canada, horseshoes do not meet the life buoy requirement.

4.3.6 Throw-bags

- yellow rope not less than 15 m (49 ft.);
- buoyant rope made from material like polypropylene makes an excellent buoyant heaving line;
- a loop at the end and weighted floating handle make it easy to cleat and throw (no metal piece);
- some have a flexible flotation collar with a floating retrieval line for lifting a person on board;
- weatherproof storage bag.

4.3.7 Rescue extension

- reach pole extension (1.8 m/6 ft.) or telescoping extension pole (2.4 m/8 ft.);
- light weight device;
- good tensile strength;
- equipped with a floating rescue hoop.

4.3.8 Fire extinguishers

- dry chemical extinguishers are recommended, Class BC or ABC;
- marine type is highly recommended because of resistance to corrosion;
- Class ABC is designed for all kinds of fires on small vessels;
- must be approved by Transport Canada, ULC (Underwriters' Laboratories of Canada) or United States Coast Guard (for marine use).

4.3.9 Rescue frame

- allows retrieval of casualties from water with life-saving speed, ease and safety;
- parbuckle design;
- quickly and easily deployed;
- retrieval by a single rescuer, with little effort;
- conscious overboard casualties can easily climb the outside of the loop like a ladder;

- injured or unconscious casualties can be floated into the loop and quickly lifted horizontally to safety;
- some avoid further injury by not crushing the casualty;
- easy and compact storage, does not require repacking;
- highly durable, maintenance free;
- unlimited usage in training;
- CCG or USCG approved.

4.3.10 SAR pumps

- portable;
- gasoline-powered;
- easily passed from one boat to another in a watertight container in moderate to heavy seas;
- saltwater resistant.

4.4 TRAILERING A BOAT

4.4.1 General

Since much more damage can be done to the boat by the stresses of road travel than by search and rescue response in heavy weather, choosing the proper trailer is essential. The following section will provide information on choosing a trailer, safe trailering on the road, and procedures for launching the boat.

4.4.2 Trailer capacity

The capacity of the boat trailer must be greater than the combined weight of the boat, engines, fuel, basic boat equipment and any rescue equipment that may be carried in the boat during trailering.

The size and weight of the boat may require that the tow vehicle be specially equipped with:

- sufficiently powered engine;
- transmission designed for towing;
- larger cooling systems for both the engines and the transmission;
- heavy duty brakes; and
- load bearing hitch.

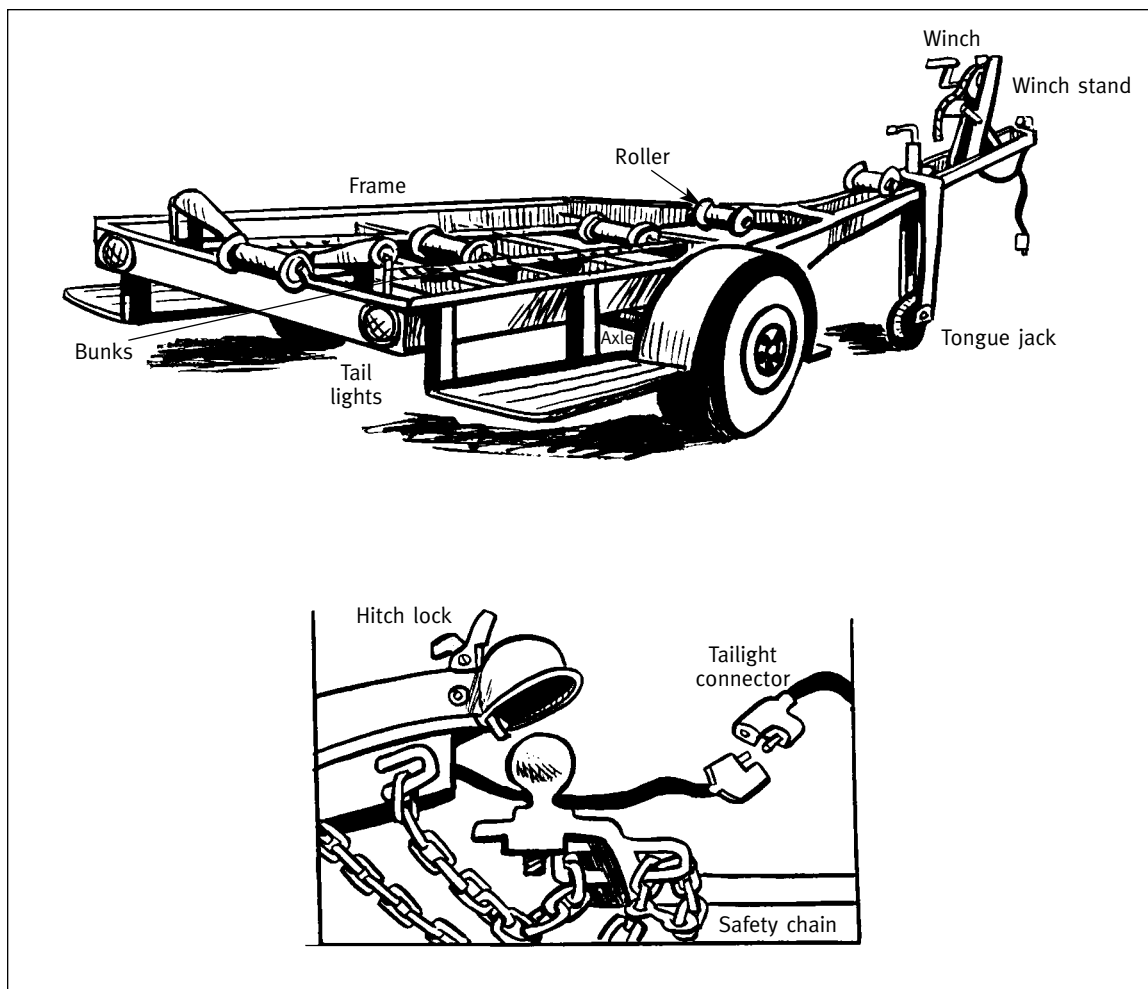

Figure 4.6: Parts of a trailer

4.4.3 Balancing and securing the boat

The structural support provided to the boat during trailering must be spread as evenly as possible across the hull. This allows for even weight distribution of the hull, engines and equipment. The trailer must be long enough to support the whole length of the hull, but short enough to allow the lower unit of the engines to extend freely.

Keep rollers and/or bunks in good condition to prevent scratching and gouging of the hull. Properly adjust tie-downs and lower-unit supports (if fitted) to prevent the boat from bouncing on the trailer.

The boat's bow eye should be secured with a chain in addition to a winch cable. It is also a good practice to secure the boat to the trailer by means of a beam-securing strap.

4.4.4 Pre-departure checklist

- Ensure that all trailer bolts are tightly secured. Otherwise, the vibration of road travel may loosen them;
- The tow ball and actuator must be the same size. The actuator must be completely over the ball, and the latching mechanism must be locked in place;
- Ensure that the trailer is loaded evenly from front to rear as well as from side to side. Too much weight on the hitch (tongue weight) will cause the rear wheels of the tow vehicle to drag and make steering more difficult. Too much weight on the rear of the trailer will cause the trailer to “fishtail” and could reduce traction or even lift the rear wheels of the tow vehicle off the ground;
- Equipment must be properly secured with the weight evenly distributed;
- Attach the trailer safety chains in a crisscross pattern, under the actuator, to the hitch assembly of the tow vehicle. In this way, if the ball were to break, the trailer would move in a straight line, preventing the actuator from dragging on the road;
- Ensure that the trailer lights and turn signals are functioning properly;
- Check brakes. To determine a safe stopping distance, roll forward on a level parking area and apply the brakes several times, at increasing speeds each time;
- Side-view mirrors must be large enough to provide an unobstructed rear view from both sides of the vehicle;
- Check your tires – including the spare – and the wheel bearings. Improper inflation may cause steering difficulty. In addition, wheels that are too small or of lower quality could cause problems. Trailer wheel bearings should be inspected and greased after immersion in water – especially saltwater;
- Make sure that excess water from rain or cleaning is removed from the boat. Water weighs approximately 1 kg per litre (1 gallon=10 pounds) and will add weight that shifts as the trailer moves;
- Carry a spare tire for the trailer and ensure that it is in good condition and inflated to the proper operating pressure;
- Ensure that the vehicle and trailer jacks are in good working order; and
- Ensure that you have proper vehicle insurance coverage for trailering a boat.

4.4.5 As you trailer

As you are towing the boat, keep the following precautions in mind:

- If you are new to trailering, practice turning, backing up and manoeuvring in a level, open parking area;
- Allow more time to brake, accelerate, pass and stop;
- Remember that your turning radius is much greater with a boat trailer behind you. Give curbs and roadside barriers a wide berth when negotiating corners.

4.4.6 Launching the boat

- Park away from the boat launch and inspect the ramp for obstructions, slipperiness and drop-offs;
- Disconnect the trailer lights from the tow vehicle to ensure that you do not damage the trailer electrical system;
- Ensure that the boat drain plug (if fitted) is in place;

- Raise the lower unit or stern drive to ensure that it will not strike bottom during launching;
- Back slowly into the water. Get some help when you back down the ramp. An extra pair of eyes behind you can prevent accidents. When backing, put your hand on the bottom of the steering wheel and use your mirrors. Then, all you have to do is move your hand in the direction that you want the trailer to go in. A good guideline is to back the trailer into the water until the front of the fender is at water level. Keeping the rear wheel of the tow vehicle out of the water will generally keep exhaust pipes out of the water. If exhaust pipes become immersed in the water, the engine may stall. On very flat ramps you usually need to back in further; on steep ramps, not so far. The type of boat could also make a big difference. Set your parking brake. If the ramp is steep, you may need to block the front wheels of the vehicle. PUT ON YOUR PFD. Have someone on shore hold the lines attached to the boat. Release the winch. Lower the motor and prepare to start the engine(s) (after running blowers and checking for fuel leaks). Start the engine(s) and make sure that water is going through the engine cooling system(s). Gently push the boat off the trailer or, if necessary, back off slowly using the engines dead slow astern.

4.4.7 Recovering the boat

- Secure the boat near the ramp and back the trailer into the water. Set the parking brake and block the front wheels;
- Manoeuvre the boat carefully to the submerged trailer. Shut down the engine/s, raise the lower unit and attach the winch cable to the boat's bow trailering eye;
- Winch the boat onto the trailer;
- Pull the boat from the ramp;
- Store and lash equipment and set the engine(s) for trailering. Pull any drains, secure all tie-down straps, hook up the trailer lights and test them; and,
- If possible, flush the engine(s) with fresh water after each use.

4.4.8 Trailer maintenance

Most trailers generally require very little maintenance. The following guidelines are recommended in addition to the manufacturer's maintenance guide:

- Always conduct a "walk around" and visually inspect the trailer before each trip;
- Monitor tire pressure before each trip. Improper tire inflation can result in increased tire wear, poor handling, heat buildup and possible tire blowout. Never mix radial tires with bias ply tires;
- Always ensure that the surge brake actuator is filled to the proper level with the recommended brake fluid;
- Keep all moving parts well lubricated as per the manufacturer's recommendations;
- Always rinse the trailer with fresh water, especially if the boat has been launched in salt water. If you frequently use the boat in salt water, the trailer should be fitted with a brake flushing kit. See your dealer for details;

- DO NOT OVER-LUBRICATE WHEEL BEARINGS. It is a common fault for individuals to grease “bearing buddies” to the point that grease escapes from the vent holes. This can displace inner bearing seals and damage the wheel bearings. Follow the manufacturer’s recommendations CAREFULLY!;
- If you are stowing your trailer for a period of time, remove weight from the wheels of the trailer by blocking the tongue and all four corners of the frame.

4.4.9 You and the law

The Highway Traffic Act of your province or territory may have specific requirements for the trailering of boats (i.e., driver certification, electric brakes or maximum trailering widths).

Check with your local law enforcement agency to determine the rules and regulations for your area of operations.

4.5 ON BOARD EMERGENCIES

Prudent crews consider the possibility of any emergency, and have a plan for dealing with it. Good coxswains drill their crews in procedures to be followed under various emergency situations.

4.5.1 Person overboard

The nature of the search and rescue task exposes crewmembers to a high risk of involuntarily entering the water. A person-overboard situation is one of the most serious occurrences aboard a vessel engaged in SAR. Every second counts, particularly in difficult or cold weather. Every crewmember must know the following procedures thoroughly. Even more important than knowing the procedures is training. Every crewmember must be able to carry out these procedures with instantaneous precision. The only way this level of skill can be achieved is by training and practice. Your life may depend on it.

4.5.1.1 Recovery procedure

The first crewmember to realize that someone has gone overboard calls out “PERSON IN WATER (PIW)” and, if possible, indicates on which side of the boat the person went over. For example, if a person fell over the port side, the crew member would call “PERSON IN WATER, PORT SIDE!” In the case of a witnessed person-overboard situation, this crewmember keeps the person in the water in sight continuously, both while calling out the alarm and until rescue is achieved.

Throwing a flotation device

Throw a ring buoy with strobe light if available (or anything that floats) over the side towards the person in the water. It does not matter if the person is visible at this time or not. The person in the water may see the flotation device and be able to get to it. Additionally, any floating object thrown over the side serves as a reference point marking the general location of the incident and for manoeuvring the boat during the search.

Do not throw the floatable object(s) at the person overboard. It could cause further injury if it hits the individual. Throw the object so that it or its line can drift down to the person while avoiding fouling the line in the propeller.

While maintaining visual contact with the person in the water, the crewmember calling the person-overboard alarm takes up station as the pointer. He or she continually points to the person in the water and takes whatever position is required in order to maintain visual contact.

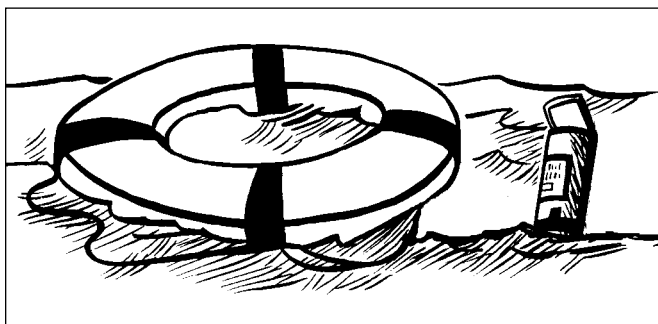

Figure 4.7: Life buoy with strobe

If the person in the water is not in sight, mark datum physically with a datum marker buoy (DMB) or electronically by activating the memory function on the long-range navigation (Loran-C) or the global positioning system (GPS). On vessels with a pilothouse-mounted loran, the memory mark datum function is carried out by the helmsman. On vessels with the loran mounted below, this function is carried out by a second crewmember.

Once the “person overboard” alarm is given, the helmsman conducts an appropriate person-overboard manoeuvre. Either the Anderson (or one turn) or Williamson manoeuvre is recommended. While the manoeuvre is taking place, a crewmember will cast a life ring over the side that was indicated in the alarm.

At this point, the guidelines for the recovery of a person in the water (PIW) should be applied. Refer to chapter 11 for more details.

Basic approaches

The coxswain must select an approach that is suitable for the prevailing conditions.

There are two basic approaches:

- leeward approach (against the wind and current)
- windward approach (with the wind and current).

Perform the leeward approach with the bow facing into the greatest force of oncoming resistance at the time of pickup.

Perform the windward approach with the wind coming from behind the boat. Use the windward approach when the person overboard is in a confined space or a leeward approach is impossible.

4.5.1.2 Anderson (one-turn) manoeuvre

The Anderson manoeuvre is faster than the Williamson, but it requires a skillful master and a highly manoeuvrable vessel. This method works best on small units such as RHIBs or Fast Rescue Craft (FRCs). To perform this manoeuvre, follow these steps:

- Put the rudder over full towards the person (e.g., if the person fell over the starboard side, put the rudder over full to starboard). Stop the engines;
- When clear of the person, go ahead full using full rudder;
- When about two thirds of the way around, back the engines two thirds or full. Stop the engines when the person is 15° of the bow. Ease the rudder and back the engine as required;
- Bring the vessel upwind or downwind of the person, stop the vessel in the water with the person alongside, well forward of the propellers.

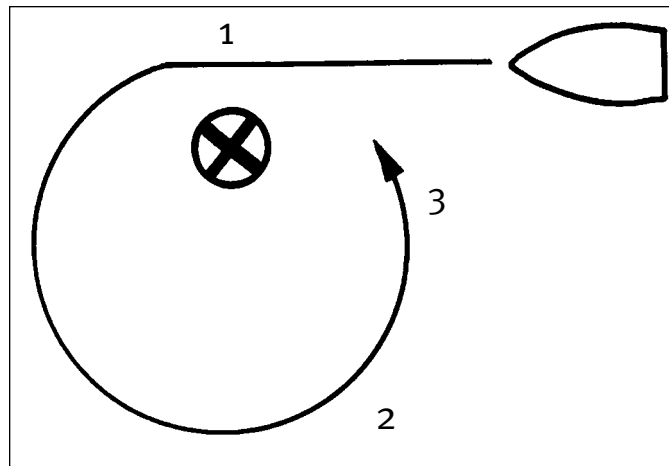

Figure 4.8: The Anderson Turn

Note: Many variations of this method are possible, to suit the characteristics of the vessel and sea conditions.

4.5.1.3 Williamson manoeuvre

The Williamson turn is slower but easier to perform. It is recommended if there is danger of losing sight of the person in the water, or for large single screw displacement hull types of vessels.

To perform a Williamson manoeuvre, follow these steps:

- Put the rudder over full in the same direction as the person in the water;
- When clear of the person, go ahead full using full rudder;
- When the heading is about 60 degrees beyond the original course, immediately shift the rudder to full over in the opposite direction (60 degrees is appropriate for many vessels, but the exact amount must be determined through trial and error);
- Bring the vessel upwind or downwind of the person, stop the vessel in the water with the person alongside, well forward of the propellers.

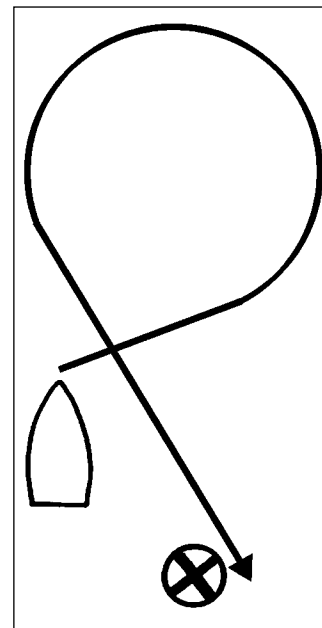

Figure 4.9: The Williamson Turn

Note: These procedures must be practiced on a regular basis. Every member of the SAR crew must practice each routine. The coxswain cannot always be in charge. He or she may be the person in the water.

4.5.2 Accidental grounding

4.5.2.1 General

The nature of search and rescue work can expose vessels engaged in SAR to a high risk of grounding. SAR vessels can work in the worst of situations with few tools and no backup. There is no room for error. The prudent navigator plots a safe passage through all situations. However, should you have the unfortunate experience of running your SAR vessel aground, your day is already ruined. Why not try to salvage what is left of it by following a few simple steps?

If an SAR vessel does run aground, the coxswain must evaluate the situation immediately and take the following steps to secure the situation:

1. Shut down the engines without delay to prevent engine damage caused by drawing sand or other matter into the cooling-system intakes;
2. Conduct a head check of the crew to be sure everyone stayed aboard and is uninjured;
3. Inform RCC/MRSC of the situation immediately so that assistance, if required, can be tasked;
4. **DO NOT TRY TO BACK OFF IMMEDIATELY! EVALUATE THE SITUATION FIRST!** If the bottom is soft matter, an attempt to back off could direct more material forward with the propeller wash, depositing more material around the hull and putting the vessel harder aground;
5. Keep the RCC informed of the situation and your intentions;
6. Deploy anchors to seaward to prevent being forced further aground;
7. Inspect the bilge spaces to determine whether there is any leakage from hull damage, and if so secure the damage;
8. Determine the amount of water, if any, in the bilges, and take steps to remove it;
9. Determine the extent of hull damage;
10. Take soundings around the entire vessel to determine the depth of water and the characteristics of the bottom. Decide whether backing off would be expedient or cause further damage. You must also consider whether your pumps could control flooding if you were to back off;
11. If it is safe to do so, stay with your vessel until you are refloated or other assistance arrives.

4.5.2.2 Accidental-grounding checklist

- stop engines;
- head check / injuries;
- don PFD if you are not already wearing one;
- inform RCC/MRSC of situation and maintain communication;
- do not back off before evaluating;
- set anchors to seaward if possible;
- inspect bilges for water;
- check for leaks;
- check for damage to hull;
- sound around the vessel;
- determine the effects of backing off, including the capability of pumps;
- stay aboard until assistance arrives or you are refloated;
- determine if pollution control is needed;
- since groundings often occur in adverse conditions, always keep the survival equipment prepared.

4.5.3 Emergency procedure in the event of capsizing

4.5.3.1 General

The key to surviving a capsizing is to avoid it ever happening. If it cannot be avoided, then the crew must recognize when it could happen and be prepared. The heavy weather section of the boat-handling chapter discusses situations and conditions that can lead to capsizing. This chapter also presents warning signs of risk and measures for minimizing it. The coxswain must continually assess conditions to ensure the safety of the boat crew and of those in distress; however, all crew members are responsible for keeping the coxswain advised if the situation changes.

4.5.3.2 Prevention

A boat is less likely to capsize in deep, open water. The chances of capsizing are greatest during operations in or near the surf or breaking seas. The force needed to capsize is most likely to come from heavy seas directly astern (following seas), or large breakers striking abeam. Stay at sea until conditions change. The safest point for most boats to take heavy seas is nearly bow-on. Do not operate or tow in conditions beyond the capability of the boat or crew. In such conditions, advise RCC/MRSC so that the proper resource can respond. Conditions present in many capsizings include:

- surf or breaking seas;
- shallow water depth (less than 20 ft.);
- going against a strong tidal current with steep following seas;
- escorting or towing another boat through an inlet;
- restricted visibility due to darkness, rain, or fog;
- stability reduced by low fuel in the tank, excessive amounts of water in bilges, icing of topsides, or too many people on board.

4.5.3.3 Precautions

If the hull is intact after capsizing, it will not sink for some time, even in rough seas. The crew will have time to escape if panic is avoided. Precautions to be taken ahead of time include:

- Learn the boat's interior. Initially the crew will be disoriented due to being upside down with inadequate lighting;
- Stow all loose gear and have all equipment and doors operating properly for ease in escaping;
- Know the location and use of all survival equipment. Check it regularly to be sure that it is appropriate and in good repair, and that all signaling devices work;
- Be ready to grab a sturdy support to prevent being thrown about.

4.5.3.4 Escape procedures

- If trapped in or under the boat, seek out an air pocket near the top (inverted bottom). Gather the crew together in the air pocket. Take time to have everyone settle down and focus on planning a safe escape. Discuss the escape route and objects of reference along the route. Look down; light may be visible and escape immediate;
- Make every effort to escape. The boat may sink, or the air will eventually escape through hull fittings, cracks, or holes, or become unfit to breathe (fuel vapors, bilge waste, or lack of oxygen due to survivors breathing);
- Before attempting to escape, check for needed survival equipment, especially flotation and signaling devices;
- PFDs may have to be removed temporarily for people to fit through spaces or to go underwater to reach an exit. If necessary, tie a line to the PFD and pull it out after exiting;
- Avoid the stern if the engines are still running;
- If caught in an open cockpit area, swim down below the gunwales and surface alongside the boat.

Escape from an enclosed compartment will require additional planning. Advice includes:

- All exits are upside down when the boat capsizes. Locate an exit route and reference points from the compartment to open water;
- PFDs may have to be removed temporarily for people to fit through spaces or to go underwater to reach an exit. If necessary, tie a line to the PFD and pull it out after exiting;
- Swim underwater through the exit and out from the boat. If a line is available, the best swimmer should exit first through a cabin door or window, carrying the line. If no line is available, have the best swimmer go first, followed by a poorer swimmer and lastly a good swimmer. (If the poorer swimmers are left alone inside, they are likely to panic and not escape.) The first swimmer, when free, should tap on the hull to signal success in getting out;
- Cold water decreases the length of time anyone can hold their breath underwater. Immersion in cold water may also give a sensation of tightness in the chest. Experiment inside the compartment before attempting to escape. This will decrease the possibility of panic during the escape attempt.

4.5.3.5 Alongside a capsized boat

Survivors from a capsized boat should attempt to stay with the boat or other visible floating debris.

- Get on board a life raft if available;
- If a life raft is not available, climb onto the boat, if possible. Otherwise, hold onto the largest floating object available;
- Generally, everyone should stay with the boat and not swim for shore. Distances to the beach can be deceiving, and strenuous activities such as swimming in cold water can hasten the onset of hypothermia.

Survivors should consider tying themselves to the boat if there is a rapid means of untying or cutting free, in case the boat shifts or sinks. Most people are likely to become tired or develop hypothermia.

4.5.3.6 Remaining inside a capsized boat

If someone cannot exit the capsized boat:

- Remain calm and stay within an air pocket;
- Trap the air in the compartments (e.g., close any hull valves that can be located);
- When rescuers are heard, attempt to communicate to them by shouting or tapping on the hull;
- Conserve oxygen by remaining calm and minimizing physical activity. If possible, get out of the water to reduce hypothermia;
- Remember that rescuers should arrive soon.

4.5.3.7 Self-righting techniques for an RHIB

The stability of rigid hull inflatable boats (RHIBs) in rough seas can be a mixed blessing. Crews operating such boats will probably have a tendency to go out in rougher seas than crews operating other kinds of boats. Although this is desirable in terms of SAR capabilities and coverage, it can increase the risk of capsizing. Since capsizing is a life-threatening situation, SAR crews operating RHIBs should have a standard procedure to cover such an event. The following pages will describe such a procedure.

Self-righting system standard procedure

Usually the self-righting system is designed to operate manually, not automatically. When the system is triggered, the righting movement is fairly quick.

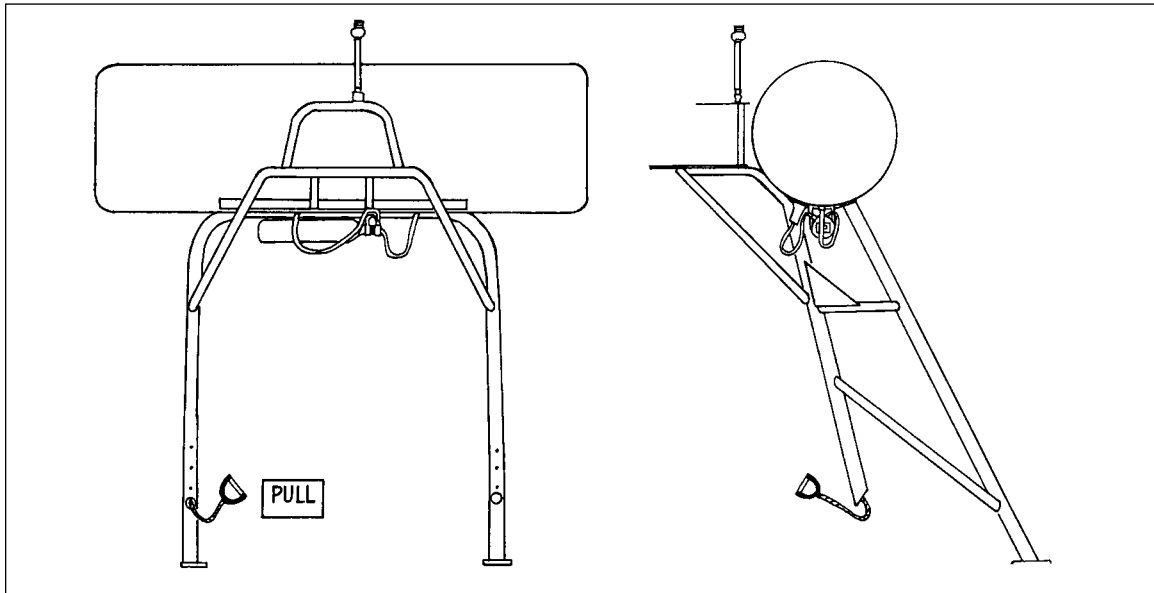

Figure 4.10: Self-righting system assembly (733 system shown)

WARNING

The self-righting system cannot be triggered with the maintenance safety pin still in the firing head.

The sequence of events is as follows:

- Check crew for injuries and numbers.
- All crew to assemble at the transom. Try to stay on the downwind side of the boat, so the boat will drift towards you and not away from you.

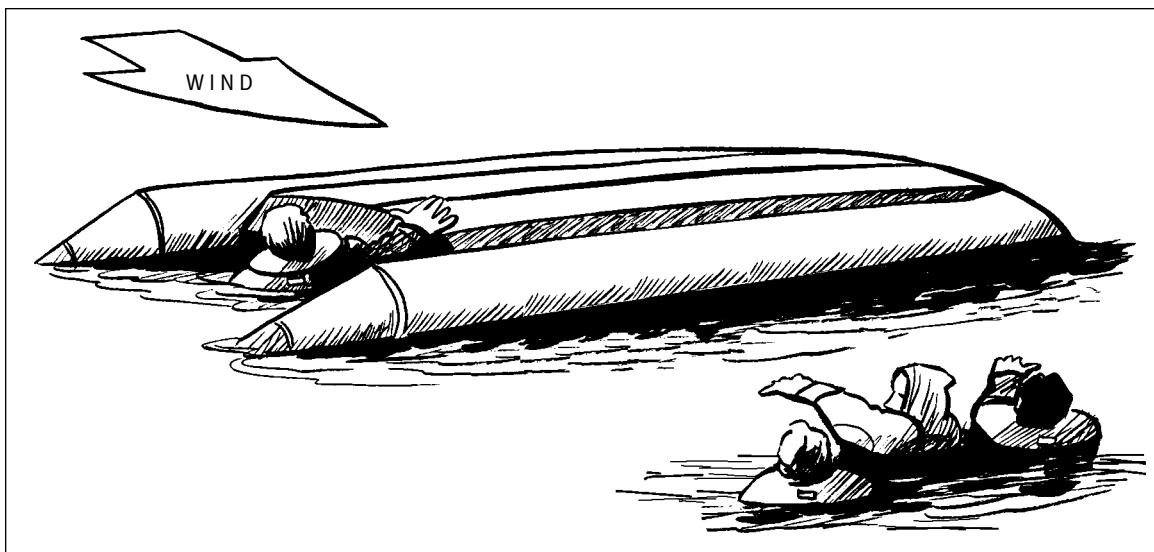

Figure 4.11: Typical crew positioning

- First of all, deploy the safety line and swim it out until the line is taut. The rest of the crew will assist in this process while the coxswain stays at the transom.
- Once the crew have the safety line out, the coxswain can now activate the self-righting system by pulling firmly on the handle. As soon as the system is activated, the coxswain will swim/pull himself or herself down the safety line. The time from pulling the handle to a completely righted position is about 28 seconds. This time will vary slightly from boat to boat. Caution should be taken to ensure that all personnel are clear of the craft prior to activating the self-righting system. The crew should position themselves downwind from the craft (once the boat is righted, the bag will cause the craft to sail).
- Once the boat has righted itself, all crew members should grab onto the boat as quickly as possible. The crew can then begin boarding the boat. Access to the righted boat can be gained by using the engine leg as a step. Then, the first person on board helps the others into the boat.

Once the crew is on board:

- DO NOT DEFLATE THE RIGHTING BAG. If conditions were bad enough to cause your vessel to capsize, it may very well capsize again. If you deflate the bag, you will not be able to prevent further capsizing. If the risk of capsizing no longer exists, the bag may be deflated;
- Check your crew for numbers and injuries;
- Try your radio and send a MAYDAY;
- If no contact, deploy the EPIRB;
- Deploy the sea anchor and recover the safety line;
- Remember that you do have flares, but USE THEM WISELY;
- The engines will probably have water in the cylinders. The method of removing the water is to remove the spark plugs and turn over the engine until the water is ALL gone. Replace the plugs, prime the fuel system, and try to start the engines. This process should be attempted only if conditions permit.

Note: The engines will have water in the carburetors and cylinders (from the exhaust system), so you have to turn over the engines for about 10-20 seconds. Water will spray out of the spark plug holes. Once the engine turns over without water spraying out, pump the FUEL priming bulb to prime the carburetors. DO NOT prime the OIL system. If the starter is unserviceable, then use the pull start method, remembering to activate the primer and turn on the key when it comes time to start the engine.

Theory of capsizing an RHIB

Capsizing of an RHIB will occur in a variety of circumstances:

- breaking waves taken on the beam or head on with no power applied;
- when heading into excessive winds, the RHIB may be blown over backwards if operated improperly;
- if the RHIB is travelling down the face of a wave, the risk of capsizing is there as the forward part of the tube may dig into the wave and decelerate, allowing the stem to pass the bow, resulting in a pitch pole;
- during towing operations.

Breaking waves

If a breaking wave is taken on the beam, the RHIB will lay on its side, causing it to ride on the tube. There is a good chance that the RHIB may not capsize. It will just surf on the tube. But, the RHIB does stand a chance of capsizing. If the RHIB is laying head into the sea with little or no power on, and it is hit with a large wave that is breaking, there is a good chance that the RHIB will be pushed backwards down the wave and the stem will stop once it bottoms out on the wave. This will cause the bow to pass the stem, causing a capsize. This style of capsize is very real and dangerous, as it is very violent.

Operating in excessive winds

If the RHIB is being operated in excessive winds, there is a good chance that the RHIB will be blown over (depending on how it is loaded and on the style of RHIB). The solution to this is to quarter the waves and wind. If a capsize does result, there is a good possibility of being thrown clear.

RHIB travelling down the face of a wave

When the RHIB travels down the face of a large wave and the forward portion of the tube digs in and decelerates the bow, allowing the stem to pass the bow, a pitch-pole style of capsize is the usual result. When this happens, the bow will usually shear off, catching more water and slowing down the bow even more.

Towing

Towing operations can sometimes cause a rescue unit to capsize. The height of the towing post above the deck can be a contributing factor in this case. If the towing post is high above the deck, the leverage effect on the hull will be significant. Keeping the towline in a fore and aft alignment reduces the risk of capsizing. When the rescue and the towed vessel are in motion, avoid having the towline come abreast of the rescue unit. This is especially true during towing in adverse sea conditions. Other safety considerations such as the snapping of the towline are discussed in Chapter 10.

4.5.4 Injury to a crewmember

The nature of SAR work predisposes crewmembers to injury. Most injuries can be prevented by using safe working practices and the available personal protection equipment. Unfortunately, even the most prudent crewmember may be injured. In that event, follow these guidelines:

- have the crewmember with the best first aid skills assess the injury;
- advise RCC/MRSC of the injury through the MCTS and request medical assistance if deemed appropriate;
- give necessary first aid treatment using the best advice available, obtained through the MCTS if necessary;
- take the patient to the base or to a rendezvous with an ambulance or doctor by the most appropriate route;
- complete the relevant paperwork as soon as possible.

4.5.5 Becoming disoriented

Given that vessels engaged in SAR must often perform their duties when other vessels have failed, the risk of being out in adverse conditions (night, fog, bad weather...) is very much present. Under those circumstances, even the most experienced crews may become disoriented and lose their fix. If this occurs, follow these guidelines:

- Don't compound the problem by letting your ego take over;
- Confer with the rest of the crew. Maybe someone knows where you are;
- Try to get a fix by using all available resources;
- Advise RCC/MRSC of your predicament and give them your last known position (they will dispatch a vessel to DF and find you if necessary);
- MCTS has surveillance radars and VHF DF equipment, and may be able to help you.

4.5.6 Fire on board

Use the following procedures when battling a fire that breaks out on your boat. When a crewmember becomes aware of an engine compartment fire:

- Shut off all engines, generators, and ventilation systems;
- If boat is equipped with an automatic extinguishing system, ensure it is discharging. If the system is manually operated, energize it and check to ensure it is discharging;
- Initiate a mayday call to alert boats in the area of the situation;
- Have all crew members don PFDs and move to a smoke-free and flame-free area of the boat;
- If a life raft or dinghy is available, put it over the side and inflate it, if necessary;

WARNING
 CO₂ is extremely cold and can burn or raise blisters. Keep your hands on the insulated horn handle when using a cylinder.

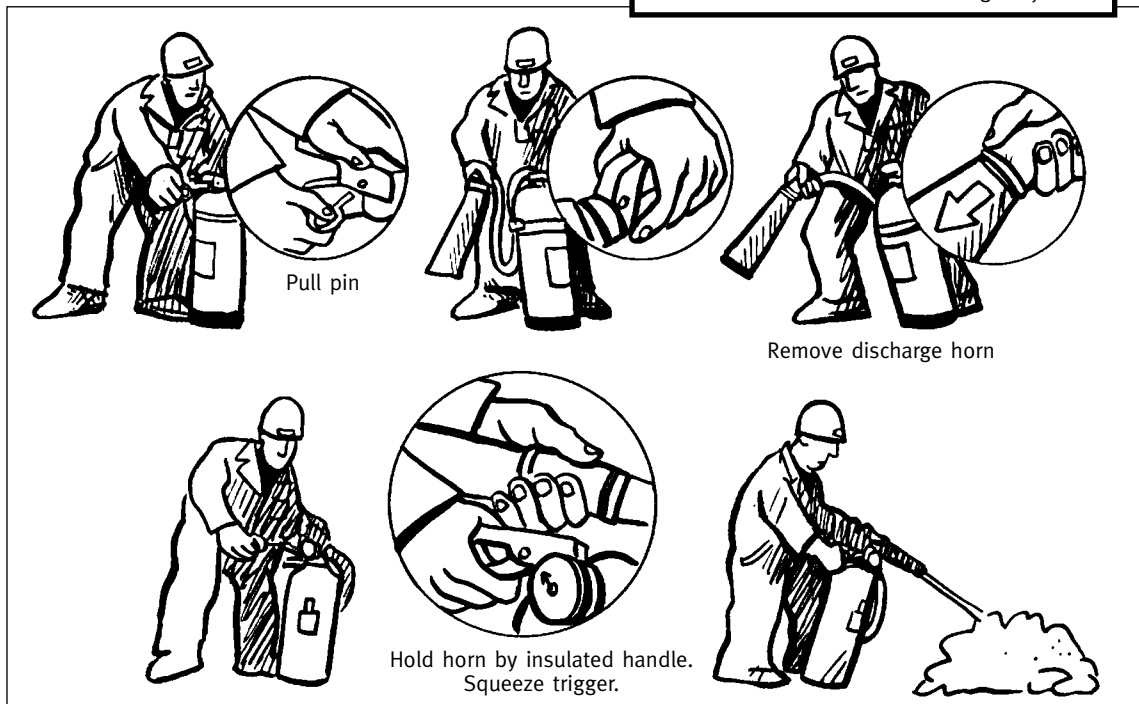

Figure 4.12: Operating the CO₂ extinguisher

- If boat has a built-in CO₂ system, allow time for concentrations of CO₂ to dissipate after fire is out before entering the compartment. On boats fitted with a Halon system, the danger of toxic gases is not as great when entering the compartment, but always enter with caution.

4.5.6.1 Opening a hatch

If someone must open a hatch to discharge a portable extinguisher, expect the possibility of burned hands and/or a singed face. As the fresh air enters the compartment, it will feed the fire, and cause it to “blow up.” The best method of opening a hatch is to stand to the hinged side of the hatch. Then, wearing gloves or using something other than bare hands, pull the hatch open. If the boat has a closed engine compartment and no fixed system, it is a good idea to make a small hole with a pivoted cover into the space. A portable extinguisher may be discharged through this hole.

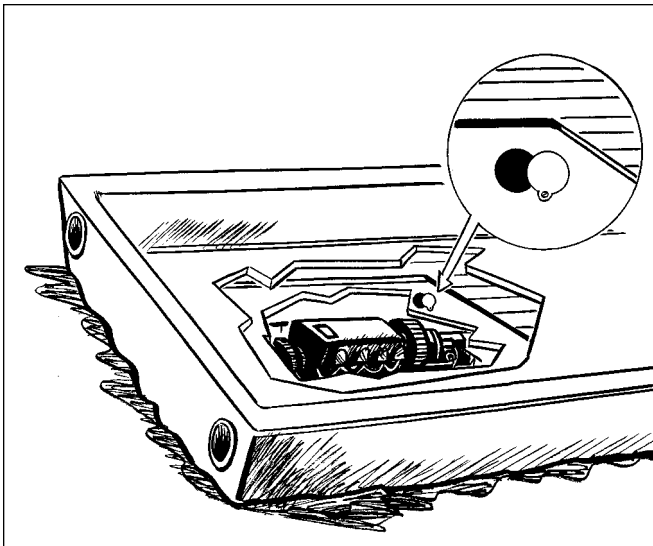

Figure 4.13: Hole for extinguishing the engine compartment

CHAPTER 5 – SEAMANSHIP AND TERMINOLOGY

5.1	Boat terminology	5-5
5.1.1	General	5-5
5.1.2	Location, position and direction aboard a boat	5-5
5.1.3	Construction terminology	5-6
5.1.4	Boat measurement	5-6
5.1.5	Construction parts	5-6
5.1.6	Deck fittings	5-9
5.2	Types of boats	5-11
5.2.1	Sailboats	5-11
5.2.1.1	Types of sailboat	5-11
5.2.1.2	The basic small sailboat	5-12
5.2.2	Small motorboats	5-14
5.2.2.1	The Runabout	5-15
5.2.2.2	Freshwater and saltwater fishing boats (boats for anglers)	5-16
5.2.2.3	Cruisers, trawlers, and houseboats	5-18
5.2.2.4	Pontoon and deck-type boats	5-19
5.2.2.5	Personal watercraft	5-19
5.2.2.6	Inflatable boats	5-20
5.2.2.7	Canoes, kayaks, and rowboats	5-21
5.2.3	Fishing vessels	5-22
5.2.3.1	Side trawler	5-22
5.2.3.2	Stern trawler	5-22
5.2.3.3	Outrigger trawler or beam trawler	5-22
5.2.3.4	Tuna purse seiner	5-22
5.2.3.5	Purse seiner	5-22
5.2.3.6	Dredger	5-23
5.2.3.7	Lift-netter	5-23
5.2.3.8	Pot vessel	5-23
5.2.3.9	Longliner	5-23
5.2.3.10	Tuna longliner	5-24
5.2.3.11	Pole-and-line vessel	5-24
5.2.3.12	Troller	5-24
5.2.3.13	Pump fishing vessel	5-24
5.2.3.14	Trawler-purse seiner	5-25
5.3	Boat motions	5-25

5.4	Ropes	5-25
5.4.1	Types and characteristics of ropes	5-25
5.4.1.1	Twisted vs. braided ropes	5-25
5.4.2	Natural fibre rope	5-26
5.4.2.1	Sisal	5-26
5.4.2.2	Hemp	5-27
5.4.2.3	Manila	5-27
5.4.3	Synthetic fibre ropes	5-28
5.4.3.1	Nylon	5-28
5.4.3.2	Polyesters	5-29
5.4.3.3	Polypropylene	5-29
5.5	Knots, bends, hitches and related items	5-30
5.5.1	General	5-30
5.5.2	Knots	5-30
5.5.2.1	Bowline	5-30
5.5.2.2	Square Knot	5-30
5.5.2.3	Figure-eight knot	5-30
5.5.3	Bends	5-30
5.5.3.1	Sheet bend	5-31
5.5.3.2	Fisherman's bend	5-31
5.5.4	Hitches	5-31
5.5.4.1	Half hitch	5-31
5.5.4.2	Timber hitch	5-31
5.5.4.3	Clove Hitch	5-31
5.5.5	Whipping	5-34
5.5.6	Splicing	5-35
5.5.6.1	Short splice	5-35
5.5.6.2	Long splice	5-35
5.5.6.3	Eye splice	5-35
5.5.7	Using ropes with deck fittings	5-36
5.5.7.1	Securing a line to a standard cleat	5-36
5.5.7.2	Securing a line to a Sampson post	5-37
5.5.7.3	Securing a line to a bitt	5-37
5.5.7.4	Securing a line to a railing	5-37

5.6	Wire Rope	5-38
5.6.1	Construction	5-38
5.6.2	Wire rope lay	5-39
5.6.3	Safety considerations	5-39
5.6.3.1	Safe working loads	5-39
5.6.3.2	Bending stress	5-40
5.6.3.3	Inspection	5-42
5.7	Working with ropes, lines and wires	5-43
5.7.1	Working with ropes	5-44
5.7.1.1	Rope inspection	5-44
5.7.1.2	Coiling and faking a rope	5-45
5.7.1.3	Cutting a rope	5-45
5.7.1.4	Safe working loads	5-46
5.7.2	Working with wires	5-47
5.7.2.1	Taking a rope from a reel	5-47
5.7.2.2	Storage	5-47
5.7.2.3	Seizing and cutting	5-48
5.7.2.4	Accidents involving use of mooring wires and reels	5-48
5.7.2.5	Working safely	5-49

5 SEAMANSHIP AND TERMINOLOGY

5.1 BOAT TERMINOLOGY

5.1.1 General

Let's begin with some information for making boat-related terminology a little easier to understand. Knowing and using correct nautical terminology is important to give an impression of professionalism to people you are trying to help. It is also important because, as a member of a SAR crew, you need to express yourself clearly to avoid confusion.

5.1.2 Location, position and direction aboard a boat

The front end of a boat is called the **bow**. You are going **forward** if you are moving toward the bow. Your boat is going ahead when it is moving in the direction of the bow. When you are looking at the bow, the right front side is called the **starboard bow**, and the left front side is called the **port bow**.

The central, or middle, area of a boat is **amidships**. The right centre-side is the **starboard beam** while the left centre-side is the **port beam**. The **beam** is the point where the width of a vessel is at its maximum. If an object is **abeam**, it is directly (at a 90° angle) on the side of your boat, since there are no two points where your boat width is maximal.

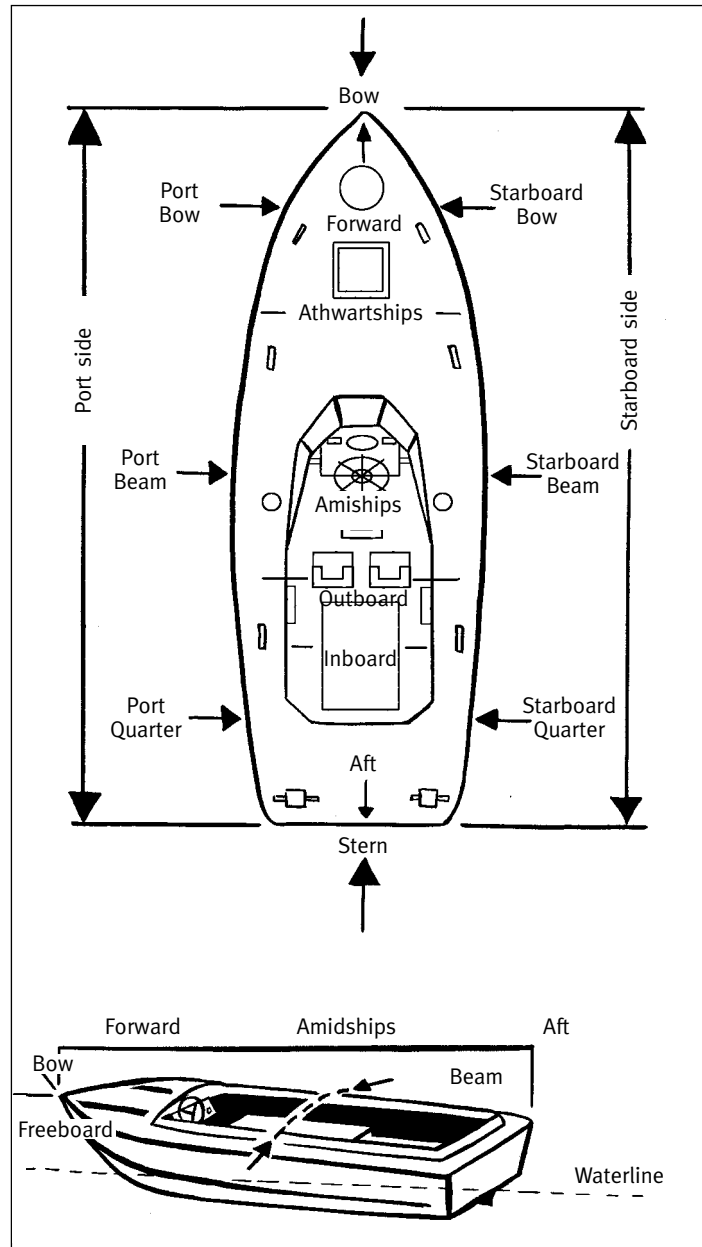

Figure 5.1: The various locations, positions and directions aboard a boat

The extreme rear of a boat is the **stern**. If you are moving toward the stern, you are **going aft**. If your boat is moving in the direction of the stern, you are **going astern** or **making sternway**. When you are looking at the bow, the right rear section of the boat is called the **starboard quarter**, and the left rear section is called the **port quarter**.

As you have probably guessed by now, the entire **right side**, when you are looking at the bow, is the **starboard side**, while the **left side** is the **port side**.

A line, or anything else running parallel to the longitudinal centreline of the boat is said to lie **fore-and-aft**. If it runs from the centreline to either the port or starboard side, it is said to lie **athwartships**. From the centreline of the boat towards either port or starboard side is **outboard** while from either side toward the centreline is **inboard**.

5.1.3 Construction terminology

The hull is the main body of a boat. It consists of a structural framework and a skin that can be made of many different materials. The most common skin materials today are wood, metal and fibreglass. Innovation is ever-present in boat building. Space-age experimental materials are commonly being introduced into hull skin design to improve resistance to impact and abrasion.

There are three different kinds of hulls: displacement, planing and semi-displacement hulls. The various characteristics of these three different kinds of hulls will be detailed in the “Boat Handling” chapter.

5.1.4 Boat measurement

The **overall length** (also referred to as the length overall, or LOA) is the distance from the foremost to the aftermost points of the boat’s hull. The length of the plane where the surface of the water touches the hull when the boat is normally loaded is the **waterline length**.

Beam refers to the distance from the outside of the hull on one side of the boat to the outside of the hull on the opposite side of the boat at the widest part of the hull. **Breadth** refers to the distance from the outside of a frame on one side of the boat to the outside of the same numbered frame on the opposite side of the boat.

Freeboard is the vertical distance from the water surface to the top of the gunwale. **Draft** is the vertical distance from the water surface to the lowest point of the vessel. This point may be part of the vessel or its propulsion equipment. Depth is an internal measurement in the hull of a boat used in the documentation process. This term should not be confused with draft.

5.1.5 Construction parts

The keel is literally the backbone of the boat. It runs longitudinally, fore-and-aft along the centre bottom of the boat. Attached to the keel are frames that extend athwartships (from side to side). The **skin** of the boat is attached to these **frames**. Together, the **keel** and the

frames give the hull rigidity and strength to resist external forces and distribute the weight of the vessel and load over a large area.

The **stem** is a forward extension of the keel at the bow end, rising from the keel upward to the gunwale to form the anchoring point for the side planking or skin.

The forward end of the boat is the **bow**. The shape of the bow, its profile, form, and construction have much to do with hull resistance created as the boat moves through the water.

Flare is the outward curvature of the sides near the bow. Flare adds buoyancy to the bow, helps make for a “drier” boat and provides for more deck space forward.

The **chine** is a line where the bottom and the sides of a boat meet. One may refer to a “hard” chine or a “soft” chine. A boat has a hard chine when the bottom meets the side in a well-defined angle. A soft chine occurs where the bottom and side flow into one another in a continuous curve.

Frames give strength to a boat, and are referred to as **transverse** or **longitudinal**. If the keel is the backbone of a hull, the **transverse frames** are the ribs. They are commonly referred to as “ribs.” **Transverse frames** extend athwartships from (normal to) the keel and at specified distances apart. They may vary in size from bow to stern to support loads. Frames give a boat its distinctive shape. They are usually numbered from bow to stern. The **longitudinal frames** provide strength in the fore-and-aft direction, parallel to the keel. The top longitudinal frames provide the structure upon which the **deck** is formed.

A **deck** is a “sea-going floor.” A deck also provides strength to the **transverse frames** and **deck beams** to which it is attached. The **top deck** of a boat is called the **weather deck** because it is exposed to the elements and is watertight. Decks also have two characteristics: **sheer** and **camber**. Decks may exhibit different sheer lines when viewed from **abeam**. Some sheer lines dip from the bow to midships in a shallow curve. Others rise from bow to midships and many decks sheer in a straight line angling from bow to stern. The sheer helps shed water from the weather deck and is often used to simply add style and beauty to a boat’s lines. Camber is a rounded athwartships curve of the deck with its low points at the sides where the weather deck meets the sides of the boat. Water that runs down the sheer angle is deflected to the sides by the camber and is spilled overside through a piping system called **freeing ports** or **scuppers**.

If decks are seagoing floors, then **hatches** are seagoing doors in decks. Weather deck **hatches** and **doors** become watertight when installed in a raised framework called a **coaming**.

The **transom** is a solid flat member that forms the stern of the boat. It is mounted athwartships in a more or less vertical plane according to the design of the boat.

The **gunwale** is the upper part of the **sheer strake**, or the edge formed by the joining of the sides and the deck.

The **helm** is the boat's steering apparatus, usually a **tiller** or a **wheel**. See the section on sailboats.

5.1.6 Deck fittings

Basic deck hardware is, for the most part, associated with the need to fasten lines (ropes), or to control line length and/or tension. Each piece of hardware is developed to serve a specific purpose and should be used only for that purpose. To do otherwise could cause a piece to fail, often with tragic results. Some pieces of hardware specific to sailboats have been left out of this section: they will be dealt with in the section on sailboats.

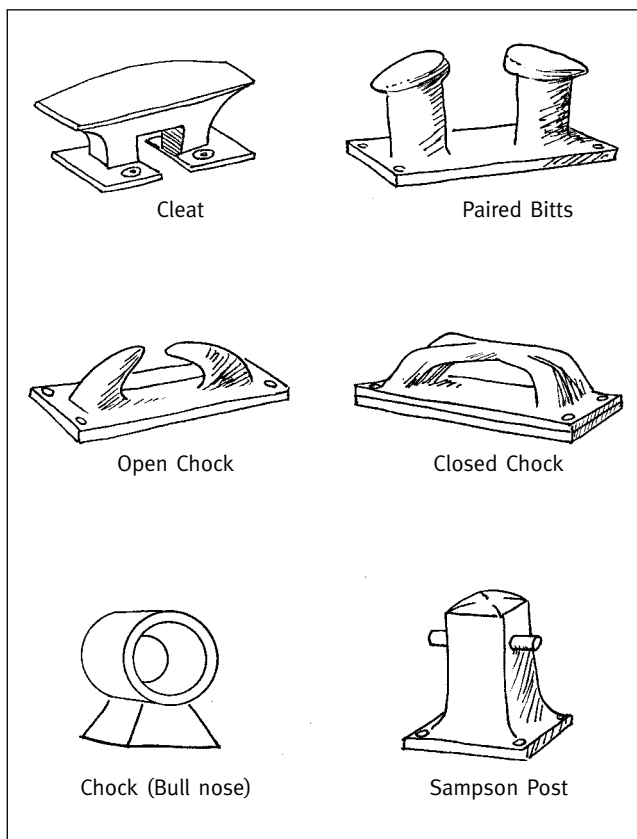

Figure 5.2: Types of deck fittings

Cleats are devices for securing lines without the use of knots, thus allowing for rapid release of the line when necessary. There are three commonly used cleats on small vessels: **standard**, **mooring** and **jam**.

Bitts may be of single or double post configuration. Most common on small craft is the single post bitt with a pair of cruciform horns which generally point athwartships. Bitts have their major application in securing heavy loads such as towlines. Vessels designed specifically for SAR often have dedicated towbitts.

A bollard is a vertical piece of timber or iron to which a vessel may be moored. Although it is not usually a deck fitting, a bollard can often be seen on a pier or dock.

Chocks are used to guide mooring lines and to protect the deck from damage by heavy loads such as anchor flukes.

Like a chock, a **fairlead** is used to guide a line. Usually, a line will go through a fairlead, but simply lie in a chock.

The **pulpit** is a raised railing at the bow or stern (push pit) designed to prevent crew from falling overboard.

Shackles are used to join lines, cables or wires. Shackles should always be **moused** to prevent the pin from working loose.

Hooks can be used for a variety of joining purposes. For example, safety harnesses are usually equipped with a hook on the end of the lanyard.

A **lifeline** is a line run around the weather deck which provides either a handhold or a place on which to snap one's safety harness hook in heavy weather.

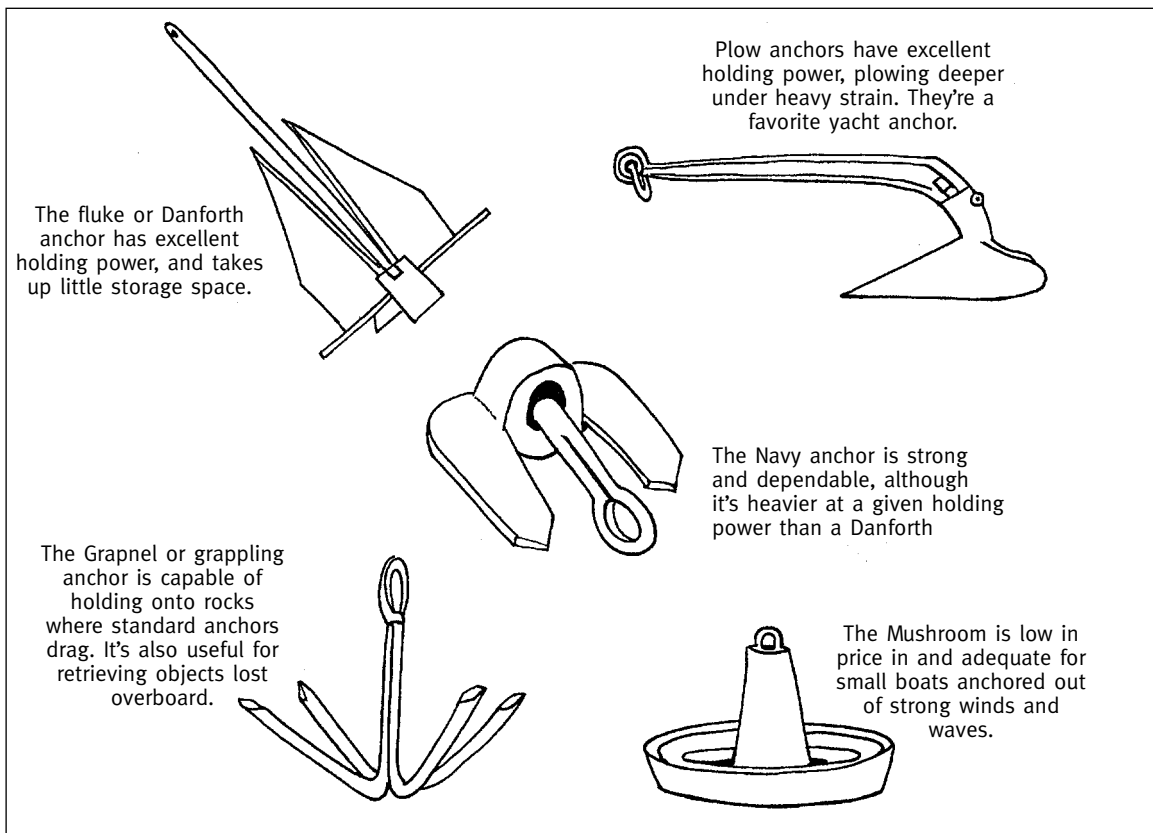

Figure 5.3: Various kind of anchors

An **anchor** is a device which is lowered to the sea bottom to secure the boat to the bottom and prevent it from drifting from its position. Anchors are designed in many shapes for use in many kinds of seabeds. Some of the common types of anchor are Danforth, Navy, Plow, Bruce, Fisherman's and Mushroom. The use of anchors is detailed in the boat handling chapter. . The line joining the anchor to the boat is referred to as the **rode**.

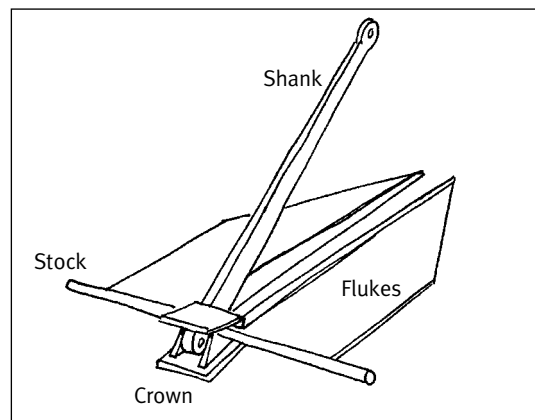

Figure 5.4: Main parts of a Danforth anchor

A type of **chain** used in anchoring with an internal cross bar in each link is called cable. Chain or cable is often used in small vessels between the anchor and a rope rode to improve the holding power of the anchor.

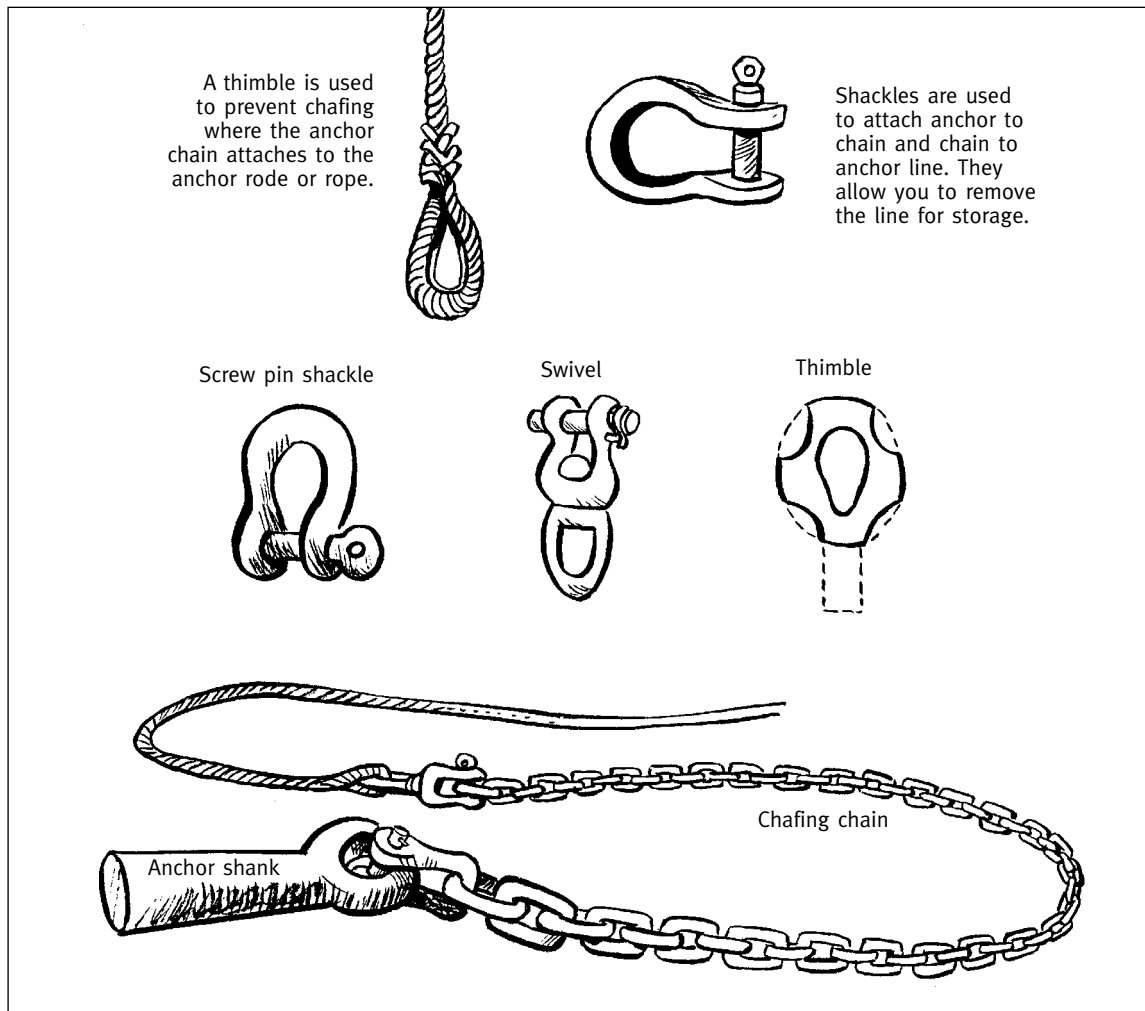

Figure 5.5: Anchor fittings

5.2 TYPES OF BOATS

Boats can be broadly classified into "power" and "sail" according to their forms of propulsion. In addition, there are many divisions within the classes.

5.2.1 Sailboats

Motorboats and sailboats have many similarities in construction and in terminology used for location, position and direction when aboard. Many of the fittings are common to both types of boat and will present no difficulties to the novice who is acquainted with one or the other type of boat. Sailboats, however, do have many performance characteristics that are unique to them and that require specialized fittings to perform properly.

All sailboats other than catamarans (which ride on the surface of the water) have displacement hulls. They ride through the water. Their designed shape is such that they will slip through the water much more easily for the same applied effort than most motorboats. Sailboats also carry greater draft than motorboats in that they require a keel or centreboard, below the hull, to resist leeway created by the force of the wind in the sails.

5.2.1.1 Types of sailboat

There are many types of sailboats. In a rescue operation, it will be helpful to know the silhouette characteristics of several types of sailboats in order to guide the search.

The **sloop** has a single mast and boom. Sloops carry a triangular mainsail and a single triangular foresail.

The **cutter** has a single mast and boom further aft than in a sloop. Cutters carry a triangular mainsail and are rigged for two triangular foresails.

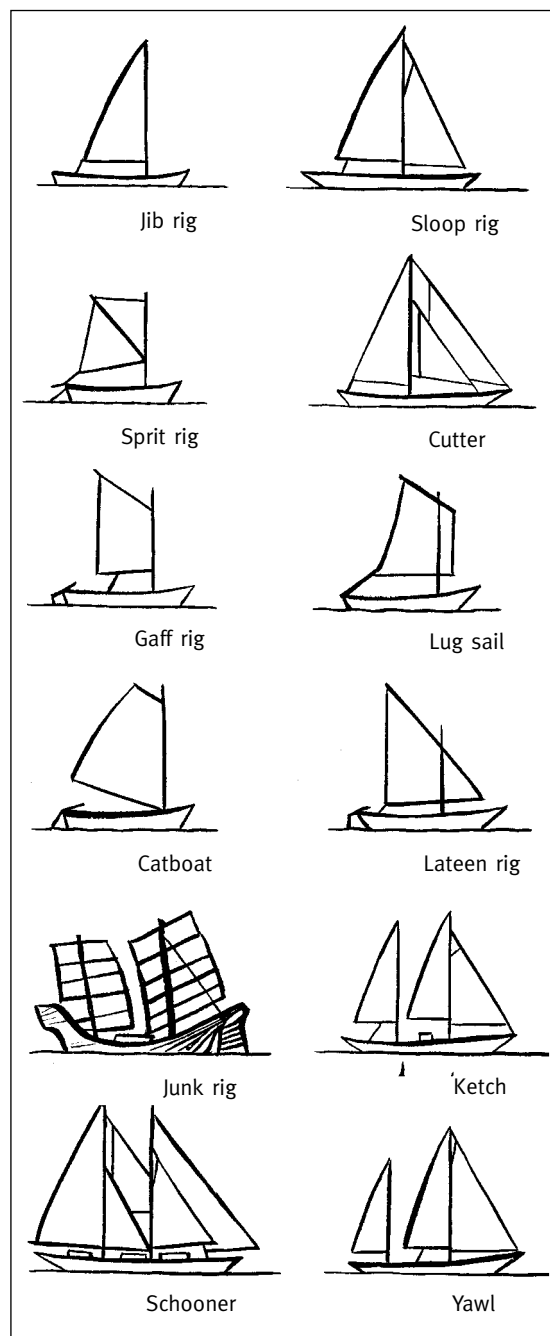

Figure 5.6: Silhouettes of sailboats

The **catboat** has a single mast stepped right forward with no forestay or shrouds. There is no boom, but a “wishbone” contains the loose-footed single sail.

The **ketch** is similar to the yawl except that the shorter mast is forward of the rudder post and the boat is rigged for two foresails.

Schooners are fore-and-aft rigged just as all of the above sailboats. They have two or more masts. In the two-masted kind, the foremast is shorter than the aft or mainmast. A gaff supports the head of the sail on the foremast and there may be multiple foresails.

The **yawl** carries two masts with booms. The higher mast is forward; the shorter mast is aft of the rudderpost and is called the mizzenmast. Yawls are rigged for one foresail. All sails are triangular.

Catamarans have two parallel hulls joined by a truss or solid deck and may be sloop rigged.

Trimarans have three parallel hulls. The centre hull is larger than the two outboard hulls. Trimarans may be sloop rigged.

5.2.1.2 The basic small sailboat

Figure 5.7 illustrates the components of a typical basic small sailboat. Larger boats will carry a greater number and different layout of the basic items to support the operation of a larger vessel. Sailboats may also be fitted with auxiliary motor power.

Sailboat fittings may be grouped into three main categories: **standing rigging**, **running rigging** and **deck fittings**.

Standing rigging consists of fixed lines or wire cables attached to the mast(s) to support the mast(s) against the powerful forces acting upon them. **Shrouds** provide lateral support to the mast(s). A **spreader** may be mounted athwartships near the top of the mast, in which case there will be at least two shrouds on each side of the mast. The **cap shrouds** are the **upper shrouds** and run from the deck over the outboard ends of the spreaders to the top of the mast. The **lower shrouds** run from the deck to a point on the mast just below the spreaders. If there are two lower shrouds, they are called respectively **lower fore-shroud** and **lower aft-shroud**. The **forestay** supports the mast(s) in the fore and aft direction. It is a line running from the stem to the top of the mast and is also used to support the **foresail**. The **backstay** also supports the mast(s) in the fore and aft direction, but it runs from a point on the transom to the top of the mast.

The **running rigging** is made up of lines and associated sheaves and blocks through which the lines may run. Any line that is used for hoisting sails or yards or flags is called a **halyard**. On a fore-and-aft rigged sailing vessel, the outer end of the boom is held in position and raised or lowered by the **topping lift**. Lines used to adjust the set of sails are called **sheets**. The sheets take their name from the particular sail they service. Thus: **headsail sheet**, **main sheet**, and **spinnaker sheet**. Under certain sailing conditions, the boom

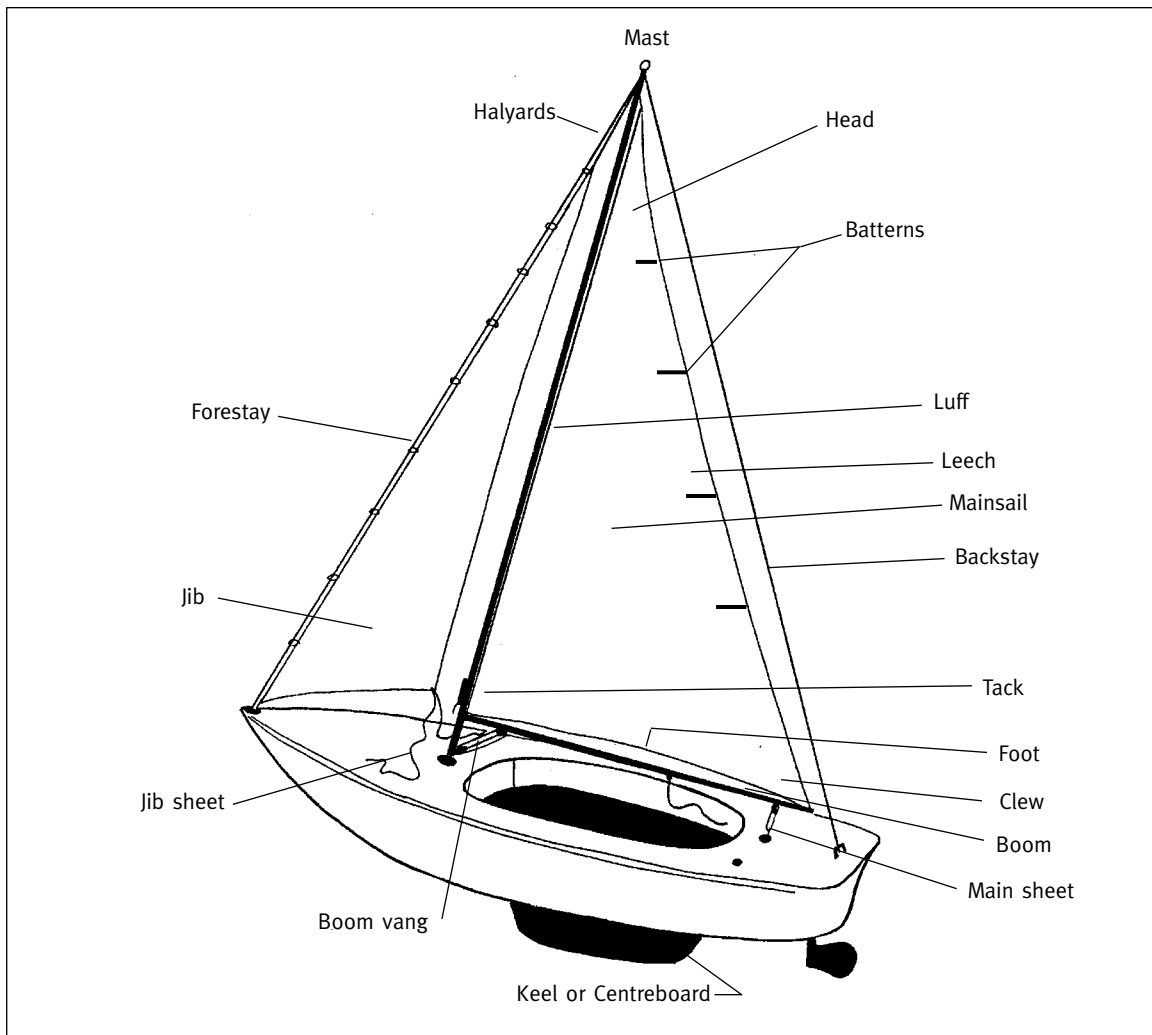

Figure 5.7: A typical small sailboat

tends to rise due to the force of the wind on the sail. A set of tackle from the boom to the foot of the mast, called the **boom vang**, is used to keep the boom from rising.

Sailing craft have several **deck fittings** that are not found on motorboats. Shrouds must be anchored very securely. At the point where the shrouds meet the deck, very substantial anchor points, called **chainplates**, are provided. These are often metal plates with holes in them to receive **turnbuckles** or **shackles**. The stern rail of a sailboat is often called the **pushpit**. In order to manage the strain on various sheets and halyards with a minimum of effort, different sized **winches** provide the sailor with mechanical advantage, **Halyard** winches may be mounted on the mast to handle the task of hoisting the mainsail and fore-sail(s). **Sheet winches** are usually mounted on deck in pairs, (one for port tack and one for starboard tack), to handle the trimming of headsails. The base of the mast is mounted in the **stepping shoe** or **stepping post**. The stepping shoe may be seated in the keel or mounted on deck or on a cabin top depending on the size of the vessel. The **tiller** is a handle attached to the top of the rudder and extending forward into the cockpit or steering position. The tiller provides a manual lever for turning the rudder and thus controlling the

direction of the boat. Some boats, usually larger ones, replace the tiller with a **wheel** and interconnecting cables or hydraulics to the rudder. Even in these situations, there is a lever arm or small tiller on top of the rudderpost.

5.2.2 Small motorboats

Powerboats sizes range from diminutive 2.5 m (8 ft.) powered by 1-horse electric motors to stately 45 m (148 ft.) driven by multiple diesels with thousands of horsepower.

They can be classified as outboards or inboards.

- Outboard:** a self-contained engine and propulsion system that mounts on the stern. Most are two-cycle and burn oil along with gasoline to create power.
- Inboard:** a four-cycle gas or diesel engine mounted amidships, which drives the boat through a shaft in the bottom.

They can be broken into many subclasses, including:

- Runabouts, ski boats and performance boats;
- Fishing boats;
- Live-aboards: cruisers, trawlers and houseboats;
- Pontoon and deck boats;
- Personal watercraft (PWCs);
- Inflatable boats.

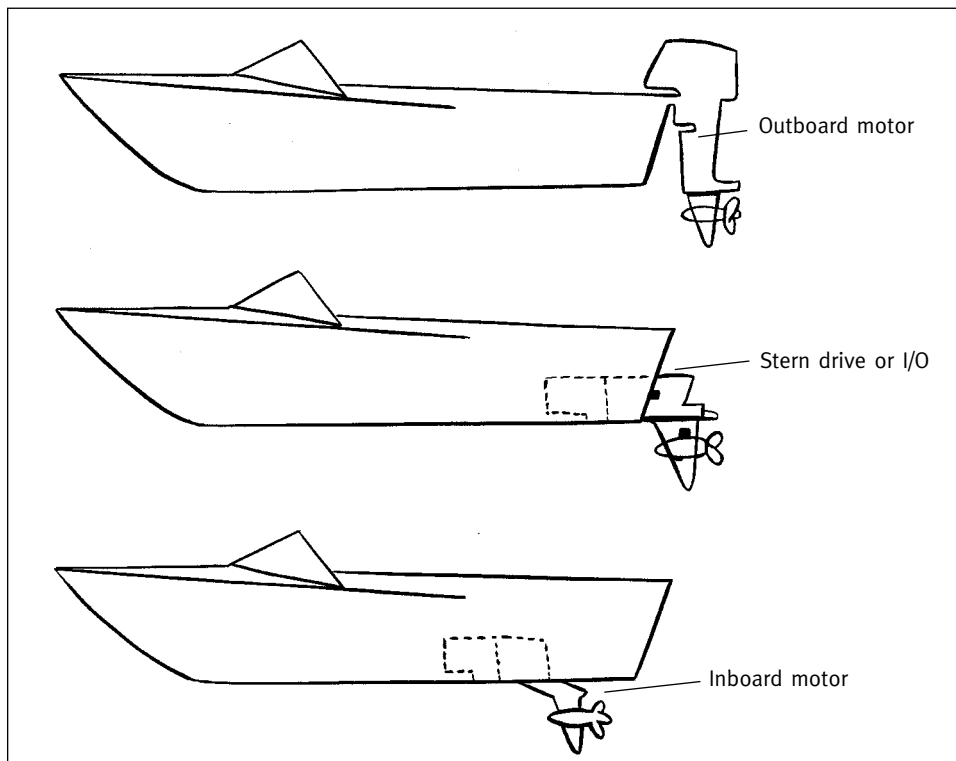

Figure 5.8: Terms to describe small motorboats

5.2.2.1 The Runabout

This is the one-model-fits-all family boat. It has a closed bow, a windshield, back-to-back seats that fold down into a sun lounge, and space to store water skis and life jackets under the sole or main deck. The runabout offer versatility and comfort. The Bow-rider is a variation of the runabout. It has the same hull and aft layout, but with seats replacing the closed bow and a walk-through door in the windshield to allow passage forward. There is more seating space – enough for six or eight passengers, depending on the depth and beam of the boat. There is a large cockpit aft.

Dedicated ski boats are a specialized form of runabout. They are usually inboard-powered, 5.5 m (18 ft.) to 7 m (23 ft.) long, and have fairly flat bottoms so that they plane easily when pulling several skiers. They feature special fins on the bottom that allow them to turn very sharply, a ski pylon or post near the centre to attach the tow rope, and a rear-facing seat so that one passenger can keep an eye on the skier without turning around.

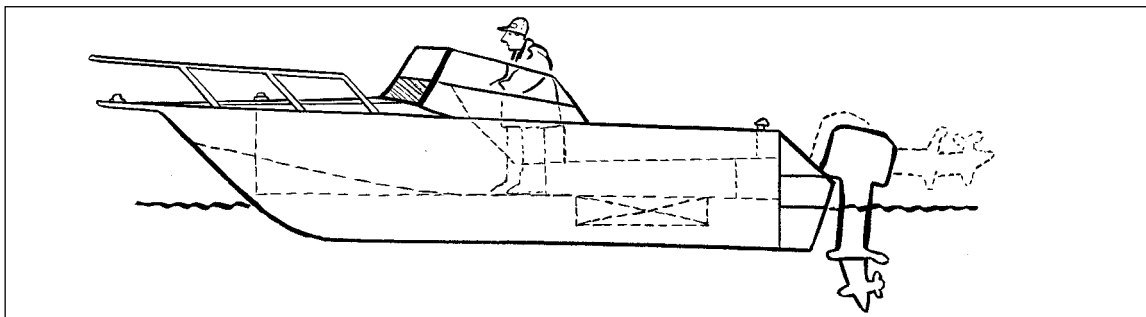

Figure 5.9: Runabout

Performance boats also share the general configuration of runabouts, but there is a difference in the engine room. Their engines are powerful in proportion to their weight. While a runabout might be powered by as little as 70 horses, performance boats sport engines of 225 to 500 horsepower. They usually have a deep V bottom to provide a soft ride at speed, but the aft several feet of the keel may be flattened into a planing pad. This pad functions like a slalom ski as speed increases, elevating the boat very high in the water and allowing it to reach speeds of 50 knots and higher.

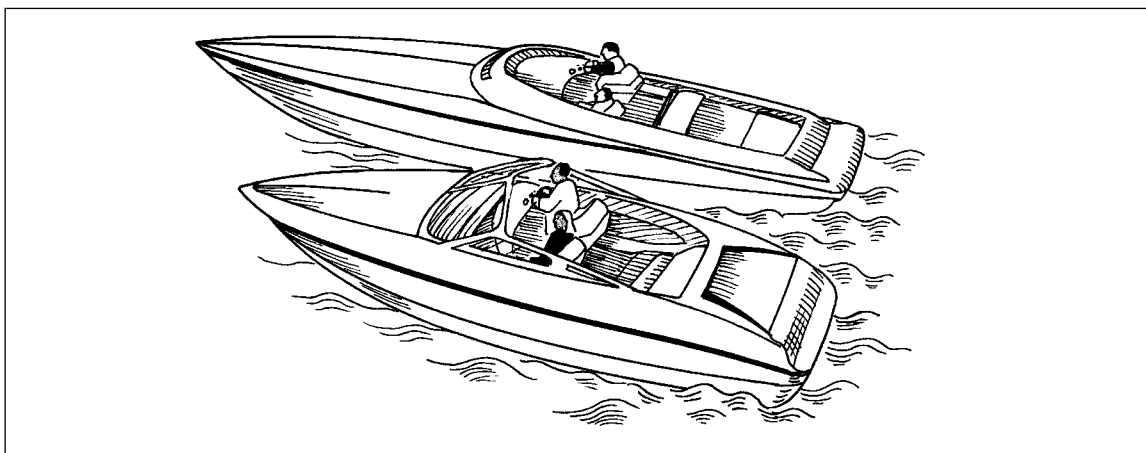

Figure 5.10: Performance boat

Speedboats include the runabout, the utilitarian Boston Whaler, launches, bass boats, and high-powered fast boats such as the “cigarette” that can reach 18 m (58 ft.).

5.2.2.2 Freshwater and saltwater fishing boats (boats for anglers)

There are all sorts of fishing boats. Many fishing boats are also used regularly as ski boats, dive boats, and casual day-cruising rigs. One variety known as the “Fish’n Ski” includes a ski pylon, walkthrough windshield, and bow-rider seats, as well as fishing seats, rod boxes, trolling sockets, and live wells. It serves double-duty.

Fishing boats can be divided into those suited for fresh water and those designed for coastal use (saltwater).

Freshwater fishing boats

Bass boats, so called because they are popular in fishing for bass, are often high-performance hulls designed to travel across big reservoirs at speeds better than a mile a minute. Raised casting decks and stern make for easy fishing. Bass boats tend to be javelin-shaped and powered by big V6 outboards producing 150 to 225 horses. Most run on a narrow pad near the transom, which causes them to plane up on top of the water much like a slalom ski, increasing speed and reducing fuel use. They are usually equipped with a silent electric trolling motor at the bow to provide low-speed manoeuvring as the angler probes for his or her quarry (silent power during fishing).

Smaller boats, some known as “jon boats” because of their squared-off bows, are popular for the pursuit of all sorts of finned creatures from catfish to sturgeon. Most of these boats are lightweight aluminum, which means they can be pushed with motors from 5 to 40 hp. The motors are portable and can be added or removed as needed.

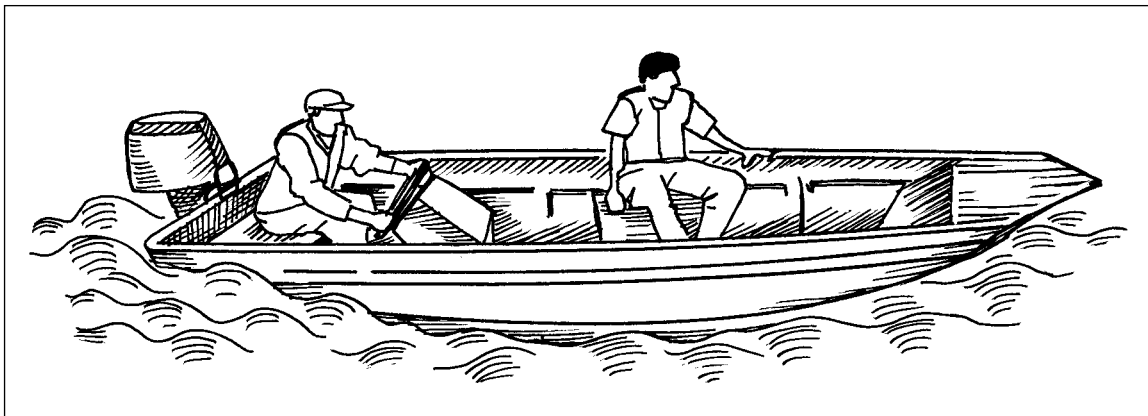

Figure 5.11: Jon Boat

Saltwater fishing boats

Coastal fishing boats fall into three general categories determined by size, seaworthiness, and price.

Most seaworthy are the big vessels designed for fishing well offshore. They range in length from 7 to 17 m (23 to 56 ft.). These boats have lots of freeboard, lots of beam, and usually twin engines. They can have centre consoles, with the wheel in the middle of the boat and fishing space both fore and aft, the preferred arrangement for those who cast for their fish.

Cuddy-cabin boats have a low cabin under the bow, usually space for bunks and a dinette, but not enough head room to stand up. Full-cabin boats have standup head room, usually a full bath or “head,” and a kitchenette or “galley.” Cabin rigs make it possible to spend the night afloat.

The “**walk-around**,” is a popular variation of the cabin boat. It has space around the sides of the cabin to allow anglers to walk to the bow for easy fishing and anchor handling, thus providing some of the advantages of the centre console, yet preserving the amenities of the full “house.” Some models include a built-in motor bracket at the stern.

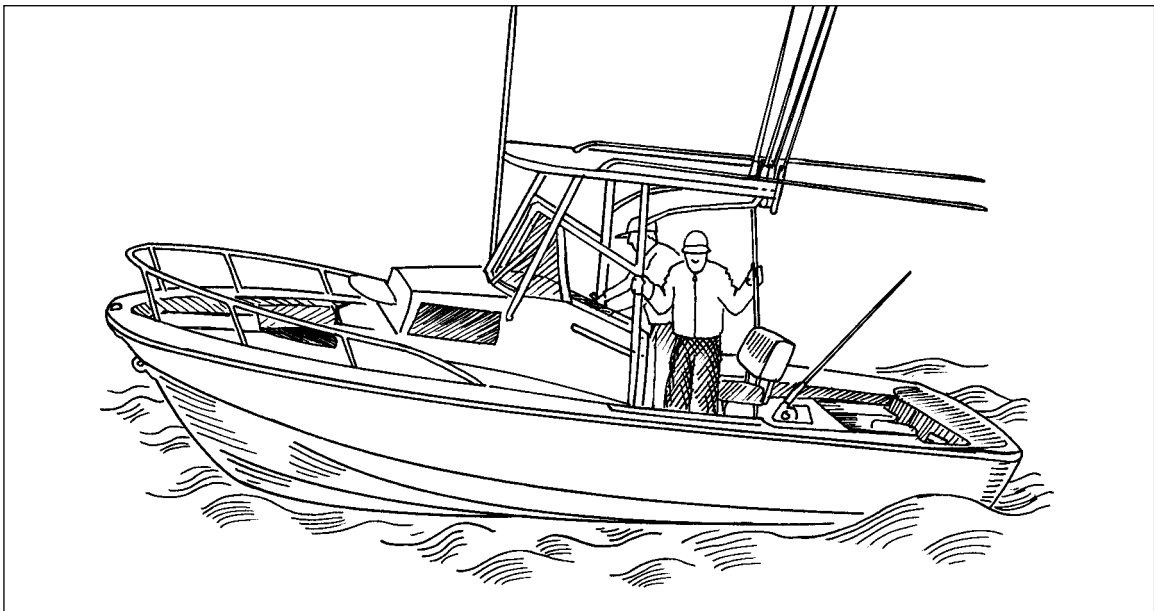

Figure 5.12: Walkaround

Bay boats have moderate V bottoms, moderate freeboard, and usually a single engine. Lengths of 5 to 7 m (16 to 23 ft.) are common. There are usually centre consoles or walk-arounds. These boats are designed to take on sizable waters, and they are often used along the ocean and gulf beaches in moderate weather.

Flat boats are designed to pursue trophy saltwater species in depths of 0.3 to 1 m. Some of these boats float in only 0.2 m (8 in.) of water and can run in as little as 0.3 m (1 ft.). Flat rigs have low freeboard so that they don't catch the wind and drift excessively. Lengths range from 4.5 to 6.5 m (15 to 20 ft.). Centre or side consoles are common, although some are simply operated from near the transom with a tiller.

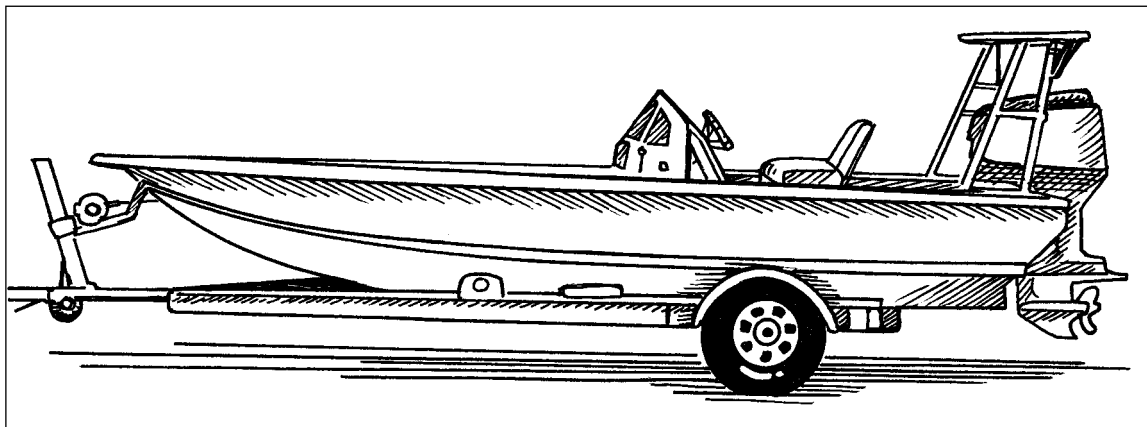

Figure 5.13: Flatboat

5.2.2.3 Cruisers, trawlers, and houseboats

Cruisers and trawlers differ from houseboats in that they have deeper-draft hulls and are more suited to taking into offshore waters and big inlets. They also usually have more power and more seaworthy fittings. Planing hulls have flattened sections on the aft bottom that allow these boats to rise almost to the surface of the water, reducing drag and increasing speed. Displacement hulls have rounded bottoms and chines that prevent these boats from reaching plane. This makes them slower than planing hulls.

Cruisers have planing hulls, which means they offer speeds not possible with displacement hulls. They are often equipped with twin engines and can cruise at better than 15 knots, reaching maximum speeds, with adequate power, of nearly 35 knots. Lengths from 10 to 17 m (32 to 56 ft.) are common.

Cabin cruisers include both displacement and planing hulls, but increasingly have planing hulls with comfortable overnight accommodations.

The common feature to these boats is a big reliable engine, or engines, usually diesel, perched deep within the hull. The size range of cabin cruisers is from 6 to 60 m (20 to 200 ft.).

Trawlers nearly always have displacement hulls and rounded bottoms where speed is limited by the waterline length. No matter how much power you put on a round-bottomed trawler, it still chugs along at a speed of somewhere south of 10 knots. Cruising speeds of up to 10 knots are typical, so you need to have plenty of time to go anywhere in a trawler. However, the round hulls are extremely seaworthy, and displacement speeds are very fuel-efficient. This is the reason why many long-distance travelers choose trawlers. Equipped with a small diesel inboard, some can travel over 1,000 miles between refuelings. Lengths range from about 8.5 to 15 m (28 to 50 ft.).

Houseboats are the camper-trailers of the watery world for those who do most of their boating in protected waters.

Many houseboats ride atop a pair of aluminum cylinders known as pontoons, although some models have fibreglass V hulls. Lengths range from 7.5 to 30 m (25 to 100 ft.). Power is usually an outboard of 30 to 100 horses, although the larger rigs have inboard power. There are actual conventional rooms aboard – kitchens, dining rooms, living rooms, bedrooms, and bathrooms, all on one level.

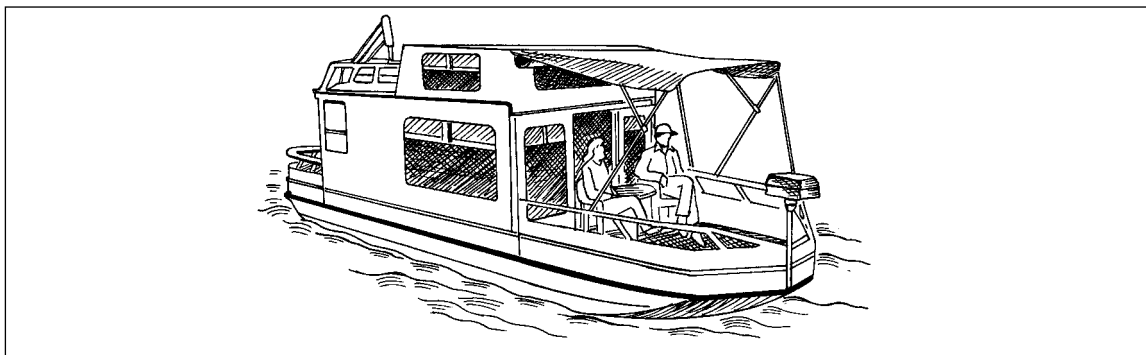

Figure 5.14: Houseboat

5.2.2.4 Pontoon and deck-type boats

Pontoon boats and deck-type boats feature couches, dinettes, sinks, refrigerators and usually portable marine toilets, but no sleeping areas and no permanent roof. Weather protection is usually from a convertible top. They are tall enough to stand under, but with no side panels to prevent air circulation.

Pontoon boats ride on aluminum or fibreglass “logs” or cylinders filled with foam. Pontoon boats ride on the same sort of aluminum cylinders as many houseboats. They can be powered by motors as small as 10 HP and rarely more than 60 HP.

Decked boats look much the same as pontoon boats from the deck upward, with couches, lounge chairs, tables, and maybe a portable TV and barbecue grill. But below the deck is a semi-V hull that allows full planing operation with adequate power. They can handle motors of 50 to 150 horses and speed along 25 to 45 knots, making them good ski boats.

5.2.2.5 Personal watercraft

Personal watercraft (PWCs) are the motorcycles of the boating world, designed for thrills and speed rather than comfort.

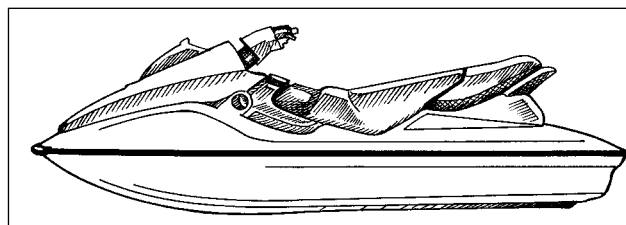

Figure 5.15: Personal watercraft

Most PWCs are under 3 m (10 ft.) long. The seats are saddles, and steering is done with handlebars. The power for these boats is via a water-jet instead of the open-bladed propeller found on conventional boats. This safety measure also enables the craft to do spectacular end-for-end turns.

The power ranges from 40 to 110 HP, which can result in speeds to 60 knots or more with some models, given the light weight of these boats.

5.2.2.6 Inflatable boats

Inflatable boats are basically waterborne balloons, but a lot tougher. Multiple air chambers and very stout skins on modern inflatables make them extremely durable.

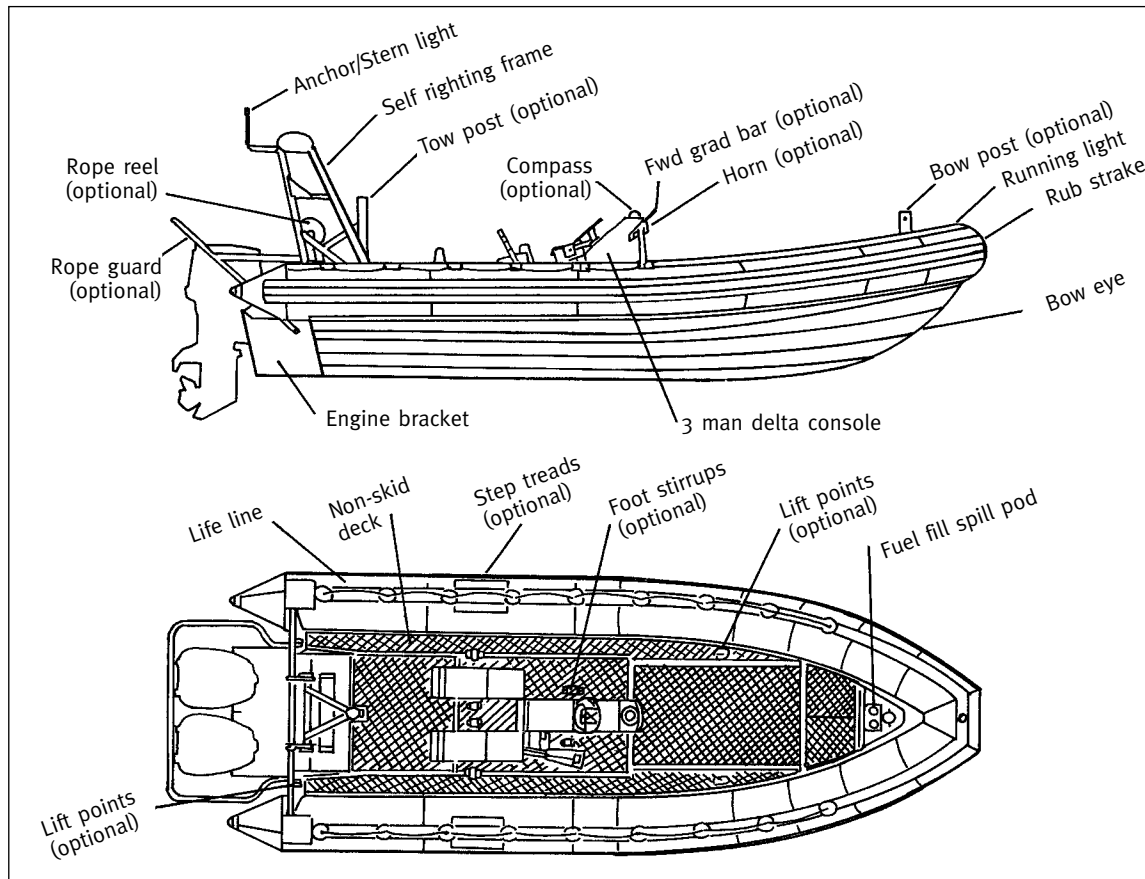

Figure 5.16: Rigid hull inflatable boat (FRC)

Inflatables are favorites as yacht tenders because their light weight makes them easy to bring aboard, and they can be stored deflated to save space. The soft sides also do not mar a yacht's finish as a hard-sided dinghy might.

Add a fiberglass bottom, as many larger inflatables have, and you have a boat within a boat, a V bottom to soften the ride and the giant sponsons to provide that remarkable flotation and ability to bump into things without scratching or bending. Some inflatables have twin outboards, so they can really fly.

Lengths range from 2 to 7 m (6.5 to 24 ft.).

The **Canadian Coast Guard** uses **Fast Rescue Crafts (FRCs)**, which are a combination of rigid and inflatable construction. These Rigid Hull Inflatable Boats (RHIBs) are designed as a fast rescue or patrol boat, and can be deployed either from a trailer or from a shipboard davit.

The deep-V rigid hull in combination with the inflatable collar provides a dry, stable ride in most sea conditions. The inflatable collar not only supplies reserve buoyancy, but also acts as an energy sink to soften the ride in rough conditions.

The FRC is an extremely stable craft. The conditions under which this craft will flip over would have to be classified as extreme. If the craft should get caught in conditions which capsize it, the manually activated self righting system will bring the boat back onto its keel.

The most common type is 7.3 m (24 ft.) long with twin motors which have a maximum horsepower of 2 x 150 and can reach a maximum speed of near 46 knots. The person capacity is 18.

5.2.2.7 Canoes, kayaks, and rowboats

Also in a class of their own are boats that depend on humans to supply the power. These boats range in length from 2.5 to 5.5 m (8 to 18 ft.).

Canoes come in a wide variety of designs, with the lowest, smallest, and lightest designed for easier carrying and better performance but less load and less stability.

Some modern canoes are molded from flexible plastics that bounce off rocks with ease, yet are light enough for easy handling solo.

The most common canoe shape features an unswept bow and stern, with relatively low freeboard amidships. Some canoes are square-enders, with a flat stern or transom where a small electric motor or gasoline outboard can be mounted. Double-ender canoes can be fitted with a side-mount for a small outboard.

Kayaks differ from canoes primarily in that the top is closed over in most, helping to keep water out. Most kayaks are designed for one person only, although a few can handle two people. They are narrower than canoes and designed to be paddled with a two-bladed paddle.

Typical kayaks measure about 0.5 to 0.8 m (1.5 to 2.5 ft.) wide and 3.5 to 5.5 m (12 to 18 ft.) long.

Rowboats used to be planked or plywood, but the most common material in rowboats today is aluminum.

Rowing differs from paddling in that the paddles of a rowboat, called the oars, are secured in oarlocks.

Most rowboats except sculls also have square sterns, so that they can also be operated with electrical or gasoline motors of 5 to 10 horses.

Rowboats made with a blunt bow and a flat bottom are known as **jon boats**. Rowboats made with a tapered bow and slight V bottom are known as **utility boats**. Both jon boats and utility boats have flat transoms and can be powered by outboards as well as rowed.

5.2.3 Fishing vessels

Fishing vessels are of various shapes and sizes, depending on their location, the kind of fishing and the kind of water they fish into. All fishing vessels are relatively large to provide enough space for daily captures. They often are well equipped with electronics such as RADAR, GPS and depth sounder. Many deck fittings are available on these vessels and they are usually heavy duty.

5.2.3.1 Side trawler

A fishing vessel that deploys the trawl-net over the side of the vessel.

5.2.3.2 Stern trawler

A fishing vessel designed for trawling, in which the nets are hauled in over the stern, up a ramp or over a roller or the bulwark with a derrick or gantry.

5.2.3.3 Outrigger trawler or beam trawler

A trawler in which the fishing gear is towed from outrigger booms. The towing warps go through blocks at the ends of the outriggers. These vessels are commonly used for shrimp trawling.

5.2.3.4 Tuna purse seiner

A fishing vessel equipped to handle the large and heavy purse seine nets required for tuna.

5.2.3.5 Purse seiner

A fishing vessel employing nets that hang vertically in the water, the ends being drawn together as in a purse so as to enclose the fish. The vessel is equipped with pursing gallows and pursing winches for hauling in the purse lines which close the net after it settles.

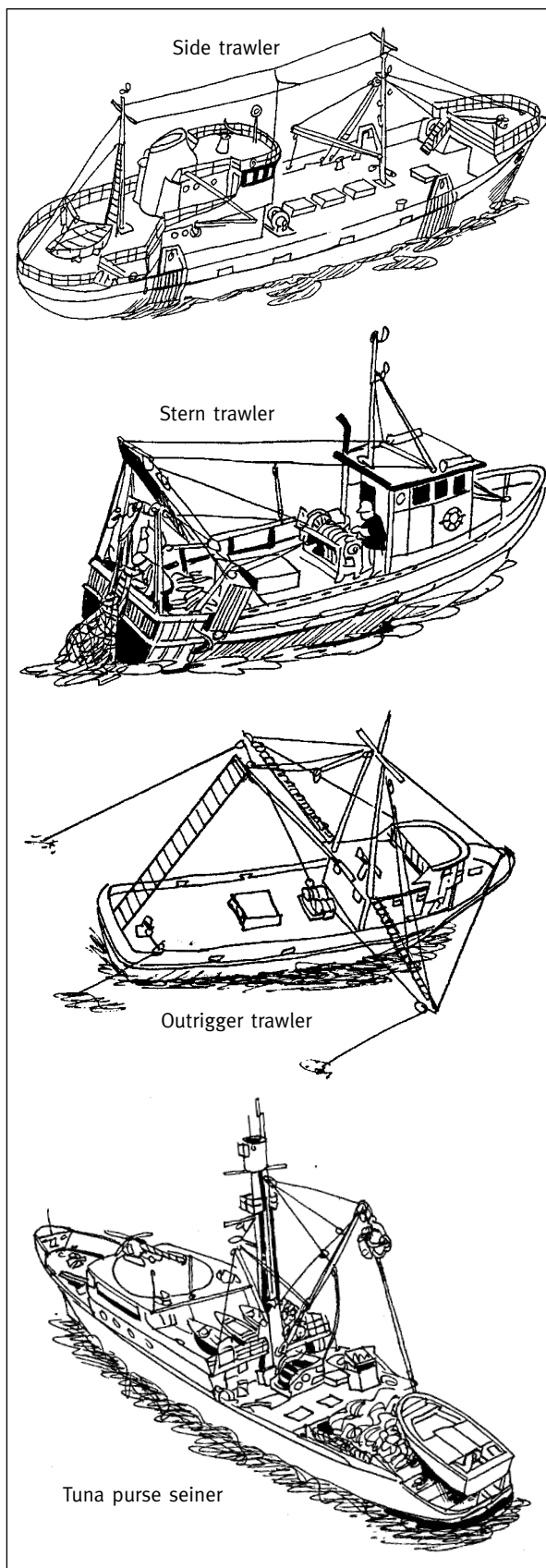

Figure 5.17a: Various fishing vessels

5.2.3.6 Dredger

A fishing vessel which employs a dredge for collecting shellfish from the seabed.

5.2.3.7 Lift-netter

A fishing vessel equipped to operate large lift nets, which are held from the ship's side and raised and lowered by means of outriggers. They sometimes feature sets of powerful lights above and below water to attract fish.

5.2.3.8 Pot vessel

A fishing vessel used for setting pots intended for catching lobsters, crabs, crayfish and similar species. Pot vessels range from open boats operating inshore to larger vessels of 20 to 50 m (66 to 164 ft.) operating out to the edge of the continental shelf.

5.2.3.9 Longliner

This is a fishing vessel employing longlines. Longlines can be operated from vessels of any size. they are long fishing lines with baited fishing hooks attached at regular intervals. Bottom longlines are placed on or near the bottom, and drifting longlines are maintained at the surface or at a specified depth by means of floats. Several automatic or semi-automatic systems are used on larger boats to bait the hooks and to deploy and haul the lines.

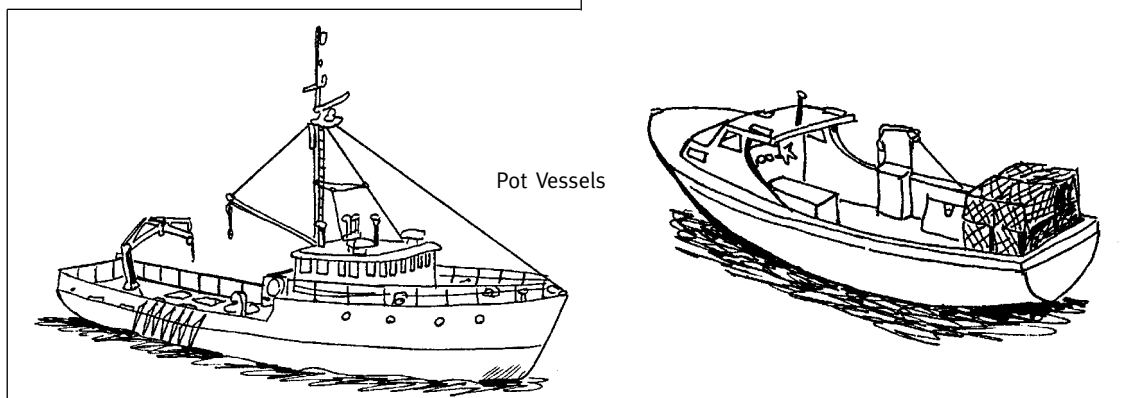
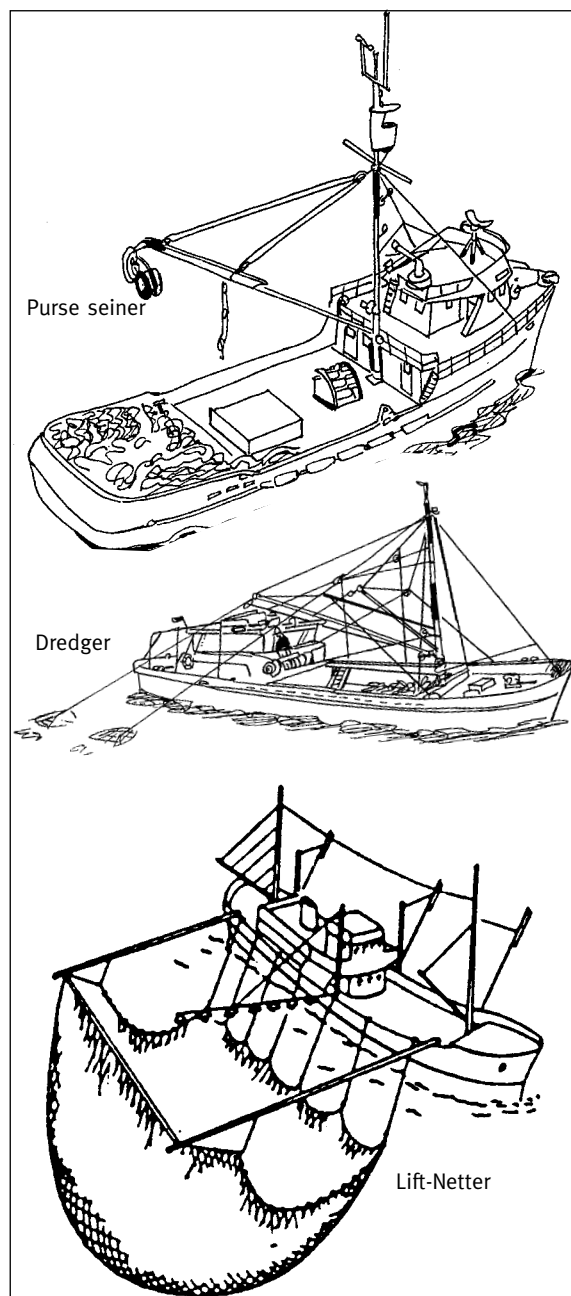

Figure 5.17b: Various fishing vessels

5.2.3.10 Tuna longliner

A fishing vessel employing longlines for catching tuna. It is usually a medium-sized vessel, with the line hauling winch placed on the starboard side forward and a gate in the rail for hauling in the fish. Typical equipment includes brine freezing tanks in which the tuna are preserved.

5.2.3.11 Pole-and-line vessel

A fishing vessel used primarily for catching tuna and skipjack. Fishers stand on the railing or special platforms and fish with poles to which lines with hooks are attached. Tanks with live bait and a water spray system for attracting fish are typical features of these vessels.

The two types of pole and line vessels are the Japanese type, in which the fishers stand at the railing at the forward end of the vessel, and the American type, in which the fishers stand on platforms at the stern.

5.2.3.12 Troller

A vessel used for catching deepwater groundfish by towing a number of lines fitted with lures.

The lines are attached to trolling booms which are raised and lowered by topping lifts and fore and aft stays. Hydraulic or electrically powered reels (or gurdies) are frequently used in the lines.

5.2.3.13 Pump fishing vessel

These are fishing vessels equipped with specially-constructed pumps. During the fishing operation, the pump is lowered under the surface of the water. Small fish attracted by light from a lamp situated above the suction side of the pump are sucked in and pumped on board, where a fish/water separator is located.

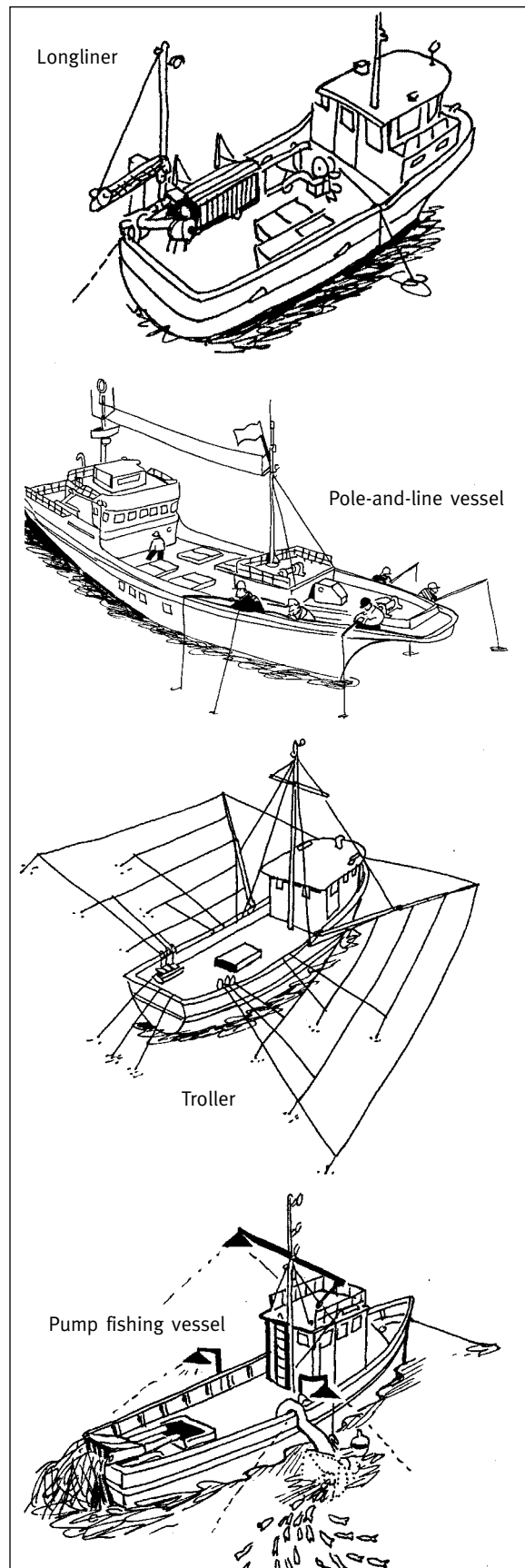

Figure 5.17c: Various fishing vessels

5.2.3.14 Trawler-purse seiner

This is a multi-purpose vessel capable of fishing with either a trawl or a purse seine. An example of this type of vessel is the North European type of seine boat or seiner, which has been fitted with additional gear to enable it to carry out deep-sea trawling. One or two boats are carried on board.

5.3 BOAT MOTIONS

There are three terms used to describe the motions of a boat on the water: roll, pitch and yaw. When a vessel leans to one side, then to the other in continued repetitive motion, the vessel is **rolling**. Excessive rolling may cause a vessel to capsize. Whereas rolling is a lateral motion about the longitudinal axis of a boat, **pitching** is a motion about the lateral axis of the boat. The bow and stern rise and fall in this motion. In excessive waves, a vessel may **pitch-pole**, that is, capsize end-over-end. In **yawing**, a vessel will tend to wander randomly off course, especially under the influence of following seas. It is a dangerous situation in which loss of control can lead to **broaching to** or coming beam to sea and rolling over.

5.4 ROPES

5.4.1 Types and characteristics of ropes

5.4.1.1 Twisted vs. braided ropes

There are two broad categories of rope: twisted and braided. A twisted rope is formed by coiling three strands together in the same direction. Twisted ropes have a tendency to unravel at the ends. All ends of such ropes must be fused, taped or spliced to prevent unraveling. The lay of rope is a term used to describe the nature of the twist that produces the completed rope. The purpose of alternate twisting of fibre, yarns and strands is to prevent the rope from becoming unlayed during use. Twisted ropes may be of a right-hand lay or left-hand lay, but the most common is the right-handed. It is essential to realize that each of the components is turned (twisted) in the opposite direction to that of its predecessor, e.g., in right-hand lay, strands are laid up right-handed (clockwise), yarns laid up left-handed, and fibres laid up right-handed.

There are three general categories of braided rope construction: diamond braid with a core, hollow braid (diamond braid without a core) and solid braid. Diamond braid is done by weaving ends of yarn over and under, just like the maypole dance is done. When a core is present, the rope cannot be spliced. When no core is present (hollow braid), the rope can be spliced relatively easily. Solid braided ropes are very firm, and because they are tightly woven, they do not tend to unravel easily when cut or torn. Solid braided ropes also have good chafing resistance, but they cannot be spliced. When both the rope and its core are braided, the rope is referred to as “braid-on-braid” or “double braid.” This construction usually makes very strong (end expensive) ropes.

Fibre ropes are made from either natural or synthetic fibres. Natural fibres include manila, sisal hemp and cotton, and synthetic fibres traditionally include nylon, polyethylene, polypropylene and the polyesters.

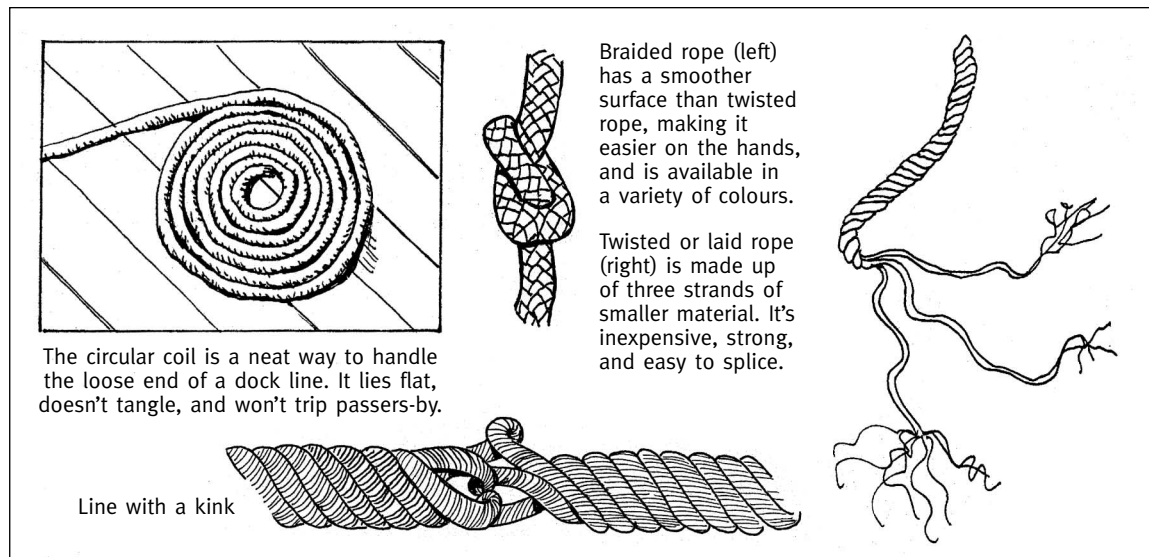

Figure 5.18: Twisted, braided rope

5.4.2 Natural Fibre Rope

Natural fibre ropes are usually manufactured from manila, sisal, cotton or hemp fibres. Most natural fibre ropes are twisted. Natural fibres are rarely braided (the exception being cotton).

Natural fibre ropes should be maintained in a clean and dry state, as rot and mildew are their main causes of deterioration. They are, however, more resistant to heat than traditional synthetic fibre ropes: they do not burn quickly and their breakdown is slower. Manila ropes deteriorate by prolonged exposure to sunlight; they should be covered or shaded if possible.

Although they have been extensively used in the past, natural fibres are slowly but surely becoming a rarer sight in the maritime industry.

5.4.2.1 Sisal

Obtained from the leaves of the plant *Agave Sisalana*, a large plant of the cactus family, sisal comes largely from Russia, America, East Africa, Italy, Java, and countries in Central America. The plant prefers a temperate or tropical climate.

The sisal rope is hairy, coarse, and white. It is neither as pliable as manila nor as strong. When wet, it swells more than manila, as the water is absorbed more quickly, and the rope becomes slippery to handle.

Sisal rope was once extensively used in the shipping industry, either in its own state or mixed with manila fibres, a good sisal being similar in strength to a low-grade manila. The cost of production is better suited to the ship owner, and the supply is more accessible than manila. Today, sisal is also used as core in wire ropes.

For handling purposes, the fibres have a brittle texture, and continued handling without gloves could cause the hands to become sore and uncomfortable. It is generally used for mooring ropes in ships and most other general duties aboard, where risk of life is not an issue. When the rope is expected to be continually immersed in water, it may be coated with a water repellent. This chemical coating, usually tar-based, will prevent rotting and mildew.

5.4.2.2 Hemp

Hemp is obtained from the stem of the plant *Cannabis Sativa*, which yields flax for the production of canvas. (The word canvas is derived from the Latin “cannabis,” which means hemp). This was accepted as the best rope in the marine industry from the early developing days of sail. *Cannabis Sativa* is cultivated in many parts of the world – New Zealand, Russia, China, India, and the USA – but has been replaced mainly by man-made fibre ropes and manila.

The hemp fibres are light cream in colour when supplied to the rope manufacturer. They have a silky texture and are of a very fine nature: hence the extra flexibility of hemp rope compared to sisal or manila.

Most hemp ropes are treated during production, and the result is a tarred, brown rope that is hard and hairy to the touch. Its strength will depend on the place of production. Italian hemp ropes are now considered to be the best quality, having about 20% greater strength than a high-grade manila. However, quality varies considerably, and hemp ropes are rarely seen at sea today except in small uses like lead line, cable laid hemp, sea anchor hawsers, bolt rope, etc.

The advantage of hemp rope is that it is impervious to water and does not shrink or swell when wet. For this reason, it was extensively used for the rigging of sailing vessels and roping sails. When used for running rigging, it was preferred to manila or sisal because it did not swell and foul the blocks. However, for vessels navigating in cold climates, hemp ropes do have the tendency to freeze up. Not all hemp ropes are supplied tarred, so the weight and the strength will vary.

5.4.2.3 Manila

Manila is obtained from the abaca (wild banana) plant, which grows to about 9 m (30 ft) in height, largely in the Philippine Islands, and is exported via the port of Manila, from which it acquires its name.

Manila rope is not as durable as hemp, but is certainly more pliable and softer. It is gold-brown in colour, and never tarred. Unfortunately, it swells when it is wet, but it is still considered by far the strongest natural rope made. It is very expensive and its availability will depend on the political climate.

5.4.3 Synthetic Fibre Ropes

Synthetic ropes are stronger than natural fibre ropes as they have individual fibres running along their entire length, rather than short, overlapped fibres. They are generally impervious to rot, mildew and fungus, and have good resistance to chemicals. They do not stiffen when wet, do not freeze and have good dielectric properties when clean and dry. Polypropylene in particular absorbs no moisture at all. Synthetic ropes are also lighter, easier to handle, and have good abrasion resistance. They far outwear manila ropes.

Although natural fibre ropes are still used throughout the marine industry, they have been superseded by synthetic fibres for a great many purposes. Not only do the majority of synthetic ropes have greater strength than their natural fibre counterparts, but they are more easily obtainable and now considerably cheaper.

List of synthetic fibres used in making ropes

Fibre	Characteristics
Nylon	High elasticity
Polyesters Dacron®	Low elasticity
Terylene®	Note: Dacron and Terylene were the very first polyester fibres produced.
Kevlar®	High heat resistance, low elasticity and high strength
Vectran®	High strength and low elasticity
HMWPE UHMWPE	High strength, low elasticity and floating capability
Dyneema® Spectra®	Notes: HMWPE refers to High Molecular Weight Polyethylene UHMWPE refers to Ultra High Molecular Weight Polyethylene
Technora®	Low elasticity, high strength, high heat resistance
Polyolefin®	Light weight, floating capability.

5.4.3.1 Nylon

Nylon is the best known and most used of the synthetic fibre used in ropes. It has high breaking strength, whether wet or dry, and good sunlight and weather resistance. It is highly elastic, and its elongation under a load is 10% to 40%. When the load is released, the increase in length is approximately 7%.

Nylon ropes are used for such functions as shock absorbing when coupled with a mooring wire, and are attached to fenders to permit movement as the vessel moves up and down against the dock.

Nylon ropes are light to handle, twice as strong as an equivalent-sized manila, and give the appearance of a smooth slippery surface. They have a high melting point, 250°C, and are pliable in normal temperature, which is desirable for most forms of rigging.

The disadvantages of nylon ropes are that they do not float, and in cold climates, they tend to stiffen and become difficult to handle. They also have a tendency to become slippery when wet. They will lose approximately 10% of their strength when wet, but they regain it when they dry out. They should not be exposed to strong sunlight or stowed on hot deck surfaces, as their useful life will be impaired. They should thus be stored away from heat and sunlight. Nylon ropes are attacked by most acids and paints, and contact with chemicals should be avoided.

The significant point with these ropes is that they are used when great stress occurs. Should they give way under such stress, there is a tendency for them to act like an elastic band. Serious injury could occur if someone happened to be in the path of the rope at that time. The nylon rope will give no audible warning when about to give way; however, during excessive stress, the size of the rope will reduce significantly. These ropes are difficult to render on a set of bitts, and should never be allowed to surge. Any splices in nylon ropes tend to draw more easily than in natural fibre when under stress.

5.4.3.2 Polyesters

Polyesters (initially known as Dacron® and Terylene®) are not as strong as nylon and have inferior stretch properties. They have a similar abrasion and temperature resistance to those of nylon.

Polyesters are considered to be more resistant to acids, oils and organic solvents than their nylon counterparts, while their strength remains the same in wet or dry conditions. These characteristics make them ideal for most running rigging of sailboats.

The disadvantage of polyester is very similar to that of nylon. It will not float. It should be kept to a minimum when working about bitts or warping drums. The melting point is between 230 and 250°C.

5.4.3.3 Polypropylene

Polypropylene is light and floats on water, but it has lower strength than nylon and polyester. It is unsuitable for use in hot conditions, as it softens progressively with increases in temperature and has a relatively low melting point (165°C). Friction-generated heat should also be avoided. Should the fibres fuse together, the rope is permanently damaged and weakened. Polypropylene ropes degrade in sunlight, but do not lose strength when wet and are not attacked by rot and mildew. They are highly resistant to acids and alkalis, but solvents and bleaching agents may cause deterioration. They are used extensively for mooring ropes, running rigging and towlines.

Polypropylene neither absorbs nor retains water, and for this reason has recently been used for the inner core of wire ropes, eliminating inner corrosion in the wire. However, the wire still needs to be lubricated externally.

5.5 KNOTS, BENDS, HITCHES AND RELATED ITEMS

5.5.1 General

Knots have many uses in the maritime world. However, not all knots are equal. Some knots are better than others. This section lists various knots that meet the three important conditions for all good knots:

1. easy to do;
2. easy to undo;
3. safe (if used as recommended).

Before going any further into this topic, the reader must understand that any fastening (knot, bend or hitch) reduces the strength of a rope. Knots and bends reduce the rope strength by up to 50%, while hitches reduce it by 25%. Well-executed splices can be used to join ropes while retaining 80% or more of rope strength.

Most knots in polyethylene or polypropylene monofilament ropes tend to slip. These knots must be “doubled-up” in order to hold, due to the waxy monofilament surfaces.

5.5.2 Knots

5.5.2.1 Bowline

The bowline is one of the most valuable knots for day-to-day use on a boat. It is really a variation of the sheet bend, made with a single rather than two lengths of line. It is a non-slip knot and easy to untie after it has been under load. Two bowlines can safely join two toelines of equal or unequal size.

5.5.2.2 Square knot

Also called a reef knot, the square knot is used to fasten two lines of equal size when no great load is anticipated. If used to connect lines of different sizes, it will slip. If used to join two toelines, the knot will jam under heavy stress and be extremely difficult to untie. The square knot needs tension on both lines, for a sharp pull on one of the ends may cause the knot to fall into two half hitches.

WARNING

Never use this knot to join two lines when significant loads are anticipated. Never rely on this knot when life, limb or valuable property is involved. Severe injury or damage could result from misuse of this knot.

5.5.2.3 Figure-eight knot

The figure-eight knot is very strong, especially when doubled. It can be used to make a loop (as an alternative to the bowline) to fasten two lines of equivalent diameter together. Sailors also use it to ensure that halyards remain in their pulleys.

5.5.3 Bends

Bends are used when it is necessary to lengthen one line by joining it to another. They are not intended to be permanent, but rather are used as a temporary means of adding length to a line.

5.5.3.1 Sheet bend

A single sheet bend, also known as a becket bend, is used to join lines of unequal thickness.

The double sheet bend gives a more secure connection when unequal-sized lines are used, particularly when one line is considerably thicker than the other. With the ends on opposite sides, it is especially useful with slippery synthetic lines.

5.5.3.2 Fisherman's bend

Used to secure a rope to a buoy, or a hawser to the ring or harp of an anchor.

5.5.4 Hitches

Hitches are used to secure lines to objects such as rings or eyes. They are generally used to make temporary fastenings; one of their distinct advantages is that they can be untied quickly.

5.5.4.1 Half hitch

These can be useful to bend the end of a rope to a spar, stanchion, bollard or ring. To reinforce or strengthen the single half hitch, two half hitches may be used. The resulting knot is known as a double half hitch.

5.5.4.2 Timber hitch

Like the double half hitch, this hitch can also be used to bend the end of a rope to a spar, stanchion, bollard or ring.

5.5.4.3 Clove hitch

The clove hitch is a good choice to use when temporarily securing a line to another rope, a railing, spar or similar object. It can work loose and should not be left unattended. Under heavy load, it can jam tightly.

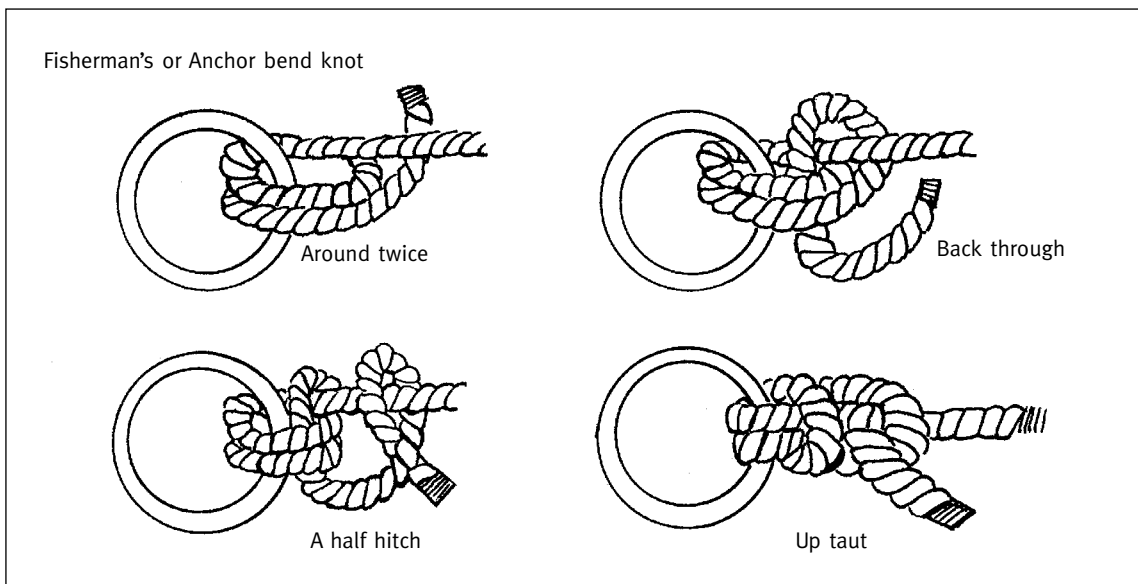

Figure 5.19a: Various knots

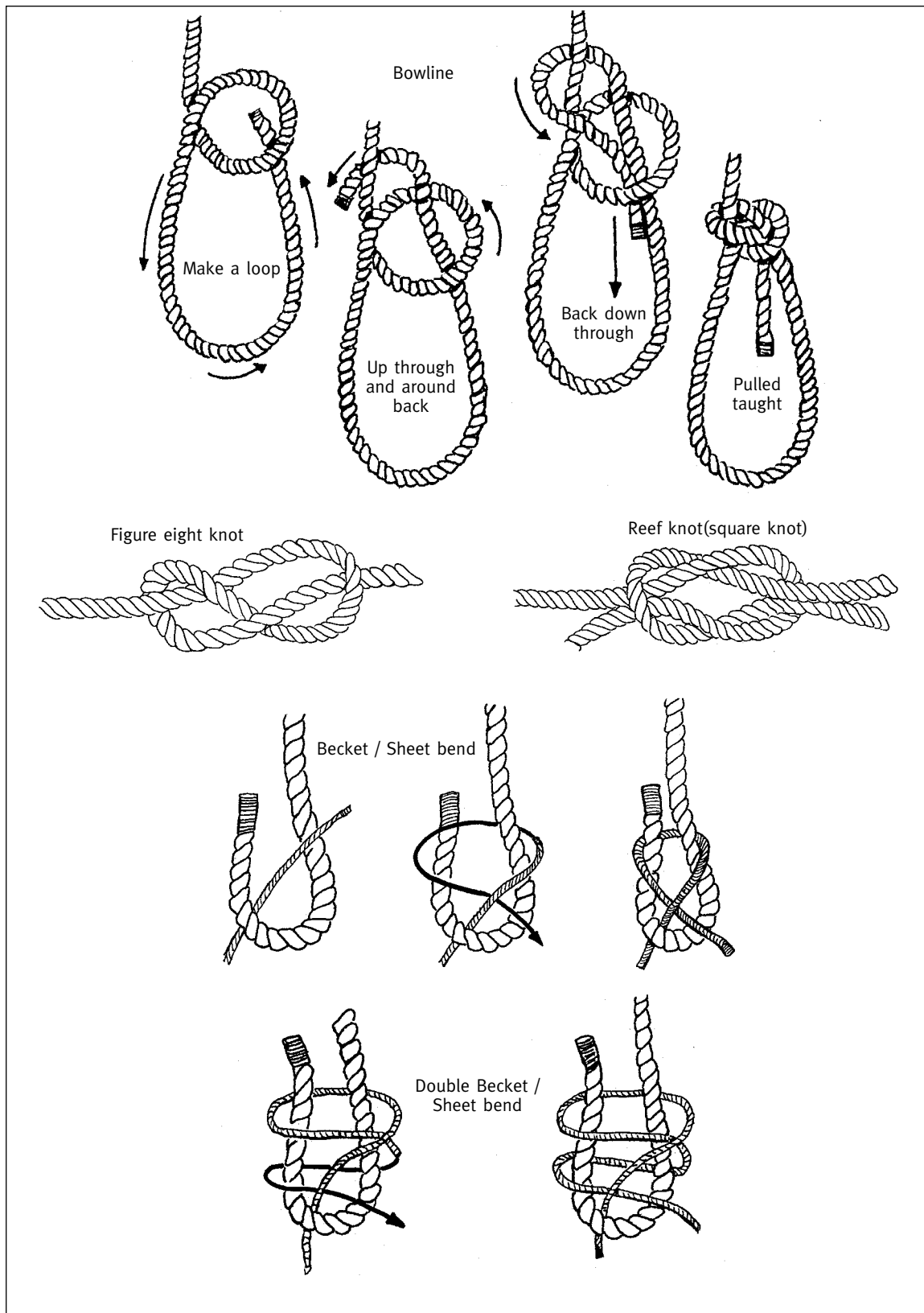

Figure 5.19b: Various knots

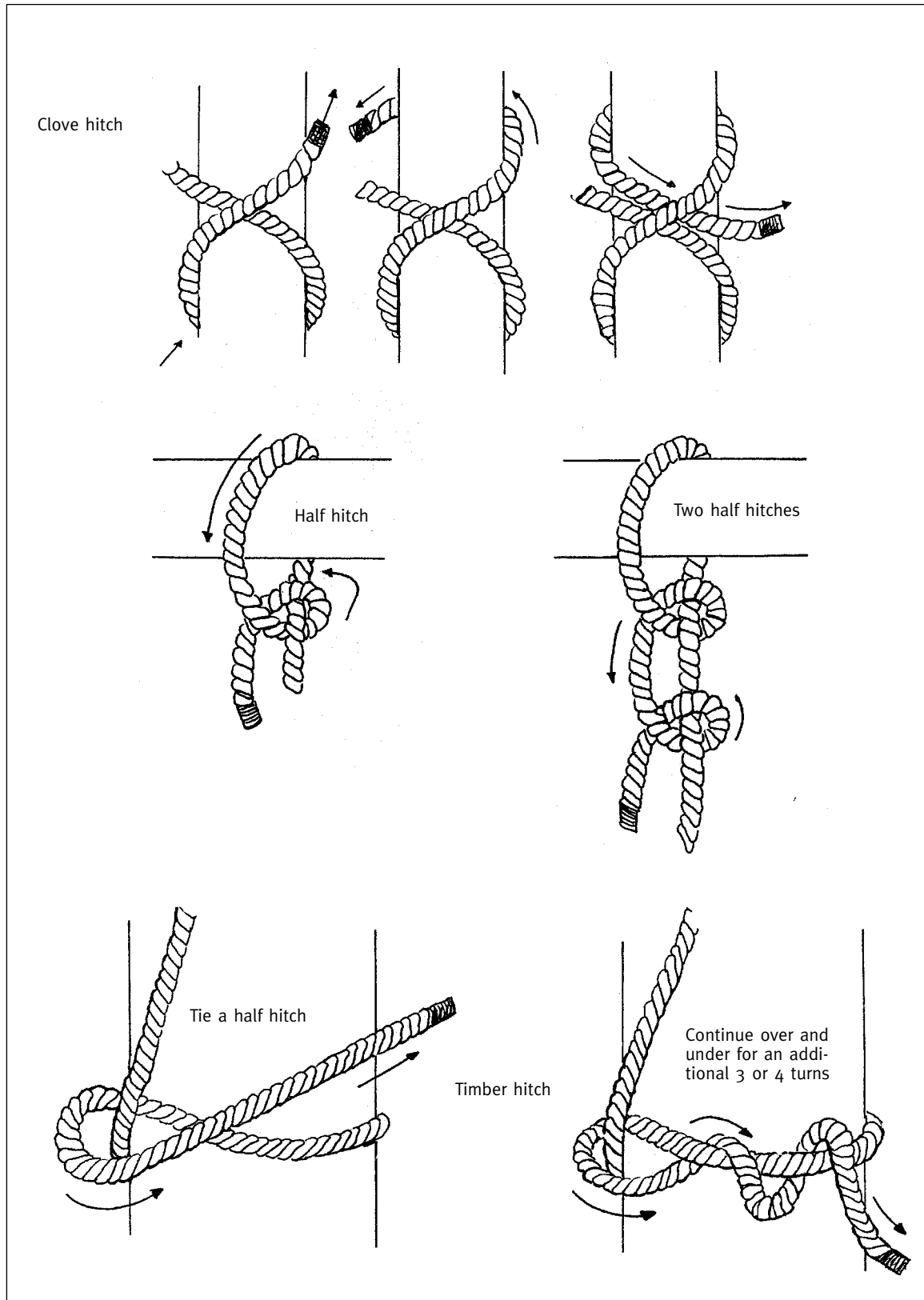

Figure 5.19c: Various knots

5.5.5 Whipping

Whenever a fibre rope is cut, the rope ends must be bound or whipped to prevent the rope from untwisting or fraying, and the strands from slipping in relation to each other, causing one of them to assume more or less than its share of the load. Each of these conditions results in shortened rope life.

Ordinary whippings are made with fine twine as follows. Make a loop in the end of the rope, as shown in the illustration. Wind the standing part around the rope, covering the loop of the whipping, but leave a small loop uncovered, as shown. Thread the remainder of the standing end up through the small loop and pull the dead end of the twine, thus pulling the standing end and the small loop (through which it is threaded) back towards the end of the rope underneath the whipping. Pull the dead end of the twine until the small loop with the standing end through it reaches a point midway underneath the whipping. Trim both ends of the yarn close up against the loops of the whipping.

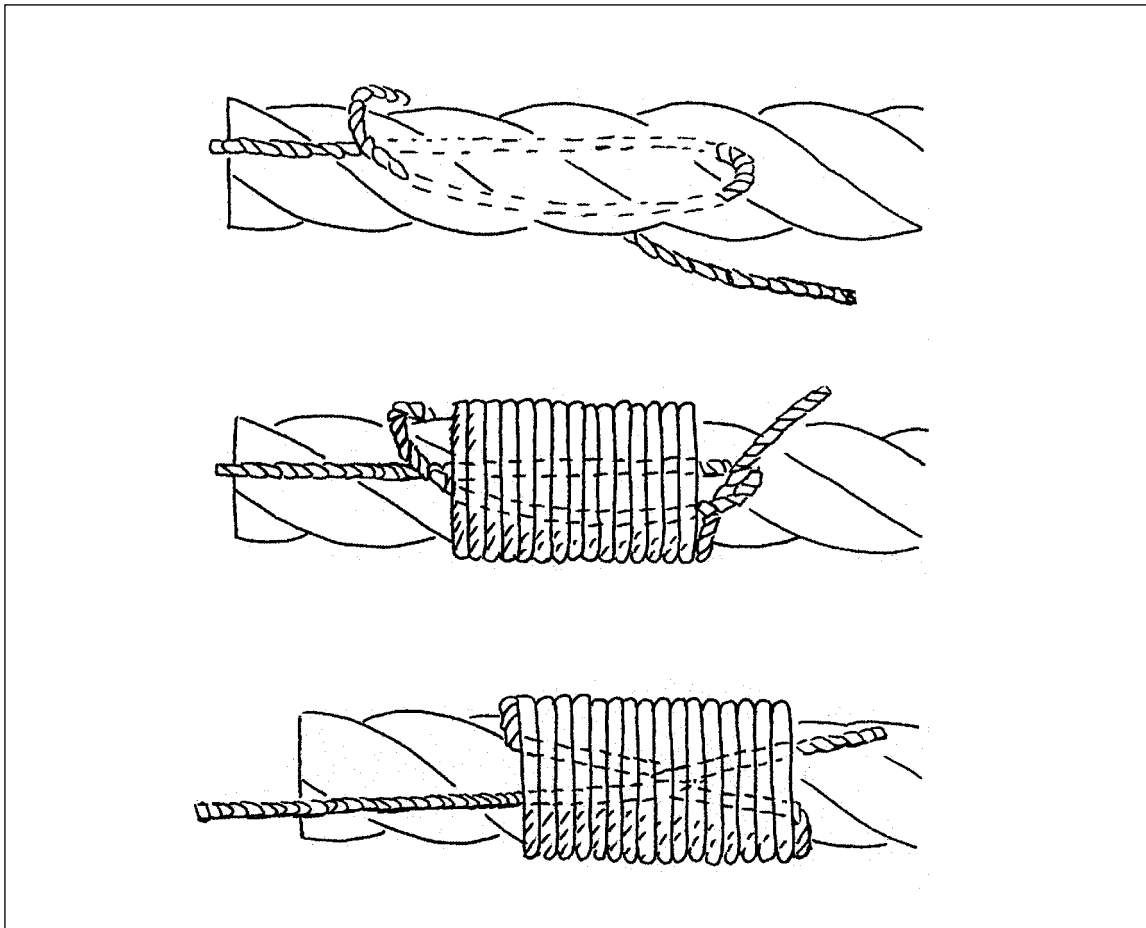

Figure 5.20: How to whip the end of a rope

5.5.6 Splicing

5.5.6.1 Short splice

Never knot a rope at a break. Cut away the broken ends and splice it together. A short splice is used when the rope does not have to be put through a small pulley or when only a small amount of rope can be used to make a splice.

5.5.6.2 Long splice

This splice is used for pulley work, as the spliced ropes run through sheave blocks without jamming.

5.5.6.3 Eye splice

This splice is used for forming an eye or loop in the end of a rope.

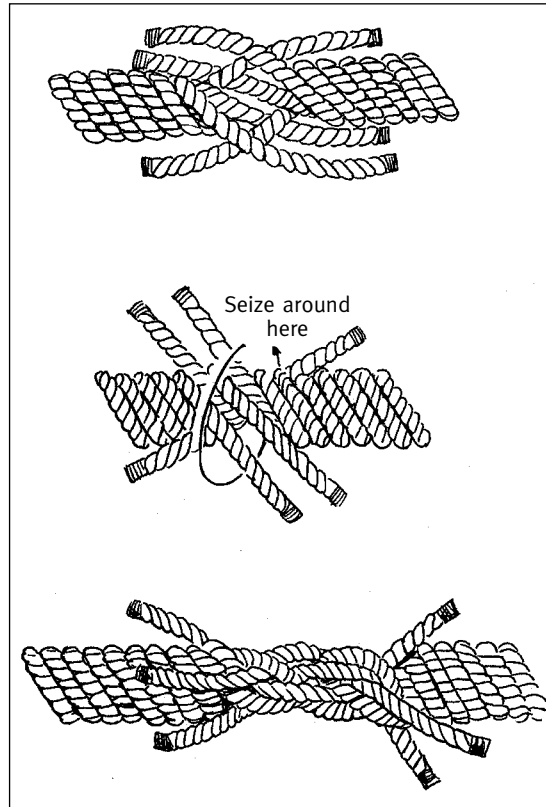

Figure 5.21:
How to do a short splice

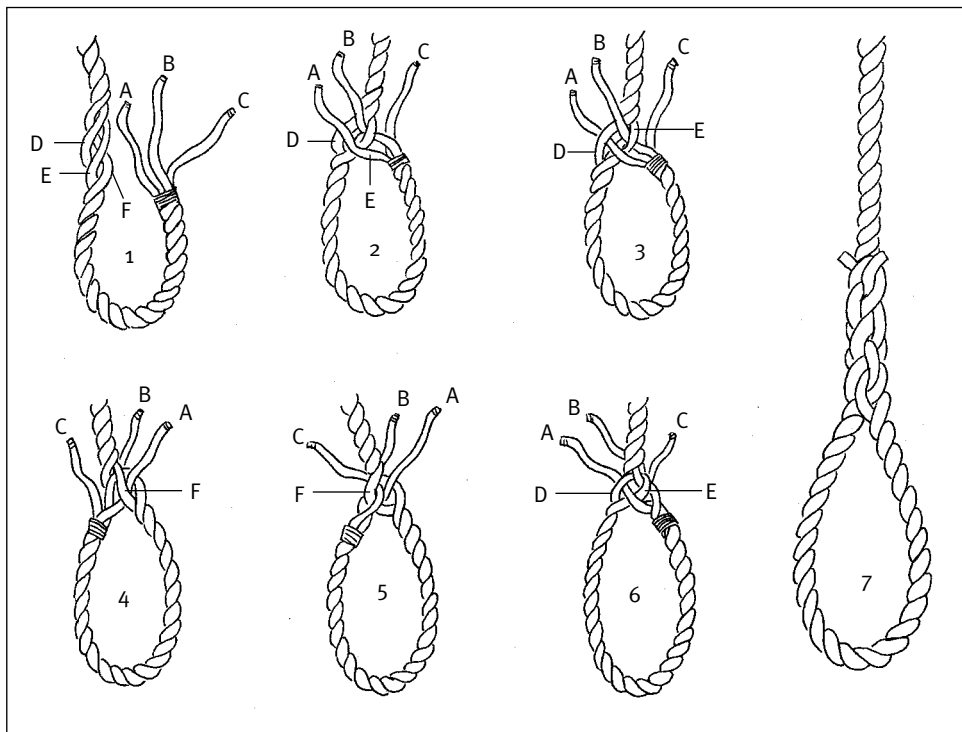

Figure 5.22: *How to do an eye splice*

5.5.7 Using ropes with deck fittings

5.5.7.1 Securing a line to a standard cleat

The cleat is the most common fitting found on recreational craft. Take a complete round turn around the base of the cleat and lead the line around the horn to form a figure eight. When the cleat is of insufficient size for two complete figure eights, a half hitch may be substituted for the second figure eight.

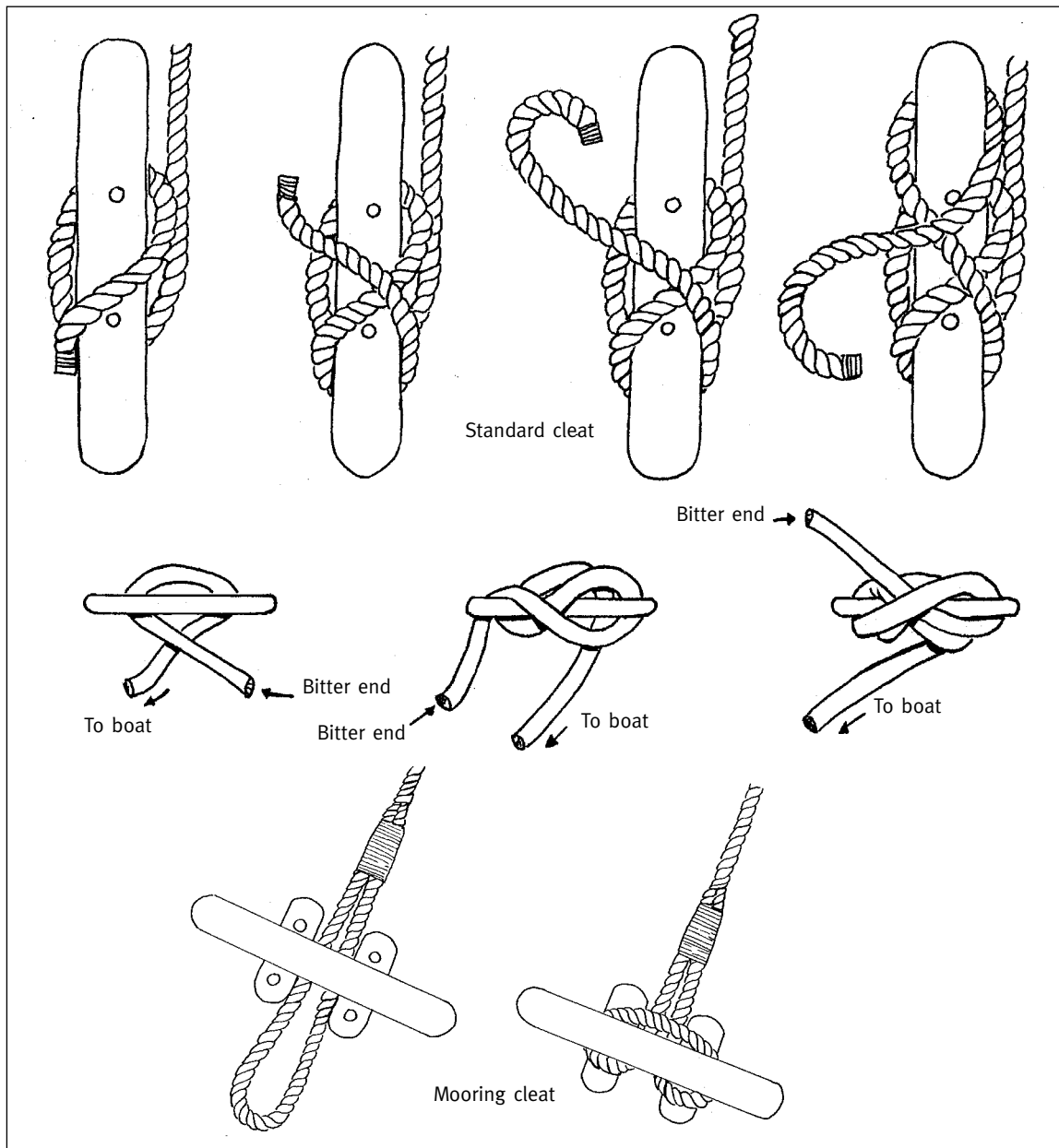
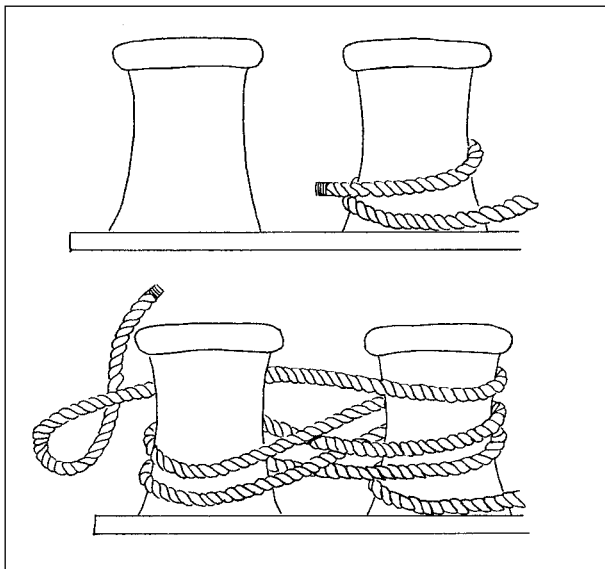
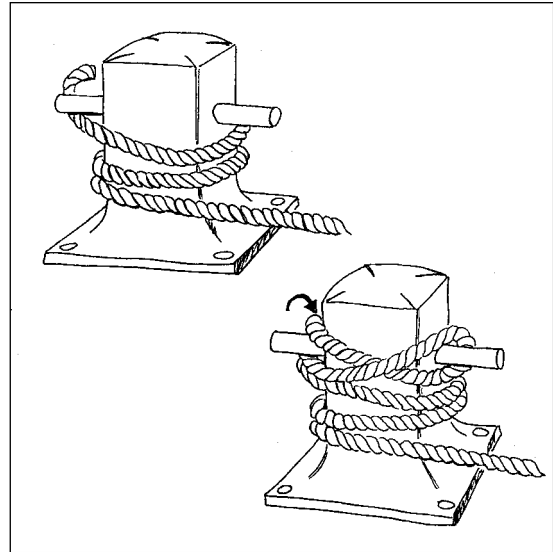

Figure 5.23: How to secure a line to a standard cleat

5.5.7.2 Securing a line to a Sampson post

A Sampson post is a special type of deck fitting sometimes used in place of a standard cleat. Begin by making a complete round turn around the base of the Sampson Post. Then, form several figure eights around the horns. Finish by taking a half hitch around each horn.

*Figure 5.24:
How to secure a line
to a Sampson post*



*Figure 5.25:
How to secure a line to a bitt*

5.5.7.3 Securing a line to a bitt

When making fast to bitts, make two round turns about the leading post, or two turns about both posts, before figure-eighting.

5.5.7.4 Securing a line to a railing

Sometimes, when other fittings are not available, it might be necessary to secure a line to a railing. When doing so, always try to secure your line as low as possible, near a point where the railing is bolted to the structure.

5.6 WIRE ROPE

5.6.1 Construction

Wire rope is made from multiwire strands laid in a spiral around a core of fibre or steel. It is always made larger, never smaller, than the nominal or rated diameter. For example, a 1-inch nominal diameter rope may vary between 1 and 13/64 inches.

The core is the foundation of a wire rope and affects its bending and loading characteristics. Wire ropes commonly used in fishing consist of fibre core (FC) or independent wire rope core (IWRC) constructions.

The design of a rope is also determined by strand construction (the number and arrangement of wires in each strand) and rope construction (the number and arrangement of strands in each rope).

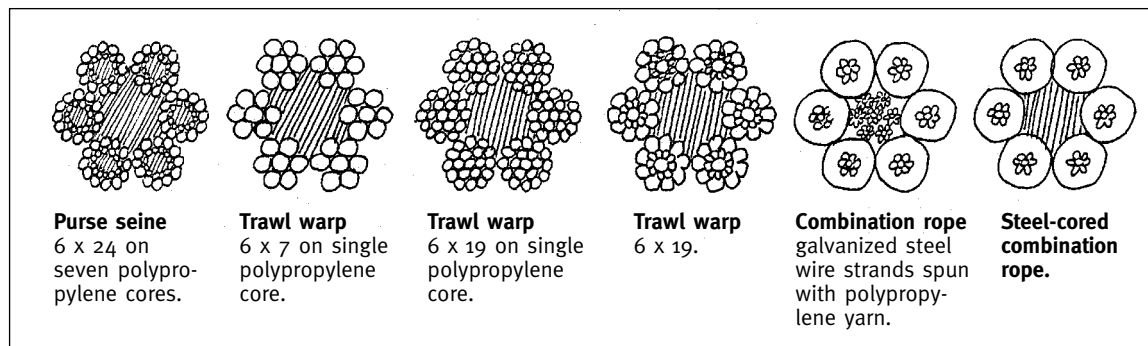

Figure 5.26: Wire rope – cross sections

Ropes are classified by the number of strands and the number of wires in each strand: 6 x 7, 6 x 19, 6 x 37, 8 x 19. However, these are nominal classifications. For example, the 6 x 19 class includes ropes made with strands containing from 15 to 26 wires. Ropes within the same class may have different working characteristics. To avoid mistakes in application it is important to order a specific construction, or to provide the supplier with a description of the intended use.

5.6.2 Wire rope lay

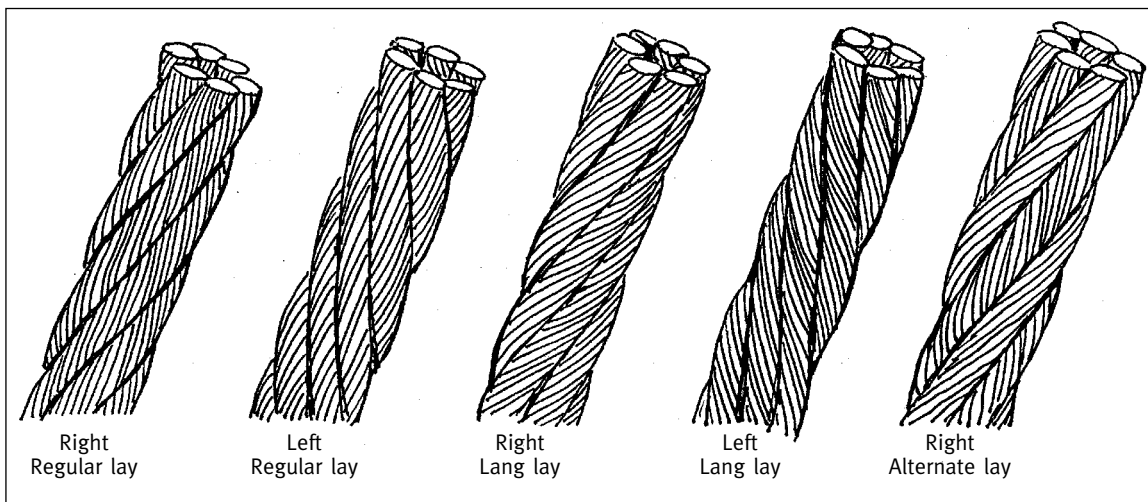
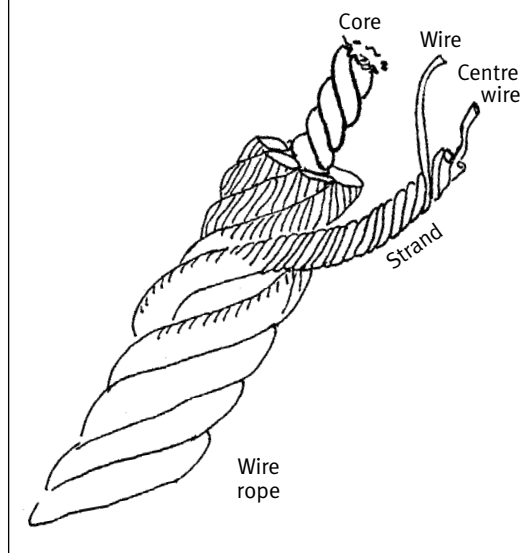

Figure 5.27: Wire rope lay

Regular lay: exterior wire strands are laid in the opposite direction to the core strands, and are parallel to the rope axis. Ropes with regular lay are easy to handle and have greater resistance to crushing than those with lang lay.

Lang lay: wires are laid in the same direction as the strands of the rope, and at an angle to the rope axis. Longer lengths of the individual wires are exposed, creating greater resistance to wear and improved flexibility. Lang lay ropes should only be used where both rope ends are 'fixed', and therefore should not be used with a swivel-type terminal.



5.6.3 Safety considerations

Wire rope is gradually consumed by wear and tear, and consideration must always be given to the gradual decrease in load-bearing capacity that occurs in a wire rope system. With the tremendous strains that occur during operations, it is essential to inspect the components in a wire rope system regularly and carefully.

Wire rope that has been worn or damaged develops "thorns" or "fishhooks," protruding strands of broken wire that stand up from the lay. Be careful: they can slash your hands. Always wear leather gloves around running wire.

5.6.3.1 Safe working loads

A safe working load (SWL) depends on the nominal strength of the rope and the efficiency of end attachments. There are two ways of attaching a rope: by forming an eye or by placing a fitting on the end. During fishing operations, wire rope may be pushed toward its

ultimate breaking strength. Be aware that two ropes rated with the same SWLs may differ substantially in ultimate breaking strength.

5.6.3.2 Bending stress

Ropes operating over sheaves or drums may be subject to fatigue if the sheave or drum diameters are too small, if loads are excessive, or if the sheaves or drums are worn. Reverse or S bends from one sheave to another cause greatly accelerated fatigue and should be avoided. Rope speed must also be considered: the higher the speed, the larger the sheave required.

The diameter of a sheave should never be less than 15 times the diameter of the rope. The larger the sheave and the slower the speed, the better. All manufacturers prescribe minimum sheave diameters, and their guaranteed breaking strengths and estimated safe working loads assume the use of minimum or larger sheave diameters and moderate working speeds. High speeds cause wear because of friction over the sheave, but the friction of the wires against one another causes even more wear than high speed.

Measuring grooves on a sheave

Under normal operating conditions, a groove tends to get deeper and narrower as it wears until replacement of the sheave becomes necessary. Excessive side wear may indicate misalignment in the system. A properly fitted sheave groove should support the rope over 135-150° of rope circumference. Field gauges are made to the nominal diameter of the rope PLUS one-half the allowable oversize. In an on-board inspection, when the gauge for worn grooves fits perfectly, the groove is at the minimum acceptable size.

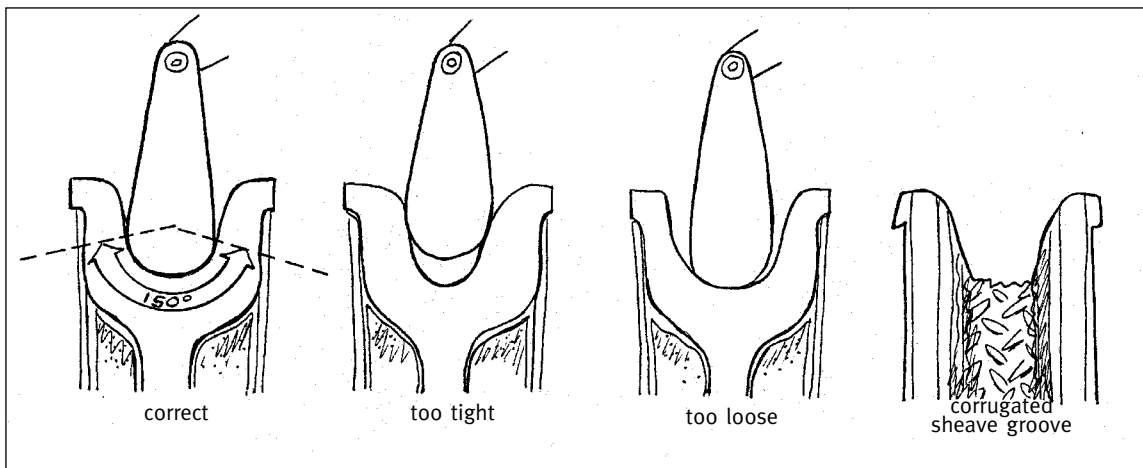

Figure 5.28: Measuring grooves on a sheave

A worn, corrugated sheave groove will quickly damage a new rope

Sheave inspection should also include the condition of bearings and shafts. A sheave rotated by hand should run true, without wobble. The groove should be round in relation to the shaft, and each sheave and shaft should be properly aligned.

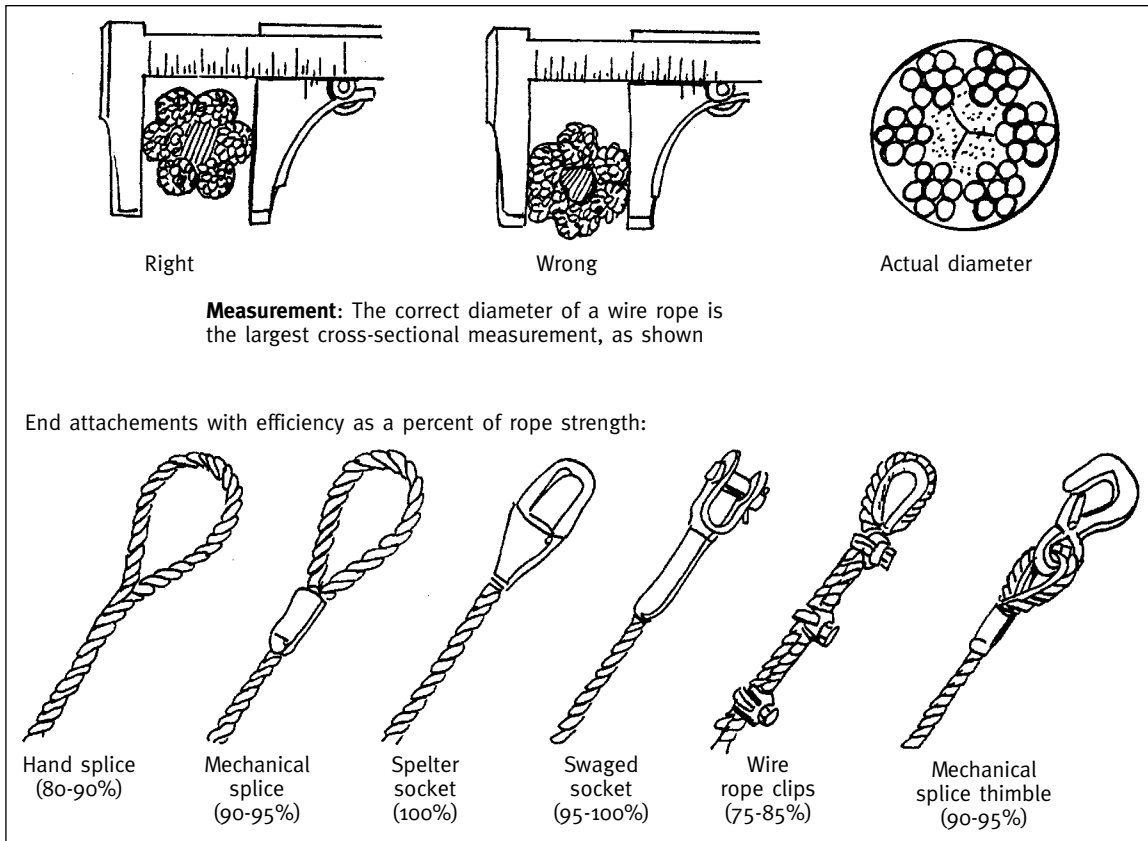

Figure 5.29: Using wire rope

Winding the lay

You must follow the lay when you wind the rope on a drum to ensure that the wraps hug together and form an even layer. Winding against the lay causes the wraps to spread so that the rope may cross over itself and become crushed or flattened.

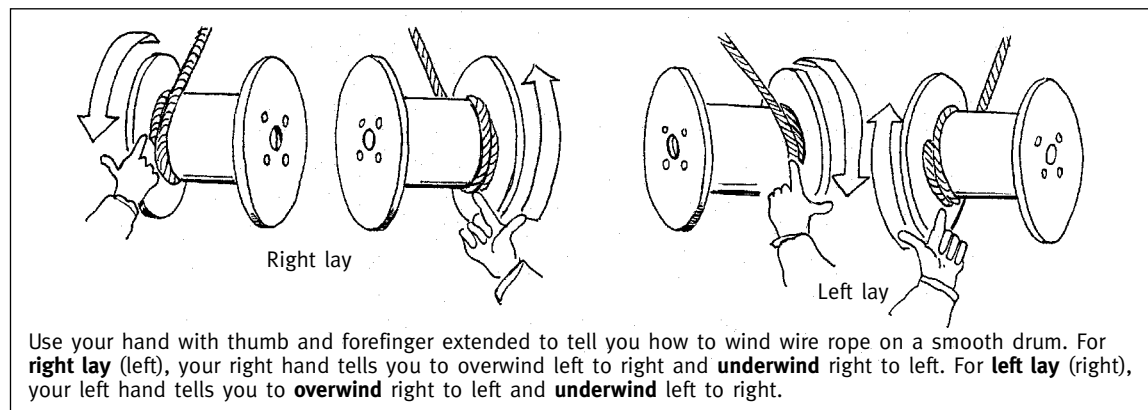

Figure 5.30: Winding with the lay

Extending rope life

Break-in: run new rope with light loads and controlled speeds to allow the wires and strands to adjust to each other.

If wear occurs near the ends, cut them off to remove the wear points.

Reverse the ends to bring less worn sections into areas where conditions are destructive. The result will be almost like getting new rope. Take care to avoid kinking or other damage in the process.

Clean and lubricate. Wire rope is a machine with moving parts, and factory lubricants don't last forever. Clean the surface so that new lubricant can penetrate to the core, but don't use lubrication-destroying solvents. Use a light-bodied penetrating lubricant applied by dripping, spraying or brushing. Apply it at the top of a bend over a sheave where the strands open up.

All wire and fittings should be kept lubricated. Various products are available for this purpose, such as "Lube-it," which is a clean, non-solvent and non-toxic lubricant.

5.6.3.3 Inspection

Wire rope should be inspected frequently and replaced if it shows signs of excessive wear such as:

- rust;
- broken strands of wire;
- kinks;
- overstretching;
- reduction in diameter;
- flattening.

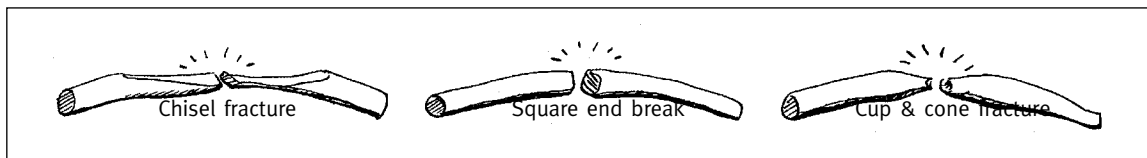

Figure 5.31: Inspection

Regular inspection determines when a rope can no longer be used safely, and helps pinpoint faults in equipment or operation that are causing costly and potentially dangerous rope wear.

Whenever significant numbers of wire breaks occur, or when obvious signs of damage appear, the rope ought to be replaced.

Chisel fractures mean the outside wires have been worn away by abrasion. When outside wires have been worn to one-half their original diameter, the wire has served its time and ought to be replaced.

Peening is distortion caused by pounding rather than abrasion. Excessive peening causes fatigue breaks and means there is a problem in your system that ought to be repaired.

Square-end breaks may occur even in relatively new ropes if there is excessive vibration or too much bending. Any sudden increase in such breaks means the rope ought to be replaced.

Cup and cone fractures are the result of overloads. Such breaks should not occur if your rope is operating under safe loads.

Reduction in diameter: a sharp reduction in diameter indicates core failure or internal corrosion. Either way, replacement is necessary. The line can be checked for wear with vernier calipers or a micrometer. You must know the original line diameter (when new), the present diameter at the wear location, and the diameter of a single wire strand. Subtract the measured rope diameter from the original diameter. If the difference is half the diameter of a single strand, the SWL of the rope is significantly reduced. If the difference is equal to or more than the diameter of a single strand, the rope should be replaced. Even if no damage to the wire rope is apparent, the line should be measured in about three locations more than one meter apart to determine the average diameter. Another method of judging the wire is to replace it if more than 5% of strands are broken over a length equal to three times the circumference.

If the outer wires of wire rope are worn to one half of their original diameter, the rope should be replaced. If the wire rope is hard, it should be removed from towing service.

Increased lay length: any increase in lay length (the distance a single wire travels in making one complete turn around the rope) should be viewed with concern. It may indicate core failure and means the rope should be replaced.

Corrosion of outside wires will produce accelerated wear because the wires will no longer tolerate bending. Internal corrosion means the rope is unsafe and should be replaced. Corrosion is a particular problem for trawlers, which use wire rope extensively in the highly corrosive saltwater environment.

Accidental damage caused by the rope jumping a sheave or being struck by a falling weight calls for close inspection and constant checking. It will be impossible to determine the remaining strength, and replacement may be required.

5.7 WORKING WITH ROPES, LINES AND WIRES

Ropes, lines and wires are of paramount importance in SAR operations. No matter what kind of rescue you are to perform, in the vast majority of cases, you will have to use a rope, a line or a wire at some point in the process. Ropes, lines and wires are thus very important tools for everybody involved in search and rescue. However, just like for most tools, inappropriate usage can be time-wasting, if not simply dangerous. This section describes some ways to work with ropes, lines and wires. This knowledge should help you to make better use of these tools.

5.7.1 Working with ropes

General precautions:

- All ropes should be kept dry and clean, away from chemicals, acids, strong alkali, drying oil, paint and fumes to avoid damage and strength reductions;
- Never overload a rope;
- A frozen rope should be allowed to thaw and dry before re-use;
- A rope should never be dragged over the ground or over sharp objects. Dragging a rope over another will damage both;
- Avoid abrupt bends if possible, as they weaken rope strength considerably. Pad all sharp corners;
- Synthetic ropes can be slippery when wet or new. Use additional care when handling them or tying knots;
- Store ropes in a dry cool place with good ventilation. Hang them in loose coils well above the floor or deck;
- Dry and clean wet ropes before storing. Allow them to dry naturally, as too much heat will make the fibres brittle;
- Keep ropes away from all sources of heat;
- Ropes should be kept out of direct sunlight. When not in use, they should be covered by a canvas or other shield, or, if the vessel is engaged on a long trip, stowed away;
- When putting a splice in a twisted synthetic fibre rope, use at least four full tucks. Be sure to seal any tail ends of strands by whipping. Do not use tape for that purpose;
- Before putting any ropes or line into any stress, carefully inspect a rope, both internally and externally (see next section for rope inspection information).

5.7.1.1 Rope inspection

Ropes should be checked regularly. The main points to check are external wear and cutting, internal wear between the strands and deterioration of the fibres.

- Check the entire length of the rope for breaks on the outside fibres, cuts, burns, signs of abrasion, unlaying and reduction in diameter; each represents a loss of strength;
- Untwist the strands carefully to observe internal condition of the rope. It should be bright and clean. Excessive wear of interior fibres is often indicated by the accumulation of a powder-like dust;
- Pull out a couple of long fibres from the end of the rope and try to break them. If they break easily, replace the rope;
- When you discover a weak spot, cut out the portion and splice the rope. Use a short splice, unless the rope is to be run through a pulley;
- If a rope is found unfit for use, it should be destroyed or cut into short lengths;
- Don't take chances. If you have any doubt as to whether or not a rope is fit for use, replace it immediately.

5.7.1.2 Coiling and faking a rope

To avoid kinks, twisted ropes should be coiled in a clockwise direction (or in the direction of the lay of the rope) and uncoiled in a counterclockwise direction. Another method is to fake out the line figure-eight fashion. This method avoids putting twists in the line in either direction and minimizes the risk of kinking.

Braided ropes have no inherent twists and are thus far more resistant to kinking. Even if kinks develop, they cannot develop into knuckles. The best way to prepare braided ropes for deck stowage is with the figure-eight method. The rope can be faked either flat on the deck or figure-eight style, vertically around bulkhead cleats. Hand-coiling should be avoided since it will put turns in the rope that are likely to develop into kinks during paying-out.

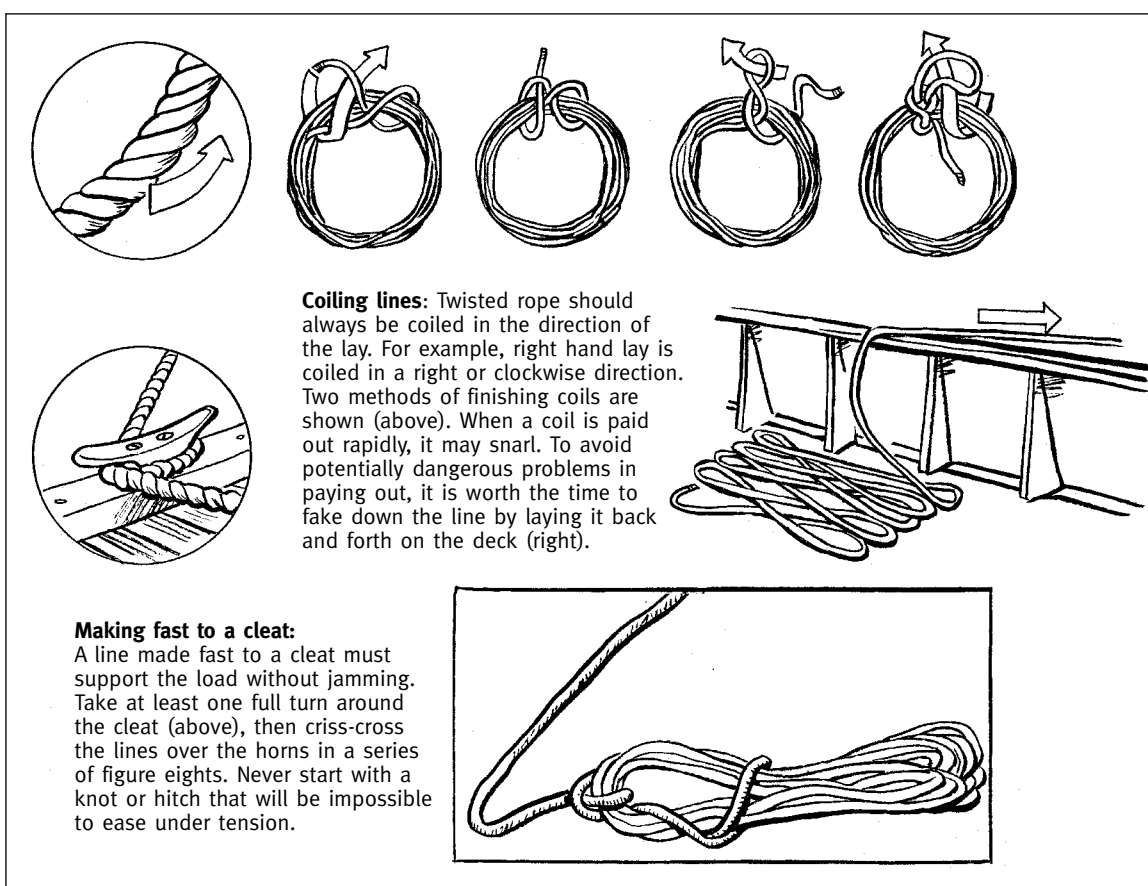

Figure 5.32: Coiling and faking a rope

5.7.1.3 Cutting a rope

To prevent a rope from unraveling during cutting, follow the following procedure. Tape the rope around its circumference. Cut in the middle of the tape so both ends will be taped once cut. When cutting synthetic lines, use a hot knife. This will melt and fuse the ends. If a hot knife is used, taping is optional. Natural fibres will not fuse with heat. Use proper whipping techniques to prevent unraveling once the cut is made.

5.7.1.4 Safe working loads

The strength of a rope or wire depends mostly on its diameter and composition. The following table lists the strengths of different sizes and kinds of ropes.

Table 5.1: Safe working loads and breaking strength of various ropes

Recommended shackles and hooks to be used with Coast Guard authorized towline

Shackles			Hooks		Nylon (double braided) Towline					
Size inches	BS pounds	SWL pounds	Size length	BS pounds	SWL pounds	Size inches	BS pounds	SWL by line condition		
								Good	Average	Poor
5/8	12,000	3,000	5 5/8	12,000	3,000	2	9,000	3,000	2,250	1,500
1/2	24,000	6,000	6 15/16	24,000	6,000	2 1/2	14,062	4,687	3,515	2,343
5/8	39,000	9,750	8 15/32	36,000	9,000	2 3/4	17,010	5,670	4,252	2,835
						3	20,250	6,750	5,062	3,375

Minimum breaking strengths and safe working loads for natural and synthetic lines

Manila						Nylon (double braided)			
Size diam.	Size cir.	BS pounds	SWL by line condition			BS pounds	SWL by line condition		
			Good	Average	Poor		Good	Average	Poor
3/8	2	3,600	720	360	240	9,000	3,000	2,250	1,500
13/16	2 1/2	5,625	1,123	562	375	14,062	4,687	3,515	2,343
7/8	2 3/4	6,804	1,360	680	454	17,010	5,670	4,252	2,835
1	3	8,100	1,620	810	540	20,250	6,750	5,062	3,375

Polypropylene/Polyethylene						Polyester (Dacron)			
Size diam.	Size cir.	BS pounds	SWL by line condition			BS pounds	SWL by line condition		
			Good	Average	Poor		Good	Average	Poor
5/8	2	5,040	1,008	840	630	7,200	2,400	1,800	1,200
13/16	2 1/2	7,875	1,575	1,312	840	11,250	3,750	2,812	1,875
7/8	2 3/4	9,525	1,905	1,588	1,190	13,608	4,536	3,402	2,268
1	3	11,340	2,268	1,890	1,417	16,200	5,400	4,050	2,700

It is important to note that working loads are given for ropes that are in good condition (and with appropriate splices if applicable), in non-critical applications and under normal service conditions. Working loads are based on a percentage of the approximate breaking strength of new and unused ropes. Normal working loads do not cover dynamic conditions such as shock loads or sustained loads. Dynamic loading occurs any time a load is picked up, stopped, moved or swung. The more rapidly or suddenly these actions occur, the greater the dynamic loading will be. Under these circumstances, the force applied to the rope can be several times greater than expected, and lower working loads should be used to compensate. Dynamic effects are greater on ropes that have low elasticity. In addition, when life, limb or valuable property depend on the strength of a rope (as in climbing or towing for example), lower working loads must also be used to increase the margin of safety.

5.7.2 Working with wires

Handling wire

A coil of wire must not be opened in the same manner as a coil of rope, or a multitude of kinks will be the result. Instead, it should be unrolled in the opposite direction to the one in which it was coiled. Small coils can be rolled along the deck in the same manner as a hose is unrolled.

5.7.2.1 Taking a wire rope from a reel

The reel must be mounted on a shaft or turn-table so it is capable of rotating, or rolled along the ground as the rope is paid out. Never pull rope over the flange of a stationary reel.

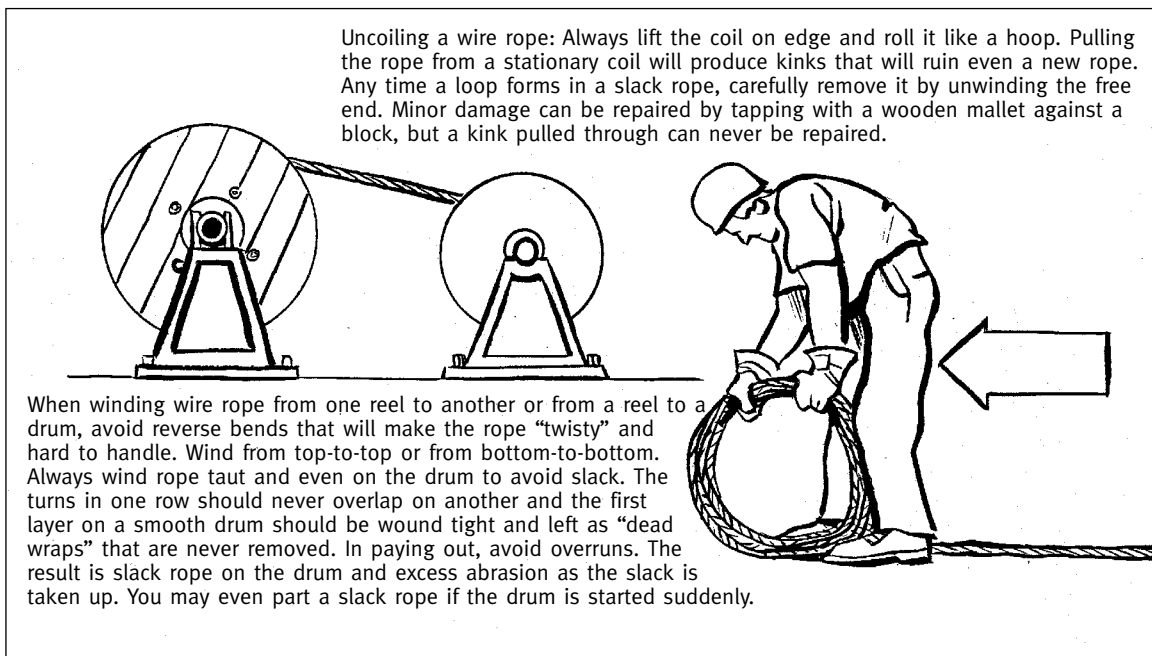

Figure 5.33: Winding wire rope on drums and uncoiling a wire rope

5.7.2.2 Storage

Wire ropes should be cleaned, lubricated, wound on a reel and stored indoors and away from corrosive atmospheres.

5.7.2.3 Seizing and cutting

Place seizings securely on each side of the point where a cut is to be made to prevent the wire rope strands from exploding or flying apart. The seizing should be tight enough so that no strands are even slightly displaced. While wire is normally prescribed, tape is often the fisherman's seizing.

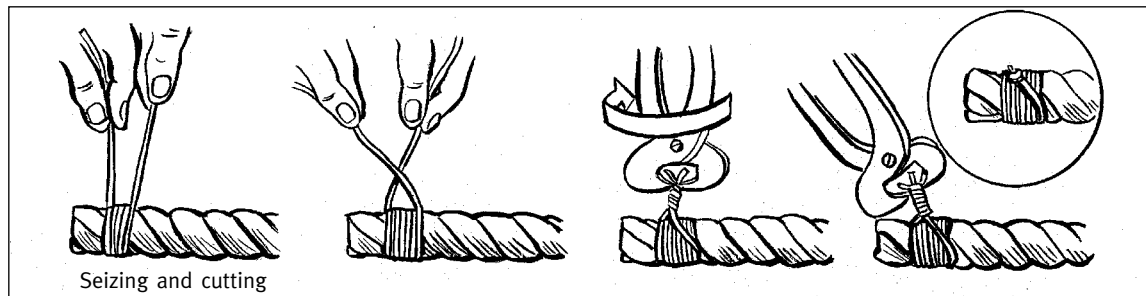

Figure 5.34: Seizing and cutting

5.7.2.4 Accidents involving use of mooring wires and reels

There are two practices involving these items that cause frequent accidents. The first is using a mooring wire directly from a reel, and the second is coiling this wire on deck while it is being rendered from a nearby cleat or bitts to be used as a check wire, a spring, or in lowering some heavy object.

Using a wire directly from the reel can cause the frame to be torn from the deck. This has occurred when the wire fouled the reel; the result can be not only serious damage, but injury and even death for crewmembers. In a recent case of this practice, the reel on a small towing vessel was fouled by the wire and no slack was available. The vessel heeled over, became swamped and sank, drowning the crew.

These practices are both unseamanlike and extremely dangerous. When a wire coiled close to the cleat or bitts from which it is being rendered suddenly becomes unmanageable and runs out of control, crewmembers can become caught in the loose coils and seriously injured or even killed.

Sufficient wire should be taken from the reel for the purpose intended. Remove all the wire from the reel if necessary, and fake it on deck well clear of the working area. If possible, a second crewmember should be available to feed the slack to the crewmember rendering the wire around the bitts or cleat. Before the bight is taken, the second crewmember should ensure that there are sufficient turns on the bitts or cleat for the purpose without danger of jamming.

5.7.2.5 Working safely

Never stand in a bight of rope or wire. If it tightens suddenly, a serious injury may follow.

Never guide wire with your hands or feet.

Always wear heavy gloves or mitts when handling wire rope.

When making a wire rope fast to the bitts, always lash the top turns down, to prevent the wire from springing off the bitts.

CHAPTER 6 – NAVIGATION SAFETY

6.1	Collision regulations	6-3
6.1.1	General	6-3
6.1.2	Responsibility	6-3
6.1.3	Lookout	6-3
6.1.4	Safe speed	6-4
6.1.5	Conduct of vessels in sight of one another	6-5
6.1.5.1	Meeting, crossing and overtaking	6-6
6.1.5.2	Sailboats and special situations	6-7
6.1.6	Conduct of vessels in restricted visibility	6-7
6.2	Lookout procedures	6-7
6.2.1	General	6-7
6.2.2	Requirement	6-8
6.2.3	Assignment and station	6-8
6.2.4	Guidelines	6-8
6.2.5	Lookout positioning	6-9
6.2.6	Object identification	6-9
6.2.7	Relative bearings	6-9
6.2.8	Position angle	6-10
6.2.9	Distance	6-10
6.2.10	Making reports	6-11
6.2.11	Scanning	6-11
6.2.12	Scanning procedure	6-11
6.2.13	Night scanning	6-12
6.2.14	Fog scanning	6-12
6.2.15	Night lookout watch	6-12
6.2.15.1	Dark adaptation	6-12
6.2.15.2	Scanning	6-12
6.2.16	Helm watch	6-13
6.2.16.1	Guidelines	6-13

- 6.2.17 Towing watch 6-13
 - 6.2.17.1 General 6-13
 - 6.2.17.2 Guidelines 6-13
 - 6.2.17.3 Observed danger 6-14
 - 6.2.17.4 Maintaining watch 6-14
- 6.2.18 Anchor watch 6-14
 - 6.2.18.1 Guidelines 6-14
 - 6.2.18.2 Check for chafing 6-15
 - 6.2.18.3 Check for dragging 6-15
 - 6.2.18.4 Check your position 6-15
- 6.3 Aids to navigation 6-16**
 - 6.3.1 General 6-16
 - 6.3.2 Buoys 6-16
 - 6.3.2.1 Lateral buoys 6-16
 - 6.3.2.2 Cardinal buoys 6-17
 - 6.3.2.3 Special purpose buoys 6-19
 - 6.3.3 Lights, leading lights, sector lights and direction lights 6-20
 - 6.3.3.1 Lights 6-20
 - 6.3.3.2 Leading lights (also known as range lights) 6-20
 - 6.3.3.3 Sector lights 6-20
 - 6.3.3.4 Direction lights 6-20

6 NAVIGATION SAFETY

6.1 COLLISION REGULATIONS

6.1.1 General

Navigation, like vehicle driving, has its set of rules of the “road.” The problem is that not everybody using the “road” knows the rules. As an SAR crewmember, you will probably have to manoeuvre at high speed both among people that are familiar with the rules and among people that know nothing about them. To avoid accidents, you must know how to navigate with these people. Also, everybody expects SAR responders to behave in a professional manner. Knowing the rules is part of a professional attitude. Lastly, the legal consequences of not knowing the rules could be really serious if you were to be involved in a collision.

For all these good reasons, let’s take a few pages of this manual to look at the collision regulations: the rules of the road. You **MUST** know all the rules presented in the following pages, and there is no magical way to learn them. This is an extremely difficult subject, but always remember that your safety and the safety of other vessels may depend on your knowledge of these rules. Please take the time to study them.

On the Internet (Transport Canada), you will find the current Collision Regulations. Although it is paramount to know every single rule presented in the regulations, the following pages deal with those that are the most relevant when it comes to SAR operations with small units.

6.1.2 Responsibility

Rule 2 of the collision regulations states:

- a) *Nothing in these Rules shall exonerate any vessel, or the owner, master or crew thereof, from the consequences of any neglect to comply with these Rules or of the neglect of any precaution which may be required by the ordinary practice of seamen, or by the special circumstance of the case.*
- b) *In construing and complying with these Rules, due regard shall be had to all dangers of navigation and collision and to any special circumstances, including the limitation of the vessel involved, which may make a departure from these Rules necessary to avoid immediate danger.*

Simply put, then:

- If you are involved in a collision and you did not follow the Rules, you are 100% responsible;
- The Rules are not there to replace good judgment and practice of good seamanship. You should not put your vessel in any danger by blindly following the Rules. You must consider all factors pertaining to navigation (water depth, wind, traffic, current, manoeuvrability of your vessel, etc.) when complying with the Rules.

6.1.3 Lookout

Rule 5 of the collision regulations states:

Every vessel shall at all times maintain a proper lookout by sight and hearing as well as by all available means appropriate in the prevailing circumstances and conditions so as to make a full appraisal of the situation and of the risk of collision.

In other words, you should always have at least one person designated as a lookout at all times when you are on board. Under no circumstances should your vessel be underway without someone on lookout duty. This rule may seem quite obvious, but be remember that on an SAR case, everyone on board may be doing something (looking at charts, taking care of casualties, talking on the radio or cellular phone, etc.), and the lookout position may be overlooked.

6.1.4 Safe speed

Rule 6 of the collision regulations states:

Safe Speed – International

Every vessel shall at all times proceed at a safe speed so that she can take proper and effective action to avoid collision and be stopped within a distance appropriate to the prevailing circumstances and conditions.

In other words, the speed at which you navigate must be adapted to the prevailing circumstances and conditions. For example, a safe speed in plain daylight may not be safe at night or when visibility is restricted by fog. Coxswains must use good judgment to determine safe speed. In low visibility, it is good practice to be able to stop your vessel in one-half the visibility distance. The rules go on to provide a list of the factors that should be taken into account in determining a safe speed.

By all vessels:

- (i) the state of visibility;*
- (ii) the traffic density including concentrations of fishing vessels or any other vessels;*
- (iii) the manoeuvrability of the vessel with special reference to stopping distance and turning ability in the prevailing conditions;*
- (iv) at night, the presence of background light such as from shore lights or from backscatter of her own lights;*
- (v) the state of wind, sea and current, and the proximity of navigational hazards;*
- (vi) the draught in relation to the available depth of water.*

In addition to the international rules, some modifications apply in Canadian waters:

Safe speed – Canadian modifications

- (c) In the Canadian waters of a roadstead, harbour, river, lake or inland waterway, every vessel passing another vessel or work that includes a dredge, tow, grounded vessel or wreck shall proceed with caution at a speed that will not adversely affect the vessel or work being passed, and shall comply with any relevant instruction or direction contained in any Notice to Mariners or Notice to Shipping.*
- (d) For the purpose of paragraph (c), where it cannot be determined with certainty that a passing vessel will not adversely affect another vessel or work described in that paragraph, the passing vessel shall proceed with caution at the minimum speed at which she can be kept on her course.*

6.1.5 Conduct of vessels in sight of one another

Traffic on roads and highways would be chaos without laws to regulate the right of way. On the water, where movement is less restricted, rules of the road are even more important. This is particularly true of crossing situations.

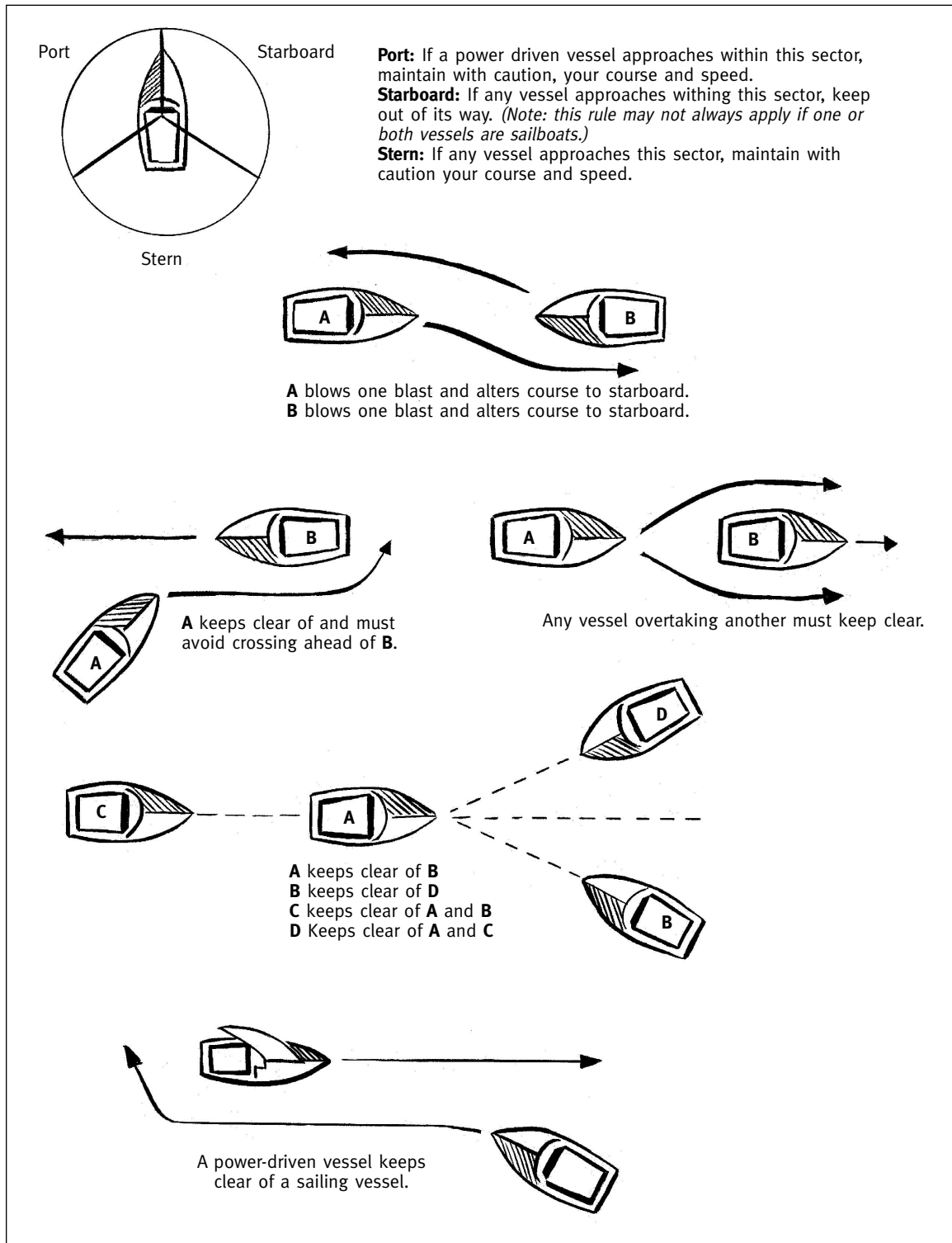

Figure 6.1: Meeting situations

6.1.5.1 Meeting, Crossing and Overtaking

There are three situations which may lead to boat collisions: meeting head on, crossing each other's paths, and one vessel overtaking and passing another.

Meeting

Neither boat has the right of way, and each should swing right, then straighten course to pass left side to left side, as vehicles on the road do. Meeting situations would almost never involve risk of collision if all boats adopted this practice. Unfortunately, they don't.

If you must change your boat's heading to avoid collision, then give one blast on your horn to indicate you are changing course to your right, or two blasts to signal that you are changing course to your left. Note that if your boat and the other craft are on the left side of the channel, it is better to pass right side to right side than to try to exchange positions

Crossing

When two boats are approaching each other at right angles, they may be in danger of colliding with each other. To help determine whether the two vessels are on a collision course, visually align some vertical part of your boat – a flagstaff or antenna, for example – with any point on the other boat. If this bearing remains the same over a period of time, then a danger of collision exists.

When boats are in a crossing situation, the boat on the right has the right of way. This does not mean that the skipper can do as he or she pleases. The skipper is required to maintain course and speed, so that the other boat operators can calculate the best method of keeping clear. Both should use the proper manoeuvring and warning signals. Very few operators do.

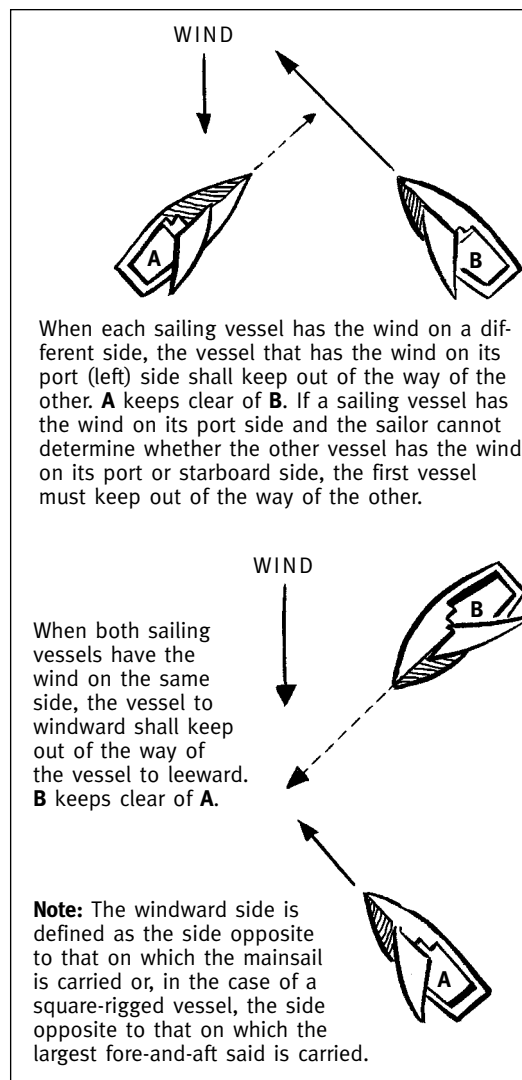

Figure 6.2: Operating rules for sailboats

Overtaking

The boat being overtaken always has the right of way, and the overtaking boat should take the following steps if it wishes to pass:

- Swing clear of the wake of the overtaken boat, preferably so that the overtaker will pass as an overtaking vehicle does, on the slower vessel's left side;
- Both should use the proper manoeuvring and warning signals;
- Pass safely, the passing boat must be clear ahead of the other vessel before the passing situation is ended.

Note: Actual rules for crossing situations can be found in Section II of the Collision Regulation booklet.

6.1.5.2 Sailboats and special situations

As a general rule, sailing craft have the right of way over engine-driven vessels, but it is important to remember the exceptions:

- A sailboat overtaking a powerboat does not have the right of way (the overtaken vessel always has the right of way);
- A sailboat does not have the right of way over a commercial fishing boat while it is fishing; no small vessel, power or sail, has the right of way over a large vessel in a narrow channel, when the large vessel cannot safely leave the channel.

In fact, with respect to large commercial craft (tugs, freighters, ferries, etc.) small pleasure boats would do best to stay completely clear of them. Large ships and tugs with tows cannot manoeuvre easily or stop quickly. Right of way aside, it is very foolish to approach large ships closely. This applies even when a large vessel is tied to a pier. Her propeller may still turn over, and it can reduce a small boat to kindling in the wink of an eye.

When passing commercial docks and piers, be alert for one long blast of a ship's whistle, which means that a vessel is about to pull clear from a slip. Three blasts of a whistle mean that ship's engines are in reverse and that she is beginning to back up.

6.1.6 Conduct of vessels in restricted visibility

In restricted visibility, every vessel shall proceed at a safe speed adapted to the prevailing circumstances and conditions of restricted visibility. Additional sound signals tell other boats what you are up to before your boat is visible. Besides using these signals, every skipper must operate his or her boat so that she can be stopped in order to avoid collision. A rule of the thumb suggests that the skipper should operate the boat so that she can be stopped in one-half the visibility distance. In addition to using sound signals, all vessels should show proper lights and shapes. Section III of the Collision Regulation covers all these topics. The reader is encouraged to read this section carefully.

6.2 LOOKOUT PROCEDURES

6.2.1 General

Under the direction of the coxswain, crewmembers are assigned various watches, which are described in this section.

6.2.2 Requirement

The Collision Regulations state that “Every vessel shall at all times maintain a proper lookout by sight and hearing as well as by all available means appropriate in the prevailing circumstances and conditions so as to make a full appraisal of the situation and of the risk of collision.”

6.2.3 Assignment and station

Coxswains must assign and station lookouts properly in order to comply with the requirement noted above. While the boat is underway, lookouts must report to the coxswain everything seen, smelled, or heard that may endanger the boat or may indicate a situation to investigate (e.g., distress, law enforcement or pollution). Some examples are:

- ships;
- land;
- obstructions;
- lights;
- buoys;
- beacons;
- discoloured water;
- reefs;
- fog signals;
- anything that could affect safe navigation.

Note: It is most important for the coxswain to consider the experience level and abilities of individual crewmembers when making assignments. In the past, the inappropriate assignment of crew duties has contributed to mishaps resulting in fatalities.

6.2.4 Guidelines

Use the following guidelines to stand a proper lookout watch:

- Remain alert and give full attention to your assigned duty;
- Remain at your station until you are relieved;
- Do not distract yourself or others with excessive conversation, (however, some conversation among crewmembers may be beneficial in reducing fatigue and maintaining alertness);
- Speak loudly and distinctly when making a report;
- If you cannot positively identify the object sighted, smelled or heard, report what you think at that moment;
- Repeat your report until it is acknowledged by the coxswain;
- When conditions impair your ability to see, smell, or hear, report the condition so that the coxswain can take corrective action;
- Report everything you see, including floating material, even if you have to report it several times;
- Make certain you understand your duties. If you do not understand your duties, ask for more information.

6.2.5 Lookout positioning

Lookouts must be posted by the coxswain so that they have the best possible chance of seeing and hearing an approaching vessel or searching for an object in the water. The coxswain should use the following steps when positioning lookouts:

- Choose a boat speed that enables lookouts to effectively and safely perform their duties;
- Position lookouts so they can effectively and safely perform their duties under the operating conditions (e.g., restricted visibility, boat speed, sea state, weather);
- During periods of rain, sleet, and snow or when taking spray over the bow, select lookout positions that minimize impairment of vision;
- During a search, post two lookouts when possible. Lookouts should be positioned on each side of the vessel so that each can scan a sector from dead ahead to directly aft;
- Select a stable location that will not place the lookouts in danger of being blown or swept overboard.

6.2.6 Object identification

Lookouts must report what they see, smell or hear with as much detail as possible. Object type is immediately important (vessel, buoy, breaking waves), but additional details may help the coxswain in decision making. Some obvious characteristics of objects include colour, shape and size.

At night, lookouts must identify the colour of all lights. This is the specific reason why all boat crewmembers must have normal colour vision.

6.2.7 Relative bearings

Lookouts make reports using relative bearings only. This means that the bearings are measured with reference to the vessel's heading, or to the fore and aft line of the boat's keel. These bearings run clockwise from zero degrees (000°) or dead ahead, through one-eight-zero degrees (180°) or dead astern, around to three-six-zero degrees (360°) or dead ahead again.

The following steps are important in reporting relative bearings:

- Study figure 6.3 on major reference points of relative bearings. Picture in your mind the complete circle of relative bearings around your boat in 10-degree increments;
- Bearings are always reported in three digits and distinctly spoken digit by digit. To ensure one number is not mistaken for another, the following pronunciation is required.

Numeral	Spoken as	Numeral	Spoken as
Zero (0)	ZERO	Five (5)	FI-YIV
One (1)	WUN	Six (6)	SIX
Two (2)	TOO	Seven (7)	SEVEN
Three (3)	THUH-REE	Eight (8)	ATE
Four (4)	FO-WER	Nine (9)	NINER

The following are examples of how to report bearings:

Bearing	Reported as
000°	ZERO ZERO ZERO
010°	ZERO WUN ZERO
045°	ZERO FO-WER FI-YIV
090°	ZERO NINER ZERO
135°	WUN THUH-REE FI-YIV
180°	WUN ATE ZERO
225°	TOO TOO FI-YIV
260°	TOO SIX ZERO
270°	TOO SEVEN ZERO
315°	THUH-REE ONE FI-YIV

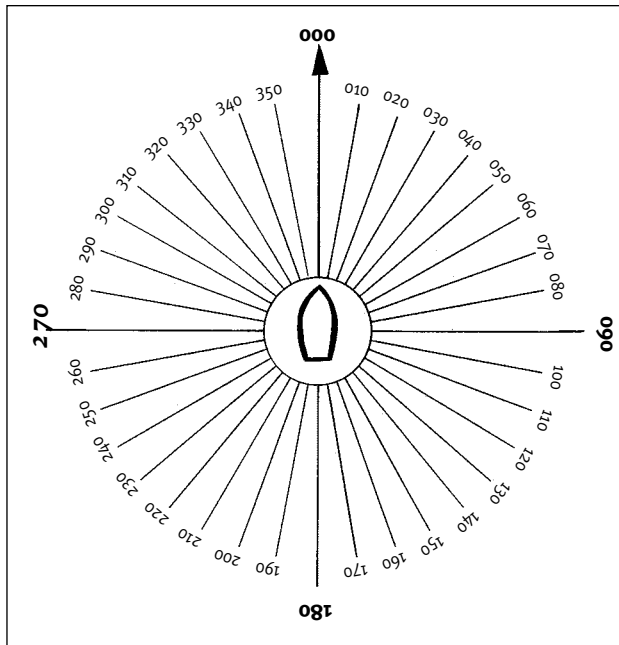

Figure 6.3: Relative bearing circle

A modified application of this method is by using port and starboard with degrees. For example: Starboard 30° or Port 30° (from dead ahead).

An easy method of informing the coxswain of the sighted object is by using the “clock method” of reporting. The lookout must imagine the vessel in the centre of a clock face.

The bow will be at 12 o'clock and the stern at 6 o'clock. Sightings would be reported as an “object at 9 o'clock.” This would inform the vessel coxswain to turn 90° to port. The lookout would continue reporting the position until the vessel coxswain has the object in sight.

The crew must be briefed on the method being used.

6.2.8 Position angle

Objects in the sky are located by their relative bearing and position angle. The position angle of an aircraft is its height in degrees above the horizon as seen from the boat. The horizon is 0° and directly overhead is 90°. The position angle can never be more than 90°. Position angles are reported in one or two digits and the words “position angle” are always spoken before the numerals.

6.2.9 Distance

Report distances in nautical miles or fractions of nautical miles. Knowing the distance to the horizon, land, or other reference point will help estimate distance. By dividing the distance from you to your reference point, you can estimate the distance to another object. Ranges in nautical miles are reported digit by digit.

6.2.10 Making reports

When making reports, the lookout names or describes the object sighted, the direction (in relative degrees) and the range to the object in nautical miles or parts of miles ($\frac{1}{4}$, $\frac{1}{2}$). Give reports in the following format:

- object name or description;
- bearing;
- range.

For example:

- discoloured water on a bearing of 340° relative to the bow of the boat and at a distance of 0.5 nautical miles;
- REPORTED AS: "Discoloured water Bearing THUH-REE FO-WER ZERO, Range ZERO DECIMAL FI-YIV;"
- an aircraft bearing 280° relative to the bow of the ship, 30° above the horizon, and at a distance of 2 nautical miles;
- REPORTED AS: "Aircraft TOO ATE ZERO, Position Angle THUH- REE ZERO, Range TOO."

6.2.11 Scanning

The lookout's method of eye search is called scanning. Scanning is a step-by-step method of visually searching for objects. Good scanning techniques will ensure that objects are not missed. Scanning also reduces eye fatigue. Development of a systematic scanning technique is important. There are two common scanning methods:

- left to right and back again;
- top to bottom and bottom to top.

In either case, move your eyes in increments. This creates overlaps in your field of vision and fewer objects will be missed.

6.2.12 Scanning procedure

- When looking for an object, scan the sky, sea and horizon slowly and regularly. Scan from left to right and back again or from top to bottom and bottom to top;
- When scanning, do not look directly at the horizon; look above it. Move your head from side to side and keep your eyes fixed. This will give any stationary objects in your field of vision the appearance of moving and make them easier to see;
- One technique is to scan in small steps of about 10 degrees and have them slightly overlap as you move across your field of view;
- Fatigue, boredom and environmental conditions affect scanning. For example, after prolonged scanning, with little or no contrast, your eyes develop a tendency to focus short of where you think you are looking. To prevent this problem, periodically focus on a close object such as whitecaps or the bow of the boat.

6.2.13 Night scanning

When binoculars are used for night scanning, hold them straight forward and shift your line of sight in a circular path around the inside of the binocular field. When you think you see an object, look all around it, not at it. The chances are it will appear in dim outline. Using binoculars at night on a stable platform increases your range of vision significantly. However, objects will not appear in clear detail.

6.2.14 Fog scanning

Fog lookouts scan slowly and rely on their ears. The best position for a fog lookout is where sight and hearing receive no interference from radios, conversation, or other distractions. Usually the bow is best, if conditions permit.

6.2.15 Night lookout watch

Although the duties for day and night lookout watches are the same, safety and caution during night watches are especially important. Your eyes respond much more slowly at night and pick up moving objects more readily than fixed objects. It takes about 30 minutes for your eyes to become accustomed to the limited light available at night.

The guidelines for lookout watches also apply for night lookout watches.

Note: Night vision means that your eyes receive and interpret a different type of light than the one that exists during daylight.

6.2.15.1 Dark adaptation

Dark adaptation is the improvement of vision in dim light. It is very difficult to see colours at night. Most objects are seen in various shades of gray. Although dark adaptation requires at least 30 minutes, a bright light will destroy night vision in a fraction of a second. In this brief period, the eyes readjust themselves to daylight conditions and the process of dark adaptation must begin all over again.

Note: Avoid looking at bright lights during nighttime operations. When a light must be used, use a red light.

6.2.15.2 Scanning

Scan the sky, sea, and horizon slowly and regularly when looking for an object. Scan from left to right and back again or from top to bottom and from bottom to top.

6.2.16 Helm watch

The helm watch or helmsman is responsible for the following:

- safely steering the boat;
- maintaining a course;
- carrying out all helm commands given by the coxswain.

The helm watch can be carried out by the coxswain or by any designated crewmember. All crewmembers should learn to steer and control the boat. They must learn to use both the primary steering system and the emergency steering system (if present), to ensure safe operations of the boat under normal and abnormal conditions.

6.2.16.1 Guidelines

When a boat uses a helmsman, there are several guidelines for the helm watch:

- Check with the coxswain for any special instructions and for the course you will steer;
- Repeat all commands given by the coxswain;
- Execute all commands given by the coxswain;
- Maintain a given course within 5°;
- Remain at the helm until properly relieved;
- Execute manoeuvres only when expressly ordered. However, minor changes in heading to avoid debris, which could damage propeller or rudders, are essential;
- Operate the emergency tiller (if present) during loss of steering;
- Properly inform relief of all pertinent information.

6.2.17 Towing watch

6.2.17.1 General

A towing watch is normally performed aft on the boat. The primary duty of the towing watch is to keep the towline and the boat being towed under constant observation. (For more information on towing procedures, see Chapter 10.)

6.2.17.2 Guidelines

The guidelines for standing this watch are as follows:

- Note how the tow is riding (e.g., in step, listing or veering);
- Report any unusual conditions to the coxswain;
- Ensure chafing gear is riding in place;
- Adjust the scope of the towline upon command of the coxswain;
- Report any equipment failure or problems observed to the coxswain immediately;
- Keep deck space area clear of unnecessary gear and people;
- Stay clear of the immediate area around the towline in case of possible line snap back;
- Know when and how to do an emergency breakaway.

6.2.17.3 Observed danger

The towing watch must be aware of and report any signs of danger. They include:

- yawing: disabled boat veers from one side to the other, which may cause one or both boats to capsize;
- list increasing on towed boat;
- in step: the proper distance between the towed boat and the towing boat to maintain control and prevent breaking the towline;
- towed boat taking on water;
- deck hardware failure due to stress, no backing plates, etc.;
- towline about to give way due to stress, chafing, or other damage;
- towed boat overtaking your boat due to sudden reduction in speed;
- positioning of towed boat's crew.

6.2.17.4 Maintaining watch

Maintain a tow watch until the disabled boat is moored or until relieved. When relieved, make sure that all important information is passed on to the relief (e.g., problems with chafing gear, towed boat yaws, etc.).

6.2.18 Anchor watch

When the boat is anchored, an anchor watch is set. The person on watch must ensure that the anchor line does not chafe and that the anchor does not drag. The individual on watch also looks for other vessels in the area. Even when the boat is anchored, there is the possibility that it can be hit by another boat.

6.2.18.1 Guidelines

Use the following guidelines when standing anchor watch:

- Check the strain on the anchor line frequently;
- Check to ensure that the anchor line is not chafing;
- Confirm the position of the boat at least every 15 minutes, or at shorter intervals as directed by the coxswain;
- Report bearing or range (distance) changes to the coxswain immediately;
- Report approaching vessels to the coxswain immediately;
- Report major changes in wind velocity or direction;
- Check for current or tidal changes;
- Report any unusual conditions.

6.2.18.2 Check for chafing

Once the anchor is set, apply chafing gear to the anchor line. It is the job of the anchor watch to ensure that chafing gear stays in place and the anchor line does not chafe through.

6.2.18.3 Check for dragging

There are two methods for determining whether your anchor is dragging:

- check for tension on the anchor line;
- check the boat's position.

If the anchor is dragging over the bottom, you can sometimes feel vibration in the line. Periodically check your position by taking a navigational fix. Always use both methods.

6.2.18.4 Check your position

It is important to routinely check your position to ensure that you are not drifting or dragging anchor:

- Take compass bearings to three separate objects spread at least 45° apart. Any bearing changes may indicate that you are beginning to drift;
- On a boat equipped with radar, determine the distance (range) to three points of land on your radar screen. Any change in the ranges may indicate anchor drag;
- On a Loran or GPS equipped boat, mark your position with your equipment. Periodically check your LAT/LONG readout. Any change would show that your position is changing;
- Make a note of each time you check your bearings or ranges. Also note your position and the depth of water regularly. A small note pad is acceptable for this purpose. If the water depth or position changes, the anchor may be dragging.

As the wind or water current change direction, your boat will swing about its anchor. This is a swing circle centred around the position of the anchor, with a radius equal to the boat's length plus the horizontal component of the length of anchor line in use; simply stated, horizontal component + boat length = radius of swing circle at its greatest length. (The horizontal component decreases as the water depth increases.) Ensure your swing circle is clear of other vessels and underwater obstructions. When checking your position, be sure that it falls inside the swing circle.

6.3 AIDS TO NAVIGATION

6.3.1 General

It is essential that you know how to use the various aids to navigation. Here is a list of common aids to navigation and how to use them. The following paragraphs are a summary of the information available in a brochure called “The New Canadian Buoyage System”. If you need more details, you should refer to this brochure.

6.3.2 Buoys

The Canadian buoy system involves extensive use of many kinds of buoys. Everyone involved in marine SAR must know the meaning of every important buoy.

The Canadian Aids to Navigation system is a combined Lateral-Cardinal system. It is important for vessel operators to know the characteristics of each of these systems to ensure safe navigation on our waterways.

Lateral Aids to Navigation

Lateral aids may be either buoys or fixed aids. They indicate the location of hazards, and of the safest or deepest water, by indicating the side on which they are to be passed.

The general rule is: Red, Right, Returning.

Keep the starboard hand (red-coloured) markers/buoys/lights to the starboard side when your vessel is:

- returning from the sea;
- heading in an upstream;
- entering a harbour; or
- proceeding clockwise around the North American continent.

Keep the red markers on your port side when your vessel is:

- proceeding out to sea;
- heading in an downstream direction;
- leaving a harbour; or
- proceeding North along the East Coast of North American.

6.3.2.1 Lateral buoys

Lateral buoys indicate the path to the safest, deepest channel. These buoys can be green (port buoy), red (starboard buoy), red and green (bifurcation buoy) or red and white (fairway buoy). To use lateral buoys, first find the upstream direction. When a boat is going upstream, it is proceeding from the sea toward upstream waters, toward a port (or marina) or in the direction of a rising tide. When you are proceeding in the upstream direction, you should keep the:

- port buoy (green) on your port side;
- starboard buoy (red) on your starboard side.

Bifurcation buoys indicate that one channel is dividing into two different channels, usually a main and a secondary channel. You may navigate safely on either side of a bifurcation buoy, but the main channel is always indicated by the topmost band. If the topmost band

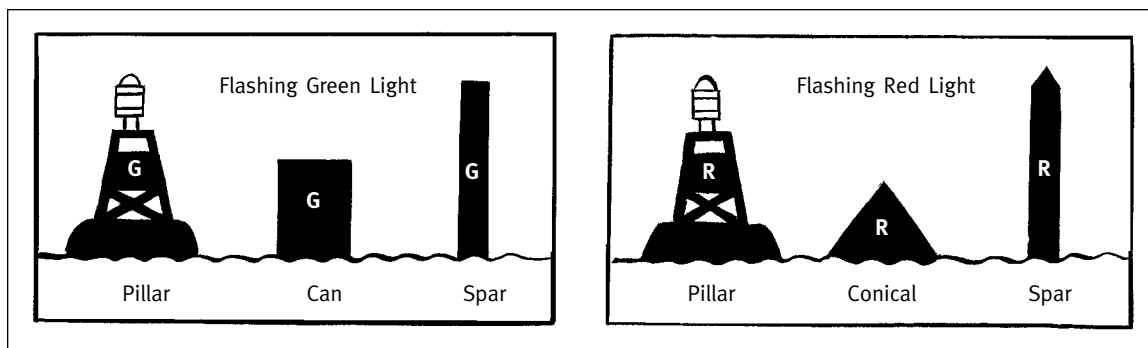

Figure 6.4: All lateral buoys (*G* = green, *R* = red)

is red, keep the bifurcation buoy on your starboard side if you wish to use the main channel (i.e. the bifurcation buoy is considered a starboard buoy).

Fairway buoys indicate the beginning or the middle of a channel. You can go on either side of these buoys. However, since it is good practice to remain on the sides of a channel, you should keep this buoy on your port side when you are going upward.

There is a little mnemonic that can be used to remember which way to keep red end green buoys. This mnemonic is RRR for Red Right Returning. In other words, red buoys should stay on your right (starboard) side when you are returning to a port or going upward.

6.3.2.2 Cardinal buoys

Cardinal buoys indicate the location of the safest and deepest water by reference to the cardinal points of the compass. There are four cardinal buoys: North, East, South and West. Since the cardinal buoys refer to the cardinal points of the compass, it is useful to have a compass in good condition to work with them. All cardinal buoys are yellow and black, and may have white lights and topmarks.

A North cardinal buoy indicates that safe water can be found to the north of it. Its topmost colour is black and its lowermost colour is yellow. Topmarks consist of two black cones pointing upward. If it has a light, it is either a quick flashing light or a very quick flashing light. Refer to your nautical chart for further details.

An East cardinal buoy indicates safe water to the east. Its topmost colour is black, its middle colour is yellow and its lowermost colour is black. Topmarks consist of two black cones base to base. If it has a light, it will usually quickly flash 3 times.

A South cardinal buoy indicates that safe water exists to the south of it. Its topmost colour is yellow and its lowermost colour is black. Topmarks consist of two black cones pointing downward. If it has a light, that light will usually flash quickly 6 times.

A West cardinal buoy indicates safe water exists to the west. Its topmost colour is yellow, its middle colour is black and its lowermost colour is yellow. Topmarks consist of two black

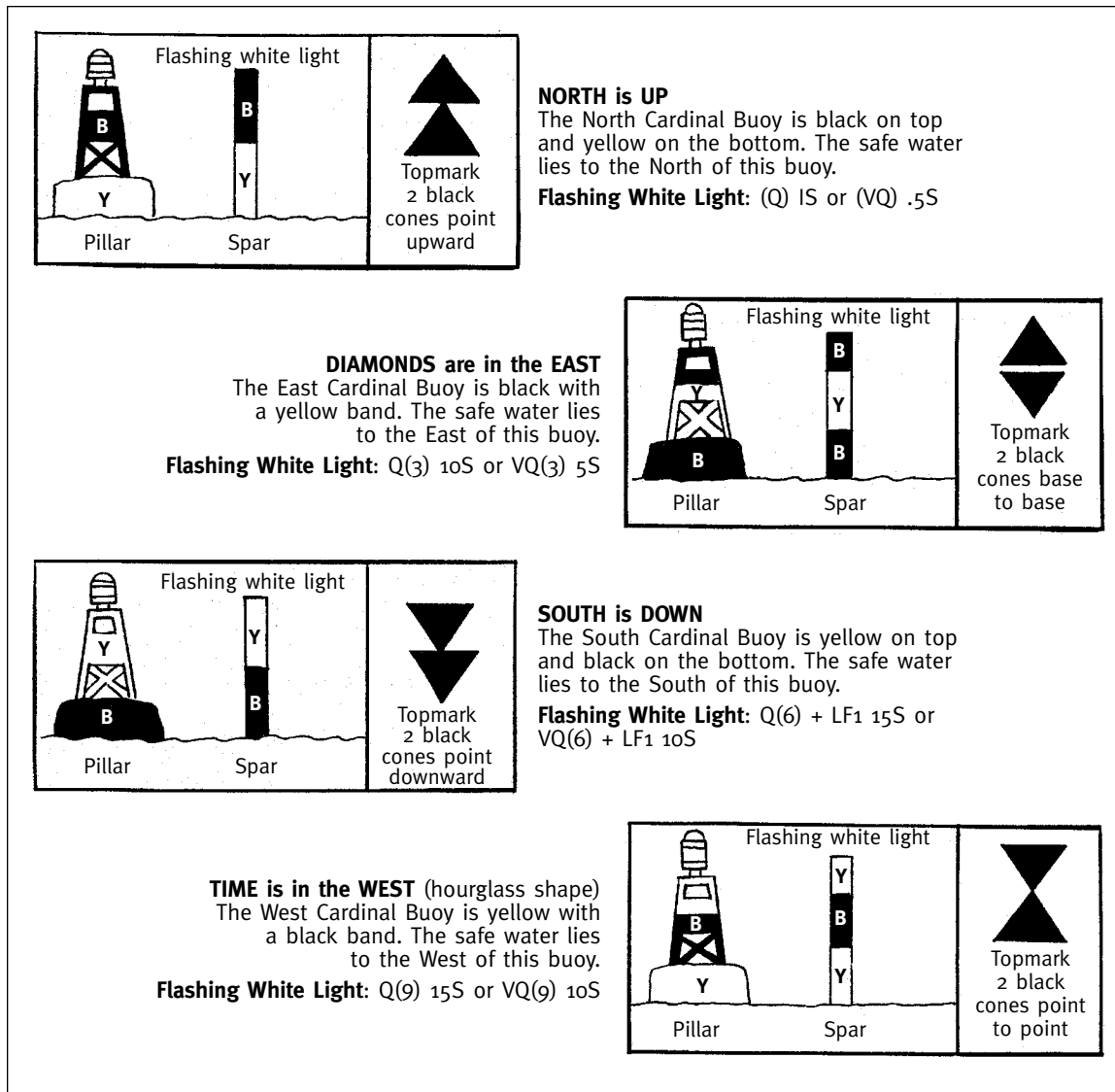

Figure 6.5: The four cardinal buoys (B = black, Y = yellow)

cones point to point. If it has a light, that light will usually flash quickly 9 times. Be aware that to the untrained eye, this may look like an SOS signal (... — ...).

If you take a closer look, you will see that topmarks are pointing toward the black portion of the cardinal buoy.

At night, it is easy to determine the kind of cardinal buoy since the number of flash refers to a direction in the clock system. Three flashes means 3 o'clock (east if we consider 12 o'clock to be north); Six flashes means 6 o'clock (south) and nine flashes means 9 o'clock (west). The only exception is the north cardinal buoy.

6.3.2.3 Special purpose buoys

These buoys can indicate many things. Some may mark the perimeter of designated anchorage areas, while others may mark dangers. Here are some examples:

Anchorage buoys mark a designated anchorage area. These buoys are yellow and usually have a black anchor painted on them. If they possess a light, that light will be yellow.

Cautionary buoys mark dangers such as firing ranges, underwater pipelines, race courses, seaplane bases and areas where no through channel exists. Such buoys are yellow. If a light is present, that light will be yellow as well.

Mooring buoys are used for mooring or securing vessels. These buoys are white with a yellow stripe at their top. If a light is present, that light will be yellow. Be aware that boats or seaplanes may be moored to such buoys.

Keep out buoys are used to mark areas in which boats are prohibited. These buoys are white with an orange cross within an orange diamond. Orange stripes are also present below and above the diamond. If that buoy has a light, this light will be yellow.

Control buoys usually indicate some kind of restriction (speed limit, wash restriction, etc.). These buoys are white with an orange circle. Orange stripes are also present below









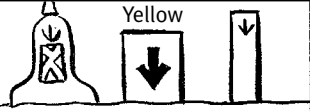

Anchorage	 Yellow	 Yellow	 Yellow
Cautionary	 Yellow	 Yellow	 Yellow
Mooring	 Orange & White	None	 Yellow
Keep out	 Orange & White	None	 Yellow
Control	 Orange & White	None	 Yellow
Information	 Orange & White	None	 Yellow
Swimming	 White	None	 Yellow

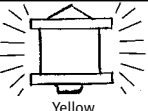
Figure 6.6:
Special buoys

and above the circle. Within the circle, you will find the nature of the restriction. These buoys, if illuminated, will also have a yellow light.

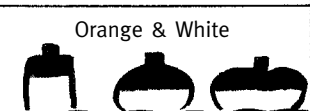
Information buoys are used to display specific information (locality name, marina, campsite, etc.) about an area. These buoys are white with an orange square. Like the two previous buoys, they have orange stripes above and below the square. The information is written inside the square. If a light is present, that light will be yellow.

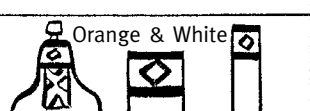
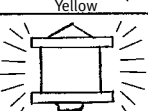
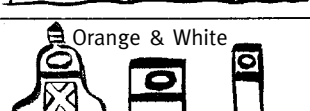
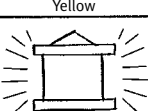
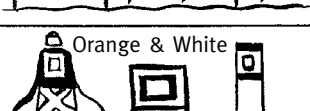
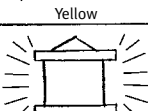
Swimming buoys are used to mark the perimeter of swimming areas. Such buoys are white and may have a yellow light.

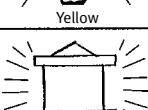
Diving buoys mark a zone where underwater activities are performed. Such buoys are white and possess a diver down flag (red with a white diagonal stripe). These buoys may be attached to the diver or secured to the bottom near the divers. All boats should stay well clear of such buoys to avoid risk of injury to the divers. If you need to approach, proceed at slow speed with extreme caution.

6.3.3 Lights, leading lights, sector lights and direction lights

When you have to navigate by night, lights can be very helpful to guide you. If you know how to use these aids to navigation properly, you will probably be able to travel at greater speed without compromising safety.

6.3.3.1 Lights

Sometimes, lights are set up on shore to mark the entrance of a port or any other important area. On a chart, characteristics of such lights are given. Once you learn to recognize the various lights present on your territory, you might be able to orient yourself a little more easily.

6.3.3.2 Leading lights (also known as range lights)

Leading lights usually consist of two lights separated by some distance. One light is low above the ground while the other is higher. To follow the course indicated by these lamps, you must try to align the two lights so that they appear to be one above the other.

6.3.3.3 Sector lights

Sector lights will be visible only when you are within a certain area (or sector). Some sector lights will have more than one colour. You might see a white light when you are perpendicular to the light (on the desired course) and coloured lights (red or green) if you are looking at the light from an angle (on the sides of the desired course). Other sector lights will show only one colour. Sector lights will become invisible once you reach the limits of their arc of visibility.

6.3.3.4 Direction lights

These are quite similar to sector lights, but they have a much narrower arc of visibility. Usually, when you see such a light, you are steering a specific course (indicated on the map). If you do not stay on course, the direction light will eventually disappear.

CHAPTER 7 – NAVIGATION

7.1	Navigating with charts	7-3
7.I.1	The magnetic compass	7-3
7.I.2	Deviation	7-3
7.I.2.1	Finding deviation	7-3
7.I.3	Anatomy of a chart	7-5
7.I.3.1	Scale	7-5
7.I.3.2	Projection	7-6
7.I.3.3	Datum	7-6
7.I.3.4	Compass Rose	7-6
7.I.3.5	Variation	7-6
7.I.3.6	Latitude and Longitude	7-7
7.I.4	Working with charts	7-7
7.I.4.1	Tools	7-7
7.I.4.2	Measuring distance	7-8
7.I.4.3	Plotting bearings and courses	7-8
7.I.4.4	Correcting for deviation and variation	7-9
7.I.4.5	Uncorrecting for deviation and variation	7-9
7.I.4.6	Distance, speed and time	7-10
7.I.4.7	Danger bearings and angles	7-11
7.I.4.8	Relative bearings	7-14
7.I.4.9	Determining position	7-14
7.I.4.10	The fix	7-15
7.I.4.11	Bearings with the steering compass	7-15
7.I.4.12	Observations on a single object	7-15
7.I.4.13	Dead Reckoning	7-16
7.I.5	Regulations and other printed sources of maritime info	7-17
7.I.5.1	General regulations	7-17
7.I.6	Navigating with charts in a small SAR unit	7-18
7.I.6.1	Know your chart	7-18
7.I.6.2	Visualize	7-18
7.I.6.3	Always know where you are and where you will be	7-19
7.I.6.4	Find good routes to navigate through your territory	7-19

7.2	Electronic navigation	7-19
7.2.1	Radar	7-19
7.2.1.1	General	7-19
7.2.1.2	Basic principle	7-19
7.2.1.3	Advantages	7-20
7.2.1.4	Disadvantages	7-20
7.2.1.5	Minimum range	7-20
7.2.1.6	Maximum range	7-20
7.2.1.7	Operational range	7-20
7.2.1.8	Reading the radar indicator	7-20
7.2.1.9	Operating controls	7-20
7.2.1.10	Reading and interpolating radar images	7-21
7.2.1.11	Radar contacts	7-22
7.2.1.12	Radar fixes	7-22
7.2.2	Loran	7-24
7.2.2.1	General	7-24
7.2.2.2	Receiver characteristics	7-24
7.2.2.3	Determining position	7-24
7.2.2.4	Refining a Loran-C line of position	7-25
7.2.3	Global Positioning System (GPS)	7-26
7.2.3.1	Standard positioning service	7-26
7.2.3.2	Equipment features	7-26
7.2.3.3	Differential Global Positioning System (DGPS)	7-27

7 NAVIGATION

7.1 NAVIGATING WITH CHARTS

Charts are the boater's equivalent of a road map. They provide much more information and are more vital to a boater's safety than a road map is to a motorist. We will first start our discussion on charts by reviewing what can be learned from a general boating course. Next, we will describe how charts should be used on a small SAR unit.

7.1.1 The magnetic compass

The magnetic compass is used to conduct a boat's direction. Since a compass is very useful when it comes to navigating with charts, it is normal that we begin with this topic. The boater should know its principles of operation and always remember that it seeks **Magnetic North**, not **True North**.

A magnetic compass has **primary magnets** that are located on the underside of the **compass card**. These serve to assist the compass in seeking Magnetic North. **Secondary magnets** are located in the base of the **binnacle**. These can be adjusted and serve to reduce error between **magnetic heading** and **compass heading**. Fluid is used in the compass bowl to dampen vibration and oscillation of the card and **expansion bellows** are located in the lower section of the fluid container to allow for changes in the volume of fluid due to expansion and contraction as the temperature changes.

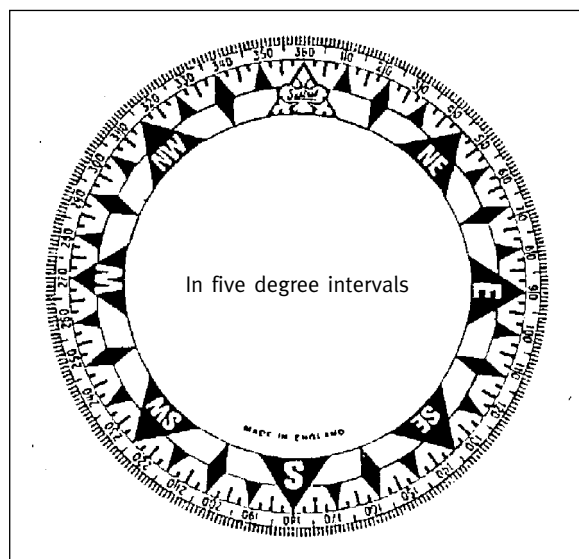

Figure 7.1: The compass card

7.1.2 Deviation

Ferrous materials or electronic gear aboard a boat can set up magnetic fields that will affect the magnetic compass. The effect is to deflect the compass from magnetic north. The error so produced is known as deviation and is the angle, in degrees, between **Magnetic North** and **Compass North**. The error is always either east or west and will change with the boat's heading.

7.1.2.1 Finding deviation

There are a number of ways to find deviation. One of the simplest is to use a fixed navigational range and a **pelorus**. First, determine the magnetic direction of the range. Then run across this range with the boat on compass headings 15° apart. Each time the range is crossed note the compass bearing of the range by sighting with the pelorus. The difference, in degrees, between the compass bearing of the range as observed by the pelorus and the magnetic bearing of the range from the chart is the deviation for that compass heading of the boat. Remember that deviation will vary with the heading of the boat.

Example:

First, locate a set of ranges on a chart of the local area. Obtain the true bearing of the range. sometimes this is printed right on the range line on the chart. If not, align a set of parallel rules on the range line and “walk” the rules to the compass rose. From the outer ring of the compass rose read the TRUE bearing of the range. In Figure 7.2, this direction is 045° T. Note that the variation for the area is 5° W.

By **uncorrecting** we find the magnetic bearing of the range to be 050° M. Next, we align the boat's compass heading to 000° C and proceed to cross the range. We set the pelorus card to correspond to the boat's compass heading. As the boat crosses the range sight across the sighting vanes of the pelorus and note the bearing of the range. This reading will be the compass bearing of the range. In this case we get 048° C.

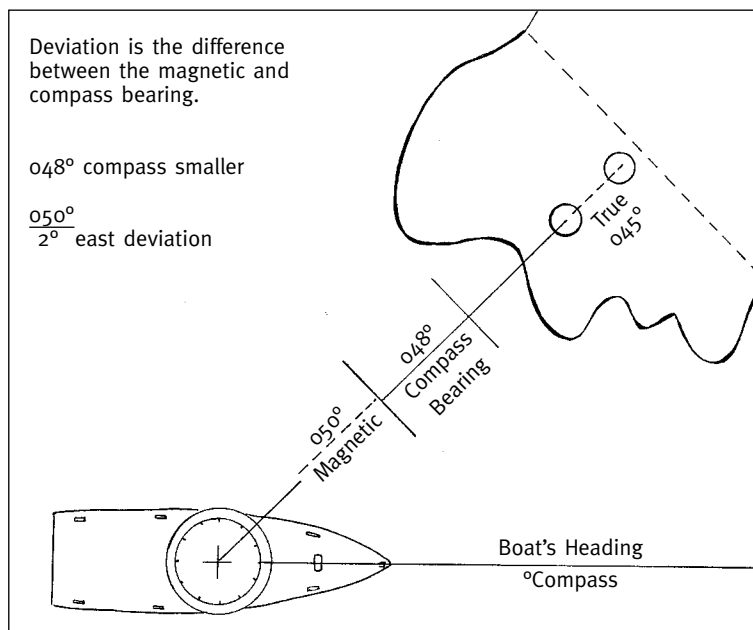

Figure 7.2: Obtaining deviation using ranges

By comparing the magnetic bearing of the range with the compass bearing just obtained we have a discrepancy of 2° , ($050^{\circ}-048^{\circ}$). If the compass bearing is less than the magnetic bearing, the error is **easterly**. If the compass bearing is more than the magnetic bearing, the error is **westerly** (Compass Best Error West, Compass East Error East). In this example, since the compass bearing is less than the magnetic bearing, the error is **easterly**. That is Compass North is 2° East of Magnetic North. We can now say that the compass **deviation** on a boat's heading of 000° is 2° E.

It is advisable to set up a form for recording results when making several runs across a range. The following partial form is an example:

Table 7.1: Deviation table

Compass heading	Magnetic bearing of range	Compass bearing of range (pelorus)	Deviation
000°	050°	048°	2° E
015°	050°	046°	4° E
030°	050°	045°	5° E
045°	050°	047°	3° E

7.1.3 Anatomy of a chart

Much information is given in the **Title Block** and elsewhere around the border of a chart. The **Title Block** will name the country, the province and the area covered by the chart. You will also be able to find out if a chart is metric or not by looking at the Title Block.

The **edition number** and **date** appear in the margin of the chart in the lower left-hand corner. Immediately following these figures will be the **date of the latest revised printing**.

A nautical chart can convey much or little to its user, depending the user's ability to read the chart. A great amount of information must be shown on a chart for safe navigation. In many areas there is little room on the chart to get it all in. Thus, extensive use is made of symbols and abbreviations.

Elsewhere on the chart wherever space is available information will be found such as the meanings of special abbreviations used only on that chart; special notes of **caution** regarding dangers; references to anchorage areas; and other useful bits of information. **All notes on a chart should be read until well understood** as they may cover important information that cannot be illustrated graphically.

To make chart reading easier, quicker and more accurate, the various Canadian agencies that produce nautical charts have adopted a standardized system of abbreviations and symbols. It is essential that boat coxswains and crewmembers have the ability to read and understand their charts rapidly and accurately. Knowledge of the symbols and abbreviations is a must in order to develop this ability. The meaning of all these symbols is given in the Chart No. 1 (a document published by the Canadian Hydrographic Service that can be found where charts are sold).

7.1.3.1 Scale

The scale of charts is commonly stated as a ratio, e.g., 1:100,000 or 1:25,000. A scale stated as 1:100,000 means that one unit of length on the chart represents 100,000 units of length on the surface of the earth. Ratios can be thought of as fractions. That is 1:100,000 can be thought of a 1 over 100,000 or one hundred thousandth. It is easy to see then that 1:100,000 is a smaller scale than 1:25,000.

The smaller the scale of the chart the greater the geographic area that can be shown on a given size chart paper. It is common to use a small scale for charts of large areas showing only major features with little detail. As the scale becomes larger the area covered on the same sheet must decrease but the detail shown can increase. Therefore, charts where much detail is desired such as charts of harbor approaches and facilities will commonly be to scales such as 1:25,000 or 1:12,000 or larger.

For example, the chart of the entire L. Ontario, Chart L2000, is to a scale of 1:400,000 (small scale). Chart 2062, "Oshawa to Toronto" is to a scale of 1:72,000 (a relatively larger scale) while the chart "Toronto Harbor and Approaches," chart 2065, is to a scale of 1:12,000 (an even larger scale). The important thing to observe here is that as the scale gets larger the amount of detail shown on the chart increases.

7.1.3.2 Projection

A chart is a pictorial representation of a portion of the surface of the earth. As the earth is a sphere, some distortion occurs when the curved surface is applied to the flat surface of a chart. Various methods of projecting the curved surface on to the flat have been developed in order to minimize distortion of scale. Canadian pleasure boaters will mostly encounter charts produced on the **Mercator Projection**. Canadian policy now requires that nautical charts be produced using the Mercator Projection in the Metric System.

7.1.3.3 Datum

Datum is a reference level from which depths and heights shown on a chart are measured. In coastal waters where there are tides, two datum references will be given. As an example, chart T3450, which covers the Strait of Georgia (between Vancouver Island and the mainland of British Columbia) shows datum for soundings reduced to lowest normal tides and datum for heights based on higher high water, large tides.

On inland waters, where there is no tide, one datum level is used for both soundings and heights. On Lake Ontario charts the Title Block states that datum is when the gauging station at Kingston, Ontario, reads 74.0 m (242.8 ft.).

The Title Block shows whether depths are measured in fathoms, feet or metres and heights in feet or metres. A scale bar at the bottom of the chart is provided to facilitate conversion of the different units.

7.1.3.4 Compass rose

Every chart has at least one compass rose over printed on it. The **outer ring** of the rose shows **true direction**. The **inner ring** of the rose shows **magnetic direction**. The angle, in degrees, between the True North and the Magnetic North is known as **variation** and is noted on the rose with its annual rate of change.

7.1.3.5 Variation

Variation is the error in compass reading due to the geographic and magnetic poles not being in the same place. This error is the angle between True North and Magnetic North as shown on the compass rose on the chart. Variation is dependent upon geographic location and is stated as being either east or west. Since the magnetic pole is constantly shifting, variation in any locality will change over time. The rate of change is shown on the compass rose and variation should be corrected for the current year before being applied to any navigational plot. Variation is independent of the boat's heading.

7.1.3.6 Latitude and longitude

On a chart, locations are usually determined through the use of a grid system using latitude and longitude. Latitude is measured along the right and left (corresponding to east and west) margins of the chart. Longitude is measured along the top and bottom (corresponding to north and south) margins of the chart.

The scale used may appear in degrees (°), minutes (′), and seconds (″); written as 43° 36′ 18″ (43 degrees, 36 minutes and 18 seconds), OR in degrees and decimal minutes written as 43° 36.3′ (43 degrees, 36 decimal 3 minutes).

Latitude is measured from 00 at the equator to 90° at either the North or South Pole. Therefore, latitude is referred to as being North or South to indicate in which hemisphere the navigator is working. Longitude is measured from 00 at Greenwich, England, East and West to 180°.

Conversion of Seconds to Decimal Minutes is done by dividing the number of seconds by 60. For instance 36″ becomes $(36 \div 60) 0.6′$. Another example 44″ would become $(44 \div 60) 0.7′$. Note that we are rounding off to the nearest 1/10 or 0.1 in our computations. Conversely, to change decimal minutes to seconds, one would multiply the decimal part of the minutes by 60. Certain small discrepancies creep into our work doing these conversions but these are of little consequence in piloting a small craft.

7.1.4 Working with charts

You will find, in the following paragraphs, detailed explanations on how to work with charts, plot position, plan routes, use bearings and compass.

7.1.4.1 Tools

Several tools are needed to work properly with charts. The most commonly used tools are depicted here.

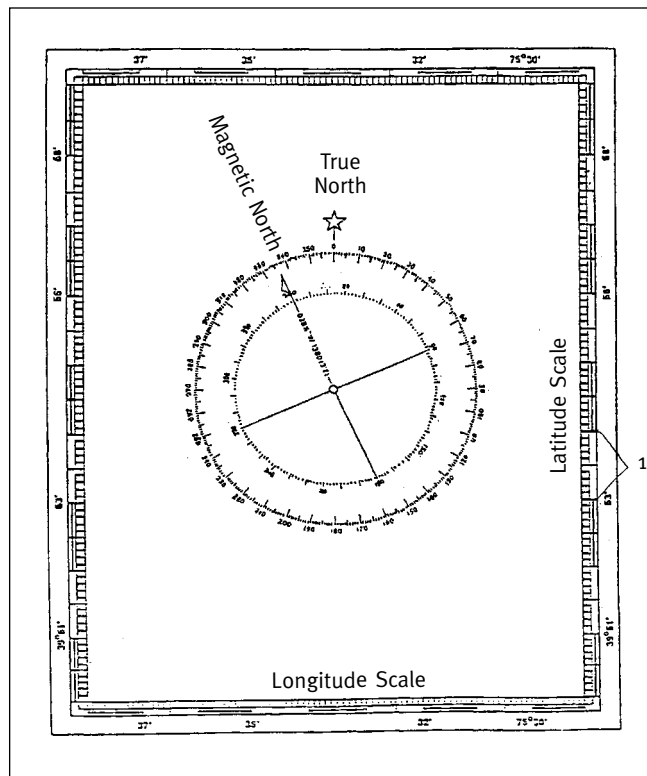
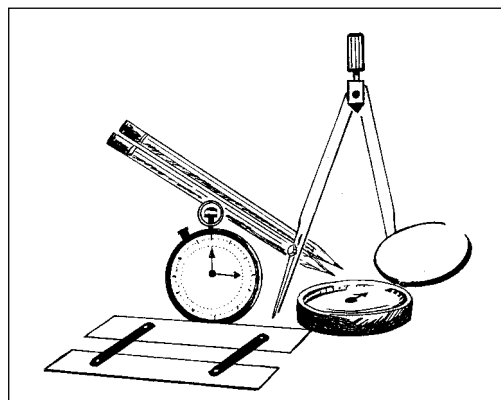

Figure 7.3: Anatomy of a chart

Figure 7.4: Common tools used to work with charts



7.1.4.2 Measuring Distance

Distance is **always** measured on the **latitude scale** (side margins). Due to distortion of scale in producing the chart projection, scale is true and reliable within a narrow band of latitudes. Therefore, when scaling distances on a chart always use the latitude scale immediately to the east or west of the area in which you are plotting.

One minute of latitude equals one nautical mile. Use dividers as illustrated to measure distances. Long distances are stepped off. For instance, 27 miles could be stepped off in 5 steps of 5 miles plus 1 step of 2 miles.

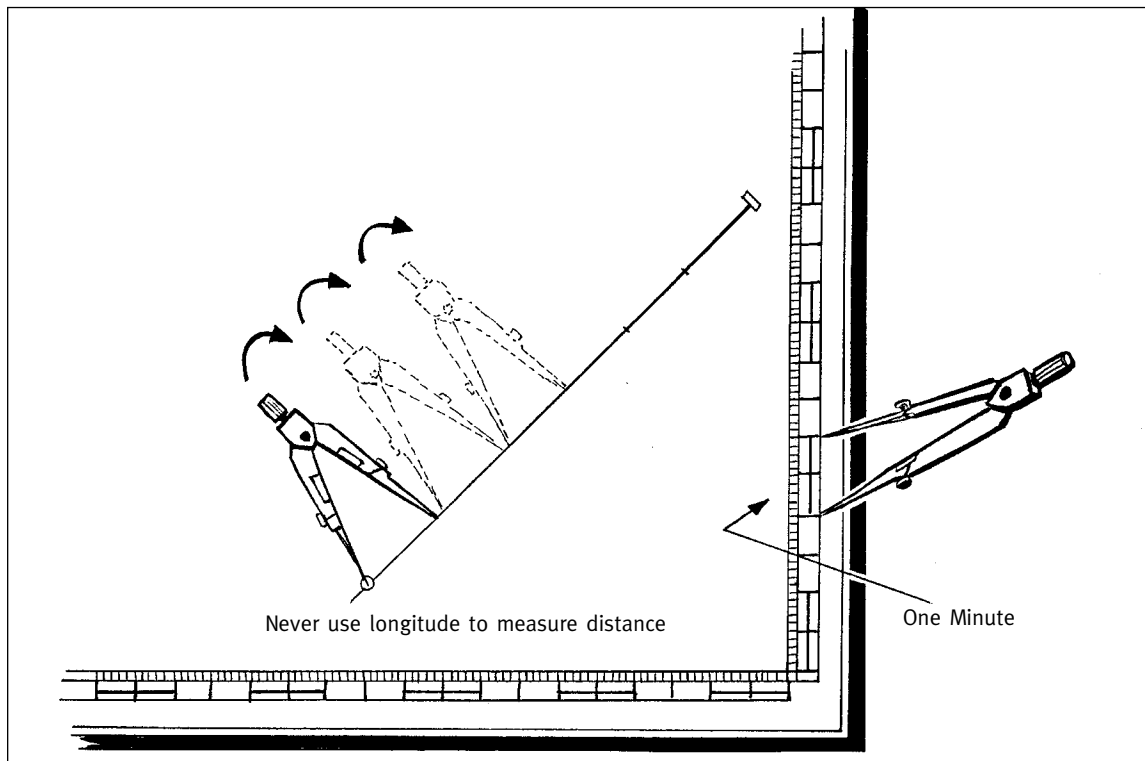

Figure 7.5: Measuring distance on the latitude scale

7.1.4.3 Plotting bearings and courses

Bearings and courses are plotted as **true** on the chart. Therefore, the outer circle of the compass rose is used.

To lay off a course line, set the parallel rule on the compass rose so that one edge of the rule is aligned through the centre of the rose and the desired course on the outer circle. Then “walk” the parallel rule to the part of the chart where you want to draw the course line.

To determine a bearing, say between two objects, set the parallel rule so that one edge passes through both objects. Then, “walk” the parallel rule to the compass rose so that one edge of the rule passes through the centre of the rose. Read the bearing from the outer circle. When reading a bearing from the compass rose, be careful to know the sense of the bearing. That is, is the bearing from A to B or from B to A?

7.1.4.4 Correcting for deviation and variation

We steer the boat by compass and we plot on the chart with true bearings. We must be able to move from one type of bearing to the other rapidly and accurately.

The steps involved in going from a compass reading to a true reading are:

COMPASS DEVIATION MAGNETIC VARIATION TRUE

An old memory aid often used to help recall the order is:

CAN DEAD MEN VOTE TWICE

When correcting a compass course to true, easterly errors are added while westerly errors are subtracted.

For example, let's convert a compass course of 165° to a true course:

C	D	M	V	T
165°	3° W	162°	8° E	170°

First, we must subtract the Westerly deviation from the Compass heading to get the Magnetic heading and then add the Easterly variation to get the True heading.

7.1.4.5 Uncorrecting for deviation and variation

When we plot a course on the chart, we have to convert that course to a compass reading by which to steer the boat. **Uncorrecting** is the process of converting True bearings to Magnetic or Compass bearings. This routine is the opposite of the correcting routine. The elements are listed as:

TRUE VARIATION MAGNETIC DEVIATION COMPASS

For example, let's convert a True course of 215° to a compass course.

T	V	M	D	C
215°	10° W	225°	10° E	215°

We must first add the Westerly variation to the True heading to get the Magnetic heading and then subtract the Easterly deviation to get the Compass heading.

7.1.4.6 Distance, speed and time

The formula used to solve for distance, speed or time when any two of the variables are known is: $60 D = S T$ where:

D = the distance in nautical miles,

S = the speed in knots

T = the time in minutes

60 is a multiplier to allow us to use minutes rather than decimal hours.

When you do these calculations, the distance should be expressed to the nearest 0.1 nautical mile; the time should be determined to the nearest minute and the speed should be expressed to the nearest 0.1 knot.

For example, a boat is running at speed of 14 knots. How far will it travel in 40 minutes?

Solution:

$$60 D = S T$$

$$60 \times D = 14 \times 40$$

$$D = (14 \times 40) \div 60$$

$$D = 9.3 \text{ nautical miles}$$

If it takes a boat 34 minutes to travel 12 miles what is its speed?

Solution:

$$60 D = S T$$

$$60 \times 12 = S \times 34$$

$$S = (60 \times 12) \div 34$$

$$S = 21.2 \text{ knots}$$

If it is 9.5 miles to base and the boat will cruise at 11 knots, how long will it take to run to the base?

Solution:

$$60 D = S T$$

$$60 \times 9.5 = 11 \times T$$

$$T = (60 \times 9.5) \div 11$$

$$T = 52 \text{ minutes}$$

The last example can be used to calculate an E.T.A. The problem is that it involves some mental calculations and it may not be so helpful in stressful situations. Another quick method can be used. All you need is a chart and a pair of navigational dividers. Let's say you are tasked somewhere and the rescue coordination centre wants to know your E.T.A. You know that your top speed is 40 knots. Just divide 40 knots by 10. This will tell you how many nautical miles you can travel in 6 minutes (since one knot is one nautical mile per 60 minutes). It thus gives you 4 nautical miles per 6 min. Measure 4 nautical miles on the latitude scale with the dividers. Then, simply use the dividers to find how many minutes you will need to reach your destination. If you need 4 times the length measured with the dividers, you know that you will need $4 \times 6 = 24$ minutes to reach your destination. As you can see, this method can be really quick and it does not involve extensive mental calculations.

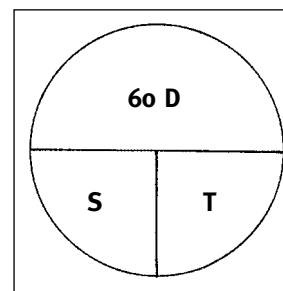

Figure 7.6: The distance/speed/time circle

Yet another easy way to remember how to calculate time speed and distances is to use the “distance/speed/time circle.”

To use that circle, you simply need to cover the value you are looking for. The circle will give you the formulae you need.

7.1.4.7 Danger bearings and angles

Safe passage

There may be times during the course of a voyage that you must maintain a minimum (or maximum) distance offshore, or that you must negotiate a narrow passage in order to avoid a shoal area or underwater hazard that is not marked by an aid to navigation. The solution to a safe passage may lie in the use of danger bearings or danger angles.

To ensure safe passage while underway, the following method may be used: danger bearings, with a compass or pelorus; danger angles (horizontal), with a pelorus or sextant.

Danger bearings

Small vessels operating among islands and shoal waters can often take advantage of the three techniques illustrated here.

Figure 7.7a describes a potentially hazardous situation. You leave Port departure bound for Port destination some 12 miles North-northeast and somewhere up the coast. Along the way you know from your chart that up the Coast of Wreck Inlet lies an unmarked area of foul ground and rocks awash that is not marked by any aid to navigation. You plot a course to go well out to sea before turning onto a true course of 045° . However, wind or current could cause your course made good to take you into foul ground. How do you avoid this situation? Establish a danger bearing.

Figures 7.7(a-f):
Use of danger bearing to avoid a hazard

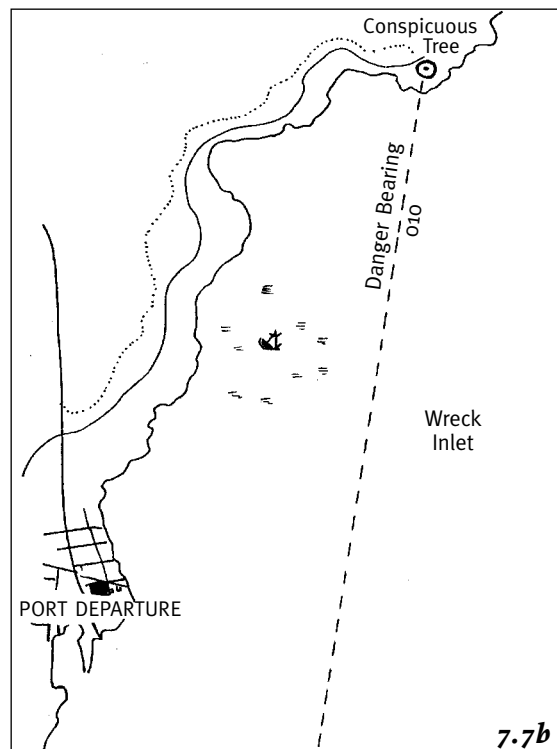
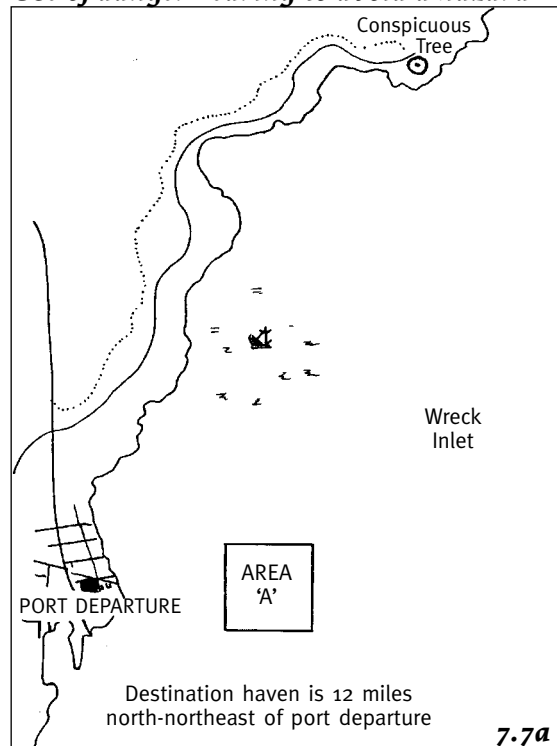

Select some objects along the shoreline well beyond the hazard and which is shown on the chart. In Figure 7.7a we have selected the “conspicuous tree.” Draw a line from that object tangent to (touching) the hazard so that the hazard will lie inshore of the line. Allow a little extra room for safety’s sake. Determine the true direction of this line toward the object. (See Figure 7.7b)

We suggest that you plot and label the line as shown: it is a danger bearing. In this example if, at any time when you are in the vicinity, you take a bearing on this object and your true bearing is less than the danger bearing you will be to seaward of the foul ground and therefore in a safe area. If your true bearing is greater, you are in danger. Keep in mind that as you travel you must convert your compass bearing to compare it with your true danger bearing. You can prove this to your own satisfaction by referring to Figure 7.7c.

You are somewhere in the vicinity of area A and we established a danger bearing of 010° true. If you take a bearing on the object as 000° true, then you must be on that LOP which does not pass through the foul ground. On the other hand, if your bearing at any time is 020° true, you must be on that line: it does pass through the foul ground.

Whether to maintain a bearing greater or lesser than the danger bearing depends on your direction of travel and on which side of you the hazard lies. Determine this by inspection after plotting your danger bearing.

Let us leave Port departure and apply this knowledge to ensure a safe passage. Refer to Figure 7.7d. We propose to follow course 100° true until we have reached a distance offshore that will allow us to safely clear the foul ground after turning onto our intended course of 045° true. We have plotted our danger bearing 010° . The safest way will be to con-

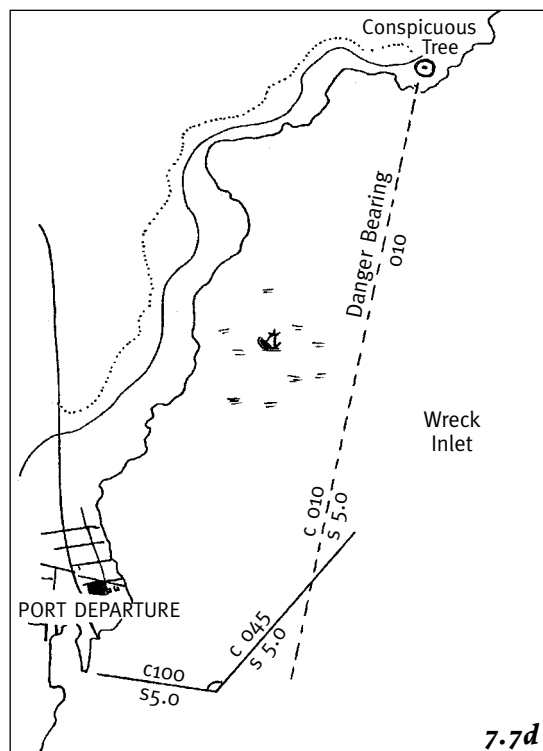
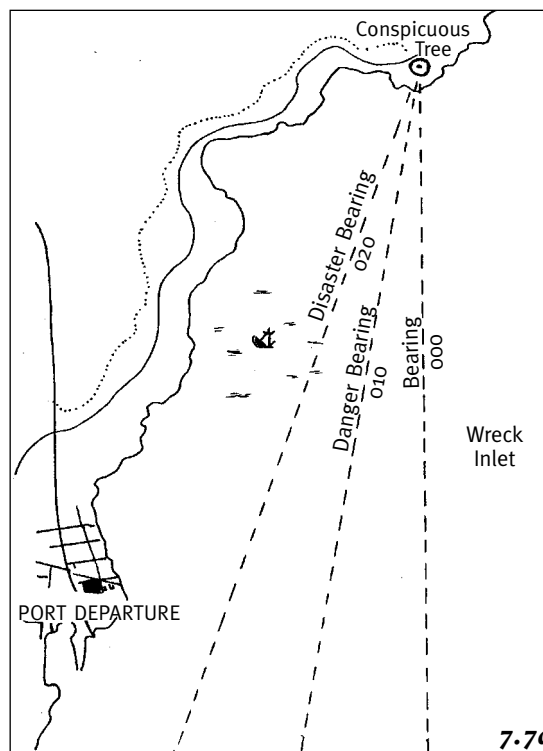

tinue 100° until we have crossed the danger bearing before turning onto course 045° true. However, the proposed method is also satisfactory. After turning onto course 045°, we frequently take a bearing on the “conspicuous tree.” If this true bearing does not become 010° or less by the time that we reach the vicinity of the foul ground, then we had best change course to starboard and sail offshore until we are on the proper side of the danger bearing. We continue to take bearings on the object until we are well beyond the hazardous area.

Danger angles – compass bearings

We have consistently referred to true courses and true bearings. You would have converted these in you log to compass bearings. The compass danger bearing will be calculated using the deviation of the intended compass course (deviation is according to ship’s heading).

Relative bearing danger angles – Pelorus

The relative bearing of the danger bearing while on course 045° may be quickly determined by subtracting the course (true) from the danger bearing (true): Relative bearing = Danger bearing (True) – True Course.

On the example:

$$010^{\circ} - 045^{\circ} = (010^{\circ} + 360^{\circ}) - 045^{\circ} = 370^{\circ} - 045^{\circ} = 325^{\circ} \text{ Relative Danger Bearing.}$$

While on your intended compass course equivalent to true course 045° and with your pelorus set at 325° relative, periodically ensure that your pelorus sighting is on the proper (in this case seaward) side of the object. Otherwise, move further offshore until the proper conditions exist.

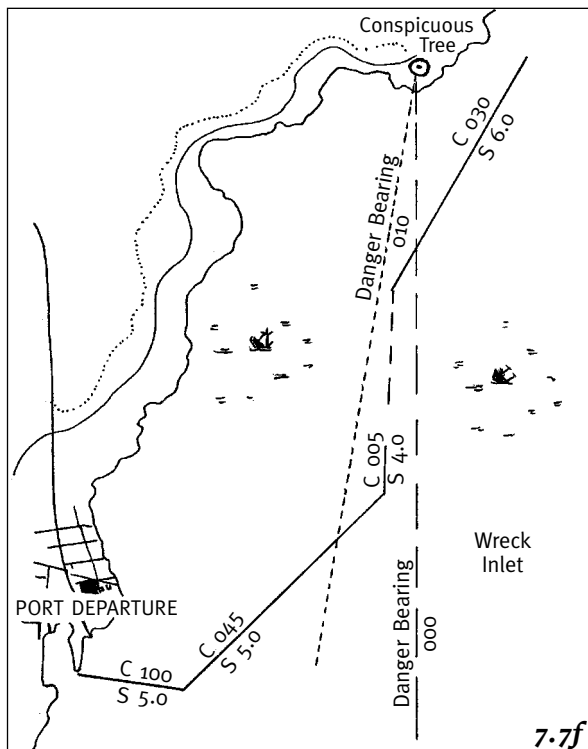
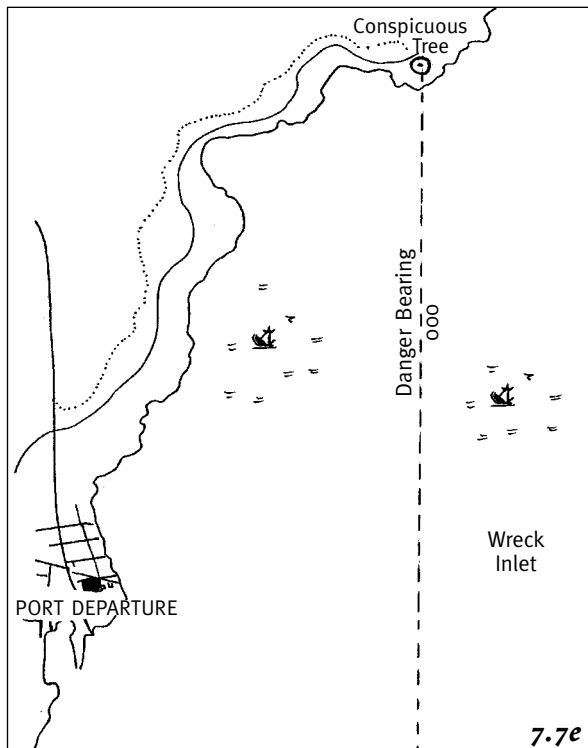

Similarly, a danger bearing may be used to safely pass inshore of an outlying hazard (Figure 7.7e) or to thread a passage between two hazards (Figure 7.7f). There is no need that the object be on the landward side or that it be ahead of you. You can, of course, take the bearing over starboard, quarter or stern.

7.1.4.8 Relative bearings

A **relative bearing** is measured from 000° at the boat's head in a clockwise direction to the target. Radar commonly gives relative bearings to targets. These bearings must be changed to True before being plotted on a chart. To do so, you must know the True heading of your boat.

For example, you are running on a True heading of 047° when a bearing is taken on a distant landmark. The bearing was 062° Relative. To find the True bearing of the target landmark, you just need to add your bearing to the relative bearing. This gives you ($047^\circ + 062^\circ$) 109° .

If the result you get by adding the two bearings is more than 360° , just subtract that 360° . For example, if your boat is running on a True heading of 302° and the bearing to a target is 321° Relative, the true bearing of the target will be ($302^\circ + 321^\circ$) 623° . This result is more than 360° , so, to get a more intuitive result, we will remove the extra 360° . The final bearing is thus ($623^\circ - 360^\circ$) 263° .

7.1.4.9 Determining position

The art of piloting reaches its climax in the determination of position. Underway, on a body of water of any size, where the safety of the boat and its crew is at stake, it is not "where one ought to be," or "where one thinks one is," but the knowledge of, "where one is for certain," that counts. The ability to determine position quickly and accurately under a variety of conditions should be one of the primary goals for a coxswain.

A pelorus may be used to measure horizontal angles, relative bearings and determine compass bearings. Since the instrument is completely unaffected by magnetic influences it may be used from any location aboard from which a line of sight can be made. The caution to be observed when using the pelorus is that the instrument must be accurately aligned with or be parallel to the fore-and-aft axis of the boat whenever it is set up for making an observation.

Lines of Position are the basic elements in determining position. A single Line of Position (LOP) does not provide a **fix** but can be used to obtain an **estimated position** (EP). A LOP is an indicator that the vessel lies somewhere along the plotted line. A bearing on an identifiable object or two objects in transit will provide a straight LOP. Radar ranges provide circular LOPs.

7.1.4.10 The fix

In coastal piloting, a boat's position is called a fix when that position has been determined with the aid of reliable charted information. As previously stated one LOP will indicate a number of possible positions for a boat. Two simultaneous LOPs that intersect indicate a highly probable position or a fix. Three simultaneous LOPs are desirable as the third LOP serves as a verifier.

The ideal situation is where three LOPs intersect at a common point. In actual practice such fine geometry is an accident or seldom happens. In the event that the LOPs do not meet at a common point but form a small triangle ("cocked hat") the fix is taken as the centre of the triangle.

Bearings for LOPs should be such that intersections are never less than 60° nor greater than 120° for best results. Ideally, three bearing lines should cut at 60° with each other. This is not possible in practice but one should try to meet this standard when choosing points to observe for LOPs for the sake of accuracy.

7.1.4.11 Bearings with the steering compass

It is possible to take bearings directly over the steering compass of a small craft in order to obtain a LOP. The craft must be stopped and manoeuvred in one position so that the centreline of the craft is pointing directly at the target when the bearing is read from the steering compass. These bearings must be corrected for deviation and variation before being plotted on the chart.

Two bearings taken in this manner on two identifiable charted features, corrected to True and plotted, will provide a **2 – LOP fix**.

7.1.4.12 Observations on a single object

Position can be determined by taking two successive bearings on the same object as the boat holds a steady course and speed. The first sight is made when the object bears 045° Relative or 315° Relative. That is when the object bears either 45° to port or starboard. This bearing is called a **Bow Bearing**. The second sight is made when the object is broad on the beam at either 90° R or 270° R. This will be the **Beam Bearing**. Once you have your **Bow** and **Beam Bearings**, you can get a **fix**.

The geometry is such that the distance run between sights is equal to the distance off the object at the time of the second sighting. Therefore, from the charted object with the second LOP and the distance off, the boat's position at the time of the second sight may be plotted as a fix.

The bow and beam bearing in the previous method is a special case of the same geometry we will use for the next method. With the bow and beam bearing method, one must wait until the object is abeam before a fix can be made. In general, the same approach can be used by doubling the angle on the bow. Consider using 30° as the first sighting angle; then, 60° as the second sighting angle off the bow. The boat's position will be determined before the sighted object is abeam.

The detailed procedure for Fix by Bow and Beam Bearing (or by Doubling the Angle on the Bow) is as follows:

- Observe the object at the smaller angle off the bow and record the time (ss.mm.hh);
- Maintain course and speed;
- Observe the object at the larger angle off the bow and record the time (ss.mm.hh);
- Determine the time interval of the run between sightings;
- Compute the distance run using $60 D = S T$;
- Convert the Relative bearing obtained in the third step to True and plot the LOP through the object sighted;
- Scale the distance calculated in the fifth step from the object along the LOP to obtain a fix;
- Label the position obtained in the previous step with identification and time (FIX 1325).

7.1.4.13 Dead Reckoning

In **Dead Reckoning** (DR) all plotting begins at a known position. To that position, course lines representing the vessel's run are applied in sequence, considering only **direction**, **time** and **speed**. No allowance is made for current or leeway. A DR plot ends when a known position is reached and at that point, a new DR run begins. When using dead reckoning, you should consider the following:

- Only actual courses steered are used in DR plotting;
- The distance traveled is scaled off the chart or determined from the formula $60 D = S T$;
- An intended DR plot is always begun from a known position;
- The effects of wind or current are not considered in determining a DR position.

A DR plot may be used for planning a cruise or for keeping approximate track of position during a cruise. **Plot lines** are labeled with **course** and **speed**. Points at which courses change are plotted as a dot within a circle and labeled with time and DR.

When doing a DR plot:

- It is important that all lines and points on the DR plot be labeled;
- Label the direction of course (C 235°) along the line and above it;
- Label the speed on a course (S 15) along the line and beneath it;
- Any point along a DR plot should be labeled as small circle with a dot. The time at that point should be penciled in beside the circle with DR, (1032 DR).

A DR plot should be updated:

- at least every hour on open water;
- at the time of every course change;
- at the time of making a fix or a running fix;
- at the time of every change of speed;
- at the time of obtaining a Line of Position.

7.1.5 Regulations and other printed sources of maritime info

7.1.5.1 General regulations

Charts and Nautical Publications Regulations requires all operators of ships and boats to have on board the latest edition of the largest scale chart, documents and publications for each area they are navigating and to keep these documents up-to-date.

Vessels under 100 tons are exempt if the person in charge of navigation has sufficient knowledge of the following information, such that safe and efficient navigation in the area where the ship is to be navigated is not compromise: the location and character of charted shipping routes, lights, buoys and marks; navigational hazards and the prevailing navigational conditions, taking into account such factors as tides, currents, ice and weather patterns.

Canals, Barrages		SNS/SCNS c.d	Canaux, Barrages	
40		Canal with distance mark Canal avec marque de distance		
41.1		Lock (large-scale charts) Écluse (cartes à grande échelle)		
41.2		Lock (smaller scale charts) Écluse (cartes à plus petite échelle)		
42		Caisson Bateau-porte		
43		Flood barrage Barrage de protection		
44		Dam Barrage		

Transshipment facilities		Installations pour le transbordement	
50	RoRo	Roll-on, Roll-off ferry (RoRo) Navire roulier (RoRo)	
51		Warehouse with designation Entrepôts avec désignation	
52		Timber yard Chantier à bois	
53.1		Crane, Travelling crane Grue, Grue mobile	
53.2		Container crane Grue pour conteneurs	
53.3		Sheerlegs (conspicuous) Grue, Bigue (remarquable)	

Figure 7.8: Sample of chart number one

To supplement the information shown on charts, vessel operators can refer to the following publications:

- *Chart No. 1* (now a booklet) *Symbols and Abbreviations*;
- *The New Canadian Buoyage System*;
- *Safe Boating Guide*;
- *Canadian List of Lights, Buoys and Fog Signals*;
- *Sailing Directions*;
- *Chart Information Catalogue*;
- *Boating Direction for Small Vessels*;
- *Radio Aids to Marine Navigation*;
- *Radio Telephone Operator's Handbook*;
- *Notices to Mariners*;
- *Canadian Tide and Current Tables*.

7.1.6 Navigating with charts in a small SAR unit

While you were reading the previous paragraph, it probably occurred to you that most of the techniques presented are time consuming. Also, nautical charts have a tendency to be fairly large. Working with such large charts requires space and protection from the elements. These are two things that many SAR units don't have. Trying to plot a course while already "en route" will usually be a difficult thing to accomplish on most SAR units. Charts, even if the traditional way to work with them does not always apply, can still be very useful to SAR units. Let's now see what is the best way to use nautical charts when you are involved in SAR.

7.1.6.1 Know your chart

Everybody in a SAR team should spend some time to study the charts that cover their territories. You must learn the distinctive features of the area you are covering. Pay attention to the location of special aids to navigation such as cardinal buoy and lighthouses. Learn where are the various channels and how to get to them. Memorize the number of important buoy. Usually, all buoys from the same channel have a similar number (AE32, AE33, AE34, etc.). Buoys in main channel are usually designated by a letter and a number (H33, H35, etc.) while buoys in secondary channels are designated by two letters and a number (HD18, HD19, etc.). Knowing the letter designation of buoys is especially useful when someone gives its position by telling you the number of the closest buoy. It might also be a good idea to get a general idea of the depth at the various areas covered by your charts. Shallow areas that may be hazardous to navigation should be known.

7.1.6.2 Visualize

By simply looking at your chart, you should be able to visualize the area you are looking at. In other words, you should be able to translate symbols and shore contour into real landscape. This is a skill that requires practice. The best way to improve your visualization skill is to spend some time on the water. Explore your territories and always monitor your progress on the chart. Look at lights in daytime and try to imagine how they will look at night. Once you master this skill, you will be able to know exactly where you are on a chart by simply looking around.

7.1.6.3 Always know where you are and where you will be

As a SAR crew, you must always be aware of your position on the chart. This means that you should never have to get a fix to know where you are. Electronics (RADAR, GPS and electronic charts) are quite handy to keep track of your position. However, you should be able to know where you are without using these devices. There is always a risk of malfunction with electronics and that's why you have to know how to find your position manually. In addition, all these electronic devices are telling you where you were a few seconds ago. They can never tell where you are now exactly or where you will be in the next minutes. By calculating your ETA with the simple method presented in the end of section 7.1.4.6, you should always be able to know where you will be in the next six minutes. Remember that to use this method, you may have to do time trials with your boat in order to effectively translate RPM into actual speed.

7.1.6.4 Find good routes to navigate through your territory

Routes should be used but not exactly in the way that was given previously. A good SAR crew will plan a few routes before going on the water. Routes are useful for hazardous areas (shallow water, narrow channels, etc.). When you plan routes, try to use what is called "landmark navigation" which is using the distinctive features of the landscape as reference point (these are easier to remember than compass courses). Take local anomalies (tides, currents, shallow areas, etc.) into consideration when you plan your routes. It may also be a good idea to prepare a sheet of paper on which you have all the courses to steer to get to various places (and the corresponding ETAs). On that sheet, you could also place the name, addresses and coordinates (lat., long.) of all the marinas on your territories. Once you have planned a few routes, you should be able to reach any area of your territory quickly and safely. Do not wait to be called somewhere to plan a safe route to go there.

7.2 ELECTRONIC NAVIGATION**7.2.1 Radar****7.2.1.1 General**

Radar is an aid in navigation. It is not the primary means of navigation. Boat navigation using radar in limited visibility depends on the coxswain's experience with radar operation. It also depends on the coxswain's knowledge of the local operating area and is not a substitute for an alert visual lookout.

7.2.1.2 Basic principle

Radar radiates radio waves from its antenna to create an image that can give direction and distance to an object. Nearby objects (contacts) reflect the radio waves back and appear on the radar indicator as images (echoes). On many marine radars, the indicator is called the plan position indicator (PPI).

7.2.1.3 Advantages

Advantages of radar include:

- use at night and low visibility conditions;
- obtain a fix by distance ranges to two or more charted objects. An estimated position can be obtained from a range and a bearing to a single charted object;
- rapid fixes;
- fixes may be available at greater distances from land than by visual bearings;
- assistance in preventing collisions.

7.2.1.4 Disadvantages

The disadvantages of radar include:

- mechanical and electrical failure;
- minimum and maximum range limitations.

7.2.1.5 Minimum range

The minimum range is primarily established by the radio wave pulse length and recovery time. It depends on several factors such as excessive sea return, moisture in the air, other obstructions and the limiting features of the equipment itself. The minimum range varies but is usually 18 to 45 m from the boat.

7.2.1.6 Maximum range

Maximum range is determined by transmitter power and receiver sensitivity. However, these radio waves are line of sight (travel in a straight line) and do not follow the curvature of the earth. Therefore, anything below the horizon will usually not be detected.

7.2.1.7 Operational range

The useful operational range of a radar on a boat is limited mainly by the height of the antenna above the water.

7.2.1.8 Reading the radar indicator

Interpreting the information presented on the indicator takes training and practice. The radar indicator should be viewed in total darkness, if possible, for accurate viewing of all echoes. Also, charts do not always give information necessary for identification of radar echoes, and distance ranges require distinct features.

It may be difficult to detect smaller objects (e.g., boats and buoys) in conditions such as:

- heavy seas;
- near the shore; or
- if the object is made of nonmetallic materials.

7.2.1.9 Operating controls

Different radar sets have different locations of their controls, but they are basically standardized on what function is to be controlled. The boat crew should become familiar with the operation of the radar by studying its operating manual and through the unit training program.

7.2.1.10 Reading and interpolating radar images

The plan position indicator (PPI) is the face or screen of the CRT (Cathode Ray Tube) which displays a bright straight radial line (tracer sweep) extending outward from the centre of a radar screen. It represents the radar beam rotating with the antenna. It reflects images on the screen as patches of light (echoes).

In viewing any radar indicator, the direction in which the boat's heading flasher is pointing can be described as up the indicator. The reciprocal of it is a direction opposite to the heading flasher, or down the indicator. A contact moving at right angles to the heading flasher anywhere on the indicator would be across the indicator.

The centre of the radar screen represents the position of your boat. The indicator provides relative bearings of a target and presents a map-like representation of the area around the boat. The direction of a target is represented by the direction of its echo from the centre, and the target's range is represented by its distance from the centre.

The cursor is a movable reference and is controlled by the radar cursor control. The cursor is used to obtain the relative bearings of a target on the indicator.

Radar bearings

Radar bearings are measured relative the same as you would in visual bearings with 000° relative being dead ahead. In viewing any radar indicator, the dot in the centre indicates your boat's position. The line from the centre dot to the outer edge of the indicator is called the heading flasher and indicates the direction your boat is heading.

To obtain target relative bearings, adjust cursor control until the cursor line crosses the target. The radar bearing is read from where the cursor line crosses the bearing ring.

Note: Like visual observations, relative bearings measured by radar must be converted to magnetic bearing prior to plotting them on the chart.

Target range

Many radars have a variable range marker. You dial the marker out to the inner edge of the contact on the screen and read the range directly.

Other radars may have distance rings. If the contact is not on a ring, you would estimate (interpolate) the distance by its position between the rings.

Example:

The radar is on the range scale of 2 nautical miles, and has 4 range rings. Range information is desired for a target appearing halfway between the third and fourth rings.

- Range rings on the two mile scale are 1/2 mile apart (4 rings for 2 miles means each ring equals 1/4 of the total range of 2 miles).

7.2.1.11 Radar contacts

Even with considerable training you may not always find it easy to interpret a radar echo properly. Only through frequent use and experience will you be able to become proficient in the interpretation of images on the radar screen.

Knowledge of the radar picture in your area is obtained by using the radar during good visibility and will eliminate most doubts when radar navigating at night and during adverse weather. Images on a radar screen differ from what is seen visually by the naked eye. This is because some contacts reflect radio waves (radar beams) better than others.

Common radar contacts

A list of common radar contacts and reflection quality follows:

Contact	Integrity
Reefs, shoals, and wrecks	May be detected at short to moderate ranges, if breakers are present and are high enough to return echoes. These echoes usually appear as cluttered blips.
Sandy spits, mud flats and sandy beaches	Return the poorest and weakest echoes. The reflection, in most cases, will come from a higher point of land from the true shoreline such as bluffs or cliffs in back of the low beach. False shorelines may appear because of a pier, several boats in the area, or heavy surf over a shoal.
Isolated rocks or islands off shore	Usually return clear and sharp echoes providing excellent position information.
Large buoys	May be detected at medium range with a strong echo; small buoys sometimes give the appearance of surf echoes. Buoys equipped with radar reflectors will appear out of proportion to their actual size.
Piers, bridges and jetties	Provide strong echoes at shorter ranges.
Rain showers, hail and snow	Will also be detected by radar and can warn you of foul weather moving into your area. Bad weather appears on the screen as random streaks known as "clutter."

7.2.1.12 Radar fixes

Radar navigation provides a means for establishing position during periods of low visibility when other methods may not be available. A single prominent object can provide a radar bearing and range for a fix, or a combination of radar bearings and ranges may be used. Whenever possible more than one object should be used. Radar fixes are plotted in the same manner as visual fixes.

Note: If a visual bearing is available, it is more reliable than one obtained by radar.

Example:

On a compass heading of 300° , you observe a radar contact (image) bearing 150° relative. Deviation, from the deviation table, for the boat's compass heading (300° C) is 3° E. Obtain the magnetic bearing of the contact.

Procedure

- Correct your compass heading of 300° to magnetic heading. Write down the correction formula in a vertical line.

$$C = 300^\circ$$

$$D = 3^\circ \text{ E (+E, - W when correcting)}$$

$$M = 303^\circ \text{ M}$$

$$V = \text{not applicable in this problem}$$

$$T = \text{not applicable in this problem}$$

- Compute information you have opposite appropriate letter in previous step. Add the easterly error 3° E deviation to the compass heading (300° C) to obtain the magnetic course of 303° M).
- Add the radar relative bearing (150 degrees relative) to the magnetic heading (303° M) to obtain magnetic bearing of the radar contact (093° M).

$$303^\circ + 150^\circ = 453^\circ \text{ degrees (greater than } 360^\circ)$$

$$453^\circ - 360^\circ = 093^\circ \text{ M bearing of contact}$$

Range rings

Radar range rings show up as circles of light on the screen to assist in rings estimating distance. Major range scales are indicated in miles and are then subdivided into range rings. Typical range scales for a boat radar are $1/2$, 1, 2, 4, 8, and 16 nautical miles (NM). Typical number of range rings for a particular range scale are shown in the table below.

Scale/Miles	Rings	NM Per Ring
$1/2$	1	$1/2$
1	2	$1/2$
2	4	$1/2$
4	4	1
8	4	2
16	4	4

Lines of position

Radar lines of position (LOPs) may be combined to obtain fixes. Typical combinations include two or more bearings; a bearing with distance range measurement to the same or another object; two or more distance ranges. Radar LOPs may also be combined with visual LOPs.

Care should be exercised when using radar bearing information only since radar bearings are not as precise as visual bearings. A fix obtained by any radar bearing or by distance measurement is plotted on the chart with a dot enclosed by a circle to indicate the fix and label with time followed by "RAD FIX," such as, 1015 RAD FIX.

Distance measurements example:

At 0215, you are on a course of 303° (303° M). Your radar range scale is on 16 miles. You observe two radar contacts (land or charted landmark). The first has a bearing of 330° relative at 12 NM. This target is on the third range circle. The second target is bearing 035° relative at 8 NM. This target is on the second range circle. Obtain a distance measurement fix.

Note: Radar ranges are usually measured from prominent land features such as cliffs or rocks. However, landmarks such as lighthouses and towers often show – at distance when low land features do not.

Procedure:

- Locate the objects on the chart;
- Spread the span of your drawing compass to a distance of 12 NM (distance of first target), using the latitude or nautical mile scale on the chart;
- Without changing the span of the drawing compass, place the point on the exact position of the object and strike an arc towards your DR track, plotting the distance;
- Repeat the above steps for the second object (distance of 8 NM). Where the arcs intersect is your fix (position). Label the fix with time and “RAD FIX” (0215 RAD FIX).

A DR plot typically includes many types of LOPs and fixes.

7.2.2 Loran

7.2.2.1 General

Derived from the words LOnG RAnge Navigation, Loran-C is a navigation system network of transmitters consisting of one master station and two or more secondary stations. Loran-C is a pulsed, hyperbolic (uses curved lines) system. Loran-C receiver's measure the Time Difference (TD) between the master transmitter site signal and the secondary transmitter site signal to obtain a single line of position (LOP). A second pair of Loran-C transmitting stations produces a second LOP. Plotting positions using TDs requires charts overprinted with Loran-C curves. However, many modern Loran-C receivers convert Loran-C signals directly into a readout of latitude and longitude, the mariner then can use a standard nautical chart without Loran-C curves. It is accurate to better than .25 nautical mile (NM).

7.2.2.2 Receiver characteristics

Different Loran receivers have different locations of their controls, but they are basically standardized on what function is to be controlled. The boat crew should become familiar with the operation of the Loran receiver by studying its operating manual and through the unit training program.

Note: Loran-C is not accurate enough for precise navigation, such as staying within a channel.

7.2.2.3 Determining position

Many Loran-C receivers give a direct readout of latitude and longitude position which can be plotted on the chart. Depending on the receiver, the conversion of Loran signals to lati-

tude and longitude may lose some accuracy. The readout typically goes to two decimal places (hundredths) but plotting normally only goes to the first decimal place (tenths).

Older Loran-C receivers display only a TD for each pair of stations. By matching these TD numbers to the Loran-C grid, overprinted on a chart, you determine an LOP. Intersecting two or more of these LOPs gives you a fix.

TDs represent specific intersecting grid lines on a Loran-C chart. Each line is labeled with a code such as SSO-W and SSO-Y that identifies particular master-secondary signals. Following the code is a number that corresponds to the TDs that would appear on a Loran receiver on a boat located along the line. Note the TDs and find the two intersecting grid lines; one on the SSO-W axis, the other on the SSO-Y Axis that most nearly match the readings on your boat's receiver.

The first step in plotting a Loran position is to match the numbers on the receiver with the Loran grid on the chart. The point where the two lines meet gives you a fix of your position.

7.2.2.4 Refining a Loran-C line of position

The following example illustrates the procedure to refine Loran-C LOPs. Refer to the accompanying figures for additional info.

Example:

You have two Loran readings: SSO-W-13405.0 and SSO-Y-56187.5. The first axis lies between SSO-W-13400.0 and SSO-W-13410.0 and the second axis lies between SSO-Y-56180.0 and SSO-Y-56190.0.

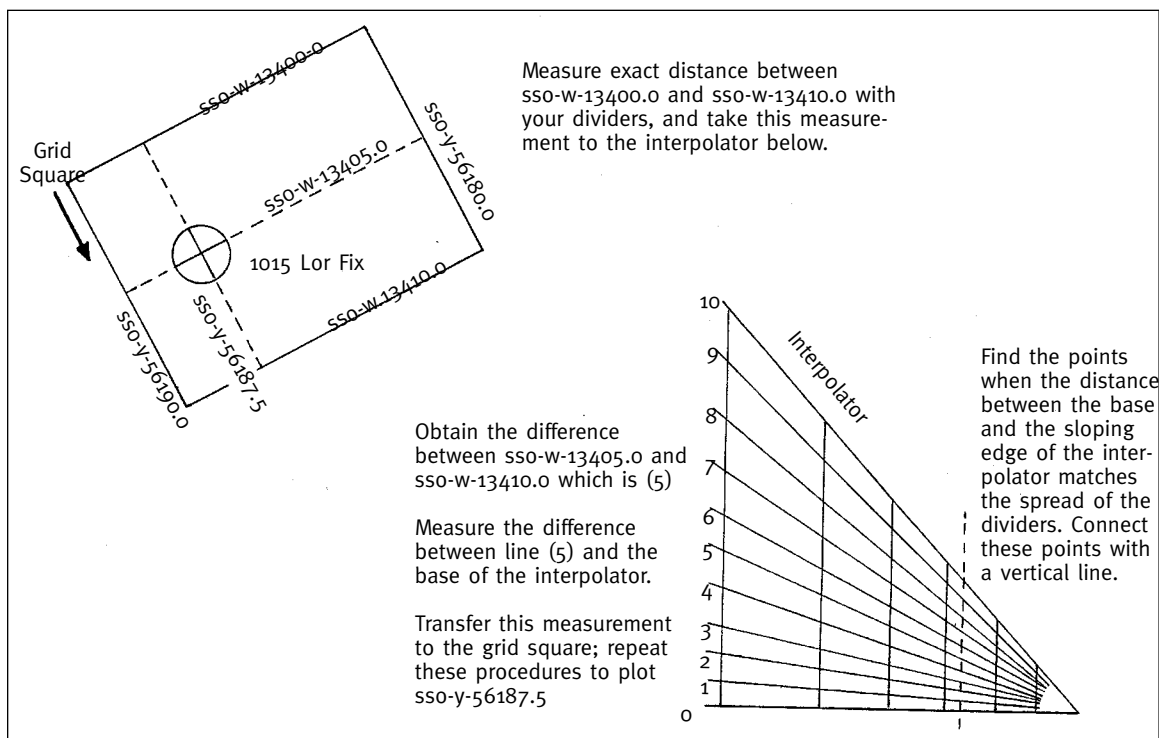

Figure 7.9: Obtaining a Loran fix on a grid square

Procedure to refine your Loran-C fix:

- Use dividers and measure the exact distance between the Loran lines of position SSO-W-13400.0 and SSO-W-13410.0 on your chart;
- Without changing the span of your dividers, find the points where the distance between the base of the wedge-shaped interpolator scale on the chart and the topmost sloping edge of the interpolator matches the span of the dividers. Connect these two points with a vertical line;
- Along the vertical edge of the interpolator are the numbers 0, 1, 2, 3, 4, 5, 6, 7, 8, 9, 10. Beginning at the base, read UP. Each number makes an immediate sloping line on the interpolator. The difference between SSO-W-13405.0 and SSO-W-18410.0 is five. Select line five of the interpolator and follow it to the vertical line drawn in the previous step;
- Take your dividers and measure the distance between line five and the base of the interpolator. Without changing the span of the dividers measure the same distance, away and perpendicular to the line SSO-W 13400.0 on the chart nearest your DR;
- Measure the direction toward the line SSO-W-3410.0. Take your parallel rulers and draw a line parallel to SSO-W-18400.0 at this point. Your SSO-W-13405.0 TD is now plotted;
- Plot the SSO-Y-56187.5 between SSO-Y-56180.0 and SSO-Y-56190.0 using the above procedure.

7.2.3 Global Positioning System (GPS)

The Global Positioning System (GPS) is a radionavigation system of 24 satellites operated by the United States Department of Defense (DoD). It is available 24 hours per day, worldwide, in all weather conditions. Each GPS satellite transmits its precise location, meaning position and elevation. In a process called “ranging,” a GPS receiver on the boat uses the signal to determine the distance between it and the satellite. Once the receiver has computed the range for at least four satellites, it processes a three dimensional position that is accurate to about 10 m.

7.2.3.1 Standard Positioning Service (SPS)

The SPS is available on a continuous basis to any user worldwide. It is accurate to a radius within 10 metres of the position shown on the receiver about 99% of the time.

7.2.3.2 Equipment features

GPS receivers are small, with small antennas and need little electrical features power. Hand-held units are available. Positional information is shown on a liquid crystal display (LCD) screen as geographical coordinates (latitude and longitude readings). These receivers are designed to be interfaced with other devices such as autopilots, EPIRBs and other distress alerting devices, to automatically provide position information. Navigational features available in the typical GPS:

- entry of waypoints and routes in advance;
- display of course and speed made good;
- display of cross-track error;
- availability of highly accurate time information.

7.2.3.3 Differential Global Positioning System (DGPS)

Differential Global Positioning System (DGPS) was developed to improve upon SPS signals of GPS. It uses a local reference receiver to correct errors in the standard GPS signals. These corrections are then broadcast and can be received by any user with a DGPS receiver. The corrections are applied within the user's receiver, providing mariners with a position that is accurate within 10 metres, with 99.7% probability. While DGPS is accurate to within 10 m, improvements to receivers will make DGPS accurate to within a centimetre, noise-free and able to provide real-time updates.

CHAPTER 8 – WAVES AND WEATHER

8.1	Wave theory	8-3
8.1.1	General	8-3
8.1.2	The parts of a propagating wave	8-3
8.1.3	Wave energy	8-5
8.1.4	Particle motion	8-7
8.1.5	Factors in creating shape	8-7
8.1.6	Breaking waves	8-10
8.1.7	Refraction and reflection	8-11
8.1.8	Combining wave fronts	8-12
8.1.9	Rip currents	8-12
8.1.10	Tsunamis	8-13
8.2	Understanding weather	8-14
8.2.1	General	8-14
8.2.2	The atmosphere – general concepts	8-15
8.2.3	Applied knowledge	8-16
8.2.4	Special weather conditions	8-16
8.2.4.1	Thunderstorms	8-16
8.2.4.2	Fog and snow	8-16
8.2.4.3	Icing	8-17
8.2.5	Maritime weather information	8-17
8.2.5.1	Maritime weather forecasts	8-17
8.2.5.2	Weather warnings	8-17
8.2.5.3	Effect of wind	8-18

8 WAVES AND WEATHER

8.1 WAVE THEORY

8.1.1 General

An understanding and appreciation of wave action is essential for a competent mariner. Understanding how waves form and behave at sea, over shoals and in the surf zone can help you to know what to expect and how to use a given situation to avoid or minimize danger to both vessel and crew.

The following definitions will assist in understanding the remainder of this section.

8.1.2 The parts of a propagating wave

Breaker

A single breaking wave of either the plunging type or the spilling type.

Breaker line

The outer limit of the surf. Breakers may not all present themselves in a line. Breakers can occur outside of the breaker line and seem to come from nowhere.

Comber

A wave on the point of breaking. A comber has a thin line of white water upon its crest, referred to as “leathering.”

Crest

The top of a wave, breaker or swell.

Fetch

The unobstructed distance covered by the wind blowing across the surface of the water.

Foam crest

Top of the foaming water that speeds toward the beach after the wave has broken, popularly known as white water.

Frequency

The number of crests passing a fixed point in a given time.

Interference

Waves that have been refracted or reflected can interact with each other as well as with the incoming waves, and may be additive (or subtractive), resulting in unnaturally high waves. Interference may even result in standing wave patterns (waves that consistently appear to peak in the same spot). Interference can be of particular concern because it may result in a boat being subjected to waves from unexpected directions and of unexpected size.

Period

The time it takes for two successive crests to pass a fixed point.

Series

A group of waves which seem to travel together at about the same speed.

Surf

A number of breakers in a continuous line.

Surf zone

The area near shore in which breaking occurs continuously in varying intensities.

Swell

Swells are the waves that have moved out of the area in which they were spawned. The crests have become lower, more rounded and symmetrical. In this form, they can travel for thousands of miles across deep water without much loss of energy.

Trough

The valley between waves.

Waves

Waves are periodic disturbances of the sea surface, caused by wind, earthquakes, and the gravitational pull of the moon and the sun.

Wave gradient

The slope or angle of a wave from its trough to its crest.

Wave height

The distance from the bottom of a wave's trough to the top of its crest.

Wave length

The distance from one wave crest to the next in the same wave group or series.

Wave reflection

Almost any obstacle can reflect part of a wave, including underwater barriers such as submerged reefs or bars, even though the main waves may seem to pass over them without change. These reflected waves move back towards the incoming waves. When the obstacles are vertical or nearly so, the waves may be reflected in their entirety.

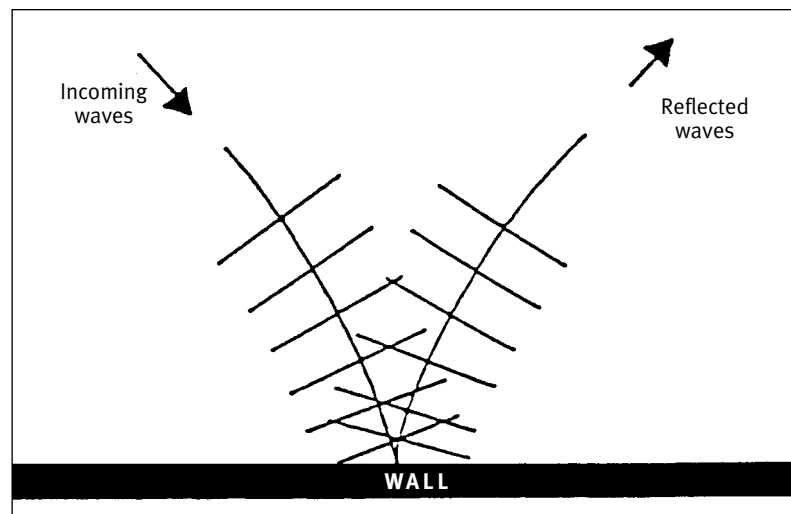

Figure 8.1: Wave reflection

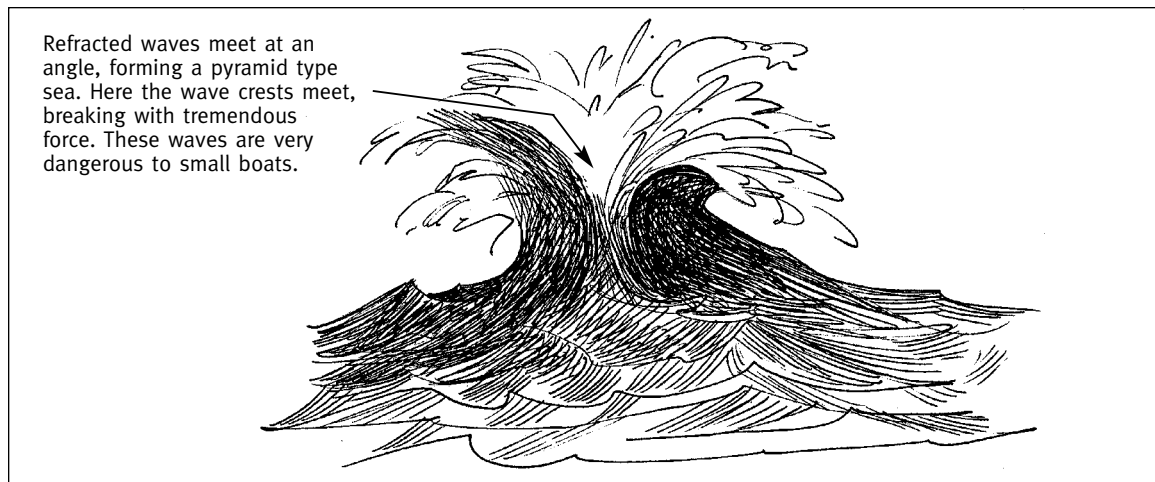

Figure 8.2: Wave refraction

Wave refraction

Refraction means bending. Wave refraction occurs when the wave moves into shoaling water, interacts with the bottom and slows down. Naturally, the first waves encountering the shallows slow down first, causing the crests of the waves to bend forward toward the shallower water. The bottom terrain determines how much refraction occurs. Refraction can also occur when a wave flows past a point of land, a jetty, or an island.

8.1.3 Wave energy

Waves are the visible result of an energy transfer process whereby energy is imparted to the water by displacing forces, usually caused by wind and vessel movement. The energy is transferred from these sources through the water until it is eventually expended by dispersion and decay, as breaking waves, or is transferred to the shore as surf. When waves are formed, certain forces immediately begin to act to bring the water's surface back to a level state. These forces are:

- gravity, which acts on the wave by forcing it to flow back down to a flattened position;
- surface tension, which resists wave formation; and
- elasticity, which resists any change in the total volume of the water. If the force which caused the wave to form were removed, the water's surface would eventually return to level because of internal friction, or by transfer of the energy to another medium, such as floating objects or the shore.

If there were no wave motion, the water would naturally lie at the Still Water Level (SWL).

As the figure shows:

- The depth of the water is measured from the SWL to the bottom;
- The top of the wave is called the crest. The lowest level between two successive wave crests is called the trough;
- The wave height (h) is the vertical distance between the highest and lowest points of a wave;
- The wavelength (l) is the horizontal distance between two successive crests. For the average wave system, this is measured in feet;

- The amplitude (a) is equal to one-half of the wave height;
- The crest angle is the angle formed by the sides of the wave at the crest;
- The steepness of the wave is measured by dividing the height by the length (h/l);
- The wave period (t) is the time interval, in seconds, between one crest and the next from a fixed observation point.

The speed of the wave motion, phase motion (C), is computed by dividing the wavelength by the period, or $C=L/T$.

The slope (S) of the bottom is an important factor in the wave's steepness. The slope is equal to the vertical change in bottom depth divided by the horizontal distance in which the depth change occurs. Both the wave steepness and the slope of the bottom are important factors in breaking waves and surf conditions.

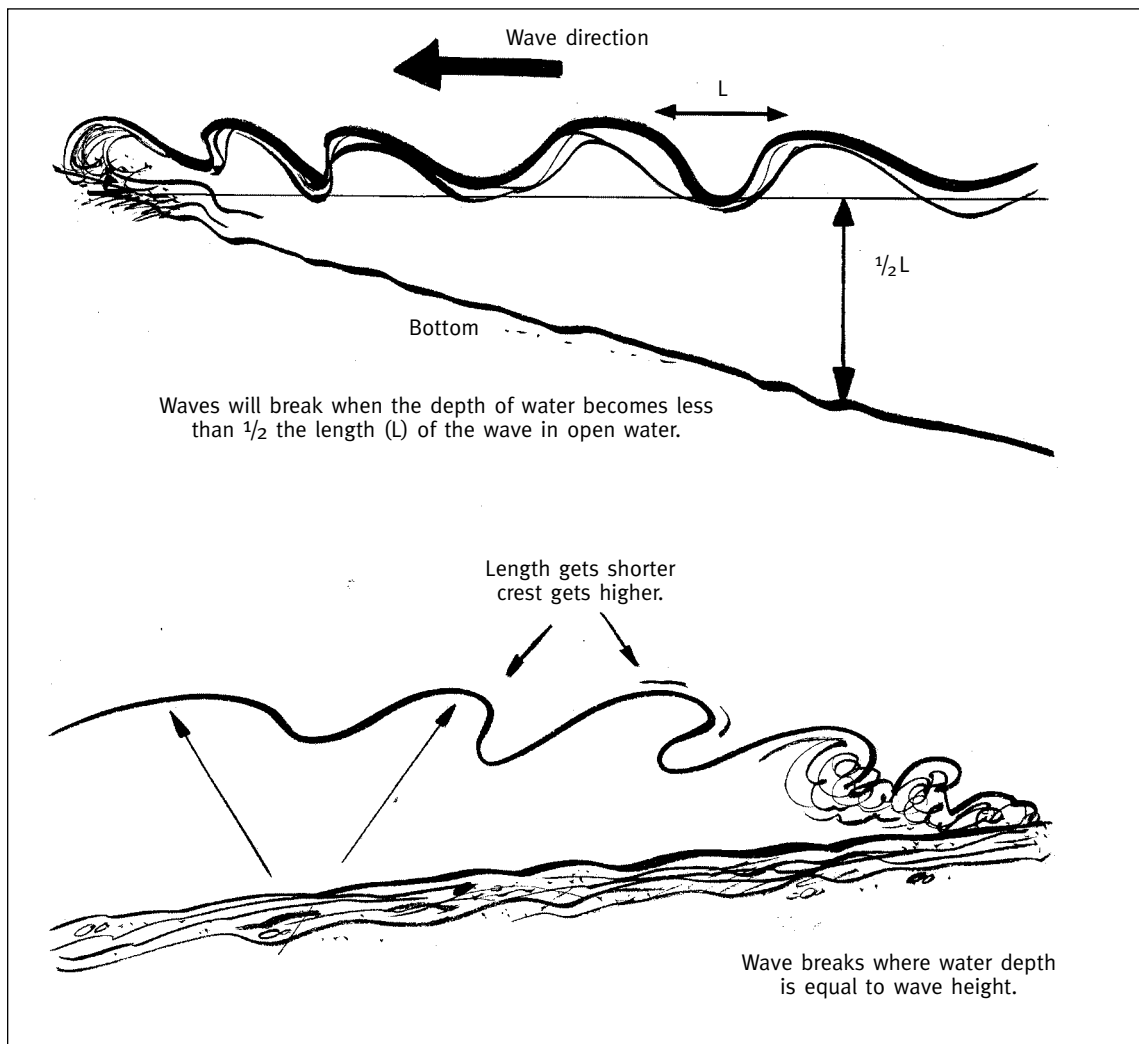

Figure 8.3: Surf

8.1.4 Particle motion

As a wave moves through the water, very little water is actually displaced any distance. Rather, the motion that occurs within the wave is circular in shape (orbital motion). At the wave's crest, the water moves forward at a maximum speed in the horizontal direction of the wave's progress. Halfway down the face on the front of the wave, motion is upward. At the bottom of the trough, it is moving at maximum speed, backward, in the horizontal direction opposite that of the wave's progress. On the rear face of the wave, halfway up from the trough to the crest, it is moving downward, at its maximum speed in the vertical direction. It is this motion which allows a wave to approach a floating object, flow under it and move on while leaving the object in the same place. Remember, it is current and/or wind which moves an object through the water, not the wave.

8.1.5 Factors in creating shape

When the wind imparts its energy to the sea's surface, the amount of energy transferred, and thus the eventual characteristics of the waves generated, depend upon the wind's strength and how long it acts upon the water.

Ocean currents may further affect the shape of the wave. An opposing current will steepen the wave and increase the height while reducing the wavelength. A following current will increase the wavelength and decrease height.

The unimpeded length of the water area over which the wind blows is called the fetch. If the body of water happens to be a lake ten miles long, and the wind blows down its length, the waves generated on the lake have a fetch of 10 miles. If, however, winds blow across the same lake, and it is only five miles wide, the fetch of these waves would be five miles. When wind waves are generated at sea, the fetch may be several thousand miles long. For such long fetches in the ocean, the wind can act for a very long time in the same direction over a vast expanse. In such cases, sea wind waves can receive much energy and grow to immense size. If a large storm such as a hurricane or typhoon is the source of the wind, the resulting waves can be enormous and travel for tremendous distances before they dissipate their energy on some distant shore as surf. Wind waves can be classified into two distinct types that are of major interest to the maritimer:

- When the depth of the water is greater than about one-third of the wavelength, the bottom has little effect on the wave, and it is termed a deep water wave;
- When the depth of the water is less than one eleventh of the wavelength, it is termed a shallow water wave, and the wave is strongly affected by the bottom.

A third class of waves, intermediate waves, are found between these two classes, but an explanation of these waves would be very complicated and beyond the scope of this manual.

As the wind continues to affect a deep-water wave, the wave will continue to grow until its steepness and crest angle approach a critical state, at which point the wave becomes unstable and breaks. These storm-tossed and breaking waves are termed seas while they are still being generated. Deep-water waves originating far out at sea may have wavelengths of

hundreds or thousands of feet, periods of many seconds and a speed of advance of dozens of feet per second.

After the deep water waves are generated far out at sea, they move outward, away from their wind source, in ever-increasing curves, and become what is called swells. The further the swell moves from its source, the more uniform its characteristics become, as it travels in a series of relatively equidistant waves moving at a fairly constant speed. Because of this, the smoothness and uniformity of the swells generated from storms far out at sea distinguish them from those which are more coarse (peaked and irregular) and have recently originated nearby. The usual period of these swells is from 6 to 10 seconds. The wavelengths are of 56 to 400 m (184 to 1,310 ft.) and have velocities of 18 to 49 knots.

Interference between different swell systems traveling in nearly the same direction causes groups of waves to travel outward in patches. As these groups of several waves (normally 7 to 12) progress outward, the waves in the forefront disappear and new waves, of the same characteristics, appear at the rear of the patch. This process continues until the waves dissipate their energy at sea or transfer it to the shore as surf.

Knowledge of the characteristic clustering of waves into groups is useful during operations in shoaling waters such as over bars, in inlets, or working in surf. The wave groups can be observed and their group periods determined. The boat or boats can be best manoeuvred while the wave motion is at a minimum, during the space between groups.

When deep-water waves move into shallow waters, the waves are influenced by the bottom, becoming shallow water waves. In the approach to shore, the interaction with the bottom causes the wave speed to decrease. This decrease causes refraction, and one effect is to shorten the wavelength. As the wavelength decreases, the wave steepness increases and the wave becomes less stable.

Also, as the wave moves into water whose depth is about twice the wave's height, the crest peaks up; that is, the rounded crest of a swell becomes a higher more pointed mass of water with steeper sides. This change of waveform becomes more pronounced as the wave moves farther into shallow water. These changes in wavelength and steepness occur before breaking. Finally, at a water depth roughly equal to 1.3 times the wave height (the actual formula used to determine when the wave will break is $H=0.8d$, i.e. the point when height is equal to 80% of depth ratio), the wave becomes unstable. This happens when not enough water is available in the shallow area ahead to complete the crest and the wave's symmetrical form. The top of the onrushing crest is left unsupported and collapses. The wave breaks, resulting in surf.

The motion of the water that occurs within shallow water waves is no longer circular, but tends to become elliptical. Unlike the orbital motion of deep-water waves, these orbits do not decay with depth.

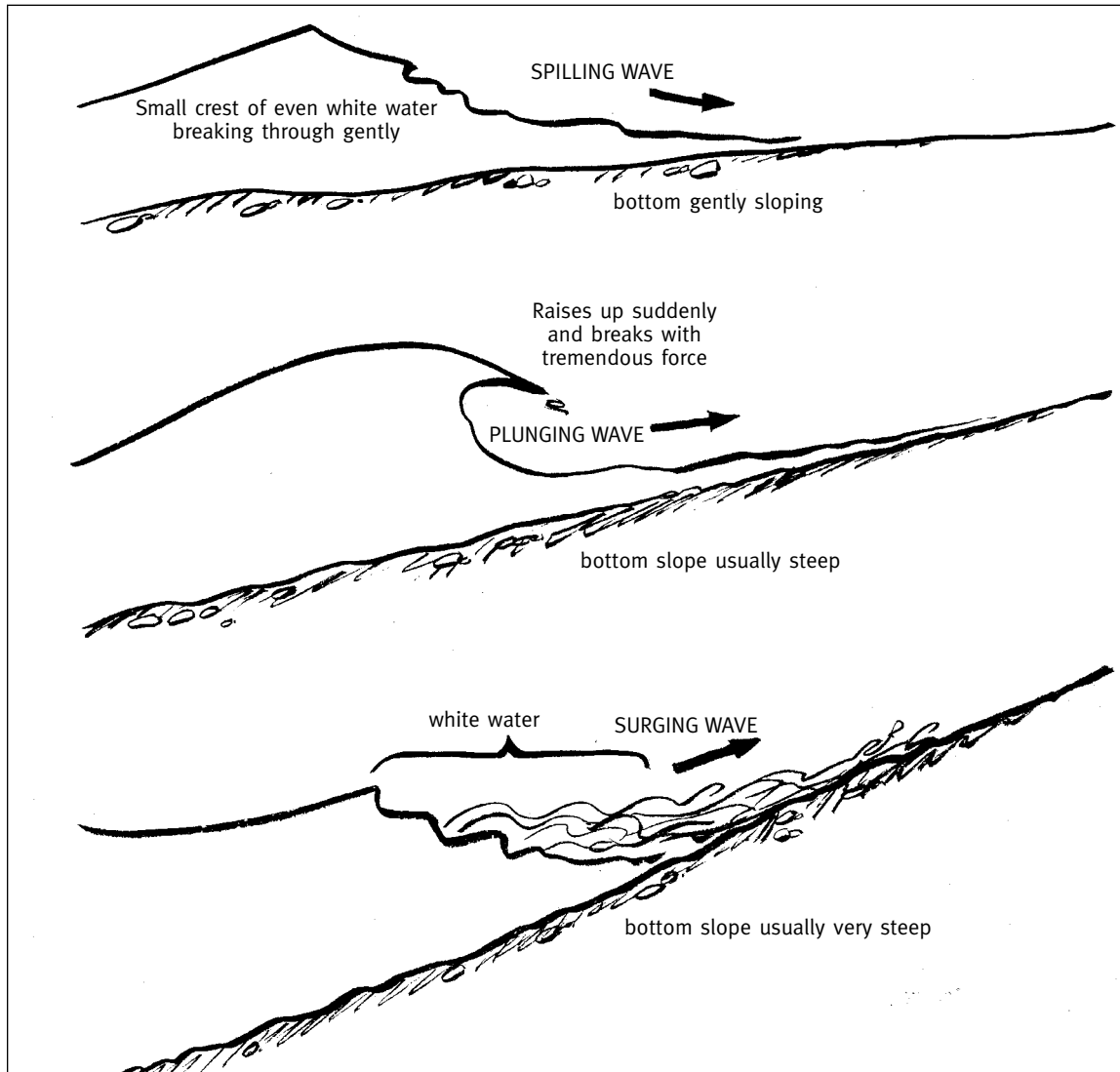

Figure 8.4: Spilling, plunging and surging waves

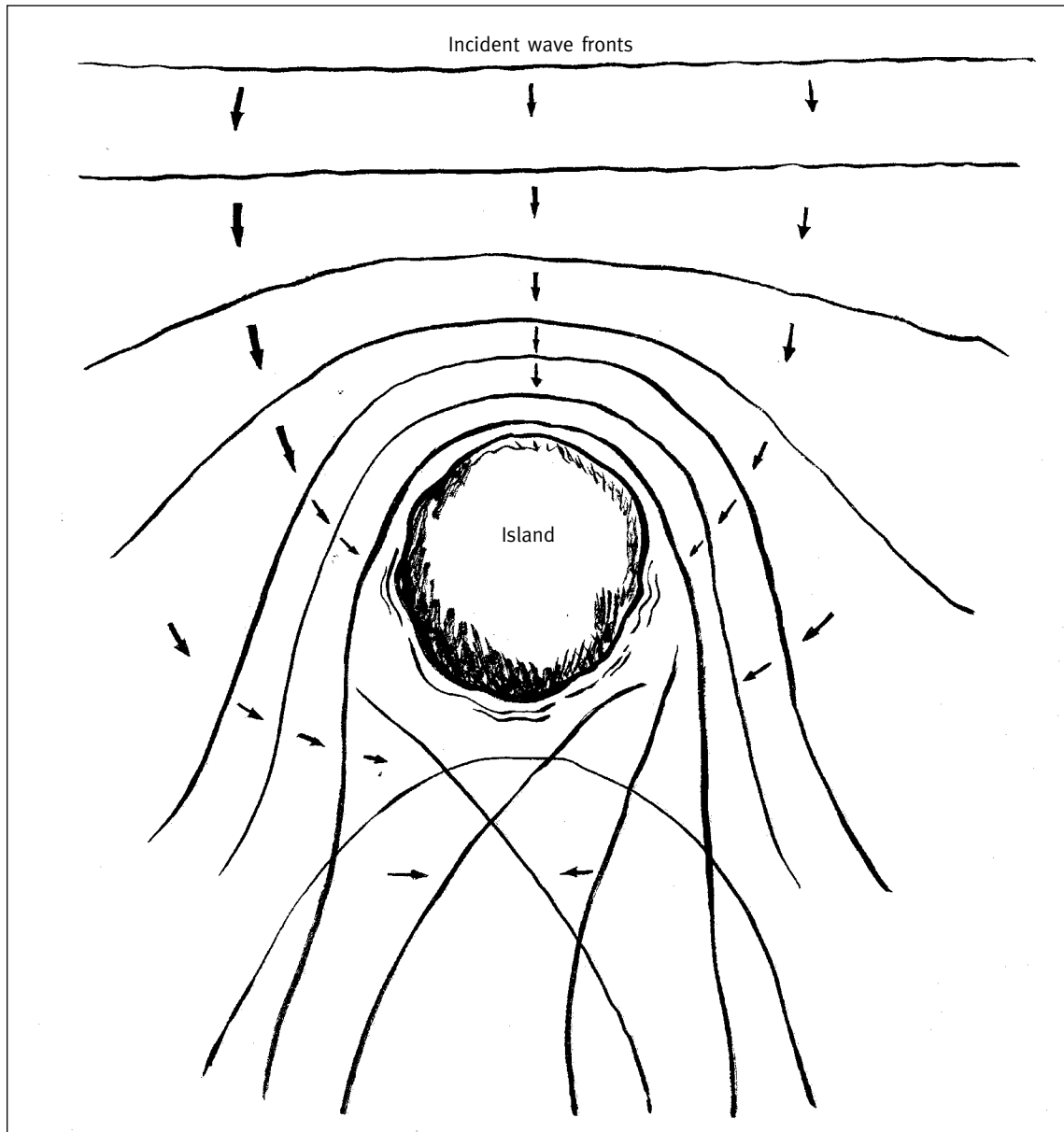

Figure 8.5: *Effect of an island on incoming waves*

8.1.6 Breaking waves

There are multiple degrees of breaking intensity, depending upon the deep-water steepness of the incoming wave and the slope of the beach or shoal area. Over very gradual slopes, the wave begins to break in a gentle spilling action that dissipates just enough energy to keep the “80% of the depth” ratio constant as the wave moves toward the shore or over the shoal. This kind of breaking action is termed spilling, and is characterized by white water at the crest of the wave. It is the beginning of the phenomenon called surf. The area near shore in which breaking occurs continuously in various intensities is called the surf zone. Vessels engaged in SAR should never go into a surf zone. Many SAR crews have been seriously injured and some have been killed in surf zones. Be extremely careful, since surf zones are more readily visible from the shore than from the sea.

As the underwater slopes become steeper, breaking becomes more intense, and fewer waves break simultaneously. The waves begin to curl as the orbital velocities of the individual water particles at the crest rise with increasing height. When not enough water is available in the shallow water ahead of the wave to fill in the crest and complete a symmetrical wave form, the top of the onrushing crest is unsupported and plunges ahead as an incomplete orbit. This type of breaker is termed plunging. In plunging surf, only one wave breaks at a time, and its intensity is greatly increased by the backwash of the wave that broke before it. Obviously, this is not a good place to operate a vessel. Remember, water is heavy, about one ton per cubic yard. A breaking wave could dump tons of water on you, swamping and/or severely damaging your boat.

When the beach slope exceeds the wave steepness, the breaker builds up as if to form a plunging breaker, but the base of the wave surges up on the beach before the crest can plunge forward. This form of breaker is termed surging. When the depth ratio approaches about 1.2 (that is, $l/d=1.2$), the limit of breaking at the shoreline is reached, and all similar waves will surge up steeper slopes without breaking at all.

If the slope of the beach is uniform, the effect of the tide would be to move the entire surf zone in (on a high tide) or out (on a low tide) with little other change. On an offshore bar, or in an inlet with a bar, the changing tide modifies the depth of the water, and the bottom thus influences incoming waves. Breaking waves and surf may form over these shoaling waters at low tide, whereas no such action is present at higher tides.

Current can affect speed of wave movement through the water. When the current is against the wave direction, it acts to reduce the wave's speed, and thus increases the wave's steepness. In this case, the wavelength decreases and the height increases. The result is breaking where it was not occurring before, or more violent surf. Certainly, tidal height and currents should be considered when surf is a possibility.

As indicated earlier, wave characteristics are modified when deep-water waves make the transition to shallow-water waves. As depth decreases, so do wave length and speed of advance, (while the wave period remains constant) and the result is called refraction, in which the wave front (the line of the crest) bends or curves toward the shallows. If the wave crests are approaching the shoreline at an angle, they will be curved toward the slope by refraction of the wave front by the bottom, and eventually arrive nearly parallel to the shoreline.

8.1.7 Refraction and reflection

Refraction causes divergence (moving away) and results in lower waves over offshore troughs and holes on the bottom. It also causes convergence (coming together) and higher waves over ridges and shoals on the bottom.

Refraction can occur around islands with sloping shores, too, and cause the wave fronts to "wrap around" the island, creating a shadow zone, confused seas, and even focused wave energy at a distant shoreline point.

8.1.8 Combining wave fronts

When two or more wave fronts interact, or when a fast-moving wave overtakes a slower one, the resulting effect is called interference. When the water in each of these waves is moving in the same direction at the point of interaction, the motion accumulates and the result is an increase in the wave motion at that point. The wave height also increases, and constructive interference occurs. When the respective water particles are moving in opposite directions at the point of interaction, they act destructively, and may even cancel each other's motion out. This is called destructive interference. Obviously, interference can result in a considerable increase in wave motion and change relatively moderate swells into breaking waves at the points of crossing or collision. Interference can also cause the waves to be suddenly stilled, or reduced, making the location much calmer and possibly useful as a point at which to enter or leave the water in relative safety.

When a wave front bounces off a deep vertical surface, such as the face of a sea cliff or the side of a breakwater, or even a very steeply sloped beach, the wave energy may be turned back or diverted in some other direction. This process is termed reflection. If the reflected waves react with the oncoming waves, causing constructive interference, the resulting wave motion can be intensified. If the conditions are just right, standing waves may be formed, in which the water particles move up and down under the wave crests and back and forth at the mid points of the trough. Both the crests and troughs remain in the same horizontal location: the progress of the wave is essentially terminated.

When a wave front travels between two close islands, or through a gap in a breakwater, the waves produce very complicated interference patterns by the process of diffraction, particularly when they approach the gap at an angle. When this happens, the wave height within the area beyond the breakwater gap may exceed that of the wave outside of the breakwater.

In towing operations off a beach where there is running surf, rip currents (more popularly and incorrectly called "rip tides" or "undertows") can be used to great advantage. Rip currents are produced as a result of the movement of large volumes of water by waves or surf upon the beach face. The raised level of water produced by the waves on the beach flows away in what is called a longshore current parallel to the beach and in the same general direction as the waves as they angle in on the shoreline.

8.1.9 Rip currents

If the wave fronts or crests are running parallel to the beach, the longshore current can flow up or down the beach. Such longshore currents can have magnitudes of several knots. As the longshore currents flow along the beach, they reach points where, for various reasons, the water returns to the sea. Rip currents made up of this outflowing water are produced at these points. Channels, sometimes with steep sides, are produced by these rip currents. Although rip currents may become dangerous to swimmers, a knowledgeable boater can use them to advantage.

At the rip currents, the breakers are usually smaller because of refraction (decrease in wavelength and speed where the wave curves or bends). Both the deep water in the channels and

the decreased breaker height are helpful to a small craft manoeuvring in the surf zone. Furthermore, the outflowing current can be substantial, approaching several knots, and can substantially assist in moving a towing vessel and the tow rapidly out to safer waters.

Rip currents can be easily recognized from the beach. The observer can generally see a place where the waves are breaking less actively because of the deeper water. The rip current has highly agitated water with small, slapping waves. Sometimes roll-up water being carried out along the rip current can be seen in contrast to the cleaner water on either side. The colour of the turbid water extending out along the course of the rip can be seen from the seaward side. Often there is also a concentration of foam that develops along the boundary of the outward surging masses in the rip current.

Remember, there is no relation between a “rip tide” and a “tide rip.” A tide (or tidal) rip is caused by a swift tidal current flowing over a rough bottom. If this current meets an opposing wave, a violent reaction occurs, causing the water to shoot into the air. This area is to be avoided.

Wind is not the only energy source that creates wave motion on the surface of the sea. Severe and sudden displacements (uplift and subsidence) of the ocean floor during earthquakes can inject huge amounts of energy into the water in the form of short, impulsive disturbances. These impulses generate waves that are popularly but incorrectly called tidal waves. Their correct name is tsunamis (sue-naa-me), or seismic sea waves. Tsunamis radiate in all directions as a system of shallow-water waves, with rings of waves spreading out like the pattern created by a stone dropped in a calm pond. The longest wave is at the front, the leading edge of the system, with shorter waves following. The velocity of the leading wave is very high and is limited only by the depth of the water. Each tsunami wave front retains its identity as it moves away from the source area with its height slowly decreasing as the energy is dissipated by the circular spreading from the source.

8.1.10 Tsunamis

Tsunami waves may travel thousands of miles, moving very rapidly on the sea surface. Contrary to popular belief (and the movies), the tsunami waves on the high seas have very little height (0.3 to 0.6 m / 1 to 2 ft.) and very long wave lengths (50-250 miles) with periods of more than 15 minutes. Given these characteristics and the ever-present swells, the wave is imperceptible. Thus, tsunamis at sea are rarely noticed. They race by ships at sea, which remain totally unaware of their presence. Indeed, tsunami characteristics are very difficult to measure at sea, even with sophisticated instrumentation and advance knowledge of their approach.

Tsunamis are of greatest concern, and most dangerous, when, behaving like the shallow water waves that they are, they enter areas with sloping shores and shoaling waters. Here, because of the influence of the bottom topography causing refraction, reflection, diffraction, interference, rapid cresting and breaking, they are modified and enhanced to form tremendous waves that flow over harbors and nearby shore areas with devastating results.

Coastal regions which have a relatively wide, shallow, offshore shelf, such as southern California, experience much less intense wave action from tsunamis than areas such as Hawaii and Japan, where shores slope steeply to great depths. Local activity depends very much on bottom topography and orientation with respect to the incident wave front. Most of the devastation from tsunamis occurs as the first and largest of the waves arrives. Following the initial wave, the surge intensity gradually diminishes, although oscillations can be detected on tidal measuring instruments for several days.

Wave facts

- The longest waves in the world are the lunar tides that sweep across the oceans with periods of between 12 and 24 hours;
- The highest wave ever recorded was near Juneau, Alaska, in 1958. The wave was caused by a massive fall of rock into an enclosed inlet and measured 525 m high (1,720 ft.);
- The most people ever killed by a single wave was in East Pakistan (Bangladesh) in 1970. Between 300,000 and 500,000 people perished when a 15 m (50-ft.) storm wave devastated the low-lying coastline;
- The highest wind-generated wave ever accurately assessed at sea was aboard the USS Ramapo on February 6, 1933. The wave was measured at 34 m high (112 ft.). The ship was on passage from Manila, Philippines, to California during a hurricane. The wind force was measured at 68 knots;
- The most powerful tsunami ever recorded in modern times originated on the Island of Krakatoa near Sumatra in Indonesia. The tsunami was generated when the Mount Perboewaten volcano (thought to be extinct) exploded on August 27, 1883. The wave was over 40 m (130 ft.) when generated and advanced at speeds up to 700 mph across deep oceans. The shock waves circled the world seven times, once every 36 hours. The sea level in San Francisco Bay, 11,000 miles away, was affected. The sound from the massive explosion was heard in Perth, Western Australia nearly 2,000 miles from the volcano.

8.2 UNDERSTANDING WEATHER

8.2.1 General

Each day, millions of people begin their day by looking out the window or reading or listening to weather forecasts to see what the weather is like. Knowing what kind of weather to expect in the next hours or days is essential for planning any kind of outdoor activity. In SAR operations, knowing the weather is often much more than convenient: it may very well become a survival issue. Knowing that things will become nasty provides the opportunity to prepare for the worst and bring additional equipment (e.g., raingear, boots or dry suits).

Over the past decade, tremendous advances have been made in the field of computing. With the increased capabilities of today's computers, it is now feasible to achieve quite accurate forecasts. But nature will continue to surprise us: it is impossible to predict every local phenomenon. Published forecasts offer useful information about the general weather

for the day in a given area. But there are also several accurate tricks for determining what the weather may look like within the next 30 minutes. This section will explain some of the tricks that can be used to your advantage in your daily operations.

8.2.2 The atmosphere – general concepts

One of the important characteristics of gas is that it is compressible. Air can be compressed, and when it is, the density of the gas increases and so does the barometric pressure. Another thing that can affect the density of gases is temperature. When the temperature of a gas increases, its density decreases (the gas becomes lighter and the barometric pressure decreases). When the temperature decreases, density increases (the gas becomes heavier and the barometric pressure increases).

Another important property of air is its capacity to hold water vapour. The amount of water vapour that air can hold is influenced by temperature. Hot air can hold more water vapour than cold air. This explains why air is drier during winter. The term “relative humidity” is used to express how much water vapour is present. Relative humidity is a percentage (%). At 100% relative humidity, the air is completely saturated with water vapour. At 0%, absolutely no water vapour is present: the air is completely dry.

Consider, for example, the origin of rain (or any other form of precipitation). Imagine hot air at 99% relative humidity. Clouds form and eventually cover the whole sky. Since the sun can no longer reach the land, the temperature will drop. As the temperature decreases, so does the “water-holding capacity” of the air, and soon, too much water vapour is present in the air. This water vapour thus condenses to form small droplets. These will then become too heavy to remain suspended in the air, and will eventually fall. This phenomenon explains why high-pressure systems are associated with clear skies and low probabilities of rain, while low-pressure systems are associated with clouds and high probability of rain.

Winds are caused by movements of gaseous masses. Many factors may influence wind strength and direction. The rotation of the earth is one factor. It is the key factor in determining the average direction of wind (dominant wind direction). Local factors can also be involved. One such important factor is, once again, temperature. Hot air has a tendency to rise, while cold air has a tendency to sink. When a layer of hot air rises, a vacuum effect is produced. Air in the surroundings will rush toward this vacuum to take the place of the now elevated hot air. This is one of the ways in which winds are produced. On the other hand, the cooling of an air mass will cause it to drop toward the ground. As this occurs, air is displaced and wind will result. When air masses are displaced in this manner, the barometric pressure will respectively decrease or increase rapidly. The quicker the change in barometric pressure, the stronger the winds.

Another means by which wind can be produced is the movement of two air masses. When two air masses meet, they can slide onto each other or displace each other. In both cases, winds may result.

8.2.3 Applied knowledge

These explanations represent a very limited portion of weather science. While they may not transform you into an expert, they should help you to understand how you can predict major meteorological events a few minutes in advance.

The following paragraphs will tell you what to expect from what you observe. This knowledge may help you to be ready for the worst instead of being caught by surprise.

Expect cloudy skies and uncertain weather when:

- barometric pressure decreases;
- night temperature is higher than usual;
- clouds are moving in different directions at different altitudes;
- small hair-like clouds are present high up in the sky;
- in summertime, clouds turn dark in the afternoon.

Expect showers when cumuli (small cotton wool-like clouds) form rapidly in early afternoon (spring or summertime).

Expect good weather when:

- barometric pressure rises;
- temperature decreases rapidly during the afternoon.

Expect prolonged good weather when:

- the setting sun is like a fire ball and you can look at it directly;
- barometric pressure remains constant or rises slowly;
- morning fog dissipates within two hours of sunrise;
- the sun turns red when it sets.

8.2.4 Special weather conditions

8.2.4.1 Thunderstorms

The strongest winds in a thunderstorm usually precede the storm centre itself, in a zone up to three miles long. Gusts up to 50 knots can be expected in this zone. The winds blow downwards from the cloud, and they are especially dangerous for small vessels.

The heaviest rain occurs directly under the thunder cloud, leading to poor visibility. Heavy rain lasts from five to 15 minutes. Thunderstorms normally last less than one hour.

Waterspouts may occur during a thunderstorm. A waterspout is a funnel of cloud reaching from the base of the thunderstorm cloud to the water, which may suck up water into the air. It usually lasts less than 15 minutes. Although immature waterspouts may be very small, they can become extremely violent without warning.

8.2.4.2 Fog and snow

Fog is a common problem at sea. The major hazard is reduced visibility. Vessels should proceed with caution. Monitor radar carefully if possible.

Snow also reduces visibility, and can be especially hazardous if it falls as melting snow. Melting snow not only reduces visibility, but interferes with radar signals, making radar less effective. This usually occurs during arctic air outbreaks, and is a serious problem in mainland inlets.

8.2.4.3 Icing

Accumulations of ice on a vessel may lead to serious stability problems. Substantial icing can occur when temperatures are between -3 and -8°C with winds of 16-30 knots. The danger increases with colder temperatures or stronger winds.

Freezing sea spray is the most common and the most hazardous form of icing. Spray blown by winds can cause heavy icing on a vessel, producing a heavy list. Freezing spray usually occurs when the air temperature is less than -2°C , and the water is less than 5°C . Freezing spray warnings are included in maritime weather forecasts.

With freezing rain, a film of ice forms over the deck railings and stairways. This form of icing is the least likely to cause stability problems, but it can be a serious hazard for the crew moving on deck.

A similar glaze of ice can be caused by sea smoke. Sea smoke forms when very cold air moves over warmer water, and it can freeze on contact with the vessel. It is not usually a severe problem, but if the sea smoke is very dense, substantial ice may accumulate.

8.2.5 Maritime weather information

8.2.5.1 Maritime weather forecasts

Maritime weather forecasts are available on:

- VHF Channel 21B, 25B and 83B (Atlantic Coast and Great Lakes);
- VHF Channel 21B and WX1, WX2, WX3 (Pacific Coast);
- Environment Canada Weatheradio VHF broadcasts in Vancouver, Toronto, Montréal and Atlantic Canada;
- regular AM and FM radio weather forecasts;
- the Maritime Weather Services Bulletin, obtained by calling the nearest Environment Canada weather office;
- MAFOR Code on the Great Lakes and St. Lawrence River.

A receiver for continuous weather forecasts is available on the market through maritime supply outlets.

8.2.5.2 Weather warnings

Maritime weather forecasts include four types of severe weather warnings: small craft, gale, storm, and hurricane force winds. The meanings of these warnings are:

- Small Craft Warning: winds 20-33 knots and wave heights 2-3 m (7-10 ft.);
- Gale Warning: winds 34-47 knots and wave heights 6-9 m (20-30 ft.);
- Storm Warning: winds 48-63 knots and wave heights 9-16 m (30-52 ft.);
- Hurricane Force Warning: winds 64 knots and over; wave heights over 16 m (52 ft.).

8.2.5.3 Effect of wind

In the maritime environment, wind speed is usually expressed in knots or as a unit of the Beaufort scale. The following table shows the two methods.

Table 8.1: The Beaufort scale

Beaufort wind force	Mean wind speed in knots	Limits of wind speed in knots	Descriptive term	Sea criterion	Probable height of waves in metres*	Probable maximum height of waves in metres*
	Measured at a height of 10 m above sea level					
0	00	< 1	Calm	Sea like a mirror.	–	–
1	02	1-3	Light air	Ripples with the appearance of scales are formed, but without foam crests.	0.1	0.1
2	05	4-6	Light breeze	Small wavelets, still short but more pronounced, crests have a glassy appearance and do not break.	0.2	0.3
3	09	7-10	Gentle breeze	Large wavelets. Crests begin to break. Foam or glassy appearance. Perhaps scattered white horses.	0.6	1.0
4	13	11-16	Moderate breeze	Small waves, becoming longer; fairly frequent white horses.	1.0	1.5
5	19	17-21	Fresh breeze	Moderate waves, taking a more pronounced long form; many white horses are formed. (Chance of some spray.)	2.0	2.5
6	24	22-27	Strong breeze	Large waves begin to form; the white foam crests are more extensive everywhere. (Probably some spray.)	3.0	4.0
7	30	28-33	Near gale	Sea heaps up and white foam from breaking waves begins to be blown in streaks along the direction of the wind.	4.0	5.5
8	37	34-40	Gale	Moderately high waves of greater length; the edges of crests begin to break into spindrift. The foam is blown in well-marked streaks along the direction of the wind.	5.5	7.5
9	44	41-47	Strong gale	High waves. Dense streaks of foam along the direction of the wind. Crests begin to topple, tumble and roll over. Spray may affect visibility.	7.0	10.0
10	52	48-55	Storm	Very high waves with long overhanging crests. The resulting foam in great patches is blown in dense white streaks along the direction of the wind. The whole surface of the sea takes a white appearance. Tumbling of the sea becomes heavy and shock-like. Visibility affected.	9.0	12.5
11	60	56-63	Violent storm	Exceptionally high waves. (Small and medium ships may be lost to view behind the waves for a time.) The sea is completely covered with long white patches of foam lying along the direction of the wind. Everywhere the edges of the wave's crests are blown into froth. Visibility affected.	11.5	16.0
12	–	> 64	Hurricane	The air is filled with foam and spray. Sea completely white with driving spray; visibility is seriously affected.	> 14	–

* These columns are added as a guide to show roughly what may be expected in the open sea, remote from land. In enclosed waters, or when near land off-shore wind, wave heights will be smaller, and the water steeper.

Another effect of wind is cooling. The greater the wind, the greater the cooling effect. Vessels engaged in SAR should remember that when a vessel is going at speed, hot days may become considerably cooler. The following chart expresses the cooling effect of the wind with an equivalent temperature.

Table 8.2: The cooling effect of wind

Estimated wind speed (knots)	Actual thermometer reading (°C/°F)									
	50/10	40/4	30/-1	20/-7	10/-12	0/-18	-10/-23	-20/-28	-30/-34	-40/-40
	Equivalent chill temperature (°F/°C)									
Calm	50/10	40/4	30/-1	20/-7	10/-12	0/-18	-10/-23	-20/-28	-30/-34	-40/-40
0-5	48/9	37/3	27/-3	16/-9	6/-14	-5/-21	-15/-26	-26/-32	-36/-38	-47/-44
5-10	40/4	28/-2	16/-9	4/-16	-9/-23	-24/-31	-33/-36	-46/-43	-58/-50	-70/-57
10-15	36/2	22/-6	9/-13	-5/-20	-18/-28	-32/-36	-45/-43	-58/-50	-72/-58	-85/-65
15-20	32/0	18/-8	4/-16	-10/-23	-25/-31	-39/-39	-53/-47	-67/-55	-82/-63	-96/-71
20-25	30/-1	16/-9	0/-18	-15/-26	-29/-34	-44/-42	-59/-51	-74/-59	-88/-67	-104/-76
25-30	28/-2	13/-11	-2/-19	-18/-27	-33/-36	-48/-44	-63/-53	-79/-62	-94/-70	-109/-78
30-35	27/-3	11/-12	-4/-20	-21/-29	-35/-37	-51/-46	-66/-54	-82/-63	-98/-72	-113/-81
35-40	26/-3	10/-12	-6/-21	-21/-29	-37/-38	-53/-47	-69/-56	-85/-65	-100/-73	-116/-82
Wind speeds greater than 40 knots will have little additional effect	Little danger of frostbite. Moderate danger for hypothermia after prolonged exposure.			Moderate danger of frostbite. Exposed flesh may freeze within 1 minute.			Extreme danger. Flesh may freeze within 30 seconds.			

Note: The equivalent chill temperature represents the temperature that would cause the same rate of cooling under calm conditions. Regardless of the cooling rate, humans do not cool below the actual air temperature unless they are wet.

CHAPTER 9 – BOAT HANDLING

9.1	General	9-5
9.2	The art of boat handling	9-5
9.3	Environmental forces acting on a boat	9-6
9.3.1	Winds	9-6
9.3.2	Seas	9-7
9.3.3	Current	9-7
9.3.4	Combined environmental forces	9-8
9.4	Propulsion and steering	9-9
9.4.1	Shaft, propeller and rudder	9-10
9.4.1.1	Propeller action	9-10
9.4.1.2	Propeller current	9-11
9.4.1.3	Side force	9-11
9.4.1.4	Cavitation	9-12
9.4.1.5	Rudder action	9-12
9.4.2	Outboard motors and stern drives	9-13
9.4.2.1	Thrust and direction control	9-14
9.4.2.2	Propeller side force	9-14
9.4.2.3	Vertical thrust	9-15
9.4.2.4	Cavitation	9-15
9.4.3	Waterjets	9-15
9.4.3.1	Thrust and direction control	9-16
9.4.3.2	No side force	9-16
9.4.3.3	Cavitation	9-16
9.5	Boat handling characteristics	9-17
9.5.1	Inherent handling characteristics	9-17
9.5.2	Single propeller characteristics	9-17
9.5.2.1	Dead in the water	9-17
9.5.2.2	Right-hand propeller – ahead	9-17
9.5.2.3	Right hand propeller – astern	9-18
9.5.2.4	Rudder position – backing	9-18

9.5.3	Twin propeller characteristics	9-18
9.5.3.1	Port Propeller Stopped	9-19
9.5.3.2	Starboard propeller stopped	9-19
9.5.3.3	Twin propeller pivot turn	9-19
9.5.3.4	Twin propeller steering	9-19
9.5.4	Outboard and I/O characteristics	9-20
9.5.4.1	Major differences	9-20
9.6	Types of hulls	9-21
9.6.1	Displacement hulls	9-21
9.6.1.1	Wave drag and theoretical hull speed	9-21
9.6.2	Semi-planing hulls	9-22
9.6.3	Planing	9-23
9.6.3.1	What is planing?	9-23
9.6.3.2	Trim angle	9-25
9.6.3.3	The evolution of v-bottomed hulls	9-26
9.6.3.4	Heeling and stability	9-27
9.7	Basic boat handling techniques	9-28
9.7.1	Leaving the dock	9-28
9.7.1.1	Prior to getting underway	9-28
9.7.1.2	Getting underway	9-28
9.7.1.3	Leaving the dock	9-28
9.7.1.4	Clearing a berth	9-30
9.7.2	On board procedures on fast units	9-31
9.7.2.1	Accelerating	9-31
9.7.2.2	Trimming outboard engines	9-31
9.7.2.3	Turning	9-32
9.7.3	Docking a vessel	9-34
9.7.3.1	Docking – general technique	9-34
9.7.3.2	Docking – strong winds or currents technique	9-35
9.7.4	Beaching a boat	9-37
9.7.5	Anchoring a boat	9-37

9.8	Advanced boat handling techniques	9-38
9.8.1	Manoeuvring alongside another vessel (pacing)	9-38
9.8.2	Determine approach	9-38
9.8.2.1	Course and speed	9-38
9.8.2.2	Approach from leeward and astern	9-39
9.8.2.3	Lines and fenders	9-39
9.8.3	Going alongside	9-39
9.8.3.1	Begin to close	9-39
9.8.3.2	Use a sea painter	9-40
9.8.3.3	Make and hold contact	9-41
9.8.3.4	Conduct the mission	9-41
9.8.3.5	Clearing	9-41
9.8.4	Close quarter situations	9-41
9.8.5	Using winds and currents to advantage	9-41
9.8.6	Station keeping	9-42
9.8.6.1	Winds and current	9-42
9.8.6.2	Waves	9-43
9.8.7	Backing	9-43
9.8.8	Shallow water manoeuvring techniques	9-44
9.9	Heavy weather boat handling	9-45
9.9.1	Heavy seas	9-46
9.9.1.1	Rolling	9-46
9.9.1.2	Pitching	9-46
9.9.1.3	Yawing	9-46
9.9.1.4	Running in following seas	9-47
9.9.2	Operating a vessel in excessive wind	9-47
9.9.2.1	Counteracting the effects of the wind	9-48
9.9.3	Heavy weather piloting	9-48
9.9.3.1	Preparation	9-48
9.9.3.2	Chart preparation	9-49
9.9.3.3	Chart labeling	9-50
9.9.3.4	Radar Ranges	9-50
9.9.3.5	Chart Stowage	9-50

9 BOAT HANDLING

9.1 GENERAL

Good boat handling is a combination of a thorough knowledge of the various forces involved and a working knowledge of the application of those forces in a given situation. Boat handling is a complex skill which requires extensive knowledge of the boat being handled and practice in applying that knowledge.

Experienced operators are familiar with the characteristics of their boats. They know the limitations of their boats in varying weather and sea conditions. They are also aware of the risks and dangers involved when they get underway in rough weather. But they sail with confidence in their ability to handle their boats against whatever the sea may offer. They know how to make their boats perform in response to changing sea conditions. Finally, they realize that the safety of their crews and the safety of those in distress depend largely upon the operator's boat handling skills and knowledge of sea conditions.

There is no substitute for the knowledge gained through actual experience. However, professional reading and study serve to provide both background and the necessary boat handling theory. The art of boat handling may be defined as the application of knowledge and skill acquired by study, observation and experience. Remember, not all boats handle the same way. Nothing can replace first-hand experience with a particular boat.

9.2 THE ART OF BOAT HANDLING

One of the best ways to judge the competence of a boat handler is to observe the manner in which the boat is controlled alongside a dock or float or in any situation where precise movements are required. One boat may be observed to complete a manoeuvre accompanied by considerable shouting, loud engine noises, and turbulent propeller wash. A second boat may perform the same manoeuvre quietly with no accompanying fanfare. Both boats have completed the same manoeuvre, but what a difference. The difference is technique or "boat handling." The boat handler who does the job with seemingly little effort – no wasted motion or action – is a skilled operator. The other seems to always be in a state of potential loss of control of the boat. Each manoeuvre seems to be performed to counteract the error of the previous one. If the engines were to fail, such an operator could get into trouble.

Boat handling requires an understanding of many variables and of complex problems. Though boat-handling skills can only be developed through hands-on experience, the information in this chapter provides background on the forces that affect basic boat handling techniques.

Though good operators are familiar with the characteristics of their boat and its operation, the best operators are knowledgeable in the operation of all types of craft, including sailboats and personal watercraft. They know how varying weather and sea conditions affect the operation of their vessel, but are also keenly aware of the limitations that the weather

and sea impose on other vessels. They have a thorough knowledge of navigation, piloting and the characteristics of their operating area. Above all, the best operators understand how to mesh the capabilities of their vessel with weather and sea conditions to conduct the safest possible boat operations.

9.3 ENVIRONMENTAL FORCES ACTING ON A BOAT

Different forces act on a vessel's hull, causing it to move in a particular direction or to change direction. These forces include environmental forces, propulsion and steering.

Environmental forces that effect the horizontal motion of a vessel are wind, seas and current. Remember that the operator has no control over them. Take the time to observe how the wind, seas and current, alone and together, affect your vessel. Determine how these forces cause your vessel to drift, and at what speed and angle. Operators must use environmental forces to their advantage, and use propulsion and steering to overcome environmental forces. Usually, a good mix of using and overcoming environmental forces results in smooth, safe boat handling.

9.3.1 Winds

The wind acts on the hull topsides, superstructure, and in smaller boats, on the crew. The amount of surface upon which the wind acts is called sail area. The vessel will make leeway (drift downward) at a speed proportional to the wind velocity and the amount of sail area. The "aspect" or angle the vessel takes due to the wind will depend on where the sail area is centred compared to the underwater hull's centre of lateral resistance. A vessel with a high cabin near the bow and low freeboard aft would tend to ride stern to the wind. If a vessel's draft were shallower forward than aft, the wind would affect the bow more than the stern. A sudden gust of wind from abeam while a vessel like this is being secured might quickly set the bow down on a pier.

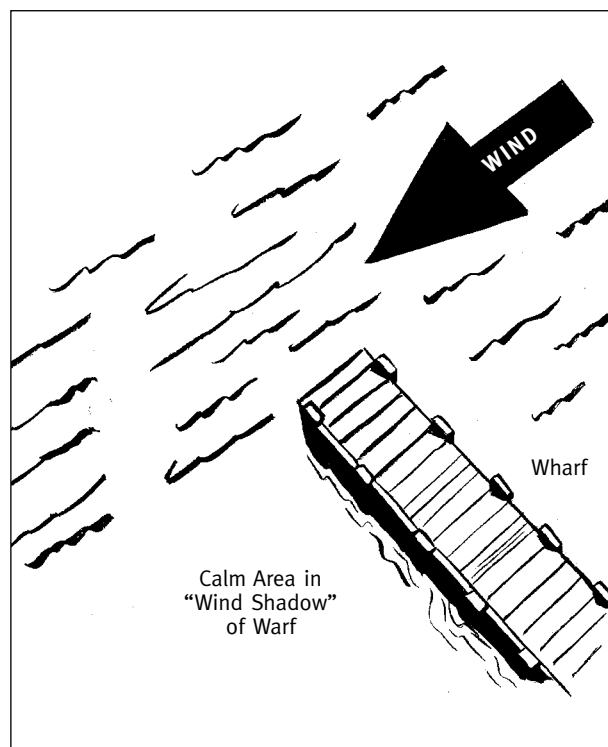

Figure 9.1: The wind shadow area of a wharf

Knowledge of how the wind affects a vessel is very important in all close quarters situations, such as docking, recovery of an object in the water, or manoeuvring close to another vessel. During manoeuvring from the downwind or leeward side of a vessel or pier, look for any wind shadow that the vessel or pier makes by blocking the wind. Make allowance for the change in wind by planning manoeuvres with the wind shadow in mind.

9.3.2 Seas

Seas are a product of wind acting on the surface of the water. Seas affect boat handling in various ways, depending on their height and direction and the particular vessel's characteristics. Vessels that readily react to wave motion, particularly pitching, will often expose part of the underwater hull to the wind. In situations such as this, the bow or stern may tend to "fall off" the wind when cresting a wave, as less underwater hull is available to prevent this downwind movement.

Relatively large seas create a temporary wind shadow for smaller vessels. In the trough between two crests, the wind may be substantially less forceful than wind at the wave crest. Very small vessels may need to make corrective manoeuvres in the trough before approaching the next crest.

9.3.3 Current

Current will act on a vessel's underwater hull. Though wind will cause a vessel to make leeway through the water, current will cause drift over the ground. A one-knot current may affect a vessel to the same degree as thirty knots of wind. Strong currents will easily move a vessel upwind.

Learn to look for the signs of current flow so that you are prepared when currents affect the vessel. Be particularly cautious of instances where current shear is present. As with wind, a large, stationary object like a breakwater or jetty will cause major changes in the amount and direction of current. Note the amount of current around floating piers or those with open pile supports. Use caution when manoeuvring in close quarters to buoys and anchored vessels. Observe the effect of current by looking for current wake or flow patterns around buoys or piers. Watch how currents affect other vessels.

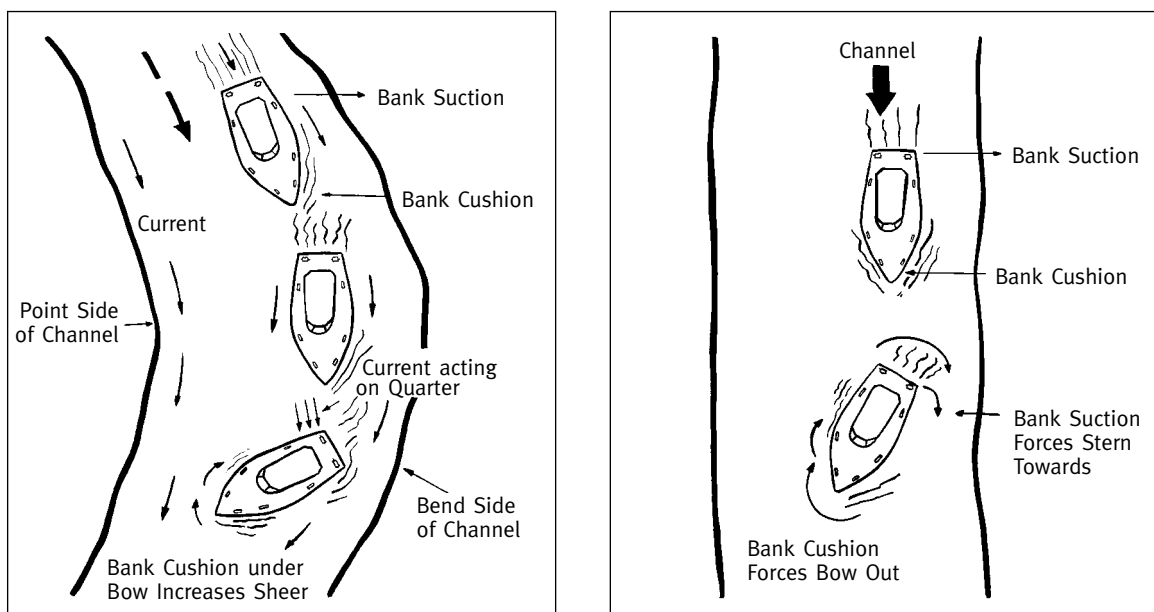

Figure 9.2a: The effect of current flowing near various structures or features of the landscape

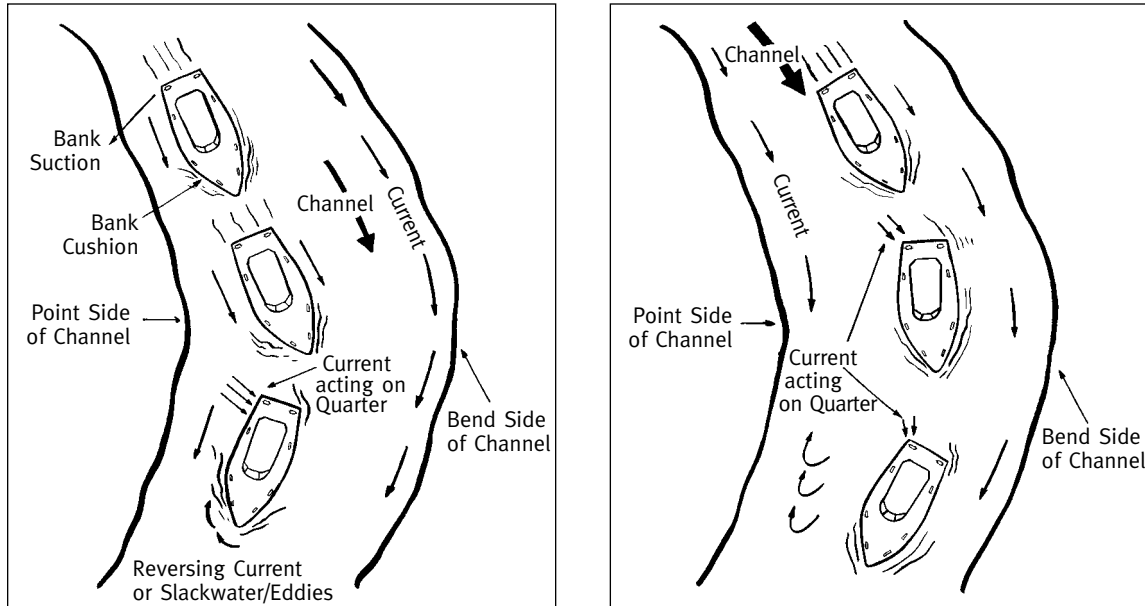

Figure 9.2b: *The effect of current flowing near various structures or features of the landscape*

9.3.4 Combined environmental forces

Environmental conditions can range from perfectly calm and absolutely no current to howling gales at spring tides. Chances are that even if you do not operate at either extreme, some degree of environmental forces will be at work.

Know how your vessel responds to combinations of wind and current and determine which one of the two has the greatest effect on your vessel. It may be that up to a certain wind speed, current has more control over a given vessel, but above that wind speed, the boat sails like a kite. Know what will happen if you encounter a sudden gust of wind; will your boat immediately veer, or will it take a sustained wind to start it turning?

When current goes against the wind, the wave patterns will be steeper and closer together. Be particularly cautious when current or wind is funneled against wind, or the reverse. Tide rips, breaking bars, or surf conditions frequently occur in these types of areas and may present a challenge to even the most proficient operator.

9.4 PROPULSION AND STEERING

Before learning how to overcome the forces created by propulsion and steering, you must learn how they act on a vessel.

This discussion on propulsion makes the following assumptions:

- If a vessel has a single shaft motor or drive unit, the latter is mounted on the vessel's centre line;
- When applying thrust to go forward, the propeller turns clockwise (when viewed from astern), and turns counterclockwise (viewed from astern) when making thrust to go astern;
- If twin propulsion is used, the propeller to starboard operates as a right-hand propeller (clockwise) while the port hand propeller operates as a left-hand propeller (counterclockwise);
- Be aware that some propeller driven units rotate in only one direction and changing the propeller blade angle of attack will control ahead and astern thrust (controllable pitch propellers).

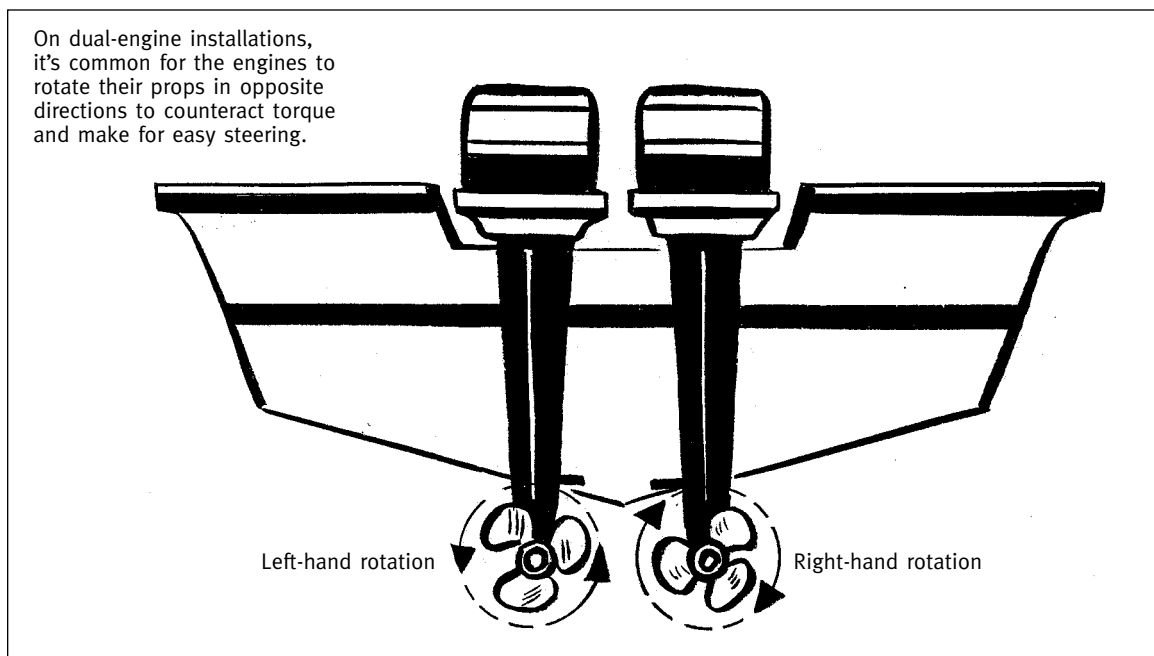

Figure 9.3: Direction of a propeller's rotation during motion ahead

The key to powered vessel movement is the effective transfer of energy from the source of the power to the water, through a mechanism that turns the engine's power into thrust. This thrust moves the boat. There must also be an element of direction control, both fore and aft, and from side to side.

Propulsion and steering are considered together here for two reasons. Applying thrust has no use if you cannot control the vessel's direction, and often the device providing the propulsion is also providing the steering. There are three common methods for transferring power and providing directional control:

- a rotating shaft and propeller with separate rudder;
- a movable (steerable) combination such as an outboard motor or stern drive; or,
- an engine-driven pump mechanism with directional control called a waterjet.

All three arrangements have their advantages and disadvantages from the standpoints of mechanical efficiency, ease of maintenance, and vessel control. Using one type of propulsion instead of another is often a matter of vessel design and use parameters, operating area limitations, lifecycle cost and frequently, personal preference. There is no single "best choice" for all applications. Regardless of which type you use, become familiar with how each operates and how the differences in operation affect vessel movement.

9.4.1 Shaft, propeller and rudder

In small craft installations, the propeller shaft usually penetrates the bottom of the hull at an angle to the vessel's designed waterline and true horizontal. The practical reason for this is that the engine or marine gear must be inside the hull while the diameter of the propeller must be outside and beneath the hull. There must also be a space between the propeller blade arc of rotation and the bottom of the hull. For single propeller vessels, the shaft is generally aligned to the centre line of the vessel. However, in some installations, a slight offset is used to compensate for shaft torque. To finish the installation, the rudder is usually mounted directly astern of the propeller.

For twin propeller vessels, this manual will limit itself to the case where both shafts are parallel to the vessel's centre line. Rudders are mounted astern of the propellers, and the rudders turn vertically on rudderposts.

9.4.1.1 Propeller action

When rotating to move in a forward direction, a propeller draws its supply of water from every direction forward of and around the blades. Each blade's shape and pitch develop a low-pressure area on the forward face of the blade and a high-pressure area on the after face of the blades, forcing the water to stream towards the stern. This thrust or dynamic pressure along the propeller's rotation axis is transmitted through the shaft, moving the boat ahead as the propeller tries to move into the area of lower pressure.

9.4.1.2 Propeller current

Regardless of whether the propeller is turning to go ahead or astern, the water flow pattern into the propeller's arc of rotation is called suction propeller current, and the thrust flow pattern out of the propeller is called discharge propeller current. The discharge propeller current will always be stronger and more concentrated than the suction propeller current.

Figure 9.4:
Propeller current

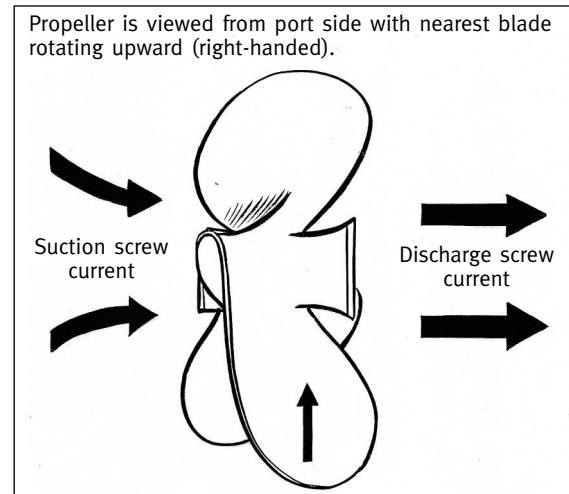

9.4.1.3 Side force

In addition to the thrust along the shaft axis, another effect of propeller rotation is side force. Explanations for side force include:

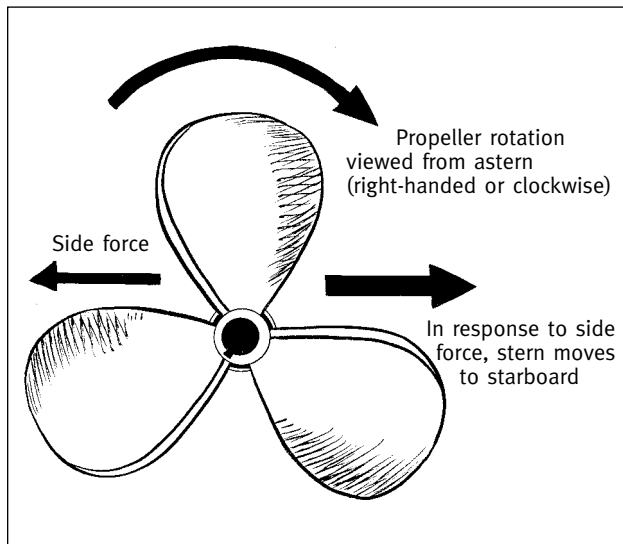

• how the propeller reacts to interference from the vessel hull as the hull drags a layer of water along with it (the propeller encounters boundary layer "friction wake");

• how the discharge propeller current acts on a rudder;

• the propeller blade at the top of the arc transforms some energy to the water surface (propeller wash) or to the hull (noise) and that the blade at the top of the arc either draws in air or encounters aerated water.

Figure 9.5: The concept of side force

Due to the angle of the propeller shaft, the effective pitch angle is different for ascending and descending propeller blades, resulting in an unequal blade thrust. (The descending blade has a higher effective pitch angle and causes more thrust.) This net effect is sometimes referred to as sideways blade pressure.

IMPORTANT FACTS:

- For a right-hand propeller turning ahead, the stern will tend to move to starboard, and for a right-hand propeller backing, the stern will tend to move to port;
- For a left-hand propeller (normally the port shaft in a twin propeller vessel), the action is opposite.

An easy way to remember how side force will push the stern is to think of the propeller as a wheel on the ground. As the wheel rolls clockwise, it moves to the right. As a propeller turns clockwise when viewed from astern, the stern moves to starboard.

9.4.1.4 Cavitation

Cavitation usually occurs when the propeller rotates at very high speed and a partial vacuum forms air bubbles at the tips of the propeller blades. Cavitation can also occur if you are trying to get a stopped propeller to spin at maximum speed, rapidly going from ahead to astern, or operating in aerated water where bubbles are dragged into the propeller flow.

Cavitation occurs more readily during attempts to back, as the suction propeller current draws water from behind the transom, and air at the waterline mixes with water and is drawn into the propeller. Cavitation frequently occurs during backing with outboard motors. In this case, through-hub exhaust gas bubbles are also drawn forward into the propeller blade arc.

Note: A small degree of cavitation is normal. This manual will use the term to cover the situation where effective thrust is lost and the propeller just spins and makes bubbles. Cavitation can diminish propeller efficiency to this point. Once cavitation occurs, the easiest way to regain thrust is to reduce propeller RPMs and, as the bubbles subside, gradually increase RPMs. Propeller cavitation can occur on vessels of all sizes.

9.4.1.5 Rudder action

If a vessel is moving through the water (even without propulsion), the rudder is normally used to change the vessel's heading. As a hull moves forward and the rudder is held steady amidships, pressure on either side of the rudder is relatively equal and the vessel will usually keep a straight track. When the rudder is turned to port or starboard, pressure decreases on one side of the rudder and increases on the other. This force causes the vessel's stern to move to one side or the other. As noted above, because a vessel rotates about its pivot point, as the stern moves in one direction, the bow moves in the other.

The speed of the water flowing past the rudder greatly enhances the rudder's force. The thrust of propeller discharge current from a propeller during motion ahead increases the water flow speed past the rudder. Also, if you turn the rudder to one side, it directs about one-half of the propeller thrust to that side, adding a major component of force to move the stern.

When you are operating astern, the rudder is in the propeller suction current. The rudder cannot direct any propeller thrust, and since the propeller suction current is neither as strong nor as concentrated as the propeller discharge current, water flow past the rudder does not increase as much. The combined effects of propeller current and rudder force during operation astern are not nearly as effective as during operation ahead.

As rudder force is determined by water flow along it, a rudder loses some of its effectiveness if the propeller cavitates and aerated water flows along the rudder.

9.4.2 Outboard motors and stern drives

Outboard motors and stern drives will be considered together, as both include a pivoting gear case and propeller drive unit (called a lower unit on an outboard). The difference between these drive arrangements and the shaft/propeller/rudder arrangement is that the propeller currents and thrust from an outboard or stern drive can be developed at an angle to the vessel centre line. Also, the point where thrust and steering are developed is usually aft of the vessel hull.

The lower unit contains drive gears, a spline connection, and on many set-ups, through-the-propeller hub exhaust. Many lower unit gear housings are over six inches in diameter. When the stern drive is powered by an inboard engine attached through the transom to the outdrive, it is commonly referred to as an inboard/outdrive or I/O. The outboard “powerhead” (engine) is mounted directly above the lower unit. Both outboards and stern drives can usually direct thrust at up to 35° to 40° off the vessel centreline. Also, both types generally allow the operator some amount of trim control. Trim control adjusts the propeller axis angle with the horizontal or surface of the water.

The major difference in operation between the I/O and outboard is that the outboard motor, operating with a vertical crankshaft and driveshaft, develops a certain degree of rotational torque that could cause some degree of “pull” in the steering, usually during

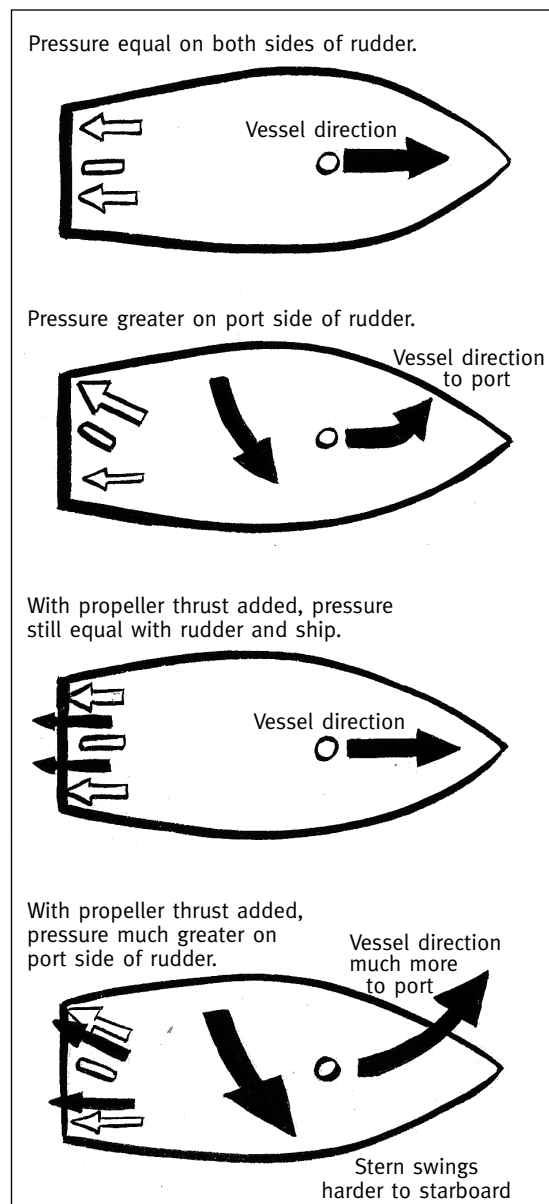

Figure 9.6: Effect of rudder action on vessel direction

acceleration or in a sharp turn to starboard. If caught unaware, the operator could have difficulty stopping the turning action. The easiest way to overcome this torque-lock is to immediately reduce RPMs before trying to counter-steer.

9.4.2.1 Thrust and direction control

Outboards and stern drives have a small steering vane or skeg below the propeller. The housing above the gearcase (below the waterline) is generally foil-shaped. Though these features help directional control, particularly at speed, the larger amount of steering force from an outboard or stern drive is based upon the ability to direct the propeller discharge current thrust at an angle to the vessel's centre line. This directional thrust provides extremely effective directional control during powering ahead. When there are no propeller RPMs, the lower unit and skeg are not as effective as a rudder in providing directional control.

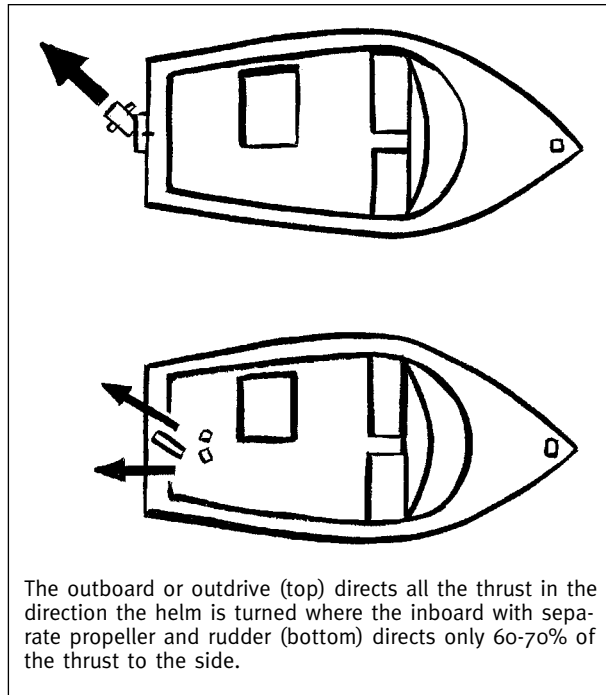
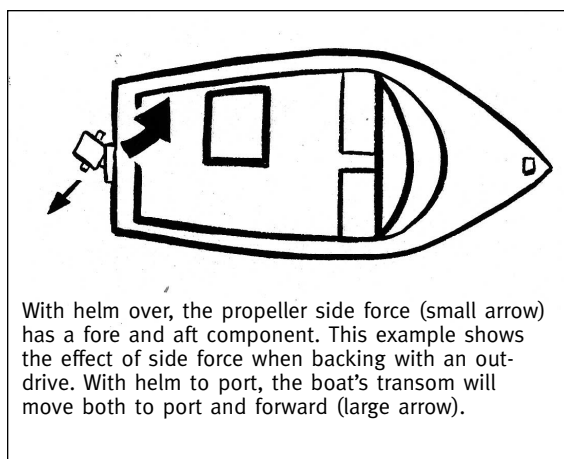

Figure 9.7: Lower unit/outdrive directed thrust

9.4.2.2 Propeller side force

When backing, you can direct outboard/outdrive thrust to move the stern to port or starboard. During backing with the unit hard over to port, propeller side force introduces an element of forward motion, but can be countered through less helm. In the case of backing



to starboard, the side force tends to cause an element of astern motion, and also tries to offset the initial starboard movement. Many lower units are fitted with a small vertical vane, slightly offset from the centreline, directly above and astern of the propeller. This vane acts to counter side force, particularly at higher speeds.

Figure 9.8: Lower unit/outdrive side force

9.4.2.3 Vertical thrust

Outboards and stern drives usually allow a level of vertical thrust control. Trim controls the angle of attack between the propeller's axis of rotation and both the vessel waterline and the surface of the water. Vertical thrust control, especially applied aft of the transom, changes the attitude the vessel will take in the water. Use small amounts of trim to offset extreme loading conditions or to adjust how the vessel operates in wave conditions.

In addition to trim, a vertical component of thrust develops in another situation. If a vessel with a certain type of hull is forced into an extremely tight turn with power applied, thrust is directed sideways while the vessel heels, actually trying to force the transom up out of the water and causing the turn to tighten even more.

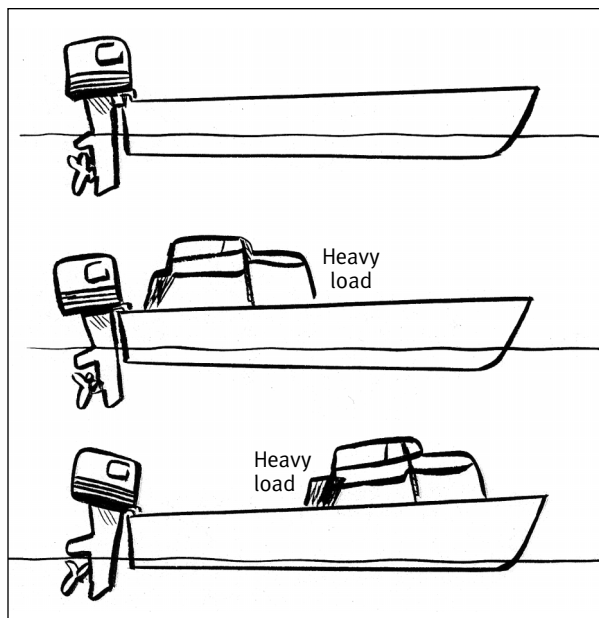

Figure 9.9: Using trim to offset loading conditions

WARNING

In boats equipped with high horsepower outboards, such as fast rescue craft, use of full power in tight turns can cause loss of control or ejection of crew or operator. Engine kill switches must be worn by the operator at all times.

9.4.2.4 Cavitation

As noted earlier, cavitation frequently occurs during backing with outboard motors. As through-hub exhaust bubbles are drawn forward into the propeller blade arc, the aerated water increases the possibility of cavitation. Outboards and stern drives are fitted with an anticavitation plate above the propeller, but it is important to always take care to limit cavitation, particularly when using large amounts of throttle to back or manoeuver.

9.4.3 Waterjets

A waterjet is an engine-driven impeller mounted in a housing. The impeller draws water in and forces it out through a nozzle. The suction side of the waterjet is forward of the nozzle, usually mounted at the deepest draft near the after section of the hull. The discharge nozzle is mounted low in the hull, exiting through the transom. The cross-sectional area of the inlet is much larger than that of the nozzle. The volume of water entering the inlet is the same as that being discharged through the nozzle, so the water flow is much stronger at the nozzle than at the intake. This pump-drive system is strictly a direct-thrust drive arrangement. A waterjet normally has no appendages, nor does it extend below the bottom of the vessel hull, allowing for operation in very shallow water.

9.4.3.1 Thrust and direction control

Vessel control is through the nozzle-directed thrust. To attain forward motion, the thrust exits directly astern. For turning, the nozzle pivots (like a stern drive) to provide a transverse thrust component that moves the stern. For astern motion, a bucket-like deflector drops down behind the nozzle and directs the thrust forward. Some waterjet applications include trim control as with a stern drive or outboard. With this, thrust can be directed slightly upward or downward to offset vessel loading or to improve ride.

If a waterjet craft is proceeding at high speed, and the power is brought down quickly to neutral and the helm put over, no turning action will occur. Of the three drive arrangements discussed, the waterjet alone has no directional control when there is no power.

9.4.3.2 No side force

Since the waterjet impeller is fully enclosed in the pump-drive housing, no propeller side force is generated. The only way to move the stern to port or starboard is by using the directed thrust.

9.4.3.3 Cavitation

Waterjet impeller blades revolve at extremely high speed. A much higher degree of cavitation normally occurs than associated with external propellers, without a loss of effective thrust. In fact, a telltale indicator of waterjet propulsion is a pronounced aerated-water discharge frequently seen as a “rooster tail” astern of such craft.

As the impeller rotation does not change with thrust direction, frequent shifting from ahead to astern does not induce cavitation. However, as the thrust to make astern motion reaches the waterjet intake, the aerated water is drawn into the jet, causing some reduction of effective thrust. As with all types of propulsion, slowing the impeller until the vessel is clear of the aerated water reduces cavitation effects.

Given all their limitations, jet drives are not recommended for SAR applications.

9.5 BOAT HANDLING CHARACTERISTICS

9.5.1 Inherent handling characteristics

Get the feel of your boat and become virtually one with it so that it becomes an extension of yourself. Be attentive to detail about the characteristics of your boat, such as:

- the distance your boat will maintain headway through the water after you clutch out to neutral (shift gear to neutral) from the ahead position. Planing hulls will settle and come to rest faster than displacement hulls.
- the feel of clutch shift: forward to neutral, neutral to reverse, the distance the handle must be moved before it engages and disengages. Does the shift have a noticeable “notch”?
- how quickly headway or sternway can be checked by reversing the direction of the propeller.
- at what speed will your boat (single propeller) back into the wind instead of to port (or starboard according to propeller rotation), if it will at all?
- how will your boat lie to the wind, current or sea, if allowed to drift?
- if the boat has twin propellers, at what wind and current speed will it be unable to pivot by opposing the propellers?
- the effectiveness of your propeller(s) in reverse gear. Propellers are designed to be most effective during forward motion.

9.5.2 Single propeller characteristics

A single-propeller boat presents the greatest challenge to an operator’s boat handling abilities. Single-propeller boats are manoeuvred through the application of the combined forces of both rudder and propeller.

9.5.2.1 Dead in the water

If a powerboat is dead in the water, moving the rudder from side to side will have no effect on the direction or motion of the boat. Powerboats depend upon a discharge current of water directed astern to provide forward propulsion or a discharge current of water directed forward to provide astern propulsion. Steering is accomplished by deflecting the discharge current by means of a rudder.

9.5.2.2 Right-hand propeller – ahead

If the propeller is turned ahead, there are two components of the resulting thrust from the propeller’s rotation that have observable results. The discharge current of the rotating propeller tries to move the boat forward, but the side force will cause the stern to go sideways.

Again, to aid in visualizing this, imagine looking at a propeller from astern. Depending on which way the propeller is turning, unequal side blade thrust will produce a side force as though the propeller were walking along the bottom.

The initial effect of the right-hand turning propeller (side force) of a single-propeller boat is to force the stern to starboard. There are exceptions, but this is the general rule. The sideways propeller forces grow less important as the boat begins to move forward through

the water and speed increases. Some boats will always have a side force component present at the stern and require a standard wheel correction to maintain a straight course.

9.5.2.3 Right hand propeller – astern

Going astern on a right-hand, single propeller boat tends to swing the stern of the boat to port. This is caused by side blade thrust and both the interaction of the propeller with the hull shape and clearance between the tips of the propeller blades and hull. There are single-propeller boats that will back to starboard (although this is most unusual), and a few which will constantly do the unexpected (as a result of external unnoticed factors at the time). In any case, since there are many factors involved, the prudent operator learns the operating characteristics of each boat. In backing a single-propeller boat remember that most right-handed single-propeller boats will usually back to port or back into the wind. However, winds and current may counteract the boat's usual behaviour.

9.5.2.4 Rudder position – backing

If the circumstances permit, place the rudder amidships initially when backing, or the “kick” on the rudder caused by a hard back-down may damage the steering system. As sternway builds, the rudder begins to have a greater effect on manoeuvring and the boat may be backed like a car. When backing in the wind, always ensure that the rudder is placed midships before engaging the engines.

9.5.3 Twin propeller characteristics

Twin propeller boats in which I/O units with both propellers are right-handed behave like single-propeller boats with right-handed propellers. However, on most twin-propeller inboards, the starboard propeller is right-handed, while the port propeller is left-handed (or counter-rotating). In other words, viewed from the stern, the starboard propeller turns clockwise while the port propeller turns counter-clockwise. On many installations, (but not all), a rudder is located immediately behind each propeller, and therefore, the same basic principles that apply to a single-propeller boat, with regard to propeller action may also be applied to each propeller of a twin-propeller boat.

The important difference is that, with counter-rotating propellers, one propeller cancels out the side force effects of the other when both are turning at the same RPMs, either ahead or astern. This cancelling-out can be used to advantage when manoeuvring in restricted areas, because the effects of the two-propeller thrust can be controlled by changing the thrust of either propeller.

9.5.3.1 Port propeller stopped

With the port propeller stopped, rudder amidships, and the starboard propeller ahead, the result will be a wide turn to port while making headway.

With the port propeller stopped, rudder amidships, and the starboard propeller astern, the result will be a wide turn to port while making sternway.

9.5.3.2 Starboard propeller stopped

With the starboard propeller stopped, rudder amidships, and the port propeller ahead, the result will be a wide turn to starboard during headway.

With the starboard propeller stopped, rudder amidships, and the port propeller astern, the result will be a wide turn to starboard during sternway.

9.5.3.3 Twin propeller pivot turn

With no way on, a twin propeller boat can usually be made to pivot slightly more than her own length by merely opposing the propellers – going ahead on one and astern on the other. When the propellers are opposed, a single rudder may be placed amidships, because it will have little effect. In twin-propeller vessels with twin rudders, the rudders should be placed midships before opposing the propellers, because the discharge current of the forward-driving propeller will be deflected by a turned rudder. This deflected current will be much stronger than the deflection caused to the opposing propeller's suction current. The result will be a poor pivoting performance.

A propeller turning ahead provides more thrust than the same-sized propeller turning astern at the same RPMs. This is readily apparent when a twin propeller boat is pivoted. If both propellers are opposed at the same RPMs, slight headway will result, with a turning towards the side on which the propeller is going astern. Consequently, if a perfect pivot is desired, the propeller turning astern must be turned a little faster than the one going ahead.

WARNING

This manoeuver should NOT be performed at high RPMs. Remember that the pivot point is located midway between the two propellers so the leverage action is extremely weak. If that manoeuver cannot be performed effectively at low RPM, you should consider using another manoeuver.

9.5.3.4 Twin propeller steering

In the event of a steering gear casualty, a twin-propeller boat may be steered by the independent use of each propeller. To direct the heading to port, simply go faster on the starboard propeller than on the port propeller.

To direct the heading to starboard, simply go faster on the port propeller than the starboard propeller.

At slower speeds, bringing one propeller to a stop or astern will result in the boat's going either to port or to starboard, depending on which propeller was stopped or backed.

9.5.4 Outboard and I/O characteristics

Boat handling with outboard motors or I/O drives is quite different than for inboard powered craft. Boats propelled by outboard motors or by I/O drives have essentially the same operating characteristics. For the balance of this section, the two types will be considered together, with the technical terminology used interchangeably.

9.5.4.1 Major differences

Boat handling with outboard drives is easier than with inboard propulsion:

- Since the lower unit (acting as a rudder) and the propeller are one, the effect in steering ahead produces more turning torque and thus greater manoeuvrability;
- During motion astern, the net effect of the combined lower unit and the propeller is, again, more manoeuvrability;
- Without power, the outboard or I/O lower unit (which is the rudder) has less manoeuvrability than an inboard powered boat with a relatively larger rudder(s), and about the same manoeuvrability as a fast inboard with small rudder area;
- Smaller outboards use a steering handle or tiller, similar to that used in small sailboats. Moving the tiller to one side moves the stern in the same direction, and thus the bow in the opposite direction;
- There is little or no unequal side blade thrust effect from the propeller, compared with inboard installations. This is because the propeller pushes nearly horizontally. What little effect there might be on larger units is due to the engine being trimmed up or down so that the propeller is not pushing parallel to the water surface. The effect can generally be offset with an adjusting trim tab;
- During docking, the same principles apply as with inboard powered vessels. The exception is that the greater manoeuvrability allows for better control in getting away from a dock. Also, during approach to a dock, the lower unit/propeller can be backed towards the dock, bringing the stern in more readily from an angled approach;
- During departure from a dock in extremely close quarters, the stern can be steered away from the dock, allowing the boat to get well away from the dock before getting underway;
- Still greater manoeuvrability may be had with twin outboards or I/O units by driving one unit ahead and the other astern to produce a greater turning torque;
- Outboard and I/O drives are frequently equipped with a trim device so that the direction of thrust of the lower unit/propeller may be adjusted to help the planing characteristics of the vessel. This feature allows for a choice of handling characteristics based on rough or smooth water handling requirements.

9.6 TYPES OF HULLS

9.6.1 Displacement hulls

The term “displacement vessel” refers to the fact that a boat of this sort displaces a weight of water equal to its own weight. Underway, a displacement vessel constantly displaces or shoves aside the water in its path, while water from either side closes in behind it. At any given moment, however, the weight of the displaced water continues to equal the weight of the vessel.

9.6.1.1 Wave drag and theoretical hull speed

The bow of a moving boat tends to push water both sideways and ahead. In the process, it creates a localized zone of higher pressure in which the water bulges above the average level of the surrounding surface. The result is a bow wave that streams obliquely away from the vessel’s stem. Amidships, water that has already been elbowed aside is moving laterally and downward, and the water level drops below the surrounding average. Near the stern, another bulge forms as the surrounding water surges inward and upward to fill the space that the hull is vacating. The net result is the familiar v-shape wake or wave array that constantly streams away from a displacement vessel – at least, a displacement vessel that is moving smartly. The existence of this self-induced wave system often lowers the average water level in the immediate vicinity of the vessel. When this occurs, the hull will settle a little deeper to maintain the essential equilibrium between its weight and the amount of water it displaces.

Complicated though this may seem, it is actually something of an oversimplification, as anyone who has studied wake patterns will recognize. However, it is accurate to sum up the situation by saying that a boat’s movement sets up a pattern of high and low pressure regions in the water nearby. In high-pressure areas, the water rises above the average water level, while in low-pressure regions, it sinks below the average level. Waves propagate because water is “disinclined” to remain above or below the average level for any length of time (i.e., as you learned in grade school science, it seeks its own level). Instead, it flows laterally a little, so each high spot successively floods its neighboring lower spot. The progress of each wave is a chain reaction, analogous to the sequential collapse of a domino chain.

The speed of wave propagation at the water’s surface depends upon the length of the wave in question. With longer waves, each rise-and-fill cycle covers more ground, and the wave “strides along” more quickly. Waves seldom occur singly, so it is convenient to measure the

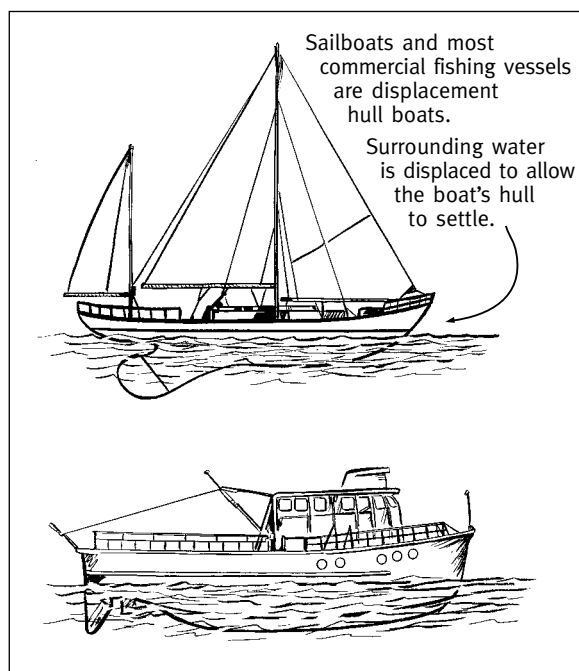

Figure 9.10: Displacement hulls

wavelength by measuring the distance from one crest to the next. Empirical measurement shows that wave speed (in knots) is 1.34 times the square root of the wavelength in feet ($S = 1.34\sqrt{WL}$).

Anyone who has watched storm surf breaking on a beach is well aware that waves transmit energy. Storm waves are created by wind energy, while a boat's wake is a manifestation of propulsive energy originating with either engine(s) or sails. A bigger wake represents more energy being dispersed, or in other words, more wave-making resistance.

You are now in a position to appreciate why displacement hulls experience restrictive upper speed limits. The speed of the wave system created by a moving hull is determined by the speed of the hull itself. In order to progress at that speed, the wave length of this entailed wave system automatically adjusts itself to maintain the mathematical relationship between speed and wave length that was described above ($S = 1.34\sqrt{WL}$). When the boat is moving slowly, the natural wavelength is shorter than the hull, the average water level in the vicinity of the boat stays "normal," and resistance remains in the moderate range. On the other hand, when the speed of the boat increases to the point that the natural wave length of the driven wave system exceeds the immersed length of the hull, the boat literally begins to drop into the trough between its own wave crests. As speed increases, the crest of the bow wave remains in the immediate vicinity of the bow (as it obviously must), but the crest of the quarter-wave moves progressively aft. At a speed equal to about 1.34 times the square root of the boat's waterline length ($S = 1.34\sqrt{WLL}$), the quarter-wave crest is positioned right at the stem. If the boat is propelled still faster, this crest slips behind the stem and the stem of the boat begins to settle into the trough. In effect the boat is now positioned on an upward slope, balanced on this moving hillside by the thrust of its propeller. If prop thrust is increased further, the quarter-wave slips a little further astern, the wave slope steepens, and vessel's trim angle increases even more. Instead of going appreciably faster, the vessel simply disperses more energy in the form of a larger wake. This formula ($S = 1.34\sqrt{WLL}$) is commonly regarded as the theoretical hull speed of displacement boats, partly because it relates directly to the propagation and velocity of waves, and partly because it provides an approximation of the upper practical speed limit for vessels of this type. By the time the speed-to-length ratio approaches 2.0, our displacement vessel can be considered to be in a transitional planing mode.

9.6.2 Semi-planing hulls

Semi-planing hulls (or semi-displacement, depending on your viewpoint) are designed to operate with reasonable efficiency in the transitional zone where the speed-to-length ratio lies between 1.34 and 2.5. Once the ratio exceeds 1.34 and the crest of the stem wave begins to fall behind, the fullness of the stem provides extra buoyancy. This reserve buoyancy aft prevents the trim angle from increasing excessively and retards the rate of drag build-up. At the same time, a fuller bow causes the bow wave to form a little further forward, thus slightly advancing the whole wave system forward.

Semi-planing hulls are compromises, but they can represent a good compromise for any owner who wants reasonable cruising economy, yet enough reserve speed potential to make an important rendezvous or outrun a storm.

At speed-to-length ratios of less than 0.9, the quarter wave of a typical displacement hull is situated along the flanks of the vessel, well forward of the stem. The length of the arrow indicates the wavelength of the “entrained” wave system (see Figure 9.12).

As the speed-to-length ratio rises to 1.4, the bow wave and quarter wave enlarge and separate, with the crest of the quarter wave moving aft to the vicinity of the transom.

At a speed-to-length ratio of 2.0, the crest of the quarter wave is behind the transom. Pronounced stern-down trim is caused by the large wave’s encompassing the entire aft half of the hull. As a result, the power plant must constantly push the vessel “uphill”.

A hull with a high prismatic coefficient has relatively full ends. At higher speed-to-length ratios, it generates less drag relative to displacement than a free-ended boat, mainly because its fuller quarters provide more buoyancy to counteract stern-squat. In addition, its “bluffer” bow causes the bow wave to form further forward, lengthening the induced wave system.

9.6.3 Planing hulls

Displacement vessels have been evolving for thousands of years, although power-driven ones have admittedly become possible only in the last couple of centuries. Planing boats, on the other hand, are barely older than the airplane, whose military role has guaranteed its ever-increasing sophistication. Today’s best planing boats, although dramatically superior to their forebears, will probably be significantly out-designed in the not-too-distant future. This section endeavours to explain the fundamentals of planing hull design and operation, as well as the significance of current innovations.

9.6.3.1 What is planing?

Just about everyone knows that planing implies sliding or skimming over the surface of the water. However, a full appreciation of a planing boat, requires a closer look.

Any true displacement vessel, including a planing hull at low speed, is sustained – buoyed up – by hydrostatic forces exactly equal to its own weight. This convenient situation arises because surrounding water can’t “tell the difference” between an actual boat

and the boat-shaped slug of water that occupied the same space before the boat came along. In either case, the surrounding water passes inward and upward with equal force. Therefore, when a boat is launched, it automatically settles into the water until the weight of the water it displaces exactly equals its own weight.

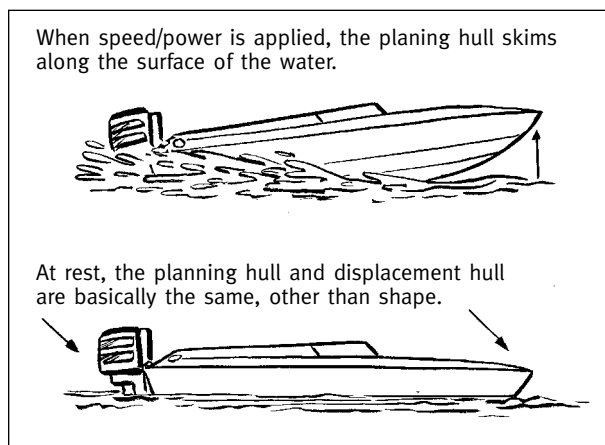

Figure 9.11: A planing hull

Many boats, particularly the planing designs, convert some of the energy of their forward motion into vertical lift by deflecting water downward. A flat stone skipped across a pond obtains lift in the same way, temporarily remaining above the water's surface despite the fact that stones are too dense to float. Unlike the skipped stone, which rebounds from the surface at high speed, a planing boat can never obtain enough dynamic lift from the water to lower its displacement all the way to zero, although fast ones come close. (Of course, with the addition of aerodynamic lift, light racing hydroplanes readily become airborne and, not infrequently, crash as a result.)

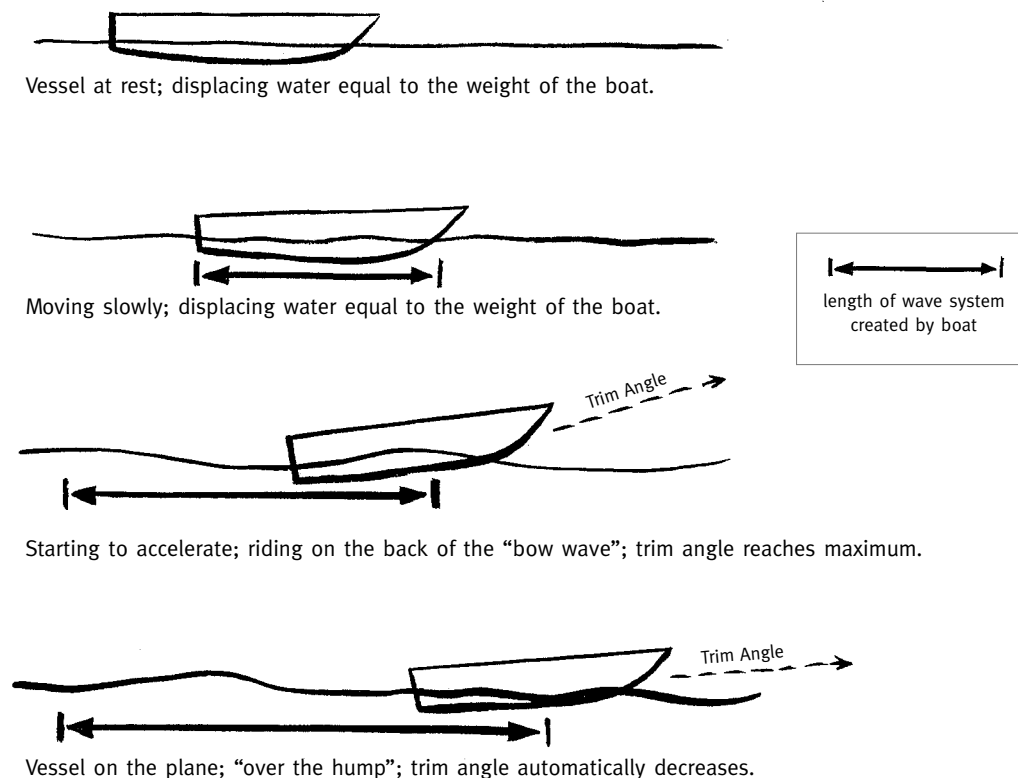

Figure 9.12: A planing hull taking up speed

Speed potential in a displacement vessel is harshly limited by the inherent speed of the wave system the vessel generates as it shoulders water aside. In simple terms, the displacement vessel lacks the power to climb appreciably up the back face of its own bow wave. On the other hand, a boat on a clean plane perches just behind the crest of the wave it creates by deflecting water downward, forward and outward. The water shoved down and aside by the passage of the hull, instead of closing in directly behind the boat and forming a distinctive stern or quarter wave, breaks cleanly away at the transom and chines. The faster the boat goes, the longer it takes this water to rebound in the boat's wake. Thus the "stern wave" of a planing hull, unlike the well-defined quarter-wave of a displacement hull, trails

a substantial distance behind the transom. The faster the planing boat goes, the further the stern wave lags behind.

9.6.3.2 Trim angle

The vast majority of runabouts, fishing boats, and planing cruisers are flat or V-bottom designs with no transverse steps or discontinuities in their running surfaces. When a boat of this type accelerates from a standstill, the trim angle first increases, peaking about the time that planing commences (i.e. the water begins to break cleanly away at the transom and chines), and progressively levels off as the speed continues to climb. This self-trimming feature is characteristic of all stepless planing hulls.

The drag associated with too large a trim angle (bow in the sky) can prevent a boat from climbing “over the hump” and onto a plane if the available power is marginal proportional to the load. As any experienced small boat operator knows, a boat struggling to get onto a plane can often be helped along by shifting weight toward the bow. On the other hand, the highest speeds for a given hull, load and power plant are generally attained when the boat's centre of gravity is quite far aft, despite the fact that this load distribution often makes it significantly harder to start planing in the first place.

To understand why planing boats react in these familiar ways, consider the two main sources of resistance in a planing boat. The first is simply the energy required to deflect water downward as it encounters the boat bottom. A steeper trim angle causes water to be deflected more abruptly, which not only creates larger lifting forces, but also absorbs more energy in the process. Roughly speaking, the work of generating dynamic lift matches the work of a loaded boat hauling up a friction's ramp whose slope equals the trim angle.

The second source of resistance is, of course, skin friction. Frictional drag is determined mainly by wetted area and secondarily by surface finish. Skin friction and trim angle drag are, to some extent, inversely related. For example, if trim angle is increased and speed held constant, wetted surface (and skin friction) will decrease somewhat. Minimizing total drag in a planing boat boils down to obtaining the optimal combination of trim angle and wetted surface to carry the chosen load at the desired speed. Obtaining this optimal combination is more a matter of initial hull design than movable weight positioning, trim tab adjustments or the like. Fortunately, the basic elements of sound hull design are by now well understood, thanks to the pioneering work of such naval architects as Lindsey Lord and Raymond Hunt.

9.6.3.3 The evolution of V-bottomed hulls

Planing boat design really began to progress in the 1930s when some designers and builders started to appreciate that wetted beam, not wetted length, largely determines the ability of a hull to lift and plane. The reason for this is simple.

The leading edge of the bottom – the part that first encounters new water – forces that water downward very abruptly, while the remainder of the bottom can only hurry along water that is moving downward already. Peak pressures, and hence peak lift, thus occur right at the leading edge of the hull. An increase in wetted beam creates a longer leading edge and, if trim angle and speed remain constant, causes an increase in lift. Conversely, a long, slender planing bottom will have a lot more wetted surface (and therefore higher resistance from skin friction) than a short, wide hull carrying equal weight at equal speed. On the other hand, if wetted length becomes too short, a tendency to pitch and slam will develop. This unpleasant behaviour, called porpoising, is particularly likely when the centre of gravity in a flat bottom boat is moved far aft in an effort to maintain an optimal trim angle and thus maximize speed. V-bottom boats have acquired their overwhelming popularity partly because their extra wetted length along the keel makes them highly resistant to porpoising. (Two other advantages of V-bottoms, their enhanced ability to negotiate rough water at high speed and to bank into turns, will be discussed a bit later.)

The term deadrise refers to the amount that each side of a V-bottom angles up from the horizontal. Deadrise varies from a normal low of about 1.5 m (5 ft.) for some hard chine runabouts to 8 m (27 ft.) for the most radical seagoing deep-V hulls. The chief drawback of a deadrise is that water is pushed outward as well as downward by the angled bottom. For a given speed and load, a V-bottom will create more drag and require more power than a flat bottom. In almost all cases, this trade-off is worthwhile. For comfortable or even tolerable rides in choppy water, very steep deadrise angles were quickly recognized as superior, although they greatly increased power requirements.

For optimal performance, the entire running surface of a planing hull (the wetted area during planing) should be perfectly flat longitudinally. In the case of a V-bottom, the wetted portions of the port and starboard panels, viewed individually, should be completely flat in both directions. The harm done by convexity in the running surface, particularly longitudinal convexity, can be demonstrated by dangling a spoon by its handle so that the bottom of the bowl contacts a stream of water from a faucet – the spoon will be pulled into the stream.

Concavity in a planing bottom (usually in the form of a droop near the trailing edge) does less damage than convexity, but is generally inferior to a flat, unwarped “delta” surface. Trim tabs provide such a hooked shape when extended. In boats whose centre of gravity is located far aft, they can sometimes improve performance a little, but at higher speeds, they usually flatten the trim angle excessively. The term monohedron is often applied to boats with flat, unwarped planing surfaces.

9.6.3.4 Heeling and stability

Good planing hulls, instead of leaning away from turns like displacement boats or automobiles, heel into them like motorcycles. The explanation for this valuable trait is rooted in the basic principles of planing. When a boat enters a turn, centrifugal force causes it to skid sideways somewhat. In the process of skidding, the boat is actually planing sideways to some extent as well as forward. As a result, the high lift leading edge area shifts toward the side of the bottom that is on the outside on the turn, raising it and causing the boat to heel.

V-bottom boats heel harder and more reliably in turns than flat bottom boats. As a V-bottom boat skids sideways, the outer side of the hull meets the water at a large trim angle and develops lots of lift, while the inner side contacts the water at a much smaller angle and may easily develop suction.

The tendency of planing boats to lean into a crosswind (instead of away from it like displacement vessels) is closely related into heeling into turns. When the wind blows the boat sideways, the downwind side of the hull becomes a leading edge to some extent and develops more lift than the upwind side.

Good planing boats are more stable at speed than they are at rest. When weight is shifted to one side of a displacement boat, the boat heels, moving the centre of buoyancy laterally until it is again in vertical alignment with the centre of gravity – this time with the boat heeling to some extent. However, when a boat is planing, the same weight shift will also alter the trim angle on one side of the bottom relative to the other, inducing an additional and comparatively large dynamic.

With many boats, weight forward helps to optimize the trim angle for low planing speeds. With weight aft, the trim angle will be too great, causing excessive drag and difficulty getting up onto a plane. On the other hand, for fast running, weight forward can reduce the trim angle excessively, leading to an increase in both wetted surface and total drag. Less total drag and hence greater speed is achieved with the weight aft.

A planing hull at rest or moving slowly displaces a weight of water equal to its own weight. As it picks up more speed, the hull climbs onto the back slope of the “bow wave,” and water flowing under the hull begins to break cleanly away at the transom. During the process of getting “over the hump” and onto a plane, the trim angle reaches a maximum. As the boat planes faster, the trim angle automatically decreases.

9.7 BASIC BOAT HANDLING TECHNIQUES

9.7.1 Leaving the dock

9.7.1.1 Prior to getting underway

Before getting underway, the prudent operator will ensure that the boat and crew are ready for sea. Each time, the boat should be checked for correct and complete stowage of boat gear and proper operation of equipment. This is easily accomplished if a checklist is used. Routine checking of boat plug, bilges, fuel level, oil level, as well as proper venting (bilge blower), and other items on the list should not be forgotten before the engine is started. All shore connections for electricity, water and communications should be disconnected before starting the engine.

9.7.1.2 Getting underway

With the engine warmed up and all gauges reflecting the proper readings, it is time to get underway. Check the immediate surroundings before casting off. All hazards and obstructions should be noted, and the direction and strength of the wind and current taken into consideration.

9.7.1.3 Leaving the dock

All fenders should be taken in and mooring lines stowed as soon as the mooring is cleared. The stern is the only part of the boat that can be steered. The stern moves sideways and must be watched. This is not to say that the bow does not need to be watched but, all too many operators, while concentrating on the bow, have slammed their boat's stern into an object while manoeuvring.

Mooring lines

Mooring lines may be used to assist in manoeuvring. The bow and stern lines are simple to deploy and are usually sufficient, provided that they are of adequate size and that fenders are used at strategic points along the hull to prevent chafing against the dock or float.

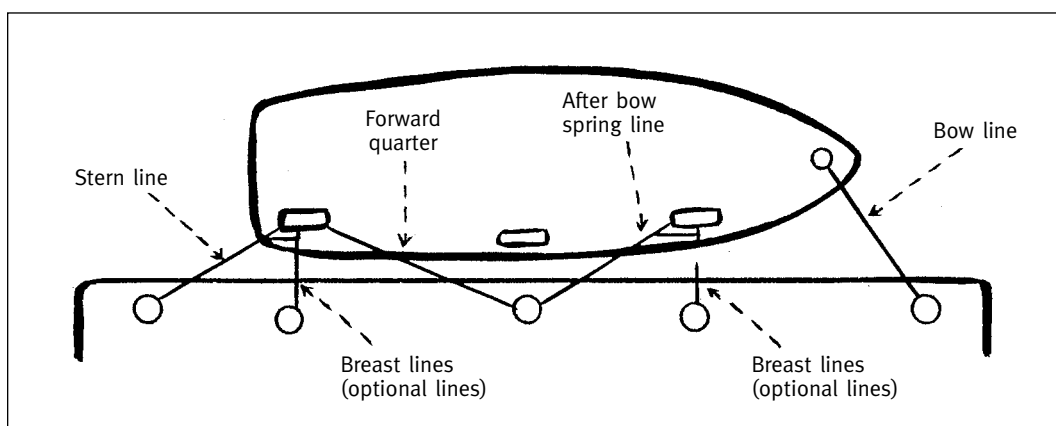

Figure 9.13: Mooring lines

Spring lines

Spring lines are used to prevent the fore-and-aft movement, or surge, of a boat alongside the dock. The after bow spring (or bow spring) leads aft from the bow to the dock. Going ahead on the boat's engines with the rudder turned full towards the dock and the after bow spring attached to the dock will cause the stern of the boat to move away from the dock – that is, the stern will “spring out.” With the rudder turned full away from the dock, the stern will be “sprung in” to the dock.

The forward-leading after spring, or stern spring, leads forward from the quarter to the dock. Backing the boat's engines with only the stern spring attached to the dock will cause the bow to move away from the dock (or “spring out”).

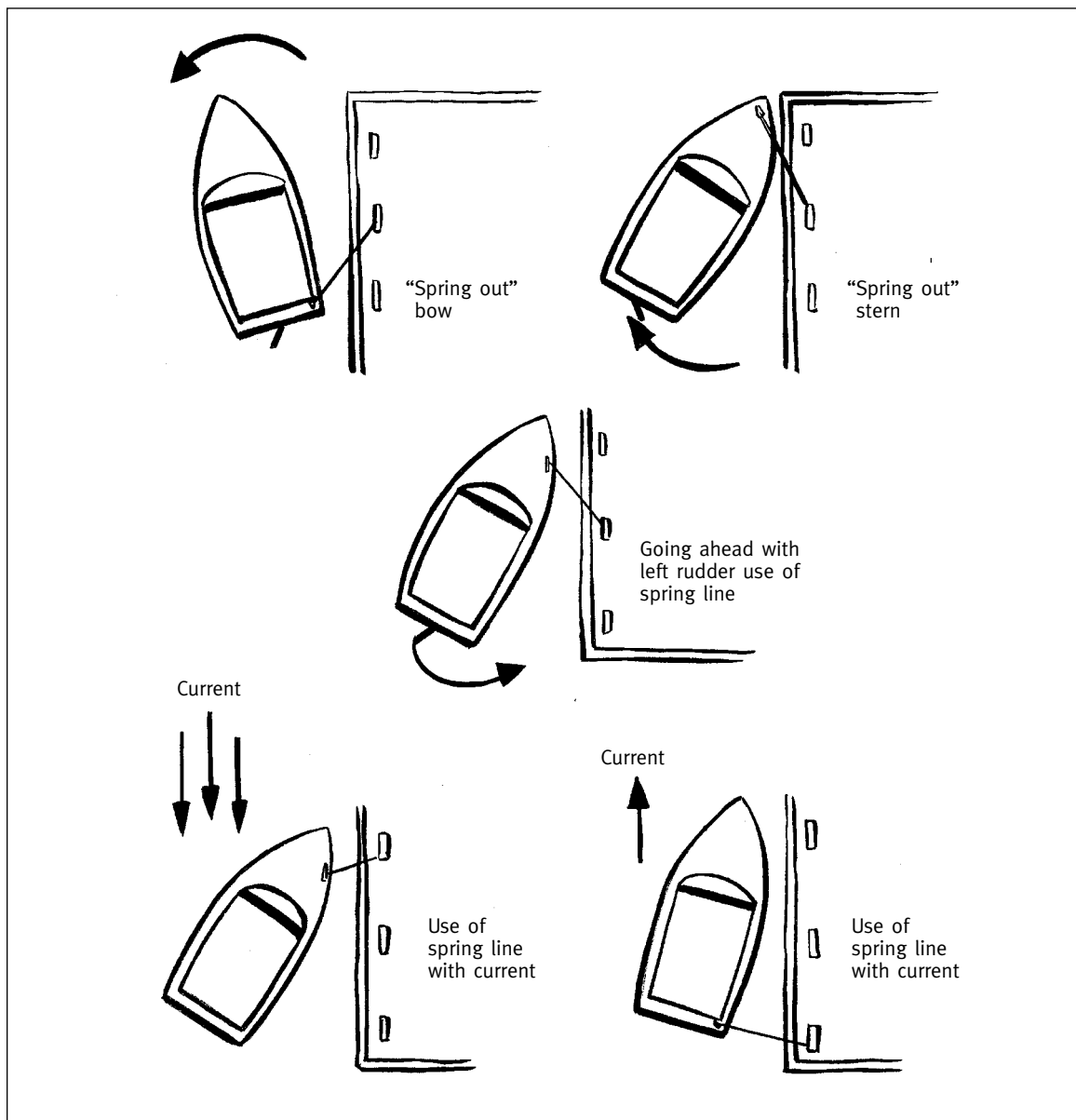

Figure 9.14: Basic spring lines maneuver and making use of a current

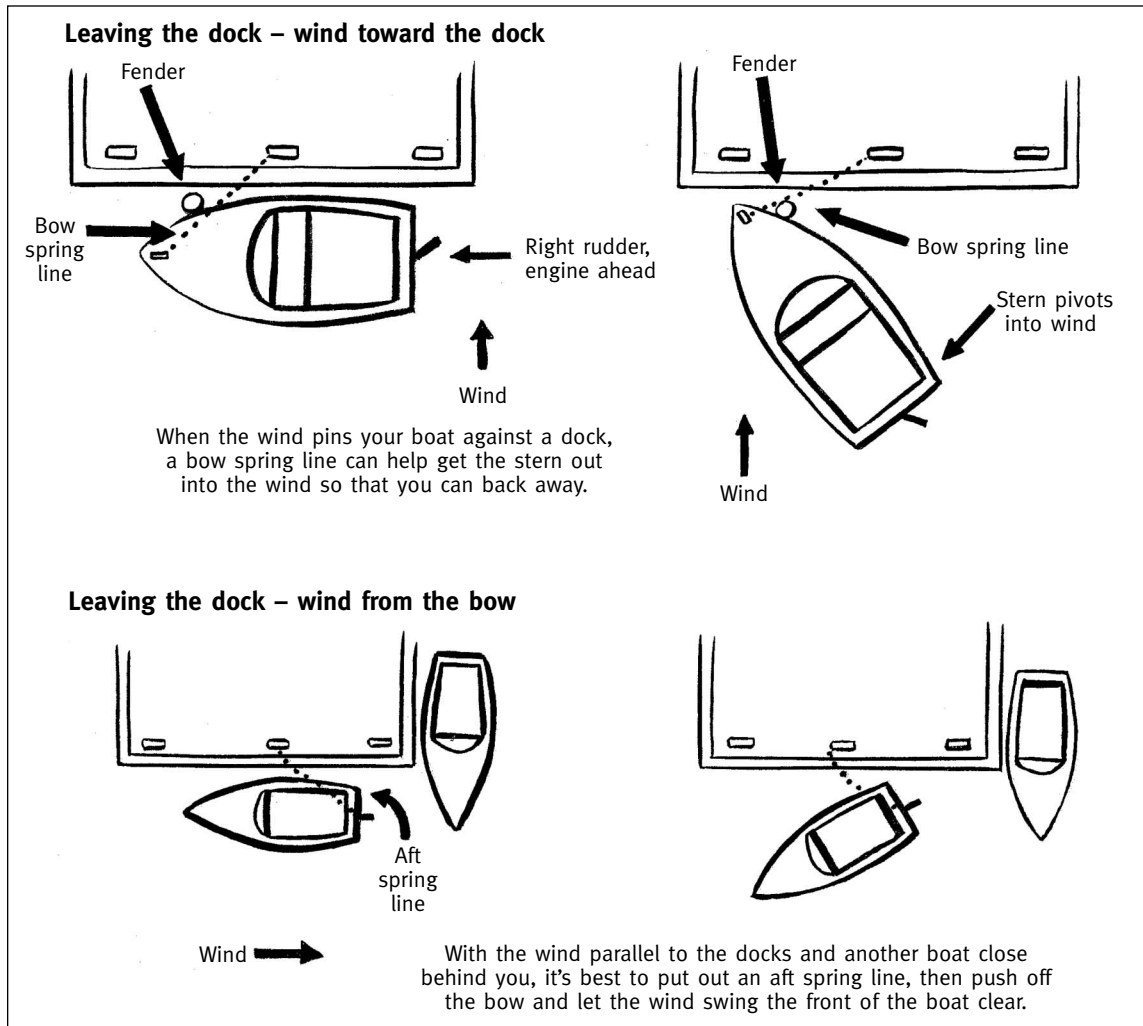

Figure 9.15: Leaving the dock with wind

Lines used under stress

Spring lines used to assist in undocking manoeuvres, especially in the absence of shore sideline handlers, should be rigged for slipping. Both bitter ends should be aboard the boat with the bight around the shore side attachment point. Then the spring line may be let go, or cast off, by releasing one end and hauling in on the other.

A spring line must be tended carefully to ensure that it does not foul the rudder or propeller or become caught on the dock when cast off. A spring line should never be tied off to a bitt or cleat when manoeuvring. A half turn around the selected deck fitting is usually all that is needed.

9.7.1.4 Clearing a berth

In many cases, an otherwise simple manoeuvre can be complicated by the presence of other craft or obstructions. Wind and/or current can also become a factor. Before manoeuvring, options should be evaluated and full advantage taken of prevailing conditions.

9.7.2 On board procedures on fast units

9.7.2.1 Accelerating

Now that all lines have been stowed and all fender taken in and now that you have cleared the berth, you are ready to get on your way. When operating boats that have a lot of engine power, always ensure that everybody is ready for your manoeuver. One method consists of asking: “Everybody secure?” Every crewmember should acknowledge by saying: “Secure!” Once every person on board has acknowledged, the operator can proceed. As one can see, this is an applied use of closed-loop communication (refer to the chapter on “Human factors” if you need to refresh your memory on closed-loop communications).

Accelerating with a displacement hull does not require a lot of attention. For planing hulls, however, things are different.

When you are ready to accelerate with a planing hull:

- Trim down all engines, if applicable;
- Push the throttle quickly initially so that your boat can rapidly get on top of its bow wave. Avoid doing this too quickly, or cavitation could result;
- Pull back the throttle to stabilize your speed;
- Trim your engines, if applicable, to the desired position, taking all conditions into account. If you have twin propulsion, ensure that both engines are running at the same speed.

9.7.2.2 Trimming outboard engines

Trimming the engines can achieve many beneficial results, including:

- better fuel consumption;
- better boat handling characteristics;
- higher speed.

Trimming can certainly make a difference, but it has to be well understood. By adjusting the trim angle of your engine, what you are doing is changing the point at which your boat rides its bow wave. When the engines are trimmed down, the bow wave will be closer to the bow; when they are trimmed, it will be closer to the stern.

In other words, the further upward you trim, the smaller the portion of your boat that touches the water will become.

This reduced surface contact explains why trimming results in higher speed and better fuel consumption. Decreasing the area of contact of your boat with the water, lessens friction. With less friction to work against, the engines can now push the boat more easily, allowing greater speed and better fuel consumption. There is a side effect, however. Since only a small portion of your boat touches the water when you are going at speed maximally

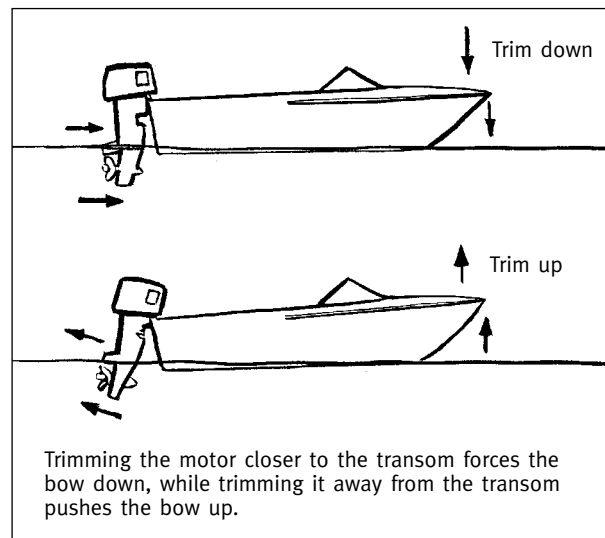

Figure 9.16: Trimming

trimmed upward, and since only a small portion of the engine leg is in the water, don't expect your boat to behave well if you do a sharp turn. The stern will have a tendency to skid outward. Skidding is to be avoided, because sudden deceleration could occur if your boat was to hit a parallel wave. The deceleration can be severe enough to cause serious injury, throw someone overboard or damage your boat.

Trimming upward will also cause the bow to rise. This can be quite desirable if you are to manoeuvre in heavy seas, since it might prevent your bow from getting stuck in a wave. Remember to slow down or to trim down the engines if you are to perform a sharp turn. Detailed boat handling in heavy seas will be discussed later in this chapter.

Trimming guidelines:

- In daily operations (patrol), one should trim the engines in an average position so that fuel consumption is lowered without risking skid in short radius turns;
- For maximum speed, trim until your boat reaches its top speed. Be extremely cautious when turning (slow down, trim down and/or do wide radius turns);
- In heavy seas, trim a little more than the usual daily operation trimming. Again, be cautious during turns;
- When manoeuvring at idle speed, keep your engines trimmed up a little. This will reduce your wake, give you better manoeuvrability and possibly prevent unexpected engines stalls.

9.7.2.3 Turning

In order to master turning, it is important to understand the notion of the pivot point. Compare the pivot point of a car with the one in a boat. During motion forward, the centre of rotation of a car is located somewhere at the back. In a boat, it is located near the bow.

On an icy road, if the rear of a car begins to skid, the centre of rotation will be displaced toward the front of the car. When this occurs, the car behaves like a boat. Conversely, during motion backward on a boat, the bow may begin to skid. When this occurs, the centre of rotation is displaced toward the stern, and the boat can be said to behave like a car. Many boaters are under the false impression that piloting a boat is exactly like driving a car. As you can see, this assumption is generally quite wrong! If it were true, all cars would be designed to have their rear end skidding all the time, or with the steering on the back wheels instead of the front wheels.

Several forces are acting on a vessel as it turns. Unlike automobiles, boats receive their impetus to change direction from the back of the vehicle. This force is provided by the engines, which explains why it is easier to turn when the engines are in gear. Although the bow of the vessel appears to change direction, it does not. It is the displacement of the stern of the vessel that gives the impression that the bow is moving. Another force that needs to be considered is the side force of the propellers.

The forces that need to be considered are the following:

- propeller's discharge current;
- propeller's side thrust;
- boat momentum.

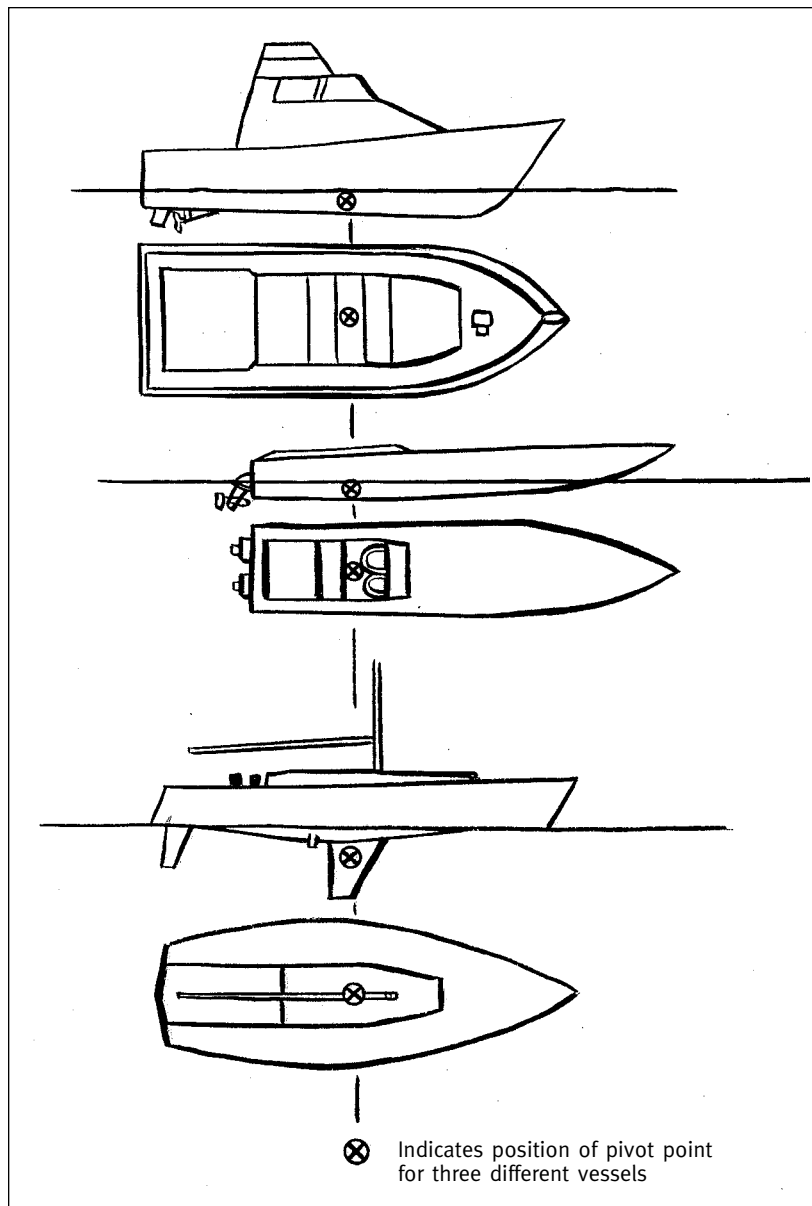

Figure 9.17: Pivot point

Discharge current

The discharge current of the propellers can be oriented at will when wheel of the boat is turned. The effect of this change in orientation is to move the force that drives the boat, forcing it to change direction. The stronger the discharge current, the stronger the force that will push the stern in another direction.

Side force

The side force of the propeller is also a force to consider. It can be an advantage or a disadvantage, depending on its action. Boats having two propellers (counter-rotating) are best equipped to take advantage of the side force of the propellers. Single engine boats are not so lucky. The result will be that single engine boats will be able to turn more easily on one side than on the other.

To understand the previous paragraph, let's review the theory of side force. A turning propeller creates a discharge current, but also has a tendency to go sideways. Depending on the engine used (twin propeller boats) or on the direction of the turn (single propeller boats), the side force can either increase or decrease "turning capability."

On twin propeller boats, it is a good habit to always use the "external" propeller when turning at slow speed, since it provides increased turning capability and allows for shorter radius turns.

Boat momentum

The momentum of the vessel will also affect the way it turns. Momentum is the force that tends to resist movement or changes in movement. When a boat is going forward, its momentum will make it continue to go forward. When the boat turns, the boat's momentum will elongate the turning radius and cause the turning arc to be somewhat distorted compared to the ideal theoretical arc.

9.7.3 Docking a vessel

Here are two docking techniques: the first technique can be used in most circumstances, while the other can be used under strong winds when the first technique fails. These techniques apply for both single- and twin-propeller boats, but the superior manoeuvrability of twin propellers provides some advantage.

9.7.3.1 Docking – general technique

Approach the dock initially at a 45° angle. Then, begin to turn to bring your vessel parallel to the dock. Initiate the turn so that less than 1.2 m (4 ft.) will separate your vessel from the dock. If you have twin propellers, always use the engine exterior to the curve to use the side force to your advantage and to maximize the force that drives your boat to turn.

Once your vessel is parallel to the dock, quickly turn the engines all the way toward the dock. Engage the engine on reverse gear to bring the stern toward the dock. Operators of twin propellers boats should use the other engine to maximize the effect. The combined effect of the engine and boat momentum, if well performed, should make your boat move slowly toward the dock. The engine should be kept on reverse gear until the forward movement of the boat is completely cancelled. To prevent the stern from touching the dock first, it may be necessary to turn the engine back to a more neutral position. Skilled operators will be able to manoeuvre their boat slowly toward the dock while keeping the boat perfectly parallel to the dock.

This technique is not hard to master, but it must be well understood. Misunderstanding the forces that apply to the vessel during this manoeuvre may cause the operator to commit various errors. The common mistakes that are committed are the following:

- bad approach angle;
- turn initiated too soon or too late;
- wrong turning radius;
- wrong approach speed.

Bad approach angle

Many operators have a tendency to approach at a very shallow angle ($< 45^\circ$). This approach will decrease the boat's momentum and the force needed to bring the boat toward the dock from a parallel position. Other operators may approach at a very sharp angle ($> 45^\circ$). This will increase the boat's momentum and may cause the boat to crash on the dock instead of moving slowly toward it. However, when strong winds blow your boat away from the dock, using sharper approach angles may counteract the effect of the wind. Using this technique to counteract the wind requires skill. Only experienced operators should attempt it.

Turn initiated too soon or too late

Another common mistake is to initiate the turn too soon or too late. In a turn initiated too soon, the distance between the dock and the boat, once parallel, will increase. The momentum may not be strong enough to bring the boat through that increased distance. To correct this, it may be necessary to steer toward the dock and to engage the engine in forward gear.

If the turn is initiated too late, the bow may hit the dock before the stern. Correcting this problem will require going full reverse while the engines are turned toward the dock. Engaging the engines full reverse when they are not turned toward the dock will cause the bow to swing toward the dock and worsen the problem!

Wrong turning radius

The turning radius is also important when commencing the final approach. A long radius (wide turn) will create less momentum than a short radius (sharp turn). A skilled operator will thus use a short radius, but keep a safety margin to allow compensation in case the boat gets closer than expected. In other words, if the bow was to hit the dock first, the operator should still be able to turn the wheel. If he or she turns the wheel all the way at the beginning, the only way to compensate if the bow gets too close to the dock will be to use the engines (and probably at high RPM!).

Wrong approach speed

The approach speed will also have an effect on the momentum. Going fast will increase the momentum and going slow will decrease it. Some operators have a tendency to use very slow speed when approaching. Under these circumstances, the boat momentum will be very weak, possibly not strong enough to bring the boat toward the dock.

Adapting the technique to the situation

When wind or current are working against you, pushing your boat away from the dock, you may adapt the previous technique to compensate. You can play with your approach speed, turning radius and approach angle. Against strong winds or currents, however, the following technique is safer and minimizes the risk of damaging your vessel.

9.7.3.2: Docking – strong winds or currents technique

Approach the bow slowly toward the dock. Choose an approach angle that will prevent the bow of your boat from catching the wind (or current) and causing it to swing away from the dock. Under very strong winds, it may even be necessary to use an angle close to 90° .

Install a bowline to secure the bow to the dock. Use a strong line and make sure it is secured to strong fittings, because it may have to sustain heavy tension. The bowline should be long enough to allow the boat some degree of freedom

Turn the engines and engage forward to bring the stern toward the dock. Use as many fenders as necessary to prevent any damage. Once parallel to the dock, secure the stern.

The two techniques above can also be used to board a stationary vessel. The only additional difficulty will be to perform a perfect approach to immobilize your boat right next to the other.

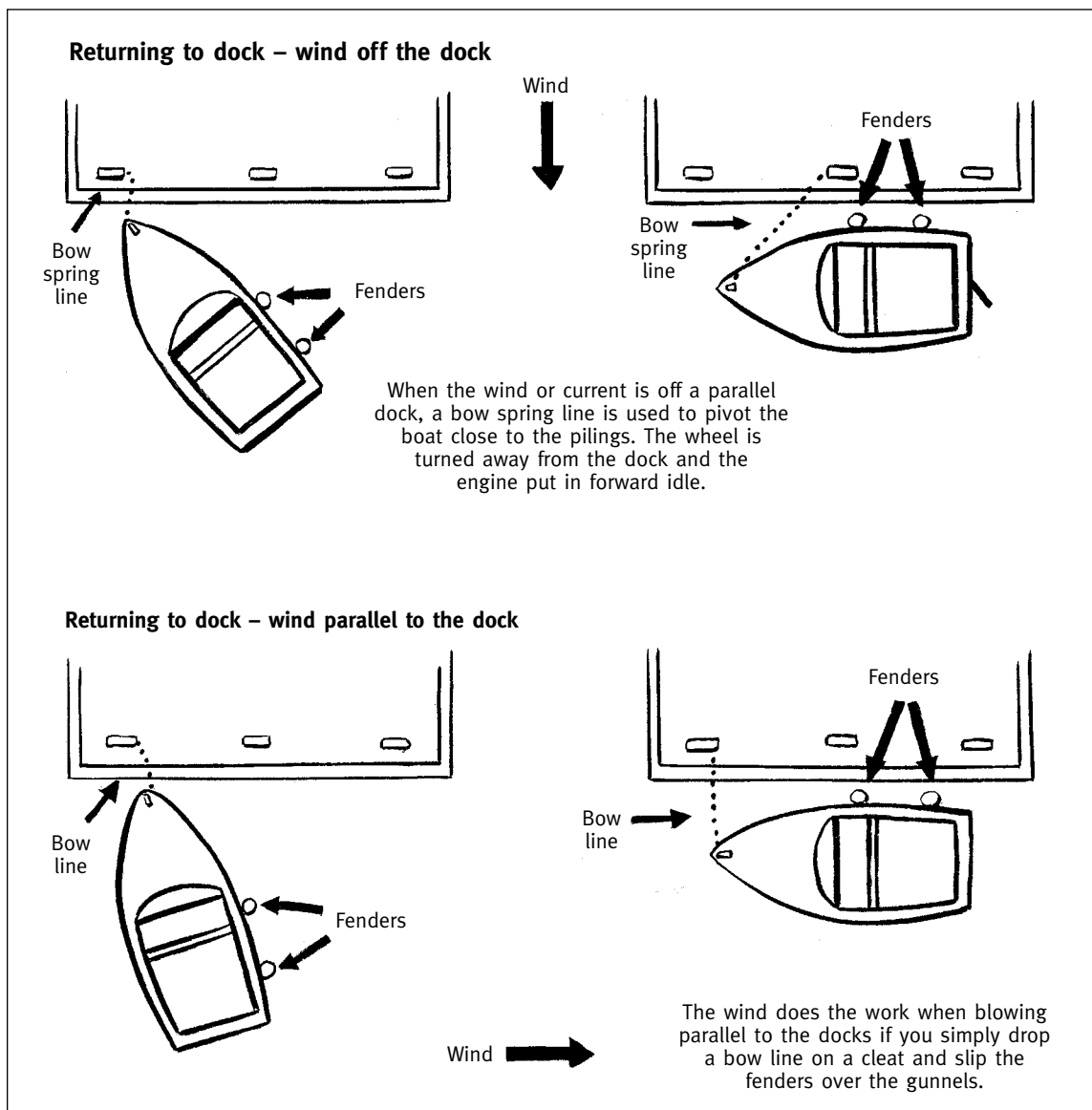

Figure 9.18: Docking with wind or currents

9.7.4 Beaching a boat

Sometimes it may be necessary to beach your unit during the course of an SAR mission. Here is the procedure for beaching a boat:

- Evaluate the situation (consider tides, winds, currents and type of bottom);
- Tilt your engines;
- Approach slowly and watch the depth;
- When you are about to touch the bottom, use a short burst of the engines to sit your boat on the bottom;
- When it is time to leave, back up slowly. It may be necessary to use poles or oars to help the process. Putting some weight at the stern can also help, since it will raise the bow. The use of a ground tackle can also help when it is time to get out. It will also prevent your vessel from being driven too far onto the shore.

It is important to ensure that the water cooling system of the engine is working throughout the beaching procedure. The water intake is very likely to get obstructed during manoeuvring in shallow water.

9.7.5 Anchoring a boat

When you need to anchor a boat, follow this procedure:

- Find an appropriate spot and check the depth;
- Calculate the amount of line you will need to let go of. The recommended scope is 5 to 7 times the water depth plus the height of the freeboard. Longer scopes are required under bad weather conditions;
- Check headway, thread the anchor line through a chock and slowly drop the anchor to the bottom;
- When the anchor is resting on the bottom, back up your boat until the desired scope is achieved;
- Stop your boat again and secure the anchor line to a cleat if this has not already been done;
- Back up to see if the anchor is holding on the bottom. While it is still attached to the cleat, feel the tension in the anchor line with your hand. If no tension develops when you are backing up, the anchor is probably not holding.

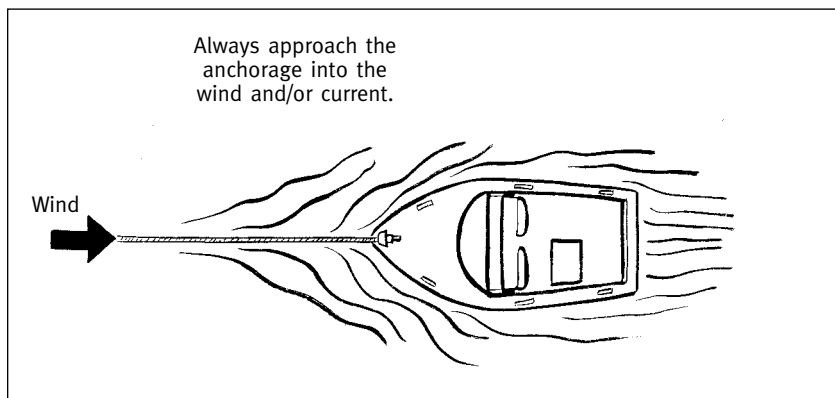

Figure 9.19: Approaching an anchorage

9.8 ADVANCED BOAT HANDLING TECHNIQUES

9.8.1 Manoeuvring alongside another vessel (pacing)

Many missions will require going alongside, in contact with another vessel. This activity can involve anything from a rigid hull inflatable boat (RHIB) going alongside a large merchant vessel to a large fishing vessel going alongside a small open boat. Comparative vessel size and mission requirements all influence manoeuvring practices.

9.8.2 Determine approach

When you determine your approach, consider prevailing weather and currents, location, vessel sizes, traffic density. Ensure that you discuss your intentions with the other vessel's master.

Note: If you are going alongside a disabled vessel or one that is underway but dead-in-the-water, compare relative drift rates. When approaching a larger vessel with a low drift rate, approach from leeward. If approaching a smaller vessel, determine whether your vessel is making a wind shadow that will slow the other vessel's drift. If so, an approach from windward may be better, and your vessel will then protect the smaller vessel from winds and waves.

CAUTION

Do not approach from leeward if it will put your vessel and crew in jeopardy, whether from shoal water or obstructions farther to leeward, or from smoke or hazardous fumes.

9.8.2.1 Course and speed

Maintain your vessel's course and speed in such a way as to make your approach as smooth as possible for both vessels.

Most large vessels will not be able to alter course significantly in a limited area to provide ideal along conditions. If it is not practical for the large vessel to change course, have it reduce speed so that the effects of bow and stern waves are reduced.

Small vessels do not ride well when making way in any kind of winds or seas. Unless the weather is perfectly calm, have a small vessel maintain a course and speed that makes for safe, comfortable navigation and mission completion. Ensure speed is slow enough for safely coming alongside, but fast enough for both vessels to maintain steerageway.

Many sailing vessels are much more stable while under sail than when powering or drifting. Consider coming alongside while the other vessel is under sail. Be sure that spars, standing or running rigging or control lines do not foul either vessel. Discuss the situation with the other vessel's master.

CAUTION

Make sure the other vessel does not begin to alter course while you are approaching or coming alongside. If this happens, break off and re-approach once the other vessel is on a steady course.

9.8.2.2 Approach from leeward and astern

A large vessel will create a wind shadow and block most of the seas. This creates a favourable situation like that of mooring to the leeward side of a pier. Though a small vessel will probably not block the elements to any degree, approach from leeward to control rate of closure and limit any effect your vessel will have on the small vessel drift.

Note: If approach from leeward is not possible (given sea room or other conditions like smoke or hazardous vapours), use caution to prevent being pinned up against the side of another vessel. A bow-in approach might provide the most manoeuvrability.

9.8.2.3 Lines and fenders

Rig lines and fenders as needed. Remember, the more fenders you use, the better.

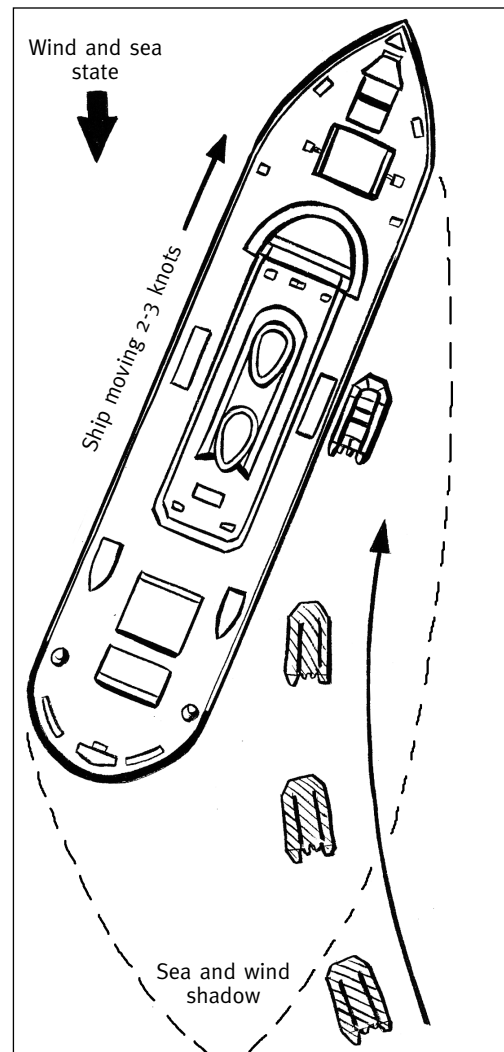

Figure 9.20:
**Approaching from
leeward and astern
in the wind shadow**

9.8.3 Going alongside

After completing your approach preparations, go alongside. Determine where you want to make contact.

WARNING

Pick a contact point well clear of a larger vessel's propeller (including in the area of suction screw current), rudder and quarter wave. Forces from these could cause loss of control.

9.8.3.1 Begin to close

Conditions permitting, match your speed to the other vessel, then start closing in from the side. Close at a 15° to 30° angle to the other vessel's heading. This should provide a comfortable rate of lateral closure at no more than one half the forward speed. If your initial heading was parallel to the other vessel, you will have to increase speed slightly when you start to close at an angle.

9.8.3.2 Use a sea painter

In some instances, a sea painter may be used in coming alongside a larger vessel that is underway. The sea painter is a line used to sheer a boat clear of a ship's side when underway or at anchor, hold a boat in position under hoisting davits, or occasionally to hold the boat alongside a ship in order to embark or disembark personnel. It leads from the larger vessel's deck, well forward of where the boat will come alongside.

Follow these steps when securing a sea painter to the boat:

- Use a position well forward, yet aft of the bow on the side of the boat that will be alongside the larger vessel;
- Lead it outboard of handrails, stanchions and fittings. It makes a pivoting point on the "inboard" bow of the boat;
- Never secure the sea painter to the boat's stem nor to the side of the boat away from the ship. If a sea painter is secured to the "outboard" side of the boat, capsizing could result.

As both the boat and ship have headway, the pressure of water on the boat's bow will cause it to sheer away from the ship. Use this force to control sheer using a touch on the helm or by taking advantage of the ship's side waves. The sheer out can also be enhanced by catching the current on the outer side of the bow wave.

Riding a sea painter helps maintain position and control of the boat. Follow these steps:

- Come alongside of the vessel, matching the course and speed. Once you are close aboard the larger vessel and forward of the desired contact point, ask the ship to pass the sea painter;
- Receive the sea painter and secure it to an inboard cleat just aft of the bow;
- The sea painter is usually passed with a heaving line. Quickly haul in the heaving line and adjust the boat's heading and speed to control slack in the sea painter so that these lines do not get into the boat's propellers;
- Reduce your speed slowly and drift back on the painter (ride the painter);
- Use helm to hold the boat at the desired position alongside or at some distance off the ship;
- If the set is towards the ship, apply rudder to sheer the bow off. If your boat is too far off, apply rudder to sheer the bow in. The forward strain on the painter will pull the boat and provide steerageway.

Notes:

- *When sheering in or out, apply rudder slowly and be prepared to counteract the tendency of the boat to close or open quickly.*
- *For an approach to a vessel at anchor in a strong current, the sea painter provides a means to lay alongside. Procedures are the same as those for a vessel making way. Approach from leeward, against the current.*

9.8.3.3 Make and hold contact

Make contact with the forward section of your boat (about halfway between the bow and amidships). Use helm and power (or a sea painter) to hold the bow in to the other vessel at the same forward speed. Do not use so much helm or power that you cause the other vessel to change course.

9.8.3.4 Conduct the mission

When alongside, do what has to be done. Minimize time alongside. If necessary and if conditions permit, “make fast” to the other vessel rather than relying on power to maintain contact.

9.8.3.5 Clearing

When you are clearing the side, avoid drifting towards the stern of the vessel. Follow these steps:

- Sheer the stern in with the helm to direct the bow out;
- Apply gradual power to gain straight, relative speed.

Notes:

- *If you are using a sea painter, its strain will sheer the boat clear;*
- *Use enough speed on a sea painter to get slack in the line, then cast off once clear. Ensure that the sea painter is hauled back on board the larger vessel immediately to keep from getting in caught in your screws. Avoid the rope in the water;*
- *In the case of a twin screw vessel, go ahead slowly on the inboard engine. This technique also helps keep your boat clear of the other ship's side.*

CAUTION

Never back down when trying to clear another vessel that is making way.

9.8.4 Close quarter situations

The key to success when manoeuvring in close quarter situations is to be gentle on the throttle. You are less likely to damage anything if you manoeuvre at turtle speed. Single engine boats should be very cautious approaching narrow areas, since they are much less manoeuvrable than twin-engine boats. Boats equipped with two engines can use some additional trick to manoeuvre in narrow places. The twin-propeller pivot turn allows twin-propeller boats to perform 360° turns without any forward or backward movement. Again, be aware that the pivot turn will work only when current and wind are negligible.

9.8.5 Using winds and currents to advantage

Winds and currents can be used to advantage in many situations. Forward movement can be cancelled by wind or current, so it is possible to get your vessel moving on either side using the wind or currents. Knowledge of how the wind affects a vessel is very important in all close quarter situations, such as docking, undocking, recovery of an object in the water, or manoeuvring close to another vessel. During manoeuvres from a downwind or leeward side of a vessel or pier, look for any shadow the vessel or pier makes by blocking the wind. Make allowance for the change in wind by planning manoeuvres with this wind shadow in mind.

9.8.6 Station keeping

Station keeping is one of the most difficult and most common fundamentals used in boat operations such as hooking up a tow, person in the water (PIW) recovery and personnel transfers. Before you can station keep, you need to be familiar with your conditions. Begin by the answers to such questions as:

- How hard is the wind blowing, and from what directions?
- What is the swell direction?
- From what direction are the sea and current?

It is very important that all of these factors be considered; each will have a separate but equally important effect on the boat. The objective of station keeping is to be able to hold your bow square into the most predominant force while keeping your boat in one position. Normally, the swell will be your predominant force, although the wind and sea may be more predominant, depending on your area and circumstances. For the purpose of this chapter, the swell will be considered the predominant force. If the wind and seas are not from the same direction as the swell, they will push against the sail areas of the boat, forcing the bow to fall off the swell to either port or starboard side.

The coxswain needs to be aware that this is happening and begin corrective measures. The power of the force against you needs to be counteracted with the same amount of force. The coxswain will need to use both the rudders and throttles in conjunction with one other. Again, sometimes this manoeuver only takes a little power, and other times it may take a lot of power. Use whatever force is necessary to keep your bow from falling off the swell, and keep your boat in one position. If the wind is pushing you on the port side, push back by pivoting the boat port and using your wheel to port, applying enough power to accomplish the results you want. Drive the boat : don't let the boat drive you!

9.8.6.1 Winds and current

The best way to maintain your boat's position against currents or wind is to keep your vessel parallel to the wind or current (whichever is strongest). When this is not possible, you will need to compensate as the wind or current tries to push your vessel's bow. Most vessels have a "point of no return." As the angle between the wind and your vessel increases, it will become harder and harder to maintain your position. At the point of no return, you will lose control, and maintaining position will become impossible. The factors that will set this point of no return are:

- height of the bow (above the water);
- draft;
- vessel length ;
- vessel weight ;
- the presence of any "wind-catching" structures;
- engine characteristics (number and power).

To effectively station-keep against winds or currents, keeping your boat within the points of no return is crucial. Station keeping can also be accomplished by keeping the engines directly in the wind.

9.8.6.2 Waves

Waves will cause two kinds of displacement: vertical displacement and horizontal displacement. There is nothing that can be done to counteract vertical displacement, but horizontal displacement can be counteracted with careful use of the engines.

When the wave arrives, it will push your boat forward. When you are on top of the wave, forward displacement will stop and backward movement will begin. To station-keep in the waves, you must compensate for that forward and backward movement. Gentle compensations with the engines can achieve this goal. Be aware that most people have a tendency to overcompensate by quickly and abruptly shifting between forward and reverse. This practice is dangerous, since it may increase the chances of engine failure (stalls).

9.8.7 Backing

Backing your boat in a straight line is very important and very difficult. Most coxswains cannot back the boat any distance without allowing the bow to fall off the swell.

Backing is used in the same situations as station keeping, and all boat drivers need to master it. Before you can start backing, get your bow square to the swell, engage both throttles in reverse, put your helm to amidships and start applying a small amount of power, increasing power gradually. As the boat begins to back, the bow will start to fall off to one direction or the other, depending on wind. As the bow slips to whichever side, begin to counter with more throttle control and rudder. For example: if the bow slips to port, counter by shifting your rudder to port, increase starboard reverse power and decrease port reverse power. You will observe the bow beginning to straighten up to starboard. As it does, correct your rudder back to amidships and bring your throttles back to an even RPM. This process continues throughout the entire process. Keep countering with rudder and throttles until you have backed to desired position. If your bow falls off too far before you begin to counter, you will not be able to correct by backing without subjecting your boat and crew to a very uncomfortable ride. If this situation is not corrected quickly enough, the boat will fall completely to beam seas. When this happens, your best corrective action is to use whatever power is necessary to get your bow back square into the swell. Then, begin backing again. You should never back on the face of a large swell; if this manoeuver is done incorrectly, the swell may take complete control of your boat. The swell action will amplify the degree to which the bow fell off the swell, thus making your situation very difficult, if not impossible, to correct.

If you keep your bow square to the swell of the most predominant force and use proper amounts of power for different situations, your boat can be handled relatively easily. It takes many hours of training and practice to become proficient.

Note: If you leave your rudder locked over in one direction while backing and pull your power off, the boat's rudders will take over and you will swing very dramatically in that same direction. Rudders need constant propeller force to prevent this from happening. When you have finished backing, immediately shift your rudder amidships and apply forward propulsion.

9.8.8 Shallow water manoeuvring techniques

Vessels engaged in SAR are quite likely to have to manoeuvre in shallow water for tasks such as assisting vessels. Most small units are able to manoeuvre in very shallow water. When manoeuvring in shallow water, follow these guidelines to prevent damage to your boat:

- Evaluate the situation (consider tides, winds, currents and type of bottom);
- Tilt your engines;
- Move slowly and watch the depth;
- Avoid using the engines at high RPMs;
- Always have someone as a lookout. Never lose situation awareness.

When the engines are tilted, the risk of damaging the propellers is minimized. The drawback is that your propeller discharge current is now oriented upward. This will considerably affect the manoeuvrability of your vessel. It will also make it impossible to use the engines at high RPMs, since doing this will cause the propeller to go deeper and may increase the risk of damage. Given that you will not be able to use the engines to their full power, never attempt to navigate in shallow water when winds or currents are strong.

In extremely shallow water, the bottom has an effect on the movement of the vessel. Slow down in shallow waters. In extremely shallow water, the vessel's stern tends to "squat" and actually moves closer to the bottom.

Avoid trimming up much at speeds between 1000 and 2000 rpms in the shallows, because this pushes the stern down. The boat actually runs deeper in the water than it would if you had the motor in the full down position.

During acceleration, excessive power applied causes the stern to squat. Large stern waves and a raised bow result. The coxswain will lose forward visibility until the craft attains planing mode.

Do not make the mistake of trimming up at low speeds and then trying to put the boat on plane. The motor will roar and the water will fly, but you will go nowhere fast.

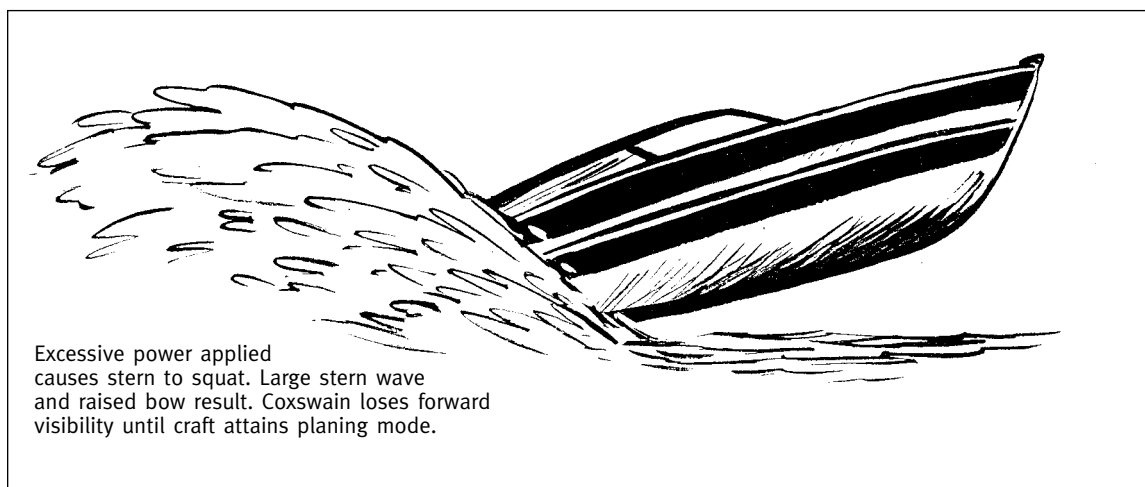

Figure 9.21: The phenomenon of "squat"

9.9 HEAVY WEATHER BOAT HANDLING

At times, vessels engaged in SAR are required to operate under extreme weather conditions. When things start to go wrong in these conditions, they will happen quickly and may conspire to make your task even more difficult. The SAR vessel must be prepared for heavy-weather operations at any given time. A few preventive measures can go a long way towards making your voyage successful and as “close to pleasant” as possible. This section will give you a basic understanding (by no means complete knowledge) of how boats handle in different conditions. Full knowledge will come with experience.

The coxswain will ascertain that heavy-weather conditions exist or are forecasted. Vessels engaged in SAR should be ready for full response at any time, but take the time to check your vessel’s preparedness even more carefully when you are venturing into heavy weather.

- Is all loose equipment or personal gear in its proper stowage place and secured for sea? Are hatches, windows, ventilators, etc., secured? Is shore-based standby equipment required? (Ready locker?) Stow required standby equipment securely;
- To increase stability, ensure that freeing ports are working, bilge is dry and all fuel tanks are full. You should also distribute the equipment evenly;
- Are life lines and harnesses rigged or in the ready position?
- Are all personnel dressed in proper protective clothing / personal safety equipment? Are helmets to be worn? Are seat belts ready?
- Is there adequate fuel for an extended period of time at sea?
- Prepare required charts and equipment before leaving the harbour. Are intended courses, clearing lines, etc., laid out on the charts?
- Consider removing non-essential towline covers or similar ancillary equipment in order to eliminate the requirement to do so at sea;
- Is crew briefed on any special considerations or hazards particular to the tasking or conditions expected?
- In heavy weather, it is advisable to reduce speed. This will allow for more comfortable conditions aboard and assist in maintaining better control of the vessel;
- Rough sea conditions require that all passengers be seated and remain so. In small vessels, insist that passengers sit as low as possible even if they must sit on the floorboards or cabin sole. This will help lower the centre of gravity of the vessel and make for greater stability.

Boat handling in heavy weather is similar to boat handling in calm weather. Although the manoeuvres are the same, the conditions you are in will require you to use more power, and this will necessitate greater concentration and alertness from both coxswain and crew.

Before the boat even gets underway, there are a number of items that need to be checked.

9.9.1 Heavy seas

In calm weather, handling a boat under power at sea is no different from handling one anywhere else, except that there is a lot more room. If there are waves of any size, you must understand the effects they will have on your boat and crew.

The discomfort that can be experienced on boats in heavy seas is hard to describe to those who have not experienced it before. It can drain all energy and willpower at the times they are needed most. It can hamper the capacity for making a rational and prudent decision in tough situations.

Heavy seas will cause rolling, pitching and yawing. It is important to know how to minimize these motions to ensure a safer and more comfortable ride.

9.9.1.1 Rolling

Dangerous rolling is preceded by discomfort, or at least a small period of concern. As explained before, rolling is caused when running beam to the seas or slightly quartered off the seas. To correct, alter your course. This interrupts the frequency of the period of contact with the beam seas. If you just slow down in this situation, there will be no difference in the motion of your boat because the speed has no bearing on the frequency of beam seas. When quartering the seas, you may also experience the rolling motion. If you are experiencing a great deal of rolling while quartering, your best course of action is to slow down, again interrupting frequency period. With the combination of altering course and speed, you and your crew should have a more comfortable ride.

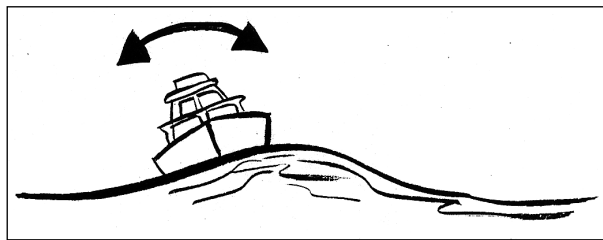

Figure 9.22: Roll

9.9.1.2 Pitching

Severe pitching will fatigue or injure your crew long before it damages your boat, and is the least dangerous in heavy weather. Violent pitching can be corrected in the same manner as correcting rolling: alter course and/or speed, interrupting frequency of period of wave encounter. In heavy weather, watch for the possibility of very deep troughs so that the boat can be immediately slowed to reduce the impact as the boat falls into them.

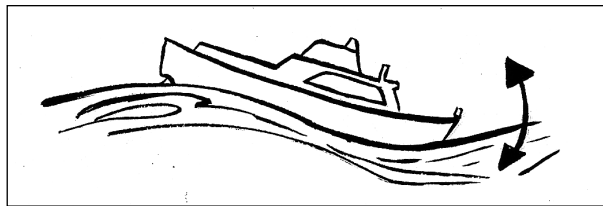

Figure 9.23: Pitch

9.9.1.3 Yawing

Running stern-to in heavy seas requires intense concentration, as steering corrections must be made the instant you feel the stern of the boat being lifted by the oncoming swell. If you are traveling too fast and not paying attention, the

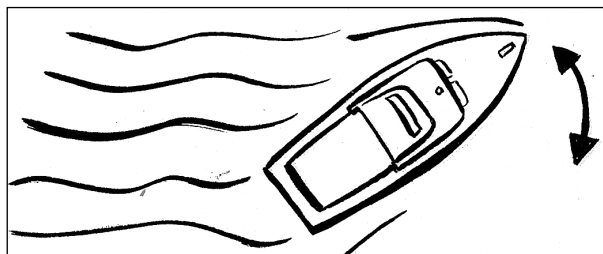

Figure 9.24: Yaw

wave will lift up the stern and broach the boat in one direction or the other. You may not be able to correct if the wave gets a hold of the boat and begins to surf it. Once the wave has control of your boat, you are at the mercy of whatever it wants to do to you, such as roll, pitchpole, or strike a floating object. You will have no control, Therefore, pay attention so you can apply corrective measures soon enough to prevent any disasters.

To keep from yawing, realize that the wave is approaching your stern. If the wave approaching is a large steep wave and the possibility of surfing is great, slow down before the wave gets to you and allow it to flow underneath you. After the wave goes under the boat, increase your power to the original RPM. If you are operating in fairly regular seas, steer the boat as you normally would. Turn in the direction towards which the stern tends to slip. No increase or decrease in power will be necessary as long as the swells are not big enough to cause your boat to surf. If you find yourself being lifted up and surfed, increase your power. As the bow begins to dig into the trough and veer to one direction, keep power on and turn the helm hard in that direction. This action will cause your boat to dig itself out of the wave and climb up over the top. Another method is to do an “S” turn. The “S” turn is a very effective and safe manoeuver as long as it is done in time and done correctly. It is the most often-used manoeuver.

9.9.1.4 Running in following seas

When running in following seas, there is a danger of burying the bow. The vessel will slow very rapidly or come to an abrupt stop. The factors that will contribute to making this happens are:

- the attitude of the bow as it meets the back of a wave (which is determined by the speed and direction of the boat with respect to the wave);
- the shape of the waves (there is a greater chance of burying the bow in steep, close waves);
- hull type and design (there may not enough lift in the bow).

To prevent the burying of the bow:

- ease off the power to stay on the back of the present wave;
- quarter off the sea;
- change your angle of attack;
- if the sea is breaking astern, use the boat’s reserve power to outrun the waves or turn off your course to starboard or port;
- powering-on to keep a bow-up attitude at the crest of a wave will prevent burying the bow. But as the bow falls, no increase of power will make enough difference to pull the bow up, and putting more power on will just cause the boat to crash harder into the back of the next wave.

9.9.2 Operating a vessel in excessive wind

Wind affects the boat AND the sea state, and each requires just as much attention and concern. No matter what operational function you are conducting, e.g., man overboard, towing, or just swimming, you need to be aware of the wind. As wind increases, so do the seas, and with the combination of both, the boat is more and more difficult to handle. Reduced speed causes increases in both wind effect and manoeuvring difficulty. If the boat

is dead in the water, the wind will push against any sail areas, causing the boat to turn in the direction in which the wind is blowing. The harder the wind is blowing, the faster the boat turns, and the harder it is to counteract. This action plays an important part in boat handling, especially if you are operating in close quarters, making a towing approach, or just trying to keep station.

9.9.2.1 Counteracting the effects of the wind

To counteract the wind and/or seas, pivot the boat in against the wind. Don't be afraid to use the power available to you; sometimes all it takes is very small amounts of throttle, using one engine at a time. Other times it might take massive amounts of power using both throttles together. There is more than one way of using your power; the method you need depends on the amount of wind blowing against you. If you are running into the wind, resistance will reduce your speed in proportion to the amount of sail surface that is in contact with the wind. There is no real corrective action for this, but coxswains need to be aware of it. In the same manner, if you are running with the wind on your stern, and depending on amount of sail area, your speed will increase. As long as the coxswains and their crews are aware of their surroundings and of what is going on with their boat, all corrective actions can be made in ample time.

9.9.3 Heavy weather piloting

The distinction between "piloting" and "navigation" is outlined in many respected publications, including Dutton's Navigation and Piloting and Bowditch's Practical Navigator. This chapter is designed to offer techniques that are unique to operations in heavy weather situations.

The importance of sound piloting is well described in Dutton's:

"Piloting requires the greatest experience and nicest judgment of any form of navigation. Constant vigilance, unfailing mental alertness, and a thorough knowledge of the principles involved are essential ... In pilot waters there is little or no opportunity to correct errors. Even a slight blunder may result in disaster, perhaps involving the loss of life."

Some might consider this statement melodramatic, yet, in essence it is true. Any situation that might be stressful or confusing will be compounded by the dimension of heavy weather. The loss of life may not involve your crew, but if you are unable to pilot a vessel to persons in distress, you will jeopardize the lives of mariners who entrust their lives to the abilities of boat operators.

9.9.3.1 Preparation

Being prepared is not limited to having proper or sufficient equipment aboard. Preparation for a heavy weather case involving piloting (which all must if you leave the dock) can begin months before the mission.

The primary tool for ensuring success in any piloting task is local knowledge. The ability to quickly match objects seen visually or on radar with charted objects will enhance a coxswain's capabilities. Naturally, calm weather affords the best situation for studying your area when you are underway, but observing your area of responsibility (AOR) from land or sea during heavy weather will enable you to identify areas that become hazardous in inclement weather. Of course, none of the tools available are useful if you are not well versed in how to use them. No amount of studying or classroom instruction can substitute for underway training. You should take every opportunity to pilot, no matter what the conditions may be. The wise coxswain "overnavigates" the boat during fair weather so that he or she can acquire the skills to navigate in poor weather without fear or nervous strain.

Piloting in heavy weather can be enough of a challenge without the additional burden of substandard equipment. There are a few items that are absolutely necessary. Some of those listed below will ease the stress of any piloting process.

Often the most neglected but critical pieces of piloting equipment is the chart. Naturally, an up-to-date chart in good condition is required. Effective heavy weather piloting is based on the assumption that the coxswain must be topside, near the radar, and standing up so that he or she can see all around the vessel and maintain strong lines of communication with the crew. Anyone who has ever tried to lay down a trackline or obtain a fix and plot it while underway knows how awkward it can be. To ease this problem, prepare charts in advance. Plastic-covered or laminated chartlets are easy to correct. Lay down the most common routes that you normally take in your area of responsibility, add some DRs for usual speeds traveled, some radar ranges and distances between fixed objects, and you will gain valuable time underway. It is unrealistic to have tracklines laid down for every position in the area, but you will have information to get you to a point where you can "jump off" from a preset trackline and pilot to datum. The initial time you will save will enable you to think about the next stage in your response to a distress call.

9.9.3.2 Chart preparation

Have the right chart for every mission. All too often, coxswains try to cover their entire operating area with one chart. Piloting in the harbour or river with a large-scale coastal chart is unsafe. Prepare your charts in advance with as much information as possible without cluttering them to the point of illegibility. The courses from your dock to your entrance are probably consistently the same. Exceptions may occur during heavy weather where the entrance breaks and some alternate course might be needed, depending on the direction of the seas and wind. Draw out tracklines from the point of departure to a position where you would normally station-keep before crossing the bar or inlet. Along the trackline, lay out some DR positions to aid in determining speed over ground and position. Be realistic about DRs on boats. If you have a three-mile trackline on a constant course with good water on either side, three-minute DRs may be excessive and detract from your ability to monitor what is happening around you.

9.9.3.3 Chart labeling

Label your chart with all pertinent information. The chart should be labeled using common terminology and should be neat and easily readable. A good guideline to follow is that anyone should be able to pick up your chart and use it to safely pilot the area. Write course directions and their reciprocals, specifying true or magnetic. Distances on all radar ranges and between aids or fixed objects along the track will also help in computing speed. Do not use a red pen or pencil, as neither will not show up under a red light. Using a high-lighter pen on your chart will help in readily identifying important information.

9.9.3.4 Radar ranges

One of the most underused methods in piloting is radar ranges. Having a beam radar range at your DR positions take a great deal of the guesswork out of navigation. If you have predetermined ranges laid out, you will be able to see at a glance how far left or right of track you are, well before you reach the DR position. Having these ranges will also allow you to repeatedly make minor changes to your course instead of major changes at each DR position. To simplify matters even more, lay out distances fore and aft as well. Often it is impossible to have a fixed object directly ahead or astern, but even an object 10° to 30° off the bow or stern will give you an approximation of your position up your trackline. These fore and aft ranges are also critical in computing speed over ground using the three-minute rule and its variations. If you are tasked with piloting to datum, lay out ranges from known points of land or from floating navigation aids to datum. Try to use ranges as close as possible to directly ahead or astern and to directly abeam. As you approach the position, it will be easy to determine if you are right or left and too far up or down the track. Then you can adjust your course as necessary.

9.9.3.5 Chart stowage

Although it may sound trivial, it is actually important to learn to fold your chart properly. Hopefully, you will have taken the time to make chartlets or laminated charts of a workable size with the most common routes and positions already on them. But a chart cannot be prepared for every possible position, and it is very likely that you will have to plot a position on a chart, lay out a trackline, and go. If the urgency of the case puts you on a boat heading to sea in heavy weather, take the time to fold your chart so that it is usable. You will be unable to unfold the chart every time you need the distance scale or compass rose. If possible, datum and ranges to datum should be on the same side of the folded chart. Do as much of the chart work as possible before you leave the dock. Everyone has felt the urgency of getting underway immediately, but remember, you are ultimately responsible for the safe navigation of your boat and no level of urgency will be an excuse for running aground or colliding with another vessel.

CHAPTER 10 – TOWING

10.1	General	10-5
10.2	Safety	10-5
10.2.1	Communications	10-5
10.3	Forces in towing	10-6
10.3.1	Static forces	10-6
10.3.2	Momentum	10-6
10.3.3	Friction resistance	10-6
10.3.4	Form drag	10-6
10.3.5	Wave making resistance	10-7
10.3.6	Wave, spray and wind drag	10-7
10.3.6.1	Wave drag	10-7
10.3.6.2	Spray drag	10-7
10.3.6.3	Wind drag	10-7
10.3.7	Combination of forces and shock loading	10-8
10.4	Towing equipment	10-10
10.4.1	Towlines	10-10
10.4.2	Towline reel	10-11
10.4.3	Towing pendants and bridles	10-11
10.4.3.1	Pendant	10-11
10.4.3.2	Bridle	10-12
10.4.4	Messengers	10-13
10.4.5	Chafing gear	10-13
10.4.5.1	Preventing chafing damage	10-13
10.4.5.2	Thimbles	10-13
10.4.6	Deck fittings and other fittings	10-13
10.4.6.1	Condition and inspection	10-13
10.4.7	Kicker hook	10-14

10.4.8	Using a drogue	10-14
10.4.8.1	Prepare the drogue gear	10-15
10.4.8.2	Pass the drogue	10-16
10.4.8.3	Rig drogue for deployment	10-16
10.4.8.4	Deploy the drogue	10-16
10.4.8.5	Shortening up and recovering the drogue	10-17
10.5	Approaching a vessel in need of towing	10-17
10.5.1	Before approaching the vessel	10-17
10.5.2	Towing approaches	10-17
10.5.3	Determining the towing approach to use	10-18
10.5.3.1	The parallel approach	10-19
10.5.3.2	Crossing-the-T approach	10-19
10.5.3.3	The 45-degree approach	10-20
10.5.3.4	The back-down approach	10-20
10.5.4	Passing the towline	10-21
10.5.4.1	General	10-21
10.5.4.2	Preparation and use of heaving line	10-21
10.5.4.3	Preparation and use of float line	10-22
10.5.4.4	Line throwing apparatus	10-22
10.5.5	Weighing anchor of a disabled craft	10-22
10.5.5.1	General	10-22
10.5.5.2	The shackle method	10-23
10.5.5.3	The kicker-hook method	10-24
10.5.5.4	The bowline method	10-24
10.5.6	Selection of the towline connecting point	10-24
10.5.6.1	Trailer eyebolt	10-24
10.5.6.2	Bow cleat, bow bitt or Sampson post	10-25
10.5.6.3	Method of connection	10-26
10.6	Use of bridles	10-26
10.6.1	Double-leg bridles	10-26
10.6.2	Single-leg bridles	10-27
10.7	Stern tow	10-28
10.7.1	Preliminary procedures	10-28
10.7.2	Procedures underway	10-28

10.8	Towing speed	10-29
10.8.1	General	10-29
10.8.2	Determining safe towing speed – displacement hull	10-30
10.8.3	Determining safe towing speed – planing hull	10-31
10.9	Towing alongside	10-31
10.9.1	General	10-31
10.9.2	Shortening the tow	10-32
10.9.3	Securing alongside	10-32
10.10	Entering a marina with a vessel in tow	10-33
10.11	Docking the alongside tow	10-34
10.12	Heavy weather towing	10-35
10.13	Towing in current	10-36
10.13.1	General	10-36
10.13.2	Towing upstream	10-36
10.13.3	Towing downstream	10-37
10.13.4	Towing across the current and/or from current to still water ..	10-37
10.14	Towing aircraft	10-37
10.14.1	General	10-37
10.14.2	Approach	10-37
10.14.3	Passing the line	10-38
10.14.4	Towing	10-38
10.14.5	Lights	10-38
10.15	Person overboard operations with a tow astern	10-38
10.15.1	General	10-38
10.15.2	Method	10-39

10.16 Tandem towing	10-40
10.16.1 Methods	10-40
10.16.1.1 Honolulu method	10-41
10.16.1.2 Daisy chain method	10-41
10.16.1.3 “Y” method	10-42
10.17 Sinking tow and a tow on fire	10-42
10.17.1 Passing the canister pump to a vessel in tow	10-42
10.17.2 Managing a sinking tow	10-43
10.17.3 Fire on a towed vessel	10-44
10.18 Towing precautions checklist	10-44

10 TOWING

10.1 GENERAL

As a crewmember on a vessel engaged in search and rescue operations, you will be called upon to tow many types of maritime craft. This chapter covers forces in towing, towing equipment, safety and procedures. You will need a firm grasp of towing principles to ensure that a “routine” evolution does not result in injury or further damage to property. No two towing processes are exactly the same : variations in technique and procedure will occur. Apply your knowledge of principles and standard procedures to take weather and sea conditions, vessel types and crew experience into account. Ensure that you and your vessel have the capability to complete the tow.

If you are a Coast Guard or Coast Guard Auxiliary SRU, you are bound by the regulations posted in the Canadian Coast Guard Towing Policy and/or the National Guidelines Respecting Coast Guard Auxiliary Activities. Be familiar with and comply with the policies, directions and information contained in these publications.

10.2 SAFETY

Safety is always the most important concern. Every towing process is potentially dangerous. The safety of your crew and of the crew of the towed vessel is more important than property, and your primary responsibility in any towing situation is to maintain safety measures. Towing is a complex operation. A safe and successful outcome hinges on crew professionalism, ability and teamwork.

10.2.1 Communications

Communications are a prime factor in achieving a safe and efficient tow. There is no room for assumptions. Communications with the disabled vessel and with your SAR crew are of utmost importance. The SRU must gather as much information as possible regarding the disabled vessel’s problem and condition. The disabled vessel must, in turn, know the exact intentions and expectations of the SRU.

10.3 FORCES IN TOWING

Vessels engaged in search and rescue operations must understand the forces and resistance that will act on the towed vessel and the means to handle these forces safely. These are the same forces that affect all vessels, but a distressed vessel is limited in its capacity to overcome them. The towing vessel must provide the means to move the towed vessel, and it must be understood that the towline will transfer all forces from the towed vessel to the towing vessel. Learn to recognize the different forces and each of their effects individually in order to effectively balance and overcome them when they act together.

10.3.1 Static forces

Static forces cause a towed vessel to resist motion. The mass of the vessel to be towed will determine its inertia (the tendency for a vessel at rest to stay at rest). The greater the inertia, the greater the force that will have to be applied to the vessel to get it moving. Overcome the effects of a vessel's inertia by starting a tow slowly. Never change the towed vessel's heading until the tow is up to speed.

10.3.2 Momentum

Once a vessel moves in a straight line, it wants to keep moving in a straight line. The greater its displacement or the faster it is moving, the harder it is to stop or change the vessel's direction.

10.3.3 Friction resistance

As a vessel moves, the layer of water in immediate contact with the hull moves. Due to friction between water molecules, the layers of water close to the hull try to drag along. As speed increases, the amount of drag increases, and more power will be required to maintain the towing speed.

10.3.4 Form drag

Form drag plays a large role in the capacity to control changes in the towed vessel's movement. The shape and the size of the hull can either help or hinder efforts to move in a straight line. A deep-draft, full-hulled vessel takes more effort to move (as it has to push more water out of the way) than one with a fine, shallow hull. It will be more difficult to alter course while towing a deep-draft, full-hulled vessel, but this type of hull will tend to steady up on a heading more easily than a fine, shallow hull.

10.3.5 Wave making resistance

A surface wave forms at the bow while the hull moves through the water. The size of the bow wave increases as speed increases, and this wave creates resistance to the bow's being pulled through the water. Towing vessels must be careful not to tow a vessel faster than the design speed of the hull.

10.3.6 Wave, spray and wind drag

These frictional forces act on the hull, topsides and superstructure. They all have a major effect on the motion of the towed vessel and the transfer of forces through the towline. These forces constantly change with both the vessel's motion and the environmental conditions, and could result in shock loading of the towline. Shock loading is the rapid, extreme increase in tension on the towline, which transfers through the towline to the tow fittings on both vessels.

10.3.6.1 Wave drag

Be aware that in large seas, wave drag could overcome the towed vessel's forward momentum and cause the towed vessel to stop and transfer a large amount of strain to the towline. This shock loading could result in damage to the tow fitting, the detachment of the towline and potential danger to both vessel crews.

Be aware that in head seas, the towing vessel can only counter the effects of wave drag by the speed and angle at which the towed vessel encounters the wave. Limit speed and tow at an angle to the seas to prevent waves from breaking over the bow of the towed vessel.

In following seas, be aware that wave drag causes the towed vessel to speed up as the crest of the wave approaches. Increase speed to keep tension on the towline, then decrease speed as the crest of the wave passes the towed vessel.

10.3.6.2 Spray drag

Wave spray could slow the towed vessel and increase the shock load. Spray could also adversely affect the towed vessel's stability through the accumulation of water on deck and the accumulation of ice formed by freezing spray.

10.3.6.3 Wind drag

Wind drag can cause shock loading and also have an adverse affect on the towed vessel's motion and stability. A steady beam wind can cause list and leeway, while a severe gust can cause a threatening heel. List, leeway and heel will most likely cause a towed vessel to yaw.

10.3.7 Combination of forces and shock loading

An SRU will rarely deal with only one force acting on the tow. The crew usually faces a combination of all forces, each making the situation more complex. Some individual forces are very large and relatively constant. Crews can usually deal with these forces safely, provided all towing force changes are made slowly and gradually. When forces are changing in an irregular manner, tension on the towline starts to vary instead of remaining steady. Given the potential dangers of shock loading, the tow vessel must use various techniques to prevent or counteract its effect.

The following table will outline the effects of altering towing techniques on the combination of forces and shock loading.

Action	Effect
Reduce towing speed	Slowing down lowers frictional resistance from drag and wave resistance. Reducing these forces will lower the total towline tension. In head seas, reducing speed also reduces wave drag, spray drag and wind drag, lowering irregular towline loads. The total reduction in forces on the tow can be rather substantial. When encountering another vessel's wake in relatively calm conditions, reduce speed early enough so that the towed vessel loses momentum before encountering the wake. Slamming into a large wake will shock load the towline of a small towed vessel, and may even swamp it.
Get the vessels "in step"	Extreme stress is placed on the towline in heavy weather when the tow vessel and the towing vessel do not climb, crest or descend waves together. Vessels in step will gain and lose momentum at the same time, allowing the towing force to gradually overcome the towed vessel's loss of momentum, minimizing shock loading. To get the vessels in step, lengthen the towline if possible.

Lengthen the towline	A longer towline reduces the effect of shock loading in two ways. The weight of the line causes a dip in the line called a catenary. The more line out, the greater the catenary. When tension increases, energy from shock loading is spent on “straightening out” the catenary before being transferred through the rest of the towline and fittings. The second benefit of a longer towline is more stretch length. Depending on the type of towline, another 50 ft. of towline will provide another 5 to 20 ft. more stretch as a shock load absorber. Remember to lengthen the towline enough to keep the vessels in step and minimize the shock load source.
Set a course to lessen the effects of the seas	Do not try to tow a vessel either directly into or directly down large seas. Tow on a course to keep the seas 30° to 45° either side of dead ahead or dead astern. This may require “tacking” to either side of the actual desired course.
Deploy a drogue from the towed vessel	A drogue may help to prevent the towed vessel from rapidly accelerating down the face of a wave. The drogue does not add form drag to the tow, but could prevent shock loading.
Constantly adjust towing speed to match that of the towed vessel	In large seas, constant adjustments to towing speed may reduce shock loading. The operator must observe the towed vessel constantly, and increase or decrease towing speeds to compensate for the effects of approaching or receding seas on the towed vessel. This process requires much practice and experience.

Note: Preventing shock loading and reducing its effects are crucial to safety. Shock loading presents a definite possibility of vessel fitting or towline failure. One of the most feared possibilities is towline “recoil.” Think of this as a greatly exaggerated version of stretching a rubber band until it breaks. Remember that some nylon cordage can stretch up to an additional 40% of its length before giving way.

Shock loading can also capsize or swamp the towed vessel. The additional towing force from a shock-loaded towline could cause a small vessel to climb its bow wave and become unstable. It could also pull the bow through a cresting wave.

10.4 TOWING EQUIPMENT

During towing operations, always use the proper equipment for the task. Using the proper equipment minimizes accidents and possible injury. Towing equipment may include towlines, pendants, bridles, deck fittings, hardware for attaching the towline (shackles, swivels, etc.) fenders, drogues, and lines for towing alongside. This section discusses the design, use and limitations of towing equipment.

10.4.1 Towlines

Towline length, type and size will depend on the towing vessel's construction, power, size and fittings. Vessels engaged in SAR should never carry less than 100 m (330 ft.) of towline, especially if the SAR unit is required to operate in heavy weather or offshore. Otherwise, the stress of surging on the towline will be transferred to the towline connection fittings. The proper towline should have a good combination of strength and elasticity and will allow a vessel to tow up to its design limits. Do not tow beyond the vessel's design limits by simply increasing towline size. If the towline's breaking strength exceeds the limits designed into the vessel's fittings and structure, damage and structural failure may result.

If possible, store towline on a reel with the bitter end secured with small lashings. This will help the towline to lie evenly on the reel and will allow for the quick slipping of the towline in an emergency by cutting the small lashings.

When putting a new towline in service, splice an eye at both ends. This will allow an "end-for-end" switch before part of the towline is beyond useful service. Safe and efficient towing requires an undamaged, serviceable towline. Whenever any towline damage is found or suspected, remove or repair the damage. If removing damage shortens the towline to less than serviceable length, replace the towline. Undamaged sections can be used for bridles, mooring lines, etc.

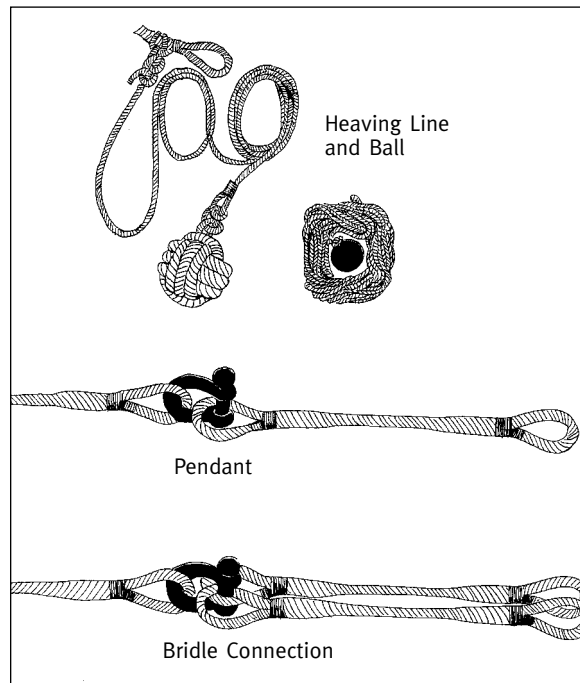

Figure 10.1: Towing Equipment

Inspect towlines on a regular basis to detect damage from:

- cuts;
- chafing;
- flattening;
- fusing (caused by overheating or over-stretching);
- hardening (heavy use will compact and harden a towline and reduce its breaking strength);
- snags; and
- deterioration due to exposure to salt water, petroleum and ultra-violet rays.

If a towline shows any of these characteristics, it should be taken out of service immediately.

10.4.2 Towline reel

The towline reel provides effective storage and availability for the towline. The towline should be secured to the towline reel with small lashings to allow the line to lie evenly on the reel. If it becomes necessary to slip the towline, the small lashing can easily be cut. A minimum of four turns should be kept on the towline reel at all times. Paying out the entire length can result in loss of the tow and towline in the event of a surge. The bearings on the towline reel should be kept clean and lubricated for proper performance.

10.4.3 Towing pendants and bridles

It is not always possible, appropriate, or safe to attach a towline from the stern of a towing vessel to a single point on the bow of a disabled vessel. The disabled vessel's deck layout may not have a suitable strong point, or deck fittings may be improperly mounted to the deck. In these cases, it may be necessary to rig a pendant or bridle. The pendant or bridle forms part of the towing arrangement, leading from the eye or thimble in the towline to the appropriate location(s) or deck fitting(s) on the towed vessel. Pendants and bridles are usually made from rope, wire or webbing straps.

When possible, use pendants or bridles with breaking strength equal to or greater than the towline. If the towed vessel's deck fittings limit the bridle or pennant size, consider doubling-up. When expected towing forces threaten the safe working load of the individual bridle legs, all doubled-up lengths must be exactly the same so that each part shares an equal load.

10.4.3.1 Pendant

Use a wire pendant to reduce wear and chafing at the towline end (particularly the eye and its splice). A pendant must be long enough so that the towline connection is clear of obstructions on the towed vessel.

10.4.3.2 Bridle

Use a “Y” bridle when both legs can be rigged to exert an equal pull on the hull of the disabled vessel. A bridle provides the best results when towed vessel deck fittings are not located right at the vessel’s bow or where bow obstructions would prevent the towline from leading directly back to the towing vessel. Use the following list as a guideline to attaching a bridle for towing:

- Use a long bridle when the best attachment points for the towed vessel are well aft to either side of the deck, but maintain a fair lead forward to reduce chafing;
- Consider using a wire bridle if excessive chafing is anticipated;
- Remember that the amount of tension on each bridle leg increases with the size of the angle between the bridle legs;
- Keep the legs of a bridle long enough so the angle of the legs stays under 30°;
- The legs must be long enough to reduce towed vessel yaw;
- Protect bridle with chafing gear as necessary;
- Use thimbles in the bridle leg eyes where the eyes meet;
- When the bridle is shackled to the towline, remember to mouse the shackle pin;
- Single-leg bridles are normally used to tow sailing vessels. If the mast is capable of withstanding towing stresses, the bridle is secured by taking one round turn around the base of the mast and securing the bridle to the towline with a shackle;
- Double-leg bridles are used in situations where they can be rigged so that both legs exert an equal pull on the hull. They are generally rigged to both bows of the towed vessel. No specific length is required, but the legs must be long enough to reduce the tendency to yaw. The breaking strength of the legs must be equal to or greater than the towline. The legs may have eyes spliced in the bitter ends or be left without eyes.

Note: Cabin and hull bridles are used if the towed vessel does not have adequate deck fittings. These bridles are NOT RECOMMENDED for use. They require a good deal of time to rig properly and require more line to construct than is normally carried aboard an SAR unit. The line’s waist and tag lines (lines used to secure the bridles in position) are subject to high stresses from static and dynamic towing forces. Furthermore, the way in which these lines are rigged makes towing control very difficult even in calm waters. There are many different methods of constructing these bridles, depending on the vessel being towed. It is impossible in this manual to recommend a SAFE procedure for constructing them. If the vessel does not have adequate deck fittings for towing, it may be prudent to remove the POB and advise the owner to seek commercial assistance.

Safe and efficient towing requires undamaged, serviceable pendants and bridles. Inspect pendant and bridles for damage on a regular basis. Ensure bridle leg lengths are equal. Wire ropes and bridles must be inspected for:

- broken wires;
- fish hooks (broken ends of wire that protrude from the lay);
- kinks;
- worn or corroded portions (worn portions of wire rope appear as shiny, flattened surfaces).

10.4.4 Messengers

A towline is too heavy to cast more than a few feet. In rough weather, or if it is impossible to get close enough to throw a towline to a disabled vessel, use a messenger to reach the other vessel. A messenger is a length of line used to carry a larger line or hawser between vessels.

10.4.5 Chafing gear

Chafing gear protects towlines, bridles and pendants from wear caused by rubbing against deck edges, gunwales, bulwarks, chocks or tow bars.

10.4.5.1 Preventing chafing damage

Tie layers of canvas or leather to the towline, bridle or wire rope at contact points to prevent chafing damage. Sections of old fire hose also work well as chafing gear. Make sure the chafing gear stays in place for the duration of the tow.

10.4.5.2 Thimbles

Thimbles are designed to equalize the load on an eye of a line and provide maximum chafing protection to the inner surface of the eye. On double braided nylon, use thimbles made specifically for synthetic lines. Use galvanized “teardrop”-shaped thimbles on wire rope.

10.4.6 Deck fittings and other fittings

Fittings are attachment or fair lead points on a vessel for towlines, anchor lines and mooring lines. Many fishing and sailing vessels have other attachment points for standing and running rigging that could also provide attachment points for towing. For towing, only use attachment points that are designed for horizontal loads.

Common fittings include bitts (mooring and towing), cleats, chocks, and Sampson posts. Do not overlook pad eyes, turning and snatch blocks, winch drums, capstans, and windlasses when considering attachment points. Trailer-able boats usually have an eyebolt or eye fitting at the bow for the attachment point.

10.4.6.1 Condition and inspection

Make regular inspection of towing vessel fittings. Check for cracks, fractures, rust, corrosion, wood rot, fibreglass core softening, or delamination. Inspect surfaces that are normally hidden from view, particularly backing plates and under deck fasteners. Tow bars are subject to high vibration and may loosen or cause stress fractures around their foundations. Keep working surfaces free from paint and relieve any surface roughness. A smooth working surface reduces wear, friction and chaffing on lines.

10.4.7 Kicker hook

The typical kicker hook has a quick-release safety buckle and snap hook clip that can be attached directly to a boat hook handle. Kicker-hook assemblies are commercially available.

Attach the kicker hook line to a towline with a shackle. Use the kicker-hook assembly to reach down and place the hook into the disabled vessel's trailer eye. The hook is snapped into the eye and the boat hook is slipped off the hook and pulled back.

10.4.8 Using a drogue

A drogue is a device that acts in the water somewhat the way a parachute works in the air. The drogue is deployed from the stern of the towed vessel to help control the disabled vessel's motion. You must familiarize yourself with the operating characteristics and effectiveness of drogues under differing conditions. The time to learn about a drogue is before you need to deploy one.

While trailing a drogue from the towed vessel is an acceptable practice, and may be useful when the disabled vessel has lost rudder control, normally it is not deployed well offshore. If necessary to tow a vessel with large swells directly on the stern, it may be more prudent to alter course or lengthen the towline rather than deploy a drogue. Drogues are typically used when the tow is shortened, for example in preparing to tow into a bar or inlet. With a short hawser and large swells on the stern, the drogue is deployed to prevent the towed vessel from running up on the stern of the towing vessel and to keep tension on the towline to help prevent the towed vessel from "surfing" down the face of a wave.

The idea of a drogue is to provide backward pull on the stern of the towed vessel so that the wave will flow under the boat. It is important to match the size of the drogue to the towed vessel, its deck fittings and overall condition. The larger, well-constructed cone drogues can exert a very large force on a boat's transom, so the towed vessel's stern must be carefully examined.

There are numerous types, sizes and styles of drogues commercially available. A traditional drogue is a canvas or synthetic cloth cone, with the pointed end open. Drogues of this type have a ring in the base of a cone (the leading edge) to which a four-leg bridle is attached. The other end of the bridle connects to a swivel, which in turn connects to a line made fast to the stern of the towed vessel. The towed vessel "tows" the drogue.

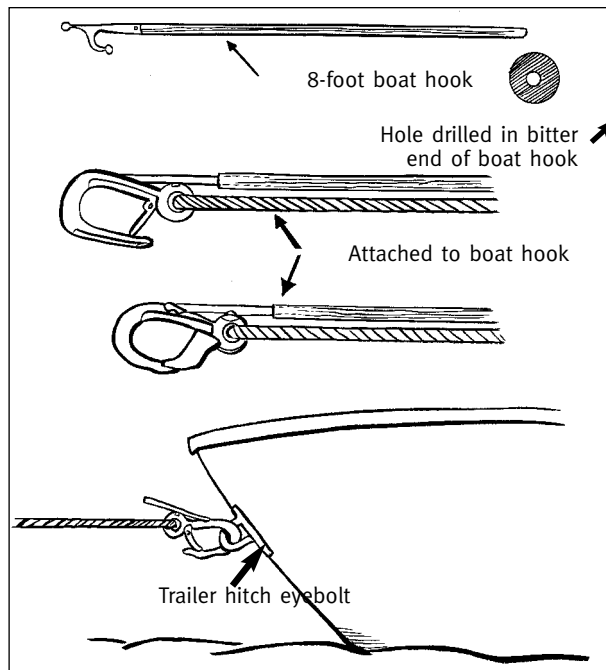

Figure 10.2: Towing with a kicker hook

10.4.8.1 Prepare the drogue gear

For the drogue towline, use approximately 60 m (200 ft.) of line that is marked every 15 m (50 ft.). It is important that the line have a sufficient safe working load to accommodate the load that will be applied by the drogue.

Transfer the drogue rig to the disabled vessel before taking it in tow. The following checklist will help ensure that the drogue rig and related equipment are ready for transfer.

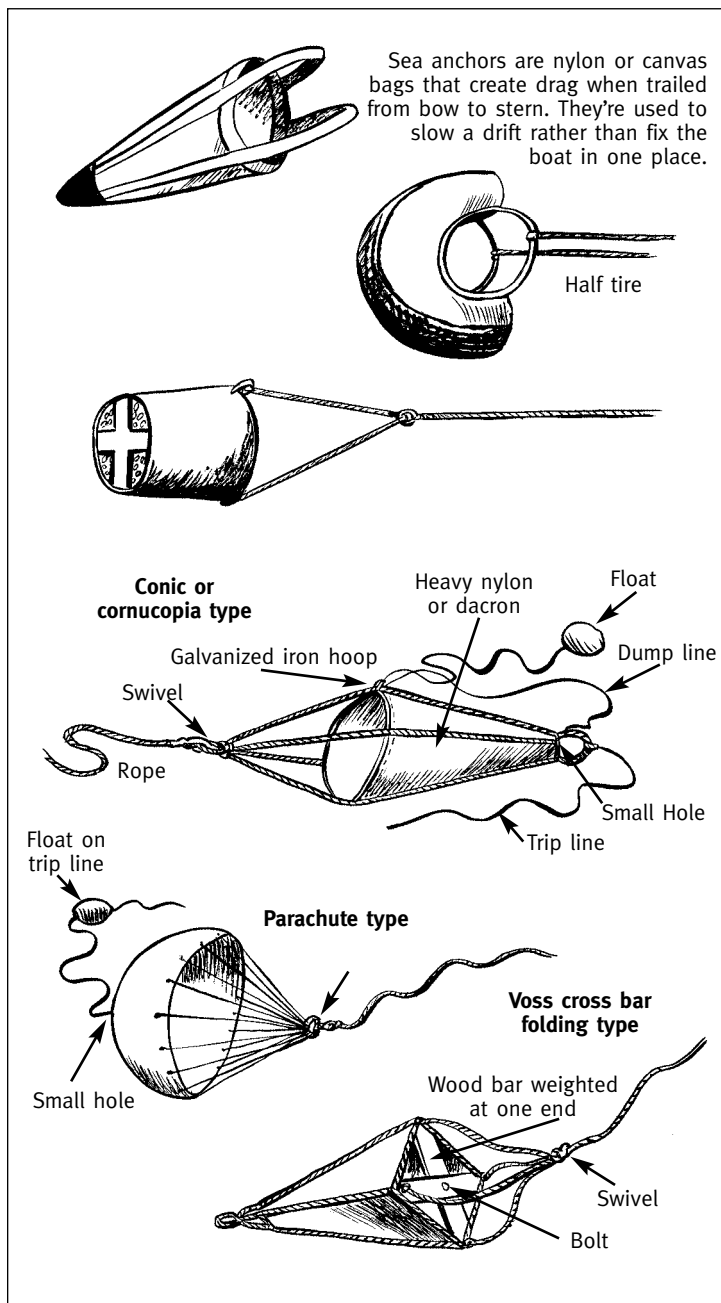

Figure 10.3: Drogue types

Checklist:

- Visually inspect the drogue rig for worn, rusted or corroded fittings and swivels, correct size shackles, and untangle bridles;
- Ensure that the drogue rig has 60 m (200 ft.) of appropriate SWL attached to the bridle swivel using a correct-sized shackle. Make sure it has no sharp fittings or exposed wires, and is stowed in a manner that will keep it intact until it is deployed;
- Provide all necessary drogue rig equipment such as extra shackles, bridles, straps, and chafing gear to achieve the best possible connection to the stern of the tow;
- Place all equipment into a gear bag with laminated written instructions (in both official languages) and illustrations on how to rig a drogue, both with and without a bridle. At night, attach a chemical light to the bag and include a flashlight inside;
- Attach floatation to the bag (usually a high-flier) and two lines, each 12 m (40 ft.) in length, to ease in the transfer of the drogue rig.

10.4.8.2 Pass the drogue

Pass the drogue from the best possible position directly from the towing vessel to the towed vessel. The drogue and line can be heavy and awkward for the crew of the disabled vessel. If possible, manoeuvre the rescue vessel to pass the drogue rig to an area on the disabled vessel that has low freeboard.

Instead of immediately taking the boat in tow, stand by and watch the disabled vessel's crew rig the drogue for deployment. Provide direction and clarification if necessary.

10.4.8.3 Rig drogue for deployment

Use securing points as near to the centreline as possible. On many vessels, a bridle will be needed to spread the load between two separate fittings to centre the drogue towline. Winches, motor mounts, masts and davit bases are other possible locations for good strong connections. When trying to compensate for a jammed rudder, attach the drogue well off the centreline, close to the quarter, opposite the side where the rudder is jammed.

10.4.8.4 Deploy the drogue

Start the tow moving, then direct the disabled vessel to deploy the drogue. Move the tow forward slowly, just enough to control the tow, then direct the disabled vessel's crew to recheck connections.

Put the drogue in the water and pay out the line slowly for a safe position. Unless circumstances dictate otherwise, pay out all 60 m (200 ft.) of drogue line.

Once the drogue sets and starts to pull, slowly increase speed while observing the rig. Check attachment points and the effectiveness of the drogue. If adjustments must be made, slow down to make them.

Once you deploy a drogue, pick the most comfortable course and speed. Control of the tow is more important than speed. Towing a drogue at too great a speed may damage the towed vessel or cause the drogue rig to fail. The drogue rig should be monitored at all times during the tow.

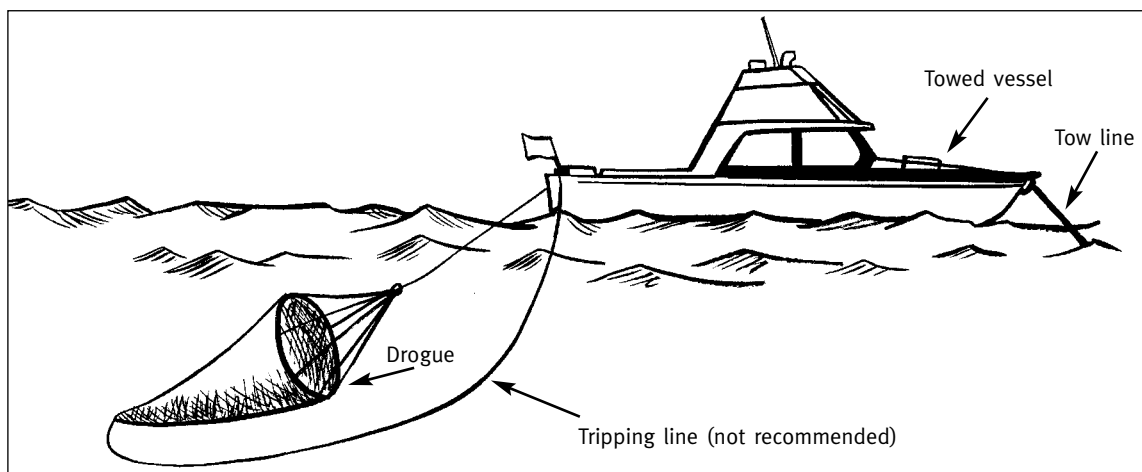

Figure 10.4: Towing with a drogue

10.4.8.5 Shortening up and recovering the drogue

A tripping line is not recommended, but several alternate methods are available. If recovery is not properly set up and controlled, a drogue may become fouled in the tow, the rudder or propeller, or other object.

Slow or stop the tow and have the crew of the disabled vessel pull in the drogue. If necessary, bring the tow around or alter course to relieve all tension on the drogue during recovery.

It may be necessary to attach a dumping line, a short piece of line (of different colour) run from the bridle shackle to the tail of the drogue, outside the cone. Haul the drogue to the stern, recover the dumping line, and pull it to invert the drogue and make it easy to recover. A dumping line is only suitable for large drogues that drain slowly.

10.5 APPROACHING A VESSEL IN NEED OF TOWING

10.5.1 Before approaching the vessel

Effective communication sets the stage for safe towing operations. Before arrival on scene, the commanding officer/coxswain should have established communication with the disabled vessel and determined the nature of the disabling problem. The disabled vessel should be made aware of your ETA and intentions on arrival. The SAR crew should be briefed on what equipment is to be prepared for arrival on scene and on the signal and procedures for the release of the tow under emergency conditions.

Before taking a vessel in tow, the coxswain must fully brief all crewmembers on the intended procedures to be applied in the particular case. Of specific significance in a briefing are the following:

- type of approach;
- when and from which side to transfer the towline;
- how to transfer the towline (with or without a messenger);
- how much towline is to initially be paid out; and
- any particular safety concerns that the case may warrant.

In most situations, the coxswain will make one complete circle around the disabled vessel, inspecting it as closely as possible. Before starting the approach, the coxswain should ensure that all crewmembers are prepared for their tasks, and that personnel on the disabled vessel are ready to receive the towline and understand what is expected of them in attaching the towline. (This procedure may be conducted by SAR crew if conditions allow, and if the coxswain chooses to place a crewmember aboard the disabled craft.)

10.5.2 Towing approaches

The approach chosen by a coxswain will be based on his or her assessment of the situation with regard to the prevailing weather conditions and the nature of distress. This will be a discretionary decision that must be left to the coxswain. However, a coxswain must be capable of carrying out all approach types, as incidents will occur where only one approach is appropriate.

10.5.3 Determining the towing approach to use

The chosen approach depends on several factors, including the following:

- the size and type of the disabled vessel;
- the manoeuvring characteristics of the SAR vessel;
- the position of the casualty relative to nearby hazards and both vessels' attitude to wind and sea; and
- the rate at which the vessels are drifting.

The casualty will generally be lying in one of four generally stated conditions:

- beam to the wind;
- oblique to the wind;
- head to the wind; or
- stern to the wind.

Different vessels will take up widely differing angles of rest when allowed to drift freely in a seaway. Factors affecting this angle are:

- vessel size and type;
- hull form;
- lading;
- ballast;
- trim; and
- underwater appendages.

The angle of rest will determine the motion of the vessel in a seaway. In simplest terms, this may range from a pure roll in the case of a vessel lying with her beam to the elements, to a true pitching motion in the case of a vessel lying with her bow or stern to the wind and seas. When a vessel lies at broad angles to the weather, the required action is more complex. In this case, the bow and stern yaw considerably as the sea action affects the hull form before and after the midships section.

The vessel's angle of rest will determine the rate of lee drift. The aspect of the vessel presented to the wind will determine the total wind pressure on the vessel and affect the rate of drift.

The coxswain will assess the factors and designate the most advantageous position from which to transfer and connect the towline. The rate of drift is determined by manoeuvring your vessel onto the same heading as that of the disabled vessel and stopping astern of it. If the distressed vessel begins to drift away, its rate of drift is faster than your vessel's. Use caution when approaching leeward of a vessel that you intend to take in tow or bring alongside. The disabled vessel may block the wind, particularly if the boat is larger than yours and has high cabins. The wind force affects each vessel differently: it is greatly reduced on your vessel. The disabled craft will drift toward you quite rapidly. BE ALERT for this sudden change-of-wind effect as you make your approach, and be ready to manoeuvre as necessary.

WARNING

Should this loss-of-wind factor not be taken into consideration in determining your towing approach, collision severe enough to seriously damage both vessels may result.

10.5.3.1 The parallel approach

The parallel approach is used in good weather conditions when the casualty's rate of drift is slow. The SAR vessel will approach from the stern on the windward side of the casualty. The SAR vessel comes close enough to pass the towline and stops a safe distance ahead of the casualty while the connection is made.

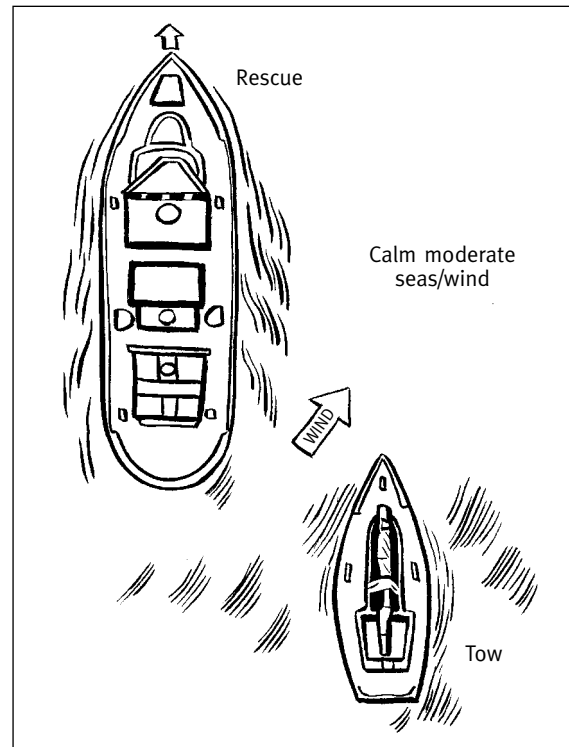

Figure 10.5:
The parallel approach

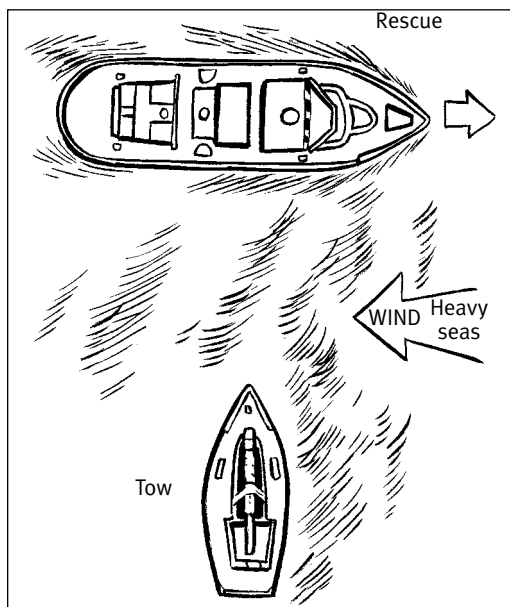

Figure 10.6:
Crossing-the-T approach

10.5.3.2 Crossing-the-T approach

If a heavy sea is present or the casualty's rate of drift is brisk, the crossing-the-T approach is used. The SAR vessel crosses the bow of the casualty on a heading perpendicular to it, heading into the sea or wind if possible. The towline is passed just before the towing boat passes the bow of the casualty.

10.5.3.3 The 45-degree approach

If sea conditions are calm to moderate, the 45° approach may be used. The SAR vessel will approach on a heading about 45 degrees from the casualty's bow. The towline is passed just before the SAR vessel's bow crosses the casualty's.

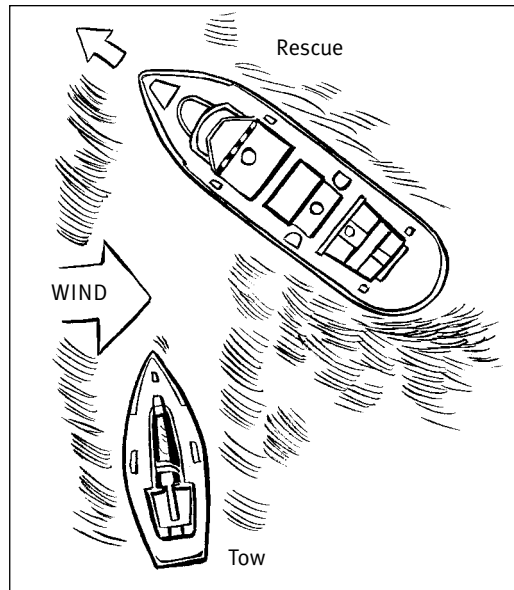
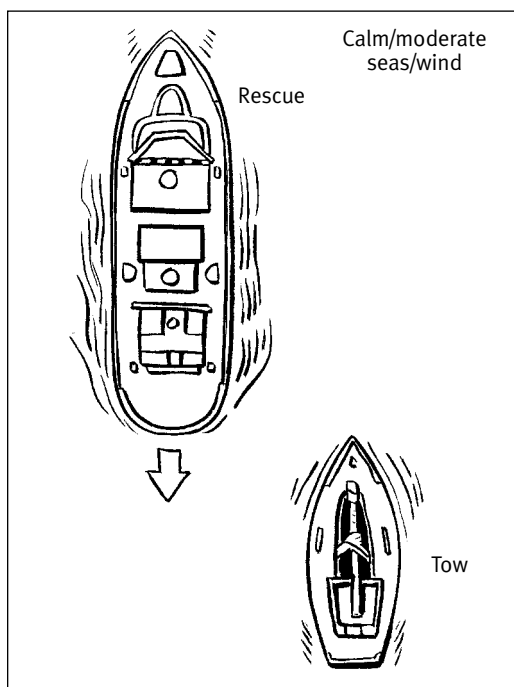

Figure 10.7:
The 45-degree approach



10.5.3.4 The back-down approach

The back-down approach is similar to backing into a berth. The SAR vessel backs down to the bow of the casualty, passes the towline and moves a safe distance ahead to complete the connection. This approach does not offer the coxswain a clear view of what is going on with the towline. There is increased danger of picking up the towline in the screws.

Figure 10.8:
The back-down approach

10.5.3.5 Choosing an approach

The above approaches cover the spectrum of basic open-water approaches. The coxswain may have to use a variation on one approach to meet a particular set of circumstances. The key to success is familiarity with your vessel's manoeuvring characteristics and the knowledge and ability to carry out the basics. This knowledge and ability is best gained through towing experience or regular practice exercises under controlled conditions.

10.5.4 Passing the towline

10.5.4.1 General

In calm conditions, the SAR vessel may manoeuvre close to the casualty and pass the towline directly to the casualty. The length of line paid out should be sufficient to allow the casualty to handle it without being pulled by the SAR vessel. However, excessive lengths of line should not be passed for the connection in order to avoid the fouling of your propellers or jets. Deck crews must be particularly alert to line handling during this phase. Line should be controlled and paid out directly from the towline reel.

When conditions do not favor approaching close enough to pass the line directly, a messenger line must be used. The heaving line with a monkey fist at the throwing end is the simplest and most common method of sending a messenger. It should be used whenever practical.

Note: Never use a hard object to weight the line. Injury could result if this hard object hit someone.

10.5.4.2 Preparation and use of heaving line

- Wetting the heaving line will cause it to become more pliant and less likely to tangle;
- Bend the heaving line onto the towline, using a bowline or a clove hitch with two half hitches;
- Coil the line in the casting hand with the monkey fist hanging at the outside turn of the coil and below the same turn;
- Take two-thirds of the coil in the right or casting hand, and let the rest lie loosely in the left or other hand;
- Warn personnel aboard the casualty to be prepared to receive the heaving line;
- Cast the heaving line using a sweeping side-arm movement (this is the preferred method), keeping the casting arm straight and using your body;
- The line should not be tossed directly at the casualty or personnel on it. It should be thrown so that it falls across the deck of the vessel or catches the rigging and slides down to the deck.

Note: Preparing two heaving lines (bent to the towline) for passing a line is highly recommended. If the first pass is unsuccessful, the second line can be tossed immediately by a second crewmember. This will allow the connection to be made without the coxswain having to manoeuvre the SAR vessel back into position.

- The personnel aboard the casualty will pull the heaving line and towline aboard to make the towing connection. Be sure to allow enough slack to permit this without pulling the line from the hands of the receivers. (Usually they don't want to let go!)

10.5.4.3 Preparation and use of float line

The float line may be particularly useful in situations where a line cannot be passed by a heaving line.

- Select a suitable float to bend to the messenger (e.g., life ring, fender, scotchman, life jacket). Bend a messenger line of sufficient length to float to the casualty;
- Position the SAR vessel up-current from the casualty, and pay out the line until the float nears the casualty;
- With the line secured to the SAR vessel, run down current, passing the casualty so that the float will cause the messenger line to contact the casualty.

10.5.4.4 Line throwing apparatus

Preparation and use of line-throwing appliances

There are two categories of line-throwing appliances. A Type 1 appliance must be capable of carrying a line not less than 228 m (708 ft.) in calm weather. A Type 2 appliance shall be capable of carrying a line not less than 182 m (600 ft.) in calm weather. Both types must include four projectiles and four lines of suitable length as well as a watertight case for the lot. The projectiles, cartridges, or other means of ignition are limited to four year's service life from the date of manufacturing;

Small Coast Guard SAR vessels carry a variety of different models of line-throwing appliances (speedline, shoulder line gun and E-Z liner, etc.). The correct stowage, maintenance, and operation of these appliances are extremely important. Remember that line-throwing appliances are very powerful and should always be treated as firearms. Always follow the manufacturer's recommended procedures for stowage, maintenance and operation;

SAR crews must be fully familiar with the recommended operation of their particular equipment. ALWAYS FOLLOW THE MANUFACTURER'S OPERATING SPECIFICATIONS. Crosswinds will carry the bight of the line to leeward, causing the rocket projectile to turn into the wind. The rocket may pass over the target, but the line may fall to leeward. Be prepared for a second shot.

10.5.5 Weighing anchor of a disabled craft

10.5.5.1 General

At times, during an SAR incident, SAR vessels encounter a disabled craft that cannot pull its own anchor, either because it is physically too heavy to pull without power, or because the anchor is imbedded in the sea bottom and cannot be freed by hand.

In some cases, the coxswain may determine it prudent to advise the vessel operator to buoy and release his or her anchor line for later retrieval. However, if the anchor is to be pulled aboard the disabled craft before towing, there are three methods for accomplishing this from a small SAR vessel. These methods use either a shackle, bowline or towing assist hook (kicker hook) and are described below.

Consult the vessel operator to determine whether there are any obstructions or appendages on the disabled vessel that you should be aware of. Brief the operator on your intentions. Approach the vessel from a direction astern and parallel to the vessel, as if you are coming alongside.

10.5.5.2 The shackle method

This method works well, especially when a big, heavy shackle is used. To weight the anchor of a vessel by the shackle method, follow these guidelines:

- Secure an appropriate-sized shackle (screw-pin type) into the eye of the towline;
- Pass your towline to the vessel with the shackle secured in the eye;
- Instruct the operator of the disabled vessel to secure the shackle and towline to his or her anchor line by securing the shackle out board of all rigging and rails so that it may travel freely on the disabled vessel's anchor line;
- Obtain an estimate of the anchor line paid out from the vessel operator;
- Move ahead slowly while paying out a length of towline equal to the length of the anchor rod (ensure that the shackle has reached its destination before securing the towline);
- Secure your towline when this line is out;
- Move slowly ahead. As you move ahead, the shackle will slide down the anchor line of the disabled vessel. The shackle must slide all the way to the anchor. At this point, you have the other vessel in tow, with both the anchor line and your towline serving as the towline. Continue moving slowly ahead until the disabled vessel's anchor reaches the shackle. The shackle may slide up the stock of the anchor, particularly with lightweight anchors, causing the towline to jerk. This situation should not cause a problem. The towline will be secure for towing in this position;
- Slowly tow the disabled vessel free of danger. Once you are out of the danger zone, stop your vessel and instruct the operator to pull in his or her freed anchor. This procedure should be conducted as soon as safety permits, because you will not know the breaking strength or condition of the disabled vessel's line. Take care not to begin shortening up in shallower water, or the disabled vessel may become anchored again. This situation is to be avoided, as you would have no control over the disabled vessel and it may become grounded in the process;
- After the anchor line is hauled aboard the disabled vessel, secure the towline in the normal manner and commence your tow.

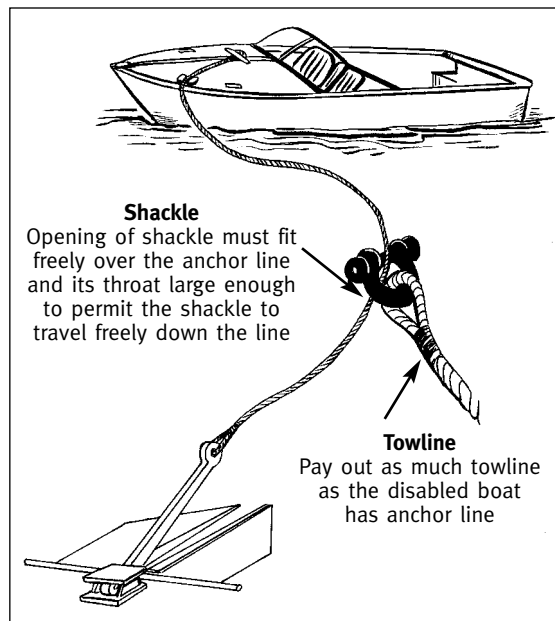

Figure 10.9: Weighing a disabled boat's anchor, using a shackle

10.5.5.3 The kicker-hook method

The kicker-hook method is an alternative to the shackle method. It is especially useful when it is impossible to manoeuvre easily around the casualty's anchor line. Proceed as follows:

- Using a bowline or double becket bend, secure the bitter end of the towing assist hook line to your towline;
- Come alongside the disabled vessel's anchor line and secure the towing assist hook to the anchor line by holding the handle and placing the hook as you would when securing to a trailer eyebolt;
- At this point, proceed as if you were using a shackle (see previous guidelines).

10.5.5.4 The bowline method

This method is the last resort, as it is less efficient than the ones described above. Here is how to proceed:

- Attach a suitably sized mooring line to your towline with a shackle, bowline or double becket bend;
- Pass the bitter end of the mooring line to the operator of the disabled vessel and instruct him or her to secure the bitter end around the anchor line (clear of all obstructions) with a bowline large enough to travel down the anchor line;
- Again, at this point, proceed as if you were using a shackle (see previous methods).

CAUTION

Check to determine whether the line needs to be weighted. Also check to prevent the bowline from being cut by the anchor "line."

10.5.6 Selection of the towline connecting point

The selection of suitable connecting points on the casualty must be made with care. Some vessels have very poorly secured cleats or attachment points that will not withstand towing stresses. Consultation with the master of the casualty is recommended, but consider that this operator may often have a jaded opinion of the quality of his or her vessel, including the strength of the fittings. Visual inspection, if possible, is highly recommended.

10.5.6.1 Trailer eyebolt

WARNING

Securing the towline to the trailer eyebolt can be hazardous to the SAR crew and the persons on the disabled craft because of the low attachment point and the requirement to position the two vessels close together. Exercise extreme care to protect the crewmember from being struck by the vessels.

The trailer eyebolt is generally a strong securing point at the stem and close to the waterline on smaller pleasure craft. It is designed to withstand the force of twice the weight of the craft. However, SAR crews are cautioned that, on older craft, foreign craft, damaged craft, altered or home-built craft, eyebolts may have much less than adequate strength. A visual inspection by the SAR crew is highly recommended. Another consideration in

towing by the trailer eyebolt is that its restricted size may not allow attachment of a shackle or hook with an SWL equal to or greater than that of the towline. A compromise of the largest size that will fit is often required. Before deciding to tow by the trailer eyebolt, the coxswain must consider all of these factors as well as the load on the casualty and the sea conditions.

The towing assist or kicker hook is an effective method of attaching the towline to the trailer eyebolt, and reduces the chances of injury to all personnel. Kicker hooks employed must be stamped and inspected with a breaking strength greater than the breaking strength of the attached towline. A shackle may also be used to secure a towline to a trailer eyebolt. This manoeuvre requires a crewmember to lean over between the vessels to attach the shackle, and should only be considered in calm to moderate sea conditions. As with the kicker hook, the shackle selected must fit the eyebolt, but also be of a breaking strength greater than that of the towline that it is attached to. The shackle pin must be moused with a wire or tie-wrap before commencing the tow.

10.5.6.2 Bow cleat, bow bitt or Sampson post

The bow cleat, bow bitt and Sampson post are common deck fittings on the bow of many vessels. Before securing the towline, make sure that cleats are secured to the deck with throughbolts and backing plates. Check to ensure that Sampson posts and bitts are secured to the deck at the keel and braced at deck level. If they are not, there is a potential of failure under the strain of towing. If there is concern over the strength of these fittings, the master of the casualty should be informed and, if the case dictates, the SAR crew should continue with appropriate care.

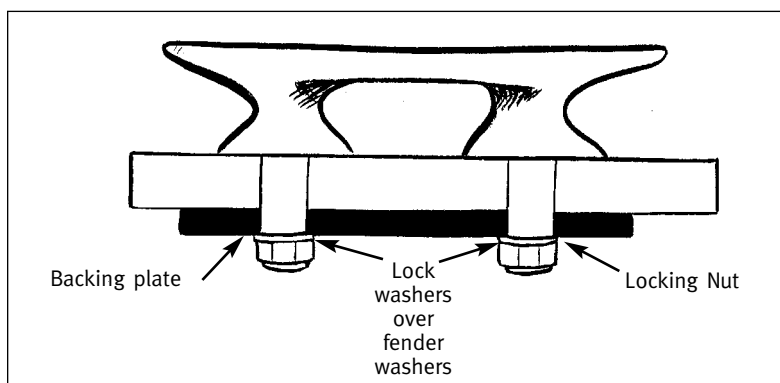

Figure 10.10: Back up plate

Note: If there is ANY doubt about the strength of the boat's fittings or the vessel operator's capability of making proper towline connections, it would be PRUDENT to place a crewmember on the disabled vessel for the purpose of visually inspecting the fittings and making the towline connection. If deck cleats are to be used for attaching the towline, make sure that the cleats and the towline are of compatible size. A towline whose diameter is too large for a cleat will apply unnecessary stress to the cleat's arms and may break them.

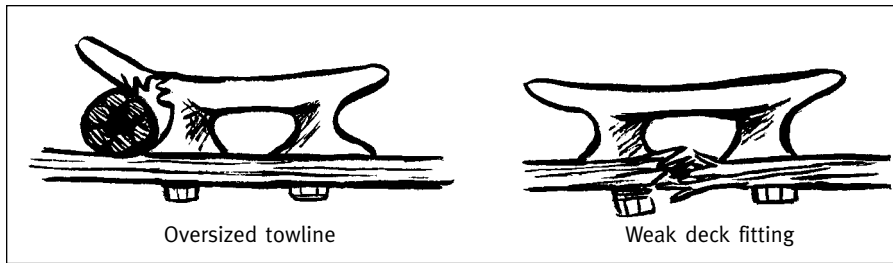

Figure 10.11:
Oversized
towline and
weak deck fitting

10.5.6.3 Method of connection

- If possible, delegate a crewmember to board the casualty to check the overall condition and suitability of the deck fitting to be used. If a crewmember is not boarding, discuss the condition and suitability of fittings with the master;
- Transfer your towline to the distressed vessel. Always use your own towline;
- If your crewmember is aboard, he or she will place the eye of the towline over the deck fitting and wind it under the fitting horns;
- The crewmember on the casualty will pull the towline snug up against the base of the fitting (where the eye splice begins), twist the eye of the towline to the left or right, thus forming a bight, and finally, drop the bight over the top of the deck fitting and under the horns.

Note: If the towline connection is made by personnel other than a crewmember placed on the casualty, ensure that the towline is properly secured to the appropriate fittings on the distressed boat. You may have to demonstrate the correct way to make the towline attachment.

10.6 USE OF BRIDLES

10.6.1 Double-leg bridles

Double-leg bridles, when properly fitted, equally distribute the pulling force on the casualty's deck fittings. They are attached to the two forward cleats, bitts, or Sampson post of the casualty. Long bridle legs will decrease the angle formed by the towing bridle and reduce strain on the casualty's deck fittings and on the towline.

Follow these guidelines when using double-leg bridles:

- If possible, assign a crewmember to board the casualty and perform the connection;
- Pass the towline and bridle to the casualty;
- The crewmember will secure the bridle legs to the designated deck fittings on the distressed boat, so that the stress during towing is equally distributed on the deck fittings. Be sure to allow for long bridle legs and a narrow angle to the towline;

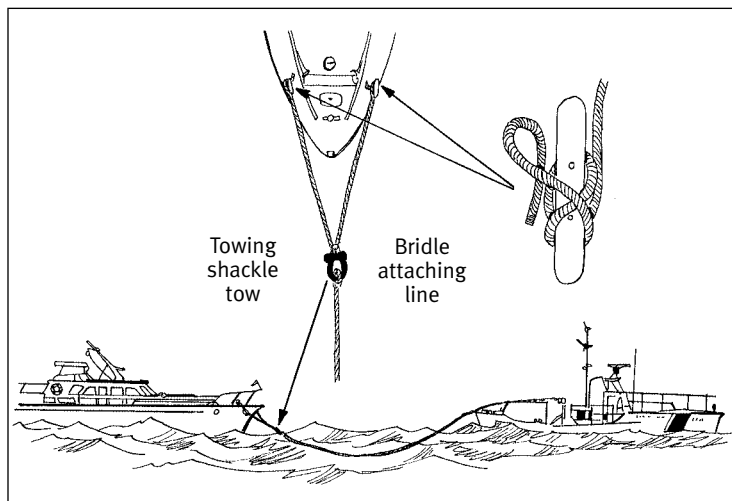

Figure 10.12a: Using double-leg bridles

- If a crewmember cannot be placed on the disabled vessel, ensure that the towline is properly secured to the appropriate fittings on the distressed boat. You may have to advise the casualty's occupants of the procedures for making the towline attachment;
- Be certain that the bridle legs are of equal length and that the shackle connecting the bridle to the towline is in line with the centreline of the casualty.

10.6.2 Single-leg bridles

Single-leg bridles are generally used only in towing sailing vessels, and are secured to the base of the sailing vessel's mast. The mast must be designed to deal with the stress of towing. This information must be obtained from the operator of the sailing vessel (ensure that the vessel is keel-slipped).

CAUTION

In all instances, the attachment point of single-leg bridles should be aft of the casualty's bow and fairlead through a point forward (bow chocks) to be in line with the boat's centreline. Ensure that the shackle connecting the bridle to the towline is also in line with the centreline of the towed vessel.

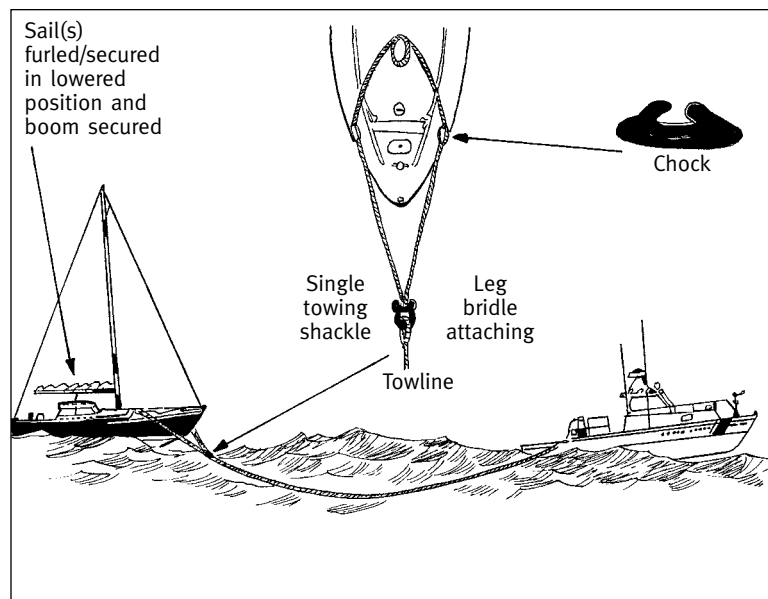

Figure 10.12b:
Using single-leg bridles

Proceed as follows when using single-leg bridles:

- Request information from the sailing vessel operator concerning the condition of the mast and the amount of tension it can withstand;
- Assign a crewmember to board the sailing vessel and perform the task;
- The crewmember will visually inspect the mast to ensure it can withstand the stress of towing;
- The crewmember will advise the coxswain of the results of the visual inspection. If the mast is found to be unsafe, the procedure must be halted;
- Pass the towline and bridle from the SAR vessel to the sailing vessel;
- The crewmember will take one round turn with the bridle leg around the base of the sailing vessel's mast and fairlead it forward through the chocks, if available;
- The crewmember will then secure the towline to the bridle with a bowline or shackle, ensuring that the shackle is in line with the boat's centreline, if used. For particularly heavy or long tows, additional stress may be transferred to the sailing winches aft by rigging additional lines from the towline attachment to the sailing winches. Strain is taken on the winches to reduce towing forces on the mast;

- If the towline connection is made by personnel other than a crewmember placed on the disabled vessel, ensure that the towline is properly secured to the appropriate fittings on the distressed boat. You may have to demonstrate the correct way to make the towline attachment.

10.7 STERN TOW

10.7.1 Preliminary procedures

Most SAR incidents involving towing will require you to take disabled vessels in tow astern. This is considered the safest method employed in open-water situations.

Before getting underway with the tow, do the following:

- Establish communication procedures and schedules with the casualty for the duration of the tow. Discuss emergency breakaway procedures. Ensure that a means of cutting the towline is in a ready position;
- When towing some vessels with hydraulic reverse gears, damage may occur if the freewheeling propeller causes the shaft and reverse gears to rotate without sufficient lubrication for the gears. It is advisable to have the operator secure the shaft by means of a shaft brake or by mechanically stopping it off with a pipe wrench. Line can also be used to tie off some shaft couplings;
- Explain to the operator of the disabled vessel that he or she will have to steer the vessel during towing. Discuss the appropriate towing speed with the operator;
- Ensure that both the SAR vessel and the casualty are displaying the proper lights or shapes, and that in restricted visibility they have changed to the proper sound signals. The SAR vessel will often have to advise the casualty on the proper signals, lights, or shapes. As the towing vessel, you are responsible for the safety of the tow;
- Advise the RCC/MRSC of the situation and your intentions. Advise the vessel traffic centre of intended route, description of tow, etc.

10.7.2 Procedures underway

Increase speed slowly, and make any required course alterations once both vessels are moving. Course alterations should be made slowly, and the towed vessel should be advised to steer on your stern;

Pay out enough towline to keep a dip or catenary in the line at towing speed. The catenary provides a shock absorber in the towline to prevent sudden changes in forces between the two vessels from putting undue strain on the towline and the vessels' fittings.

Keep the towed vessel in step. The towed vessel must be in the same position as your vessel relative to the sea/swell patterns so that your boat and the towed boat ride over the seas meeting the wave/swell crests at the same time. If one vessel is in a trough while the other is on a crest, the towline will become slack and then taut as the attitude of the vessels interchanges. The towline snapping tight is termed "jumping the line". This action can be forceful enough to break the towline or tear out deck fittings. In the situation where the SAR vessel rides up a face while the towed vessel slides down the back of a wave or swell, the towline will become slack. At this time there will be no control of the towed vessel. To correct an out-of-step situation, let out more towline or alter course to meet the seas diagonally.

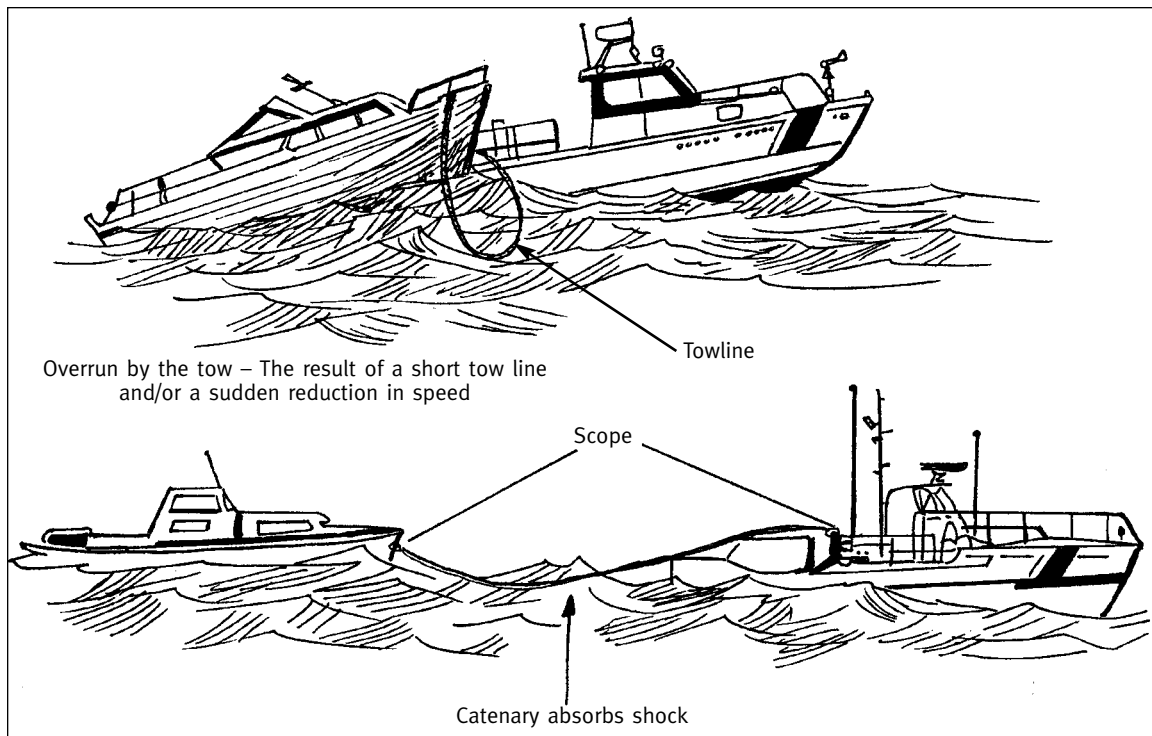

Figure 10.13: Keeping a catenary in the towline

Some towed vessels have a tendency to veer or yaw to one side or the other of your vessel relative to the towline and heading. Yawing is extremely dangerous and must be corrected or reduced as much as possible. Yawing can put excess strain on deck fittings and attached structures, causing damage or failure. Extreme yawing can capsize vessels. Corrective action may include one or more of the following:

- decreasing the towing speed;
- letting out or shortening the length of the towline;
- adjusting the trim of the tow, such that it is trimmed slightly by the stern;
- towing a drogue from the disabled vessel's stern;
- Post a towing lookout to continuously monitor the tow and immediately report any unusual situations to the coxswain.

10.8 TOWING SPEED

10.8.1 General

The primary consideration in determining towing speed is the safety of the casualty and its occupants. Towing too fast can at minimum damage property and at the extreme sink the vessel, with potential loss of life. Several factors must be considered in determining a safe towing speed. However, if ever in doubt, SLOW DOWN. Factors in determining safe speed include:

- hull type;
- waterline length;
- condition of vessel and its fittings;
- load and trim of casualty;
- limitations of the towing vessel;
- weather conditions;
- current or tidal conditions;
- location, traffic-density, etc.

10.8.2 Determining safe towing speed – displacement hull

A displacement-hulled vessel's maximum speed is determined by its waterline length in feet ($S = 1.34\sqrt{WLL}$). When the vessel is under its own power, it cannot physically exceed this speed. Additional power will not increase speed, but will be transferred to the hull of the vessel and can seriously damage it. This speed may also be referred to as design or critical speed. A thorough discussion on theoretical hull speed is presented in Chapter 9 (Boat Handling). The same principles apply whether the force propelling a displacement hull is a pushing or pulling force. If a displacement-hulled vessel is in tow, the engine(s) propelling the towing vessel becomes a "pulling force" propelling the tow. Coast Guard small-boat hulls are **not** displacement hulls and can safely be propelled at speeds in excess of that of a displacement-hulled craft of similar size. Therefore, you must be careful when taking a displacement hull in tow not to tow it beyond its **design** or **maximum towing** speed.

The following table demonstrates several waterline lengths for displacement-hulled vessels and their **approximate** design or **maximum** towing speeds, whether the propelling force is a pushing or pulling force. **speed** is expressed in the nearest tenth of a knot. **Remember**, towline size and a hull's design speed are **not** the only factors to be considered in determining towing speed.

Table 10.1: Maximum towing speeds

Vessel's Waterline Length	Square Root	Maximum Towing Speed
20	4,5	6,0
25	5,0	6,7
30	5,5	7,3
35	5,9	7,9
40	6,3	8,5
45	6,7	9,0
50	7,1	9,5
60	7,7	10,4
70	8,4	11,2
80	8,9	12,0
90	9,5	12,7
100	10,0	13,4
110	10,5	14,1

Note: Safety of life is of the highest priority in SAR incidents and takes precedence over a speedy return to base. High-speed towing is never recommended.

WARNING

DO NOT tow displacement hulls faster than their design or maximum speed. ANY attempt to increase this speed may cause the vessel to ride up on its bow wave and become unstable. Tension on the towline and towing hardware becomes enormous. You may also pull this hull under if you exceed the design or maximum speed. In following seas, a small boat

with an open stern is in danger of being flooded by a breaking wave if the towing speed is too slow.

A table of maximum towing speeds appears above. To use a safer towing speed, subtract at least 10% to the maximum towing speed values. Towing at this safe speed reduces frictional resistance and increases stability and safe control of the towed vessel.

Notes:

- *ALWAYS take into consideration the additional factors listed above when determining both maximum and safe towing speeds. Maximum towing speed should NOT be assumed unless ideal conditions exist. On the other hand, minimal towing speed should be maintained to avoid the tow's surfing before a wave or being overtaken by a breaker;*
- *An easier way to determine a safe towing speed is to ask to the master of the disabled vessel the maximum speed that can be attained with his or her boat. When towing, ensure that you do not exceed that speed.*

10.8.3 Determining safe towing speed – planing hull

The planing hull naturally allows a faster towing speed. The limiting factors are primarily your boat's weight and engine power and the weight of the vessel being towed. If the towing attachment point (e.g., trailer eyebolt) is low and close to the centreline, the planing hull can readily be placed in the planing mode, permitting a greater towing speed. Towing is POTENTIALLY dangerous if compounded by poor weather conditions, poor sea conditions and many unknown factors of the vessel being assisted, such as structural conditions, strength of deck fittings and stresses being placed on these fittings. Every effort must be made to ensure the SAFETY of LIFE and PROPERTY in ALL instances. Although higher towing speeds are obtainable with planing hulls, RECOMMENDED towing speeds for displacement-hulled vessels apply to planing hulls as well.

10.9 TOWING ALONGSIDE

10.9.1 General

Towing alongside is generally practiced in protected waters to gain maximum manoeuvring control over the towed vessel. This control is gained by securing the two vessels together so as to enable them to function as one vessel.

When preparing for the alongside tow, consider the following:

- brief your crew;
- follow safe procedures;
- break out the lines and fenders;
- rig fenders on the side that you intend to take the vessel alongside;
- keep lines clear of the water and particularly your propellers.

Fenders are employed to prevent damage to both vessels. They should be carefully placed to have the maximum effect. Remember: the forces acting between the two vessels will be quite intense. Compare the profile of the two hulls, and place fenders where they will cushion the areas of contact before coming alongside. It is good practice to retain at least

one fender to be tended by hand as required when coming alongside. After coming alongside, you may have to reposition fenders to provide the greatest protection.

10.9.2 Shortening the tow

Very often, vessels are initially towed astern. When it is time to enter a port or marina, it is preferable to change your towing method to tow alongside. Towing alongside makes it easier to control the towed vessel. You will have to shorten the tow to pass from the stern tow to the alongside tow using the following procedure:

- Before stopping to shorten the tow, inform the disabled vessel's occupants of your intentions. Brief them on exactly what you expect them to do during the shortening process;
- Brief your crew on the intended shortening procedure;
- Choose an area that is away from traffic and provides room to manoeuvre. Be alert for set and drift or local hazards;
- Reduce speed gradually and watch your towline at all times. Sudden speed reduction could cause the towed vessel to close in on you quite rapidly. An overtaking or ramming situation could result;
- Heave in the slack from the towline to bring the disabled boat alongside, or have the disabled vessel drop the towline and manoeuvre your vessel alongside the other craft;
- Remove towing shape and/or adjust towing lights;
- An alternative docking procedure for smaller vessels is to tow them directly to the dock or mooring on a short stay and pass the line ashore. The vessel can then be hand-pulled into the berth or mooring. In the case of a larger vessel towing a smaller one, this can be the safest method;
- If suitable dock space is unavailable, it may be prudent to anchor the disabled vessel rather than risk damage by placing it in unsuitable moorage.

10.9.3 Securing alongside

This is best achieved with four securing lines:

- The bowline is connected from your bow to the towed vessel's bow. The purpose of this line is to keep the disabled vessel's bow in to your bow. If it is too loose, the two vessels will form a wedge as you move ahead;
- The stern line is connected from inboard of your stern to outboard of the disabled vessel's stern and serves to keep the two sterns secured together;
- The forward spring line is secured from your bow to the towed vessel's stern. This line bears the strain resulting from forward movement;
- The after spring line runs from your stern to the towed vessel's bow. This line bears the strain from backing down.

The spring lines serve to reduce surging between the vessels. They should be positioned as close to the fore and aft line as possible to concentrate the forces in line with the keel, thus providing additional control. The spring lines will be carrying most of the towing strain. Increasing the length of the spring lines decreases the shock load and reduces the chances of a line giving way under strain.

The positioning of alongside lines will differ, depending on the location of securing places on the disabled vessel and on its size. However, a generic procedure for securing alongside is detailed below:

- Lead the towline to your bow for the bowline or pass a bowline if you have retrieved the towline. Secure the after spring line to gain control of the vessel. Always pass the eye of the line to the disabled craft and maintain the working end aboard your vessel. If you do not have a crewmember attaching lines aboard the disabled vessel, you must supervise the line placement;

- Secure the bowline, keeping the bow of the towed vessel slightly “toed” in to your bow;
- Secure the forward spring line;
- Place your stern well aft of the towed vessel to maintain the effectiveness of your screws and rudders;
- Secure the stern line;
- Slowly back down to remove slack from the forward spring line. Go ahead slowly to remove slack from the after spring line. Once these lines are tightened, the vessel is ready to proceed to docking.

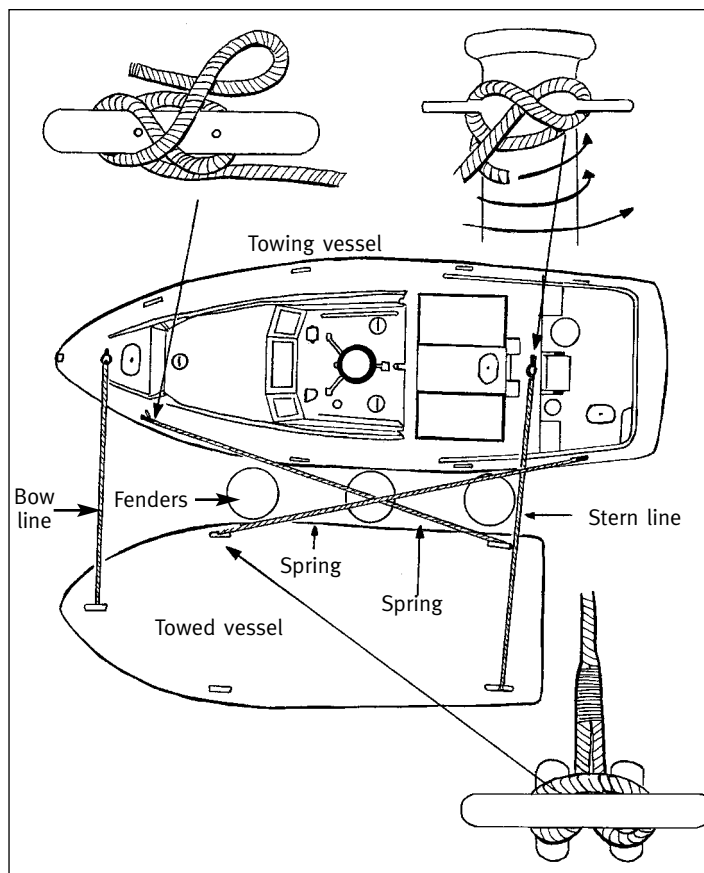

Figure 10.14: Securing alongside

10.10 ENTERING A MARINA WITH A VESSEL IN TOW

For most towing operations, it is preferable to shorten the tow and take the vessel alongside before entering the marina. However, under some circumstances, it is possible to enter a marina and dock a vessel that is still astern. On those rare occasions, you will still need to shorten the tow. This procedure is difficult and should be tried only with very experienced crews and sufficient manoeuvring space within the marina. The general procedure for entering a marina with a vessel in tow is as follows:

- Shorten the tow before entering;
- Take the vessel alongside if necessary;
- Call the marina (most can be contacted on VHF channel 68) and ask for depth and

- space available. If necessary, ask them to prepare the travel lift;
- Broadcast a “sécurité” (security) message on VHF channel 16;
- Prepare dock lines and fenders on both vessels;
- Look for power lines and other kinds of obstructions;
- Choose the closest and most accessible dock (this is usually the fuel or visitor dock).

10.11 DOCKING THE ALONGSIDE TOW

- Adjust speed slowly to maintain control of the towed vessel. Once you are underway, test the steering and stopping characteristics with the alongside tow. This will give you a feel for the manoeuvring characteristics before you approach the mooring or dock;
- Consider: wind; current; height of tide; type and location of mooring; obstructions in the vicinity of the mooring/dock; and location of personnel and docking lines;
- Determine the angle of approach and make use of a bow spotter when your visibility is obstructed by the disabled vessel. Take full advantage of the wind and current to assist in the docking procedure;
- Do not remove lines between the two vessels until the disabled vessel is properly secured and all SAR equipment and personnel are aboard the SAR vessel;
- Before leaving the disabled vessel, ensure that you have all information necessary for completing the SAR Incident Report, and offer to conduct a Courtesy Examination on the subject vessel;
- Notify RCC/MRSC;
- Tidy up your vessel as soon as possible.

When dealing with large casualties, be aware that your turning radius and pivot point will be affected dramatically. This limitation can be used to your advantage in most situations.

When the casualty is smaller than the SAR unit, there is a greater potential for it to be damaged or “crushed against the wall” in the docking approach. Therefore, the option to dock with the casualty on the outside should be considered. The SAR unit will dock first in the usual manner. Once the casualty is secured, heave it by hand to the dock. It is important to consider the wind direction and to allow sufficient space to secure the casualty.

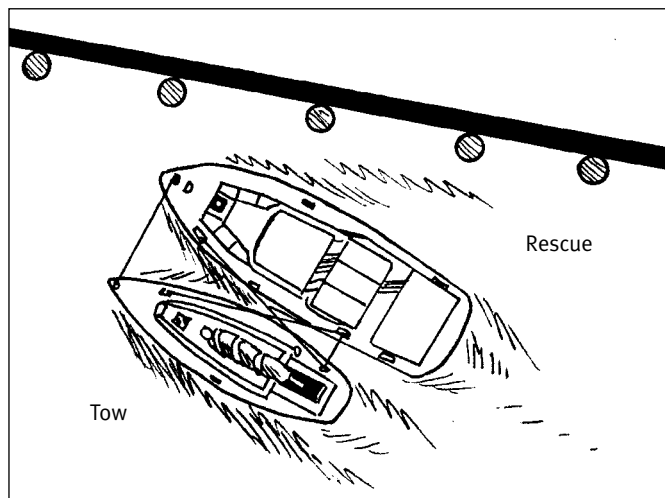

Figure 10.15: Docking with a smaller casualty

10.12 HEAVY WEATHER TOWING

Towing in rough weather

One of the most powerful shocks in the world is that of the solid sea breaking aboard a vessel. Ocean liners have had their forward deckhouses shoved in from such a blow. Oil and other barges lower in the water take a terrific beating if pulled at any speed other than dead slow in heavy seas. Pipelines, hoses, deckhouses, and on-deck stores get bent or washed overboard. Towing vessel captains and watch-standers must watch their tows. The towing vessel may be riding well while the tow is burying itself in solid water, which may appear from the towing vessel to be just heavy spray.

If a tow is caught in a storm at sea, speed and course should be adjusted to allow the towing vessel to heave to. The towline should be regulated so that the towing vessel and her tow rise together on each sea and drop together in the trough. This eases the strain on the towline and the pounding on the tow. In some areas, if the sea is not too great, and the tow is light of draft, or can stand to be turned in a reverse course, it may be prudent to run before the bad weather for awhile until conditions improve. For example, an empty oil barge should not be pulled at full speed by a tug when seas are over 1.6 or 2 m (5 or 6 ft.)

Heavy weather

There are no specific rules to follow if heavy weather conditions appear to be approaching a tow at sea. Common seamanship indicates that early action should be taken to direct the tow's course away from the storm. As modern weather forecasts give early warnings, there should be sufficient time to plan, unless of course, the tow is unlucky enough to be in the area where the storm is originating.

The first consideration is to head toward a safe port, if one can be reached before the storm catches the tow at sea. In some areas, it may be safer at sea if there is enough time and room to avoid all but the fringes of the storm. On a towing vessel with a tow that is about to be caught in a storm at sea, preparations for the worst should be made even if it appears that the storm's worst fury will miss the vessels. Any spare lines or gear that might be lifted by seas should be double-lashed. Lines swept overboard have tangled in the towing vessel's propellers. Loose lockers and drums have rammed deckhouses, broken off fuel vents, and stove in watertight doors. All of this has caused disasters to towing vessels in a sort of domino effect. In these disasters, the propeller became jammed or an unexpected opening admitted seawater. Power was lost. Steering was lost. The towing vessels became helpless ships buffeted until they capsized, filled and sank. Lives were lost.

Early action can prevent much of this from happening. The towing vessel's position, condition, and action planned should be passed to other ships in the vicinity and to shore-based SAR facilities as well as the towing vessel's operational base. On board, the primary concerns are watertight integrity and a continuous flow of electrical power and fuel to the engine(s).

Check the towing hawser to ensure that its securing nuts or clamps, (which under extreme conditions might have to be released), are free and not frozen with rust. If the storm begins to affect the towing vessel, off-watch crewmembers should be alerted. Added watch standers and lookouts may be required. As a safety measure, and without causing alarm, the crew should put on survivor's suits or life jackets. The EPIRB should be checked to see that it will float freely. A plan should be made as to how a self-inflating raft can be held to the towing vessel's hull long enough for the crew to reach it and then release it. Courses on gyro and magnetic compasses should be compared in case power is lost. Any existing hand or auxiliary steering that might be required should be checked. Keeping the towing vessel afloat, hove to with the tow intact, is the target. Beyond good seamanship, the rest is in the hands of fate. Hopefully, an event such as this will end as a good exercise in preventive seamanship and self-preservation.

10.13 TOWING IN CURRENT

10.13.1 General

Towing in current contributes an additional dimension to the forces acting on both vessels. Strong currents can be as potentially dangerous as any other effect of sea or weather condition. One-knot current can produce an effect on the vessels equal to that of a 15-knot wind. The commanding officer/coxswain must allow for the effect of the current on the SAR vessel as well as on the vessel being towed. The coxswain must ascertain the predicted current in the area and measure the effects of existing conditions, calculated by observing the wake trailing from objects such as buoys, dock pilings and rocks. Take particular caution to avoid towing near strong eddies and whirlpools. Be also careful with tidal currents and rip tides. These can reach 7-8 knots in certain areas!

Towing in current can be said to fall into one of three situations:

- towing upstream;
- towing downstream;
- towing across or diagonal to the current.

10.13.2 Towing upstream

Towing a vessel against the current is dependent on two basic factors:

- the power and manoeuvring capabilities of the SAR vessel;
- the strength of the towing gear.

The coxswain must be alert and aware of the effects of course changes in a current or stream. The towed vessel will tend to drift down current at an extreme angle to the direction of tow. One method of reducing this effect is to shorten the towline and proceed towing upstream at an acute angle to the current. As the vessels cross the current, they will drift downstream together in a line and under full control until they enter the slower moving water at the edge of the current.

If the towed vessel requires a slow towing speed and a strong current prevents you from making headway or sets you astern, do not increase power to make headway. You may

place excessive strain on the towing gear and on connecting fittings on both vessels. The prudent action may be to anchor the vessel and wait for the current to slacken or choose another location for berthing the vessel.

10.13.3 Towing downstream

As indicated above, the current will influence both boats in a similar manner. As you gradually slow your speed through the water, the towed vessels' speed through the water will likewise slow. However, both boats will continue to be carried in the direction of the current.

CAUTION

High speed towing should NOT be used to keep tension on the towline.

10.13.4 Towing across the current and/or from current to still water

Current speed may vary greatly from place to place in a narrow passage or river. The current will be stronger in the deep water. Be aware that back eddies will be present in some locations and may suddenly alter or reverse current influence on both vessels. The current may influence the tow with varied forces as you cross the current. Exercise extreme caution. Keep a constant towing watch posted. In certain circumstances, it may be preferable to shorten the towline before entering the current in order to maintain maximum control.

10.14 TOWING AIRCRAFT

10.14.1 General

Towing seaplanes or float-equipped aircraft requires special considerations. Aircraft are very fragile and can easily be damaged on contact with a vessel or object. The centre of gravity on a float-equipped aircraft can easily be moved off centre by pulling in a lateral motion, thus upsetting the aircraft. Careful and slow acceleration in a forward direction is recommended.

Aircraft also react to wind and sea conditions in a much different way from that of vessels. Heavy seas can severely damage a floatplane if the wing tips touch the surface of the water. Wind will propel the aircraft at a rapid rate of drift, and the aircraft will tend to drift facing into the wind.

10.14.2 Approach

Aircraft fuel is highly flammable. When approaching an aircraft, secure all open flames and allow no smoking at any time during the towing operation.

Approach the aircraft from upwind only and preferably from port side to be in the pilot's best field of vision (note that the pilot is usually on the left side). Aircraft drift rapidly. Approaching from downwind would place the SAR vessel in a position at the tail of the aircraft with the aircraft drifting at a much faster rate than the vessel. Approaching from outside the pilot's field of vision leaves the SAR vessel in a very vulnerable position if the

pilot should start his engine and power away without knowledge of your presence. A collision could occur. Propellers kill. Ensure that you make eye contact with the pilot.

If the aircraft has power, it should maintain station by idling into the wind. Without power it will usually lie head to the wind, but it will drift rapidly. The SRU turns bow into the wind and backs down to the aircraft. DO NOT APPROACH UNTIL THE AIRCRAFT ENGINE IS SECURE.

10.14.3 Passing the line

Do not contact the aircraft while passing the towline. Protect the aircraft from accidental touching by placing fenders between the vessel and aircraft. Fend off by hand if necessary. DO NOT USE BOATHOOKS.

It is preferable to have the aircraft crew secure the towline, but if this is not possible, be very careful in approaching to secure the line. On float-equipped aircraft, you can secure the line to the forward towing fitting on the floats, but you must keep in mind that they are very fragile. You may also use straps around the sponson braces. Do not attach the line to any part of the aircraft not designed for towing. Use a bridle. Keep clear of the propeller.

Note: Caution must be used when towing with a sponson bridle. Consult with the pilot before towing.

Aircraft that float with the fuselage in the water (i.e., seaplanes – such as a “Seabee” or “Goose”) have a towing fitting on the bow of the aircraft. These aircraft will float with one wing float in the water and the other wing float lifted out of the water. A bridle is not required for towing these craft.

10.14.4 Towing

Tow slowly and gently. A short line will help to reduce yawing. Be extremely careful in berthing operations. Contact between an object and any part of the aircraft wings or body can cause damage.

10.14.5 Lights

Aircraft being towed on the water are required to display the same lights as a vessel being towed.

10.15 PERSON OVERBOARD OPERATIONS WITH A TOW ASTERN

10.15.1 General

Note: The following description is an optional method for use only if the coxswain is familiar with it and confident of his or her ability to perform it. Otherwise, drop the tow and recover the PIW in a manner appropriate for the situation.

When a person overboard situation occurs, recovery action must begin immediately. Every second must be devoted to saving the life of the person in the water. If you happen to be towing at the time of the person overboard, and if there is no time to drop the tow, then the

pickup must be conducted with the casualty on the towline. If time permits and you are not placing the towed vessel at further risk, the towline should be dropped and the person recovered. The tow can recommence after the recovery.

As with a person overboard in a non-towing situation, all crewmembers must be capable of instantly performing their duties. Proficiency can be maintained only through practice.

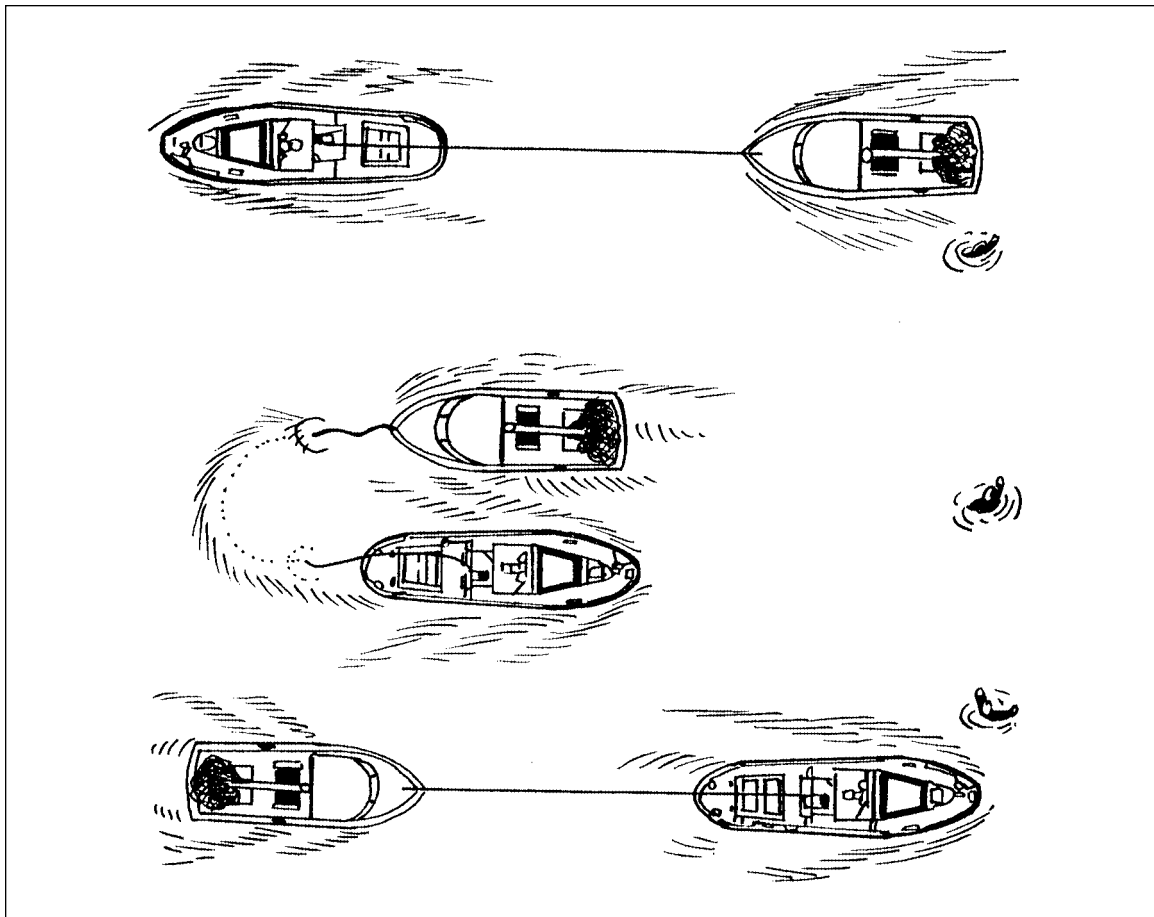

Figure 10.16: Recovering a person overboard while towing

10.15.2 Method

Coxswain

- After the “person overboard” signal is called, allow the tow to pass the person in the water. During that time, advise the towed vessel of your intentions;
- If he/she is off your vessel, notify the tow and have its crew throw flotation (life ring, etc.);
- Warn the tow to steer clear of the person overboard;
- Sound the danger signal (Oscar, person overboard);
- Mark the position by touching loran/GPS memory, throwing a datum marker, etc.;

- Once the tow has passed the person, release the throttle. The elastic recoil of the towline should bring you back a bit. Turn your vessel in the direction that will best position you to approach the person in the water. The preferred side is to windward;
- When you are 45 degrees about into your turn, apply full power as the tension on the towline is falling, and run back down your towline;
- When the towline starts picking up tension (i.e., when the towed vessel is starting to tip toward you), cut the power back, SLOW DOWN, pay out the towline if necessary, and place the person on your windward side for pickup. Try to position the towline away from the pickup person. THE FIRST APPROACH MUST BE A SUCCESS.

Pointer

- If the person is off your vessel, the pointer should be the person who saw him or her go overboard;
- Throw a datum marker;
- Move to the bow, keeping the person in sight and pointing until the person is recovered;
- When the person is approached, keep the coxswain informed of the person's position until he or she is recovered on board.

Pick up person

- Prepare a heaving line;
- Listen for instructions for the side from which the pickup will occur, and stand by at that side;
- Conduct pickup.

10.16 TANDEM TOWING**10.16.1 Methods**

Some SAR incidents require an SAR vessel to tow two or more boats at the same time. The same principles and procedures applied to single tows are used in tandem towing. However, tandem towing requires much more planning, preparation, and coordination than a single tow. Communication is the key to success. The SAR crew and the personnel aboard the disabled vessels must be fully aware of what is to take place and what is expected of them. There is a much higher risk of mishaps with tandem towing than with a single tow. The coxswain must know his or her limitations in tandem towing and, most importantly, when not to use this application. Tandem towing should not be undertaken by untrained or unseasoned coxswains.

For small SRU, there are three basic methods of tandem towing.

10.16.1.1 Honolulu method

This method is used for towing smaller vessels (up to 8 m) in fair weather conditions.

Both disabled vessels must sheer off from each other. If one has steering problems causing it to sheer off in one direction, place it so that it sheers away from the other vessel.

The most manoeuvrable craft should be placed forward and the least manoeuvrable last. Towlines should be separated as much as possible. Bridles and drogues should be used if required. Connect the least manoeuvrable vessel on the long towline first. Then pick up the more manoeuvrable vessel on the shorter line.

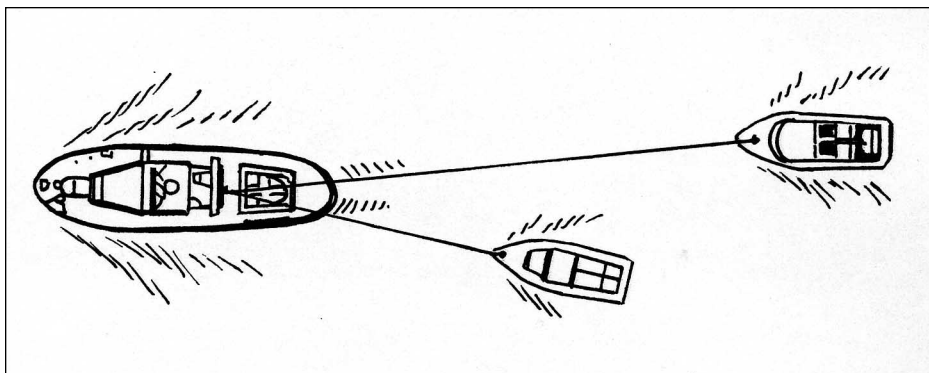

Figure 10.17: Honolulu method

10.16.1.2 Daisy-chain

The daisy-chain method should be used only over short distances in good weather conditions because of the extra stresses placed on the stern fittings of the first or forward towed vessels. This method places one vessel directly in line with the other. The first or middle vessels must agree to this type of tow. The stern fittings on these vessels will be subjected to higher than normal stresses. The second or subsequent vessels are towed by a line from the stern of the first or forward towed vessel. The largest and/or heaviest should be the first in line, with the smaller vessels strung out astern in order of decreasing size. The use of bridles on all vessels in tow is recommended, and care must be exercised to ensure that the deck fittings are suitable, particularly the stern fittings on the disabled boats to which the bridles are attached.

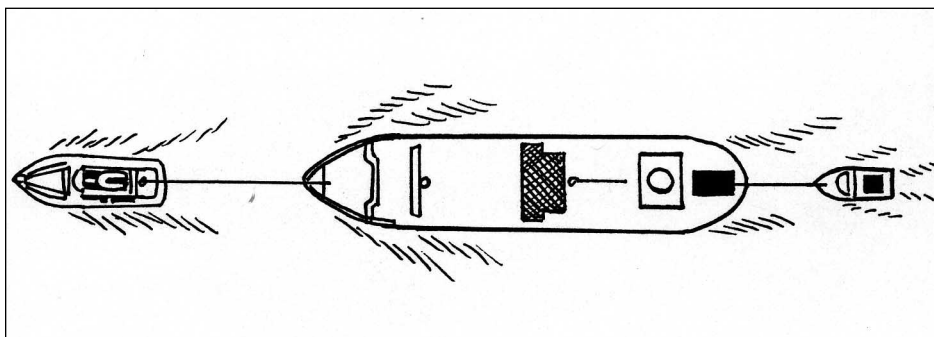

Figure 10.18: Daisy-chain method

10.16.1.3 “Y” method

The “Y” method is used for towing larger, heavier vessels against currents, seas, or wind. This method uses two SAR vessels towing off the casualty’s bow at a 45° angle. One SAR vessel must be in command and control of the operation. A bridle is not used in this operation.

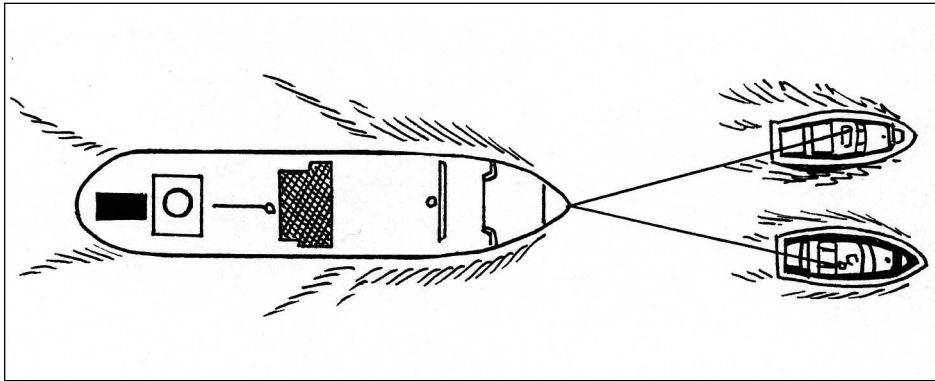

Figure 10.19: “Y” method

10.17 SINKING TOW AND A TOW ON FIRE

A vessel that is taking on water may eventually sink. If you are towing a vessel taking on water, you should always be prepared for the worst scenario. In some instances, a vessel may begin to take on water during the towing operation. Under such circumstances, you will need to initiate dewatering procedures quickly. Most of these techniques are covered in the next chapter (SAR operations, Damage Control section).

10.17.1 Passing the canister pump to a vessel in tow

Some vessels are equipped with SAR pumps contained in a waterproof canister. The SAR pump can be passed to a vessel in tow if necessary. To do so, proceed as follows:

- If a permanent bridle is not fitted, a bridle must be rigged to both handles of the pump container;
- Estimate the distance from the bow of the towed vessel to the lowest point of freeboard in an accessible working area of the vessel. Use a shackle to attach a mooring line of appropriate length to the bridle;
- Secure the other end of the mooring line to the towline by means of a bowline, with the towline passing through the eye of the bowline. A shackle of suitable size may be used instead of the bowline. The mooring line must be able to run freely along the towline;
- Lower the pump over the side and allow it to float freely to the towed vessel;
- Maintain only enough headway for steerage. This will keep the pump from submerging and prevent unnecessary damage to the towed vessel;
- Instruct the towed vessel to turn its rudder to port or starboard, into the wind or current. This will aid in allowing the pump to drift down the side of the vessel clear of the bow;

- When the bowline (or shackle) contacts the bow of the towed vessel, the pump should be alongside the vessel in the appropriate location for recovery. The crew of the towed vessel recovers the pump by pulling it aboard.

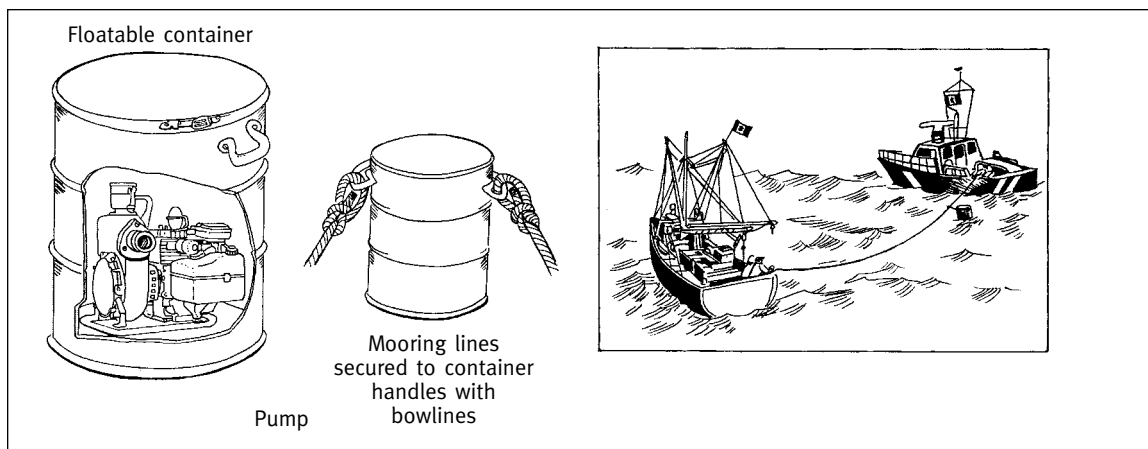

Figure 10.20: Passing the canister pump

10.17.2 Managing a sinking tow

When it becomes evident that a tow is about to sink, very quickly assess the situation. Quick decisive action to minimize loss of life is the first priority. Once abandon ship procedures are initiated, radio communications will likely be lost. The first priority is to rescue the people from either the deck of the towed vessel or the water.

Note: When a towed vessel does not behave as it should, always suspect that it is taking on water. The weight of the water in the bilges will often cause the vessel to look more stable than it should. When in doubt, have someone inspect the bilges.

A sinking tow can pull the stern of the towing vessel under unless all crewmembers pay close attention to the immediate situation. There may not be enough time to disconnect the towline from the towed vessel once it begins to sink.

If a tow begins to sink, stop all towing vessel headway. The force exerted through the towline increases the danger of the towed vessel yawing and capsizing.

Perform the following procedures:

- When it becomes obvious that sinking cannot be avoided, e.g., the tow has rolled on one side and is not righting itself or the tow's decks are submerging, cut the towline or slip the towline by breaking the bitt;
- Note the vessel's position by GPS, Loran or radar fix and request assistance. Once free of the tow, make preparations to rescue the tow's occupants.

CAUTION

Be aware that the boat could become fouled in rigging or debris while you are attempting to rescue survivors.

If there was no one on board the tow, the water is shallow (depth less than towline length), and safety permits, pay out the towline until the tow reaches bottom. Tie a fender, life jacket or floatable object to the towline so it is visible on the surface, then cut the towline. The floating object will mark the location of the sunken vessel for later salvage.

10.17.3 Fire on a towed vessel

Fire occurring on a towed vessel requires immediate action by the SAR crew. The response criteria will be no different from those for any other fire, except for the fact that the SAR vessel is tethered to the vessel on fire by a towline. The coxswain must take the following actions immediately:

- RELEASE TOW;
- EVACUATE CREW;
- ASSESS SITUATION.

If the fire is in an early stage or has not built up to a point where fighting it would expose both crews to any risks, it might be advisable to fight the fire. Refer to the fire-fighting section of Chapter 11 for more details. Make full use of any information that the crew of the towed vessel can provide. **DO NOT ALLOW THE VESSEL CREW TO RE-BOARD THE VESSEL AND FIGHT THE FIRE.** Though possibly difficult in the case of a distressed vessel owner and crew, such restraint is essential to protect their personal safety.

10.18 TOWING PRECAUTIONS CHECKLIST

- Maintain communications between boat operator and crew;
- Have all people on board the disabled vessel don PFDs. If they do not have enough PFDs, provide them;
- Remove all people from the disabled vessel when necessary, safe or practical;
- Cast heaving lines well over the boat's centre mass so that they drop over the deck. Ensure that people on board are prepared to receive the heaving line;
- Establish and maintain clear communications with the towed vessel, including a backup means of communicating. Provide a portable radio if necessary. At minimum, contact the tow every 30 minutes, more frequently if conditions warrant. Initially, get the following information from the operator of the disabled vessel:
 - condition of towline, chafing gear, towline attachment points, and deck hardware
 - level of water on board / rate of flooding (if taking on water)
 - physical condition of people on board;
- When underway, keep personnel on board both vessels well clear of the tow rig;
- Keep the tow rig attachment points as low and as close to the centreline as possible;
- Do not connect the tow rig to lifelines, stanchions, grab rails or ladders;
- Do not attach the tow rig to deck fittings that are attached by screws only;
- Avoid using lines provided by the disabled vessel for any part of the tow rig;

- Avoid using knots to join towlines;
- Tend a towline by hand until it is secured to the disabled vessel. Then secure it to a bitt or cleat when directed by the tow vessel operator;
- Do not secure a towline to a bitt or cleat with half hitches;
- A crewmember working the bitt or cleat must avoid crossing arms when securing the line. Change hands to avoid becoming fouled in the turns;
- Ensure that the breaking strain of all shackles used in the tow rig is equal to or greater than the breaking strength of the towline;
- Keep the towline clear of propellers, shafts and rudders;
- Use chafing gear to minimize damage to a tow rig;
- Avoid towing a boat that exceeds your capabilities or those of your vessel;
- Tow at a safe speed for the prevailing conditions. Avoid shock loading the tow rig;
- Do not exceed the hull design speed of the towed vessel. Remember that sailboats have a low hull design speed;
- Avoid sudden manoeuvres and sharp turns;
- Use a drogue if necessary to reduce or prevent yawing;
- Have someone at the helm of the disabled vessel, if possible. Direct them to steer directly on the stern of the towing vessel. If all personnel have been removed from the disabled vessel, secure the rudder amidships. If the towed vessel has an outboard or outdrive, ensure that it is in the full down position. If the vessel has an inboard engine, secure the propeller shaft;
- Keep a towed vessel in trim. Consider the following:
 - condition of the vessel (structural damage, taking on water, etc.)
 - structural design of the boat (low transom, low freeboard, etc.)
 - cargo (fish holds, gear stowage, etc.) and the free surface effect (dynamics of free moving water in the bilge of a boat) on ride;
- Maintain a diligent towing watch and frequently account for all people on board the disabled vessel, either visually or by radio;
- Ensure that the breaking strength of bridles in a tow rig are equal to or greater than the breaking strength of a towline and appropriately matched to the requirements of the tow and prevailing conditions;
- If possible, complete all chartwork and preparations at the dock. It is very difficult to do this while underway with a tow;
- If the possibility exists that a drogue or pump may be required while under tow, transfer the equipment before the tow commences;
- After a tow rig is established, but before any strain is taken, an experienced individual should inspect the full rig;
- When approaching a disabled vessel, STOP, ASSESS and PLAN (SAP);
- Always maintain your situational awareness. When securing a tow in heavy weather, the prevailing wind and wave conditions may make it necessary to commence your tow in a direction opposite to your intended course. Know where you are going!

- Choose your destination carefully, keeping the following questions in mind:
 - Do I have sufficient fuel endurance to complete the tow?
 - Can I get fuel in this harbour or will I have sufficient fuel on board to return to base?
 - Will the prevailing weather conditions allow me to enter this harbour with a tow?
 - Does this harbour have sufficient facilities and services to accommodate the disabled vessel (i.e., a marine haul-out for a vessel that is taking on water)?
- Be careful if you tow a vessel from salt to fresh water. The buoyancy of the vessel will change during the transition. A heavily loaded vessel may lose buoyancy to the point where safety may be compromised.

CHAPTER 11 – SAR OPERATIONS

11.1	Awareness and initial actions	11-7
11.2	SAR stages	11-7
11.2.1	Awareness	11-7
11.2.2	Initial action	11-7
11.2.3	Planning	11-8
11.2.4	Operations	11-8
11.2.5	Conclusion	11-8
11.3	Emergency phases	11-8
11.3.1	Uncertainty phase	11-8
11.3.2	Alert Phase	11-8
11.3.3	Distress phase	11-9
11.4	Awareness stage: Methods for communicating distress	11-9
11.4.1	Distress signals targeted to rescue centres	11-9
11.4.2	Distress signals targeted to anyone nearby	11-10
11.4.3	Radio communications	11-11
11.4.3.1	MAYDAY	11-11
11.4.3.2	PAN-PAN	11-11
11.4.3.3	SÉCURITÉ	11-11
11.4.3.4	Radio alarm signal	11-11
11.4.4	Receiving a distress message	11-12
11.4.5	Pyrotechnics	11-13
11.4.6	Flag hoists	11-13
11.4.7	Hand signals	11-13
11.4.8	Light signals	11-13
11.5	Initial action stage	11-13
11.6	Timing of an SAR mission	11-14

11.7	SAR communications	11-14
II.7.1	Communication methods	II-15
II.7.2	SITREPS	II-15
II.7.3	Communication priorities	II-15
II.7.4	Release of information to the media and the public	II-15
11.8	Planning	11-16
II.8.1	Before departure and during transit	II-16
11.9	Basic search planning	11-17
II.9.1	Datum	II-17
II.9.1.1	Datum point	II-17
II.9.1.2	Datum line	II-17
II.9.1.3	Datum area	II-17
II.9.2	Forces affecting datum	II-18
II.9.2.1	Leeway	II-18
II.9.2.2	Local wind-driven current	II-18
II.9.2.3	Sea current	II-18
II.9.2.4	Tidal current	II-18
II.9.2.5	River current	II-18
II.9.3	Search area description	II-19
II.9.3.1	Corner point	II-19
II.9.3.2	Trackline	II-19
II.9.3.3	Centre point (circle)	II-19
II.9.3.4	Centre point (rectangle)	II-20
II.9.3.5	Centre point-landmark (rectangle, bearing and distance)	II-20
II.9.3.6	Landmark boundaries	II-21
11.10	Search patterns	11-21
II.10.1	Search pattern designation	II-21
II.10.1.1	Square patterns (S)	II-22
II.10.1.2	Sector patterns (V)	II-22
II.10.1.3	Parallel track patterns (P)	II-23
II.10.1.4	The creeping line single-unit pattern (CS)	II-24
II.10.1.5	The trackline single-unit return pattern (TSR)	II-24
II.10.2	Additional search patterns	II-24
II.10.2.1	Barrier	II-24
II.10.2.2	Shoreline search	II-25

II.10.3	Initial response	II-25
II.10.3.1	Initial response search area	II-25
II.10.3.2	Procedure	II-25
II.10.4	Communications with RCC/MRSC	II-26
II.10.5	Appropriate search pattern	II-26
II.10.6	Search area coverage	II-27
II.10.6.1	Sweep width (W)	II-27
II.10.6.2	Track spacing (S)	II-27
II.10.6.3	Commence search point	II-28
II.10.7	Search preparation	II-28
II.10.7.1	Brief crew and lookouts	II-28
II.10.7.2	Search object briefing	II-29
II.10.7.3	Lookout assignments	II-29
11.11	Conducting a search	11-30
II.11.1	Visual search procedures	II-30
II.11.2	Locating the search object	II-31
II.11.2.1	Locating surface craft	II-32
II.11.2.2	Locating overdue vessels	II-33
II.11.2.3	Locating disoriented or lost vessels	II-34
II.11.2.4	Locating abandoned vessels	II-34
II.11.2.5	Locating distressed aircraft	II-34
II.11.2.6	Locating person in the water	II-35
II.11.3	Foundered or sunken vessels	II-35
II.11.4	Search reduction	II-35
II.11.4.1	Cessation of searches	II-35
11.12	Rescue	11-36
II.12.1	Arriving on scene	II-36
II.12.2	Recovering persons in the water	II-37
II.12.2.1	General guidelines	II-38
II.12.2.2	Methods of recovery	II-38
II.12.3	Rescue of persons from burning vessels	II-39
II.12.3.1	Guidelines	II-40
II.12.3.2	Vessel on fire at fuel docks and marinas	II-42
II.12.4	Rescue from survival craft	II-42

11.13	Grounded vessels and damage control	11-43
II.I3.1	Broaching	II-44
II.I3.2	Pounding	II-44
II.I3.3	Refloating procedures	II-45
II.I3.3.1	Straight pull	II-46
II.I3.3.2	Wrenching and pulling	II-47
II.I3.3.3	Bow-on pull	II-47
II.I3.3.4	Scouring	II-48
II.I3.3.5	Heeling sailing vessels	II-48
II.I3.4	Damage control in SAR incidents	II-49
II.I3.4.1	Water flow control methods	II-49
II.I3.5	Suggested damage-control kit	II-51
11.14	Rescue of capsized vessels	11-52
II.I4.1	Righting powerboats	II-52
II.I4.1.1	Righting a powerboat by parbuckling	II-53
II.I4.1.2	Righting using bow and transom eyebolt	II-53
II.I4.1.3	Righting using towline fore and aft of boat's keel	II-54
II.I4.1.4	Refloating swamped boats astern using trailer eyebolt	II-56
II.I4.2	Righting small sailboats	II-56
II.I4.3	Righting larger vessels	II-57
II.I4.3.1	Righting technique	II-58
II.I4.4	Kayaks, canoes and small rowboats	II-58
II.I4.5	Rescue of a vessel drifting onto a lee shore	II-59
II.I4.6	Grounded vessels on lee shore or in other danger	II-59
II.I4.7	Boosting another vessel	II-60
II.I4.7.1	Procedure for boosting	II-61
II.I4.8	Escorting a vessel	II-62
II.I4.8.1	Escorting procedure	II-62
11.15	Removing/delivering persons from/to shore	11-62
II.I5.1	Procedure	II-62
II.I5.1.1	Life Raft method	II-64
11.16	Removing/delivering persons from/to other vessels	11-65
II.I6.1	General guidelines	II-65
II.I6.2	Use of life raft for transfer	II-66

II.I6.3	Patients in stretchers	II-67
II.I6.4	Larger ocean-going vessels	II-67
II.I6.5	Passenger ship	II-69
II.I6.6	Ship at anchor	II-69
II.I6.7	Heavy weather	II-69
11.17	Aircraft rescue	11-70
II.I7.1	Airborne	II-70
II.I7.2	Ditching nearby – general guidelines	II-70
II.I7.3	Helicopter ditching	II-71
II.I7.4	Aircraft crash – general guidelines	II-71
11.18	Rescue operations with DND planes and helicopter	11-72
II.I8.1	Equipment Drops	II-72
II.I8.1.1	Survival Kit Air Droppable (SKAD)	II-72
II.I8.1.2	Air-droppable pump	II-72
II.I8.1.3	Parachute drops	II-72
II.I8.2	Joint operations with DND helicopters	II-73
II.I8.2.1	Preparation of the SRU	II-73
II.I8.2.2	Control of deck operations	II-74
II.I8.2.3	Positioning of vessel and conduct of normal hoist process	II-74
II.I8.2.4	Aircraft engine failure	II-75
II.I8.2.5	Aircraft emergency entry	II-75
11.19	Recovering submerged victims	11-76
II.I9.1	What agencies can recover victims?	II-77
II.I9.2	General guidelines	II-77
11.20	Mission conclusion	11-78

11 SAR OPERATIONS

11.1 AWARENESS AND INITIAL ACTIONS

When the SAR system first becomes aware of an actual or potential emergency, the information collected and the initial action taken are often critical to successful SAR operations. It must be assumed that in each incident there are survivors who will need assistance and whose chances of survival are reduced by the passage of time. The success of an SAR operation depends on the speed with which the operation is planned and carried out. Information must be gathered and evaluated to determine the nature of the distress, the appropriate emergency phase, and the action to be taken. Prompt receipt of all available information by the RCC/MRSC is necessary for thorough evaluation, immediate decision on the best course of action, and a timely activation of SAR facilities to make it possible to:

- locate, support and rescue persons in distress in the shortest possible time; and
- use any contribution that survivors may be able to make towards their own rescue while they are still capable of doing so.

Experience has shown that the chances for survival of injured persons decrease by as much as 80% during the first 24 hours, and that those for uninjured persons diminish rapidly after the first three days. Following an accident, even uninjured persons who are apparently able-bodied and capable of rational thought are often unable to accomplish simple tasks, and are known to have hindered, delayed or even prevented their own rescue.

This section introduces the five stages of an SAR response, briefly describes three emergency phases of an SAR incident and provides basic information about the first two SAR stages.

11.2 SAR STAGES

The response to an SAR incident usually proceeds through a sequence of five stages. These stages are groups of activities typically performed by the SAR system in responding to an SAR incident from the time the system becomes aware of the incident until its response to the incident is concluded. The response to a particular SAR incident may not include every stage. For some incidents, the activities of one stage may overlap the activities of another stage such that portions of two or more stages are being performed simultaneously. The five SAR stages are described below:

11.2.1 Awareness

Knowledge by any person or agency in the SAR system that an emergency situation exists or may exist.

11.2.2 Initial action

Preliminary action taken to alert SAR facilities and obtain more information. This stage may include evaluation and classification of the information, alerting of SAR facilities, communication checks, and in urgent situations, immediate performance of appropriate activities from other stages.

11.2.3 Planning

The development of operational plans, including plans for search, rescue, and final delivery of survivors to medical facilities or other places of safety as appropriate.

11.2.4 Operations

Dispatching SAR facilities to the scene, conducting searches, rescuing survivors, assisting distressed craft, providing necessary emergency care for survivors, and delivering casualties to medical facilities.

11.2.5 Conclusion

Return of SRUs to a location where they are debriefed, refuelled, replenished, and prepared for other missions, as well as return of other SAR facilities to their normal activities, and completion of all required documentation.

This section discusses the first two stages, awareness and initial action and should give you a general understanding of how the SAR system works. These two stages will rarely involve SRUs. SRUs are usually recruited for the other three stages.

11.3 EMERGENCY PHASES

Emergency phases are based on the level of concern for the safety of persons or craft which may be in danger. Upon initial notification, an SAR incident is classified by the notified RCC/MRSC as being in one of three emergency phases: Uncertainty, Alert, or Distress. The emergency phase may be reclassified by the RCC/MRSC as the situation develops. The current emergency phase should be used in all communications about the SAR incident as a means of informing all interested parties of the current level of concern for the safety of persons or craft which may be in need of assistance.

11.3.1 Uncertainty phase

An uncertainty phase is said to exist when there is knowledge of a situation that may need to be monitored, or to have more information gathered, but that does not require dispatching of resources. When there is doubt about the safety of an aircraft, ship, or other craft or persons on board, or it is overdue, the situation should be investigated and information gathered. A communication search may begin during this phase. An Uncertainty Phase is declared when there is doubt regarding the safety of an aircraft, ship or other craft, or persons on board.

11.3.2 Alert phase

An Alert Phase exists when an aircraft, ship, or other craft or persons on board are having some difficulty and may need assistance, but are not in immediate danger. The alert phase is usually associated with apprehension, but there is no known threat requiring immediate action. SRUs may be dispatched or other SAR facilities diverted to provide assistance if it is believed that conditions might worsen or that SAR facilities might not be available or able to provide assistance if conditions did worsen at a later time. For overdue craft, the alert phase is considered when there is a continued lack of information concerning the progress

or position of a craft. SAR resources should begin or continue communications searches, and the dispatch of SRUs to investigate high-probability locations or overfly the craft's intended route should be considered. Vessels and aircraft travelling through areas where the concerned craft might be located should be asked to maintain a sharp lookout, report all sightings and render assistance if needed.

11.3.3 Distress phase

The distress phase exists when there is reasonable certainty that an aircraft, ship, or other craft or persons on board is in danger and requires immediate assistance. For overdue craft, distress exists when communications searches and other forms of investigation have not succeeded in locating the craft or revising its ETA so that it is no longer considered overdue. If there is sufficient concern for the safety of a craft and the persons aboard to justify search operations, the incident should be classified as being in the distress phase.

11.4 AWARENESS STAGE: METHODS FOR COMMUNICATING DISTRESS

The SAR system's first notification of an actual or potential SAR incident initiates the awareness stage. Persons or craft in difficulty may report a problem, alerting posts may receive information, nearby personnel may observe an incident, or an uncertainty may exist due to lack of communication or non-arrival. Anyone who becomes aware of an actual or potential SAR incident should report it immediately to the appropriate RCC/MRSC. If an SRU receives the information, it should also respond to the incident as appropriate.

Many methods for communicating distress are available to those involved in a maritime distress situation. Some of these communication methods are targeted directly to the rescue centres, while others aim to be seen or heard by anyone nearby. These methods of communication are described next.

11.4.1 Distress signals targeted to rescue centres

These will be seen or heard by the RCC/MRSC first. Then, the RCC/MRSC will relay the information to the other players of the SAR system. Among these means of communication are:

- phone calls (through the RCC/MRSC emergency line);
- EPIRBs and ELTs.

11.4.2 Distress signals targeted to anyone nearby

Most important to your operations are the distress signals that you may see or hear. In some situations, you may be the only link between the vessel in distress and the SAR system. Knowing the distress signals and knowing how to respond to them is of paramount importance for anyone involved in maritime search and rescue.

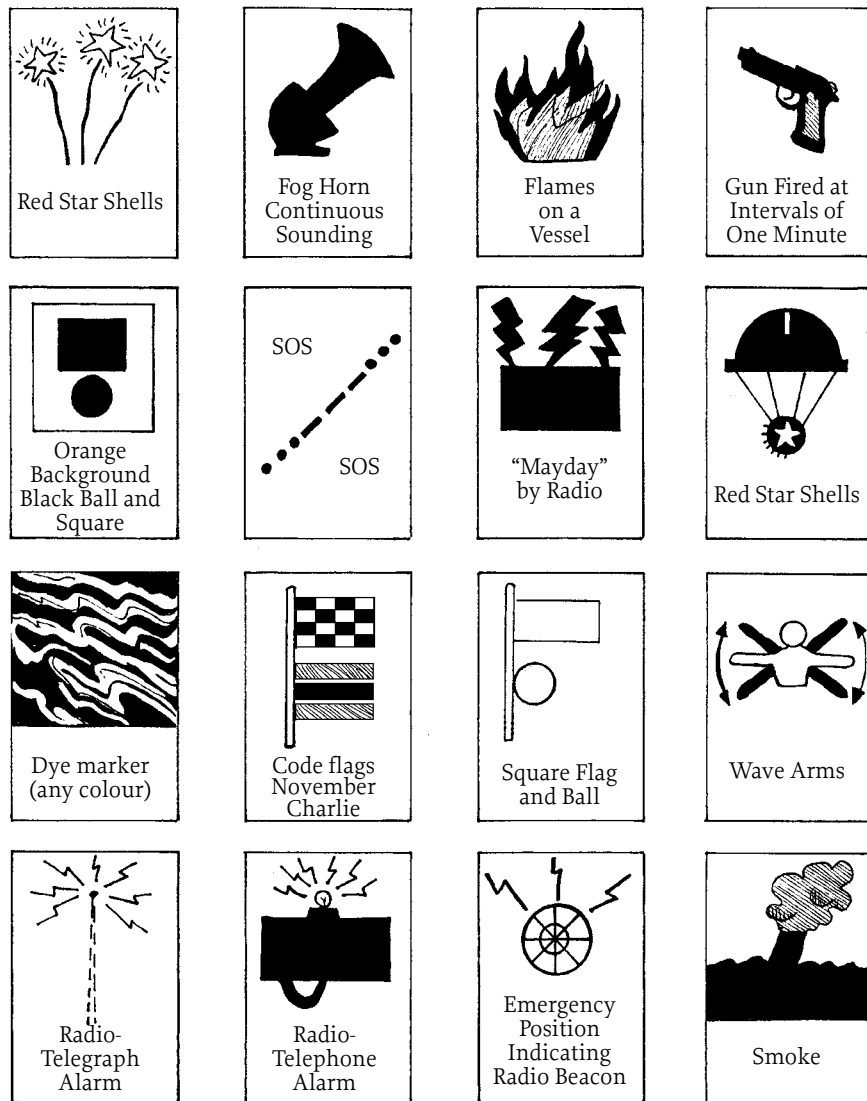

Figure 11.1: Distress signals

Note: Any unusual signal or action you see could be a signal that a craft is in trouble. You should investigate any peculiar or suspicious signals such as the Canadian flag flown upside down or continuous sounding of a horn or fog-signaling device.

11.4.3 Radio communications

When an emergency occurs, different prowords can be used to show the degree of urgency. Hearing one of these urgency calls should trigger specific responses in a listener, such as preparing to collect information on an emergency or refraining from transmitting on the frequency until all is clear. It is normally the responsibility of the MCTS to answer radio distress calls. SRU should respond directly to distress calls only if the MCTS has not responded. The meaning of each urgency call is outlined below.

11.4.3.1 MAYDAY

MAYDAY is a distress call of the highest priority. Spoken three times, it shows that a person, boat, or aircraft is threatened by grave or imminent danger and requires immediate assistance.

A MAYDAY call has absolute priority over all other transmissions and is not addressed to a particular station. All units hearing a MAYDAY call should immediately cease transmissions that may interfere with the distress traffic, and continue to listen on the distress message's frequency.

If the unit transmitting the distress call is determined to be some distance from you, pause a few moments to allow MCTS to answer. Note all the information regarding the distress situation. If MCTS does not respond, you may have to relay that information to them.

Note: When working a distress situation on Channel 16, do not attempt to change (shift) to a working channel until enough information is obtained to handle the distress, in case communications are lost during the act of shifting.

11.4.3.2 PAN-PAN

This urgency signal consists of three repetitions of the group of words "PAN-PAN" (PAHN-PAHN). It means that the calling station has a very urgent message to transmit concerning the safety of a ship, aircraft, vehicle, or person.

11.4.3.3 SÉCURITÉ

"SÉCURITÉ" (SEE-CURE-IT-TAY) is a safety signal spoken three times and transmitted on 2182 kHz or Channel 16. It indicates a message on the safety of navigation, or important weather warnings which will be transmitted on another channel soon (such as 21, 22, 83, etc.).

11.4.3.4 Radio alarm signal

The radio alarm signal consists of two audible tones of different pitch sent alternately, producing a warbling sound. If used, the alarm sends the signal continuously for not less than 30 seconds and not more than one minute, and the recipient of the signal should follow the signal by the radio distress signal and message. There are two primary reasons to use a radio alarm signal:

- to attract the attention of listeners on the frequency;
- to actuate the automatic listening devices found on large ships and occasionally at shore stations.

11.4.4 Receiving a distress message

In the areas where communications with one or more MCTS stations are practicable, ships should wait a short period of time to allow these stations to acknowledge receipt. If MCTS does not respond, and when the distressed unit is in your vicinity, acknowledge receipt of the message. Take all the information and relay that info to MCTS or RCC/MRSC. However, if the unit is determined to be some distance from you, pause a few moments to allow ships or stations nearer the scene to answer.

The receipt of distress messages should be in the following manner:

- the distress signal MAYDAY;
- the call sign of the unit in distress (spoken three (3) times);
- the words THIS IS (spoken once);
- the call sign of your unit (spoken three (3) times);
- the words RECEIVED MAYDAY;
- request essential information needed to effect assistance (position, number of people on board, nature of distress, vessel's description). Obtain less important information in a later transmission;
- the proword OVER.

Inform the distressed unit of any assistance being dispatched and direct them to stand by.

Vessels and shore stations receiving distress traffic should do the following by the most rapid means:

- Forward the information to the MCTS or RCC/MRSC;
- Set a continuous radio watch on frequencies of the distress unit;
- Maintain communications with the distressed unit;
- Maintain distress radio log;
- Keep the RCC/MRSC informed of new developments in the case;
- Obtain radio direction finder bearing of distressed unit if equipment and conditions permit.

Every SRU which acknowledges receipt of distress messages shall transmit the following information to the unit in distress as soon as possible, after ensuring it will not interfere with stations in a better position to render immediate assistance:

- acknowledgment of unit's name and position;
- speed of advance of assisting unit to scene;
- estimated time of arrival at scene.

Keep the distressed unit informed of any circumstances that may effect your assistance, such as speed, sea conditions, etc. Speak in a tone of voice that expresses confidence. After receiving a distress call or information pertaining to one, the SRU shall, (within equipment capabilities), set a continuous radio guard on the frequency of the distressed unit and set up a radio schedule if the distressed unit is unable to stand a continuous watch.

11.4.5 Pyrotechnics

The following are some pyrotechnic emergency signals you may encounter:

- gun or explosive signal fired at about one minute intervals;
- red or orange flare fired one at a time in short intervals;
- rocket parachute showing a red light;
- smoke;
- any flame on a vessel may be used for signaling.

11.4.6 Flag hoists

Flag hoists are a quick method of emergency signaling, but can only be used in the daytime.

These are some of the best known examples:

- a square flag with a ball, or ball-shaped object above or below the flag;
- an orange flag;
- November Charlie (N/C) flag.

11.4.7 Hand signals

Possibly the oldest form of signaling is hand signals, but like other methods of visual communication, the signals are not standardized and can be easily misunderstood. Crew members must be constantly alert for hand signals being sent by other mariners that are not standard distress signals, but that may be attempts to indicate an emergency situation.

These three standard hand signals are used as distress signals:

- slowly raising and lowering an outstretched arm;
- signaling with an oar raised in the vertical position;
- holding a life jacket aloft.

11.4.8 Light signals

The Morse Code symbols “SOS” (Save Our Ship) transmitted by a flashing light may be used to communicate distress.

S = . . . O = — — — S = . . .

Strobe lights (possibly attached to a personal flotation device) can also be used. Distress strobe lights will usually emit 50-70 flashes per minute.

11.5 INITIAL ACTION STAGE

The initial action stage is entered when the SAR system begins response, although some activities, such as evaluation, may begin during the preceding awareness stage and continue through all stages. Initial action may include the designation of an SAR mission coordinator (from the staff of a RCC/MRSC), incident evaluation, emergency phase classification, SAR resources alert and communication searches.

11.6 TIMING OF AN SAR MISSION

The order of events in an SAR incident is thus as follows:

- RCC/MRSC is made aware of a marine distress. This could be by telephone from any source, by marine radio from a distress vessel to a MCTS, or by a radio call from another vessel;
- RCC/MRSC gathers information on the case and uses its authority to task vessels;
- The vessel or vessels to be tasked are alerted by a variety of means including radio, telephone, pager, 9-1-1 System, or other emergency alert system;
- If alerted by telephone, an SRU is normally given available information and a tasking (incident) number at that time;
- If alerted by other means, vessels normally contact the RCC/MRSC by telephone (or any other available means) for further information and a task number;
- When ready to launch, or ready to depart, the vessel informs RCC/MRSC with a SITREP of their readiness and situation through MCTS. The MCTS may have further information and instructions from RCC/MRSC and will indicate whether the task is to go forward;
- If a vessel is already on the water when it is alerted, it will be given instructions about the task, a task number, and directions on how to proceed;
- Tasked vessels proceed with the task and transmit SITREPS as necessary or as requested by RCC via MCTS;
- It is normal, and highly recommended, that communications with RCC/MRSC be conducted by VHF communications to the MCTS. The MCTS is in constant and immediate contact with RCC/MRSC and will transmit information and instructions between the SRU and the controller at RCC/MRSC;
- The MCTS will indicate which radio channel is to be used and the frequency of SITREPS they prefer;
- In emergency or special circumstances, you may request MCTS to connect you directly to RCC/MRSC through a duplex channel. This involves the MCTS setting up a radiotelephone connection through a landline to RCC/MRSC.

11.7 SAR COMMUNICATIONS

For any SAR incident, the standard VHF communications procedures are followed. This includes Marine Information broadcasts, Maydays, and Mayday relays. Vessels are required to maintain a continuous radio watch on channel 16 or any frequencies allotted by the controlling authority during a search. When communicating with any civil agencies (e.g., police forces), civil communications procedures may be adopted and employed.

All communications with both the RCC/MRSC and any MCTS are recorded. These daily recordings are kept in secure storage in the event of any legal ramifications.

11.7.1 Communication methods

Communications with RCC/MRSC can be conducted via two modes. One is by telephone (land-based, cellular and satellites) and the other is by radio through the assistance of a radio operator at an MCTS. The RCCs/MRSCs and MCTSs are all linked with dedicated telephone circuits.

It is good practice to log all radio transmissions to and from your station. Also, writing down messages before you send them ensures that all information gets transmitted correctly. When initiating SAR communications with a MCTS, the operator will state “This is Coast Guard/auxiliary vessel (vessel’s name) with SAR priority traffic. Over.”

The only reason NOT to send information through the MCTS is if the information is of a sensitive nature.

11.7.2 SITREPS

The following information should be included in SITREPS to RCC/MRSC:

- Case number or description of case;
- Number of the situation report (e.g., first, second, eighth, etc.);
- Current date and time;
- Present status – all case details that RCC does not have, including weather conditions;
- Action taken – include all search patterns and movements since departing wharf;
- Future action includes all items that will impact on the future. Include in this section any request for air support; and
- Your signature and vessel name.

Note: All SITREPS should be written prior to transmission.

11.7.3 Communication priorities

The order of priority of radio communications is:

- distress communications;
- urgency communications;
- safety communications.

11.7.4 Release of information to the media and the public

If you are involved in SAR operations, you may sometimes be contacted by the media or the public for information. Facing them is not an easy exercise. Often the local reporters will call you first, even if they know that they should call the closest RCC/MRSC in your area. Their general objective is to have you express emotion or shocking statements for their own audience, particularly in remote stations where the crew is part of a small community. An unsuccessful search is all the more likely to affect you emotionally if the missing souls are people you know from your own town.

Coast Guard and Coast Guard Auxiliary members should follow these guidelines when dealing with the media:

- It is more prudent to respond than to give the impression of being unaware or unresponsive;
- Clearance must be obtained from the RCC/MRSC. The facts given in an interview should be limited to the following (remember to limit your answers to what you know):
 - numbers of resources engaged in the search;
 - number of crew aboard the search unit;
 - numbers of hours your unit has been engaged in the search;
 - the area searched and search results of your unit;
 - weather conditions;
 - your unit's search capabilities.
- Refer of other questions, particularly concerning decisions to carry on with the search, to RCC/MRSC;
- Personal opinions, your feelings about the outcome of the operation, the conduct of the operation or departmental policy must not be discussed. Always refer these types of questions to your RCC/MRSC.

11.8 PLANNING

All SAR missions are different, yet all SAR mission should be prepared in a similar manner. The following are the general steps involved in the planning of an SAR mission.

11.8.1 Before departure and during transit

The following should be done before departure:

- Gather all the relevant information:
 - Exact location of the incident;
 - Kind of vessel and any useful clues (colour, name, distinctive features, etc.);
 - Number of persons on board;
 - Means of communication with the distressed vessel (cellular phone, radio, etc.);
 - Any other pertinent information.
- Find the best route to reach your destination;
- Calculate your ETA;
- Bring everything you need with you. When deciding what to bring, consider:
 - Weather (raingear? warm clothes? sunglasses? etc.);
 - Expected duration of the mission (bring extra food and water if necessary);
 - Kind of incident (any special equipment needed?).
- Brief the crew:
 - Prepare short-term strategies;
 - Define priorities;
 - Assign tasks;
 - Prepare the equipment that will be needed (pumps, first aid material, towlines, etc.).

11.9 BASIC SEARCH PLANNING

Before SRUs are dispatched, careful planning is needed to accurately determine the area where the survivors are or will be located when the boat arrives on scene. Good SAR planning significantly increases the probability of successfully locating and rescuing those in distress. Planning the search involves calculating datum and then outlining the boundaries of the search area. Most search planning is done by the RCC/MRSC and results in a search action plan. The boat crew then conducts SAR operations based on this search action plan. However, there may be times where you will have to do basic search planning. Search planning also includes risk management to determine what response, if any, is appropriate and which resources are the right ones needed to respond.

11.9.1 Datum

The term “datum” refers to the most probable location of the distressed vessel, corrected for drift over a given period of time. Depending on the information available and its accuracy, datum may be:

- a point;
- a line;
- an area.

As the case develops, datum must be corrected to account for wind and current. Datum is established by the RCC/MRSC.

11.9.1.1 Datum point

A point at the centre of the area where it is estimated that the search object is most likely located. The probability of detection (POD) is maximal at that point and decreases as you get away from that point.

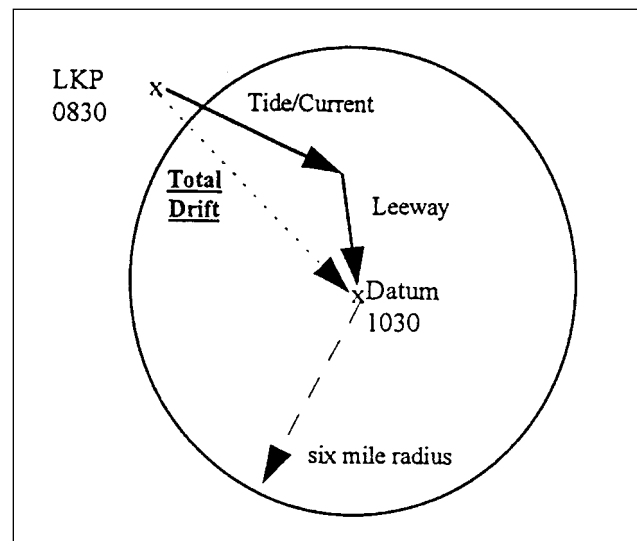

Figure 11.2: Coastal search area calculation

11.9.1.2 Datum line

If you cannot pinpoint the location of a distressed boat, you may be able to determine its intended trackline or a line of bearing. The datum line is the intended trackline or line of bearing plotted on the chart. Without more information, it is assumed that the distressed vessel may be anywhere along the length of the plot. The line could also be a direction-finding line of position.

11.9.1.3 Datum area

When you cannot determine either the exact position of the distress or a datum line, a datum area is developed based on many factors, but including as a minimum:

- fuel endurance of the vessel in distress;
- vessel's maximum cruising range;
- wind and currents which affect the search object;
- operator's intentions.

11.9.2 Forces affecting datum

As time progresses, datum must be corrected to compensate for the effects of wind and current. Some of the many natural forces which affect a search object are listed below.

11.9.2.1 Leeway

Leeway is the movement of a search object through the water. Leeway is caused by local winds blowing against the exposed surface of the vessel.

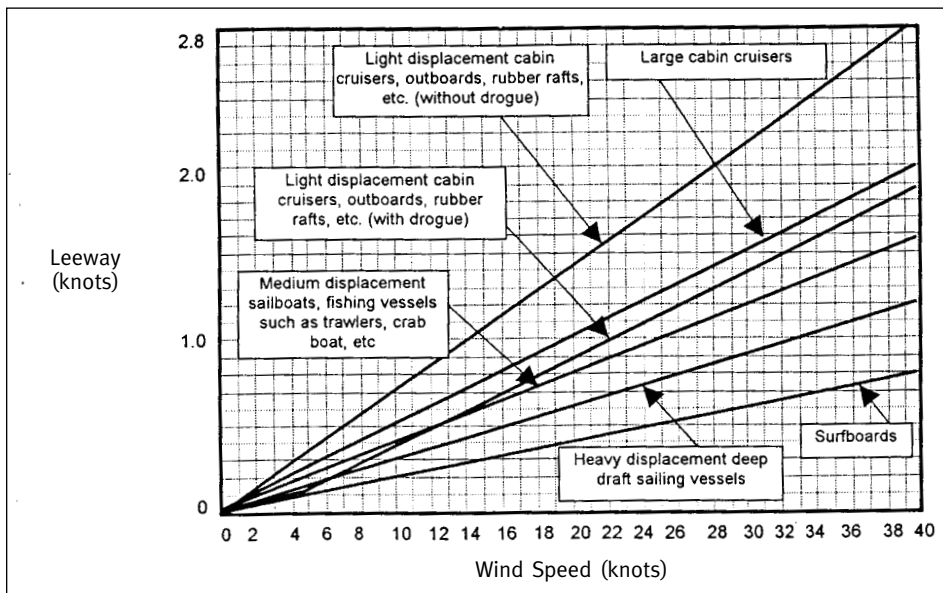

Figure 11.3: Leeway speed graph

11.9.2.2 Local wind-driven current

Wind blowing over the water's surface tends to push the water along in the same direction the wind is blowing. This wind current affects the movement of a search object in open waters. Wind-driven current may not be a factor when searching in coastal waters, small lakes, rivers, or harbours because nearby land masses may block or reduce the effect of wind.

11.9.2.3 Sea current

Sea current refers to the movements of water in the open sea.

11.9.2.4 Tidal current

Tidal current is caused by the rising and falling of tides.

11.9.2.5 River current

The flow of water in a river is called river current. These currents can quickly move a search object over a long distance. This factor should be considered in rivers or at the mouth of a large river.

Note: Drift, in search planning, is the movement of a search object caused by all of the environmental forces.

11.9.3 Search area description

The search area is a geographic area determined by RCC/MRSC as most likely to contain the search object. The amount of error inherent in drift calculations and the navigational capabilities of both the distressed craft and the SRU are used to calculate a search radius.

Note: When response times are short, RCC/MRSC may use a standard radius, adjusted for physical surroundings. When a search can begin in less than six hours, a six-mile radius around a datum adjusted for drift is usually large enough to include most search objects.

Search areas may be described by many methods, including the following:

11.9.3.1 Corner point

In this method, the latitude and longitude (or geographic features) of each corner of the search area are given.

Figure 11.4: Corner Point

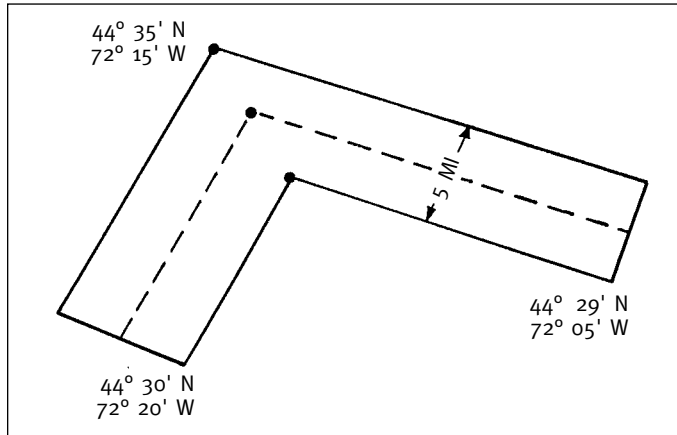
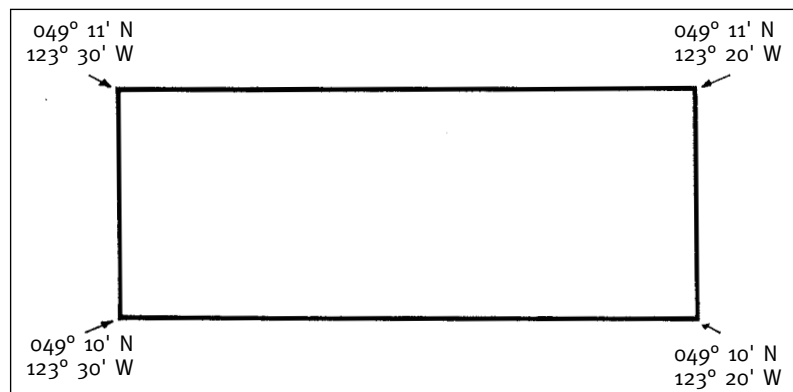

11.9.3.2 Trackline

The latitude and longitude of the departure point, turn points, and destination point are given with a specific width along the track.

Figure 11.5: Trackline

11.9.3.3 Centre point (circle)

The latitude and longitude of datum are given, along with a radius around datum.

Figure 11.6: Centre point (circle)

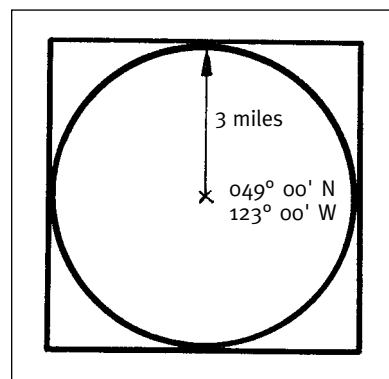

11.9.3.4 Centre point (rectangle)

The latitude and longitude of datum are given with the direction of major (longer) axis plus the length and width of the area.

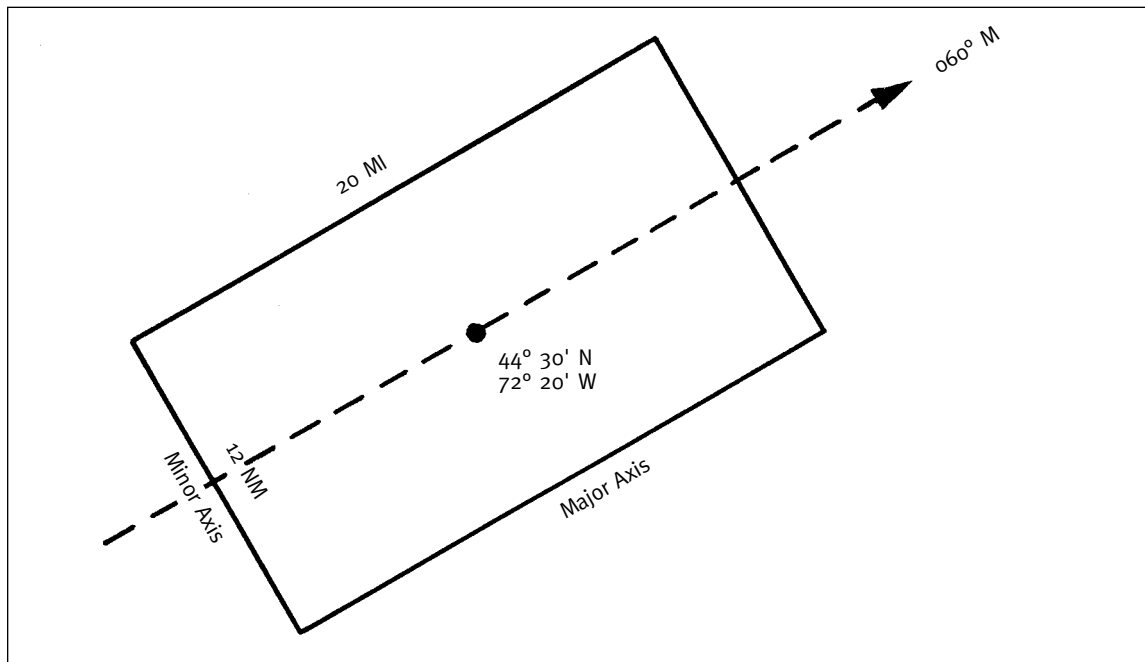

Figure 11.7: Centre point (rectangle)

11.9.3.5 Centre point-landmark (rectangle, bearing and distance)

The centre point, or datum, may also be designated by a bearing and distance from some geographic landmark.

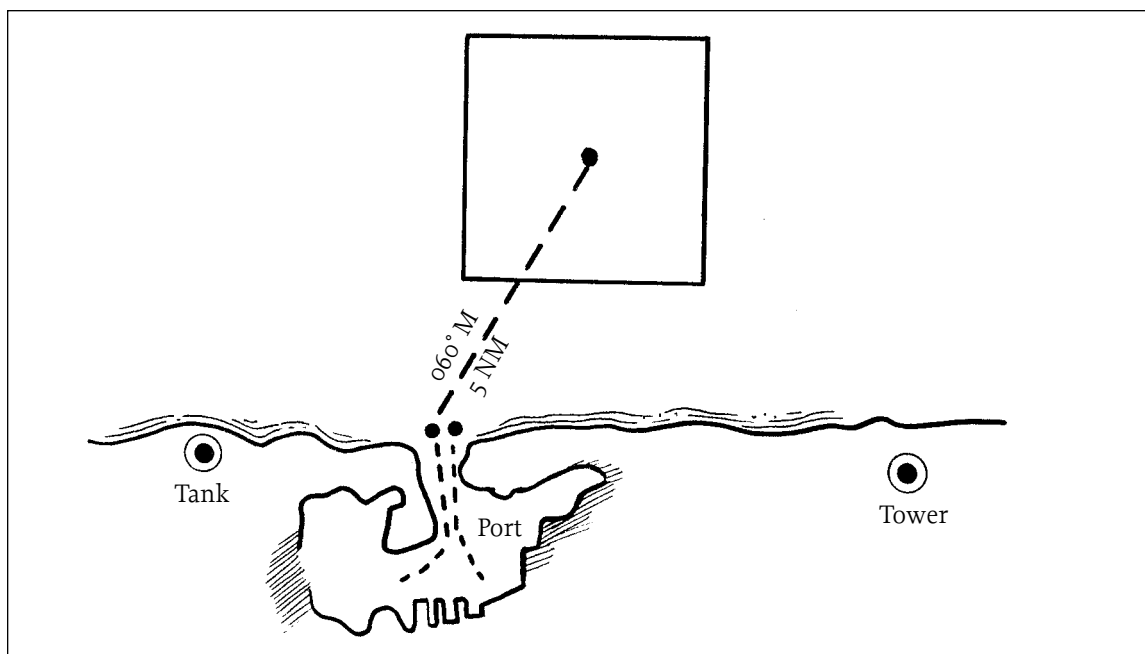

Figure 11.8: Centre point method (rectangle, bearing and distance)

11.9.3.6 Landmark boundaries

Two or more landmarks along a shoreline are given as boundaries of the search area.

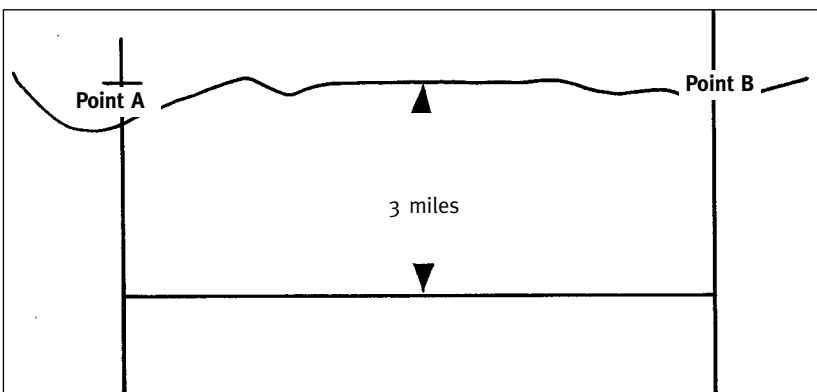

Figure 11.9:
Landmark boundary
method

11.10 SEARCH PATTERNS

Once a search area has been determined, a systematic search for the object must be planned. If you did the search planning, you will now have to determine which is the best search pattern to use. If RCC/MRSC did all the planning, they should tell you what pattern to use.

Consider the following to determine which search pattern to use:

- weather conditions;
- size of search area;
- size of search object;
- number of search units involved;
- search area location;
- time limitations.

11.10.1 Search pattern designation

Typical search patterns are designated by letters. The first letter indicates the general pattern group:

- T** = Trackline;
- C** = Creeping line;
- P** = Parallel;
- V** = Sector;
- S** = Square.

The second letter indicates the number of search units:

- S** = Single-unit search;
- M** = Multiunit search.

The third letter indicates specialized SRU patterns or instructions, for example:

- R** = Return;
- N** = Non-return.

11.10.1.1 Square patterns (S)

The square search pattern is used when the last known position of a search object has a high degree of accuracy, the search area is small, and a concentrated search is desirable.

Square Single-unit (SS)

In the SS pattern for boats, the first leg is normally in the direction of the search object's drift, and all turns are made 90° to starboard.

Square Multi-unit (SM)

The SM pattern is used when two units are available. The second unit begins on a course 45° to the right of the first unit's course.

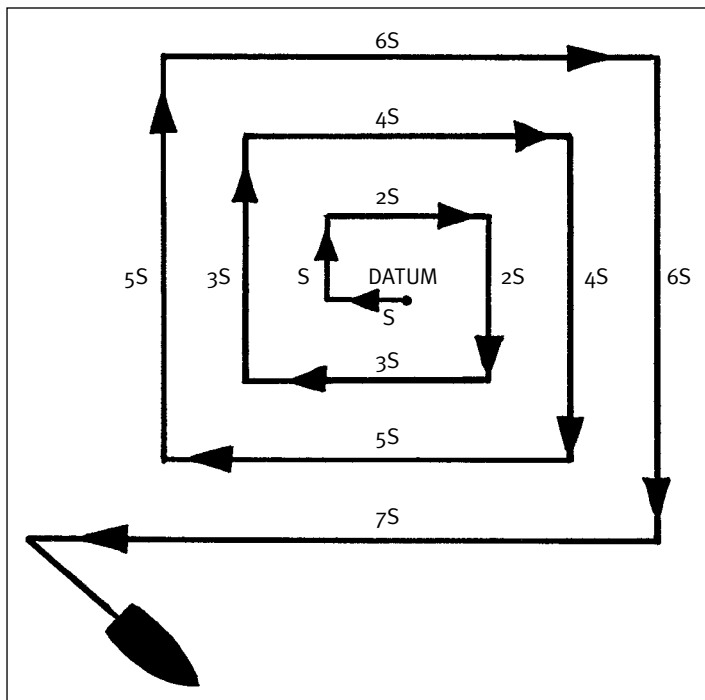

Figure 11.10: Expanding square search (SS)

11.10.1.2 Sector patterns (V)

Sector search patterns are used when datum is established with a high degree of confidence, but the search object is difficult to detect, such as a person in the water. The search unit navigates through datum several times, each time increasing the chances of finding the search object. The pattern resembles the spokes of a wheel with the centre of the wheel at datum. Datum should be marked by the first SRU on scene with a Data Marker Buoy (DMB) or other floating object. By marking the centre of the search pattern, the coxswain has a navigation check each time the boat comes near the centre of the search area (datum). This pattern consists of nine legs. There are two types of sector search patterns: a single-unit and a multi-unit type.

Sector Single-unit (VS)

The VS pattern is used by a single boat. The first leg begins in the same direction as the one the search object is drifting toward. All legs and crosslegs of this pattern are of equal length. After running the first leg, your first turn will be 120° to starboard to begin the first crossleg. All subsequent turns will be 120° to starboard to a course determined by adding 120° to your previous course. Notice that after completing the first leg and crossleg, the second and third legs of the pattern are completed in sequence without turning between.

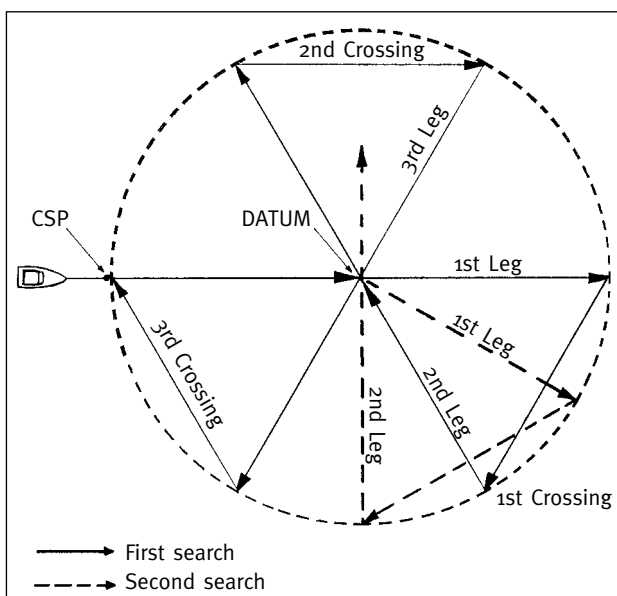

Figure 11.11: Sector pattern: single-unit (VS)

Sector Multi-unit (VM)

The VM pattern is used when a second boat is available. The second boat starts at the same datum, but begins the first leg on a course 90° to the left of the first boat. The search is then the same as a VS pattern. The second boat should start the search at a slower speed than the first boat, if both boats start at the same time. When the first boat is one leg ahead of the second boat, the second boat accelerates to search speed. This slow start by the second boat will keep both boats from arriving at the centre of the search pattern at the same time.

11.10.1.3 Parallel track pattern (P)

Parallel track patterns are used when there is a probability that the search object could be anywhere in the search area. It is a good pattern to use when the approximate location of the search object is known and uniform coverage is desired. Parallel track patterns are the simplest of the search patterns. You steer straight courses on all legs. Each leg is one track spacing from the other. The legs are parallel to the long side or major axis of the search area. There are two types of parallel track patterns.

The Commence Search Point (CSP) for parallel patterns is located at a point $\frac{1}{2}$ of the distance selected as the search track spacing inside a corner of the search area. The first and last search legs then run $\frac{1}{2}$ track spacing inside the search area boundaries. This prevents excessive duplicate coverage, eliminates the possibility of leaving an unsearched track at the search area boundary, and gives SRUs in adjacent search areas a margin of safety.

Parallel Track Single-unit (PS)

The PS pattern is conducted by a single SRU. The legs of the search are run parallel to the long side (Major Axis) of the search area.

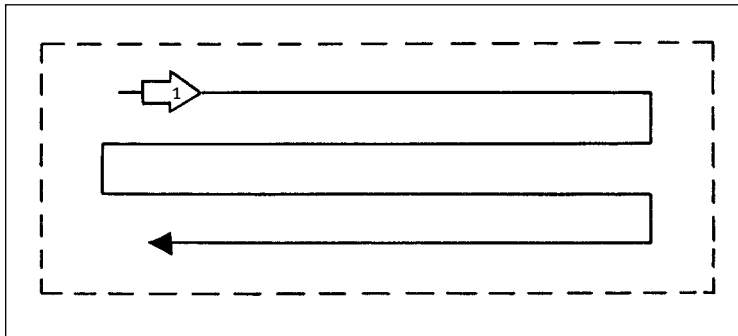

Figure 11.12:
Parallel track Single-unit
(PS)

Parallel Track Multi-unit (PM)

The Multi-unit (PM) pattern is used under the same circumstances as the (PS), but with more than one SRU. The SRUs are separated by a single track spacing. They search parallel to the long side of the search area. After completing the first search leg, they move over a distance equal to the track spacing times the number of SRUs, and then search back on the reciprocal heading of the first leg.

11.10.1.4 The creeping line single-unit pattern (CS)

The CS pattern is used when the probable location of the search object has been determined to be more likely at one end of the search area than at the other end. Creeping line search patterns are the same as parallel patterns, except that the legs are run parallel to the short side (minor axis) of the search area. This pattern's CSP and search legs are also located $1/2$ track spacing inside the search area.

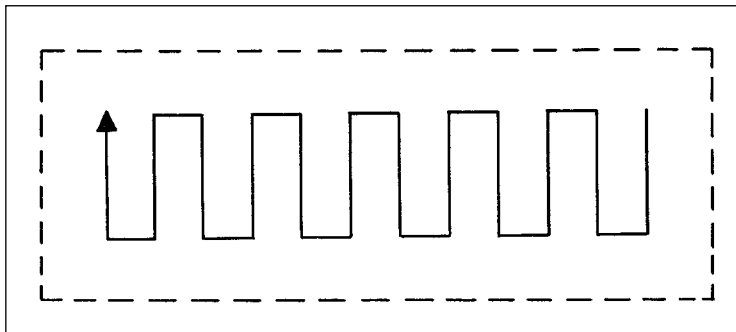

Figure 11.13:
Creeping line single-unit
(CS)

11.10.1.5 The trackline single-unit return pattern (TSR)

The Trackline Single-unit Return (TSR) pattern is used to search when the only information available on the missing vessel is the intended track of the search object.

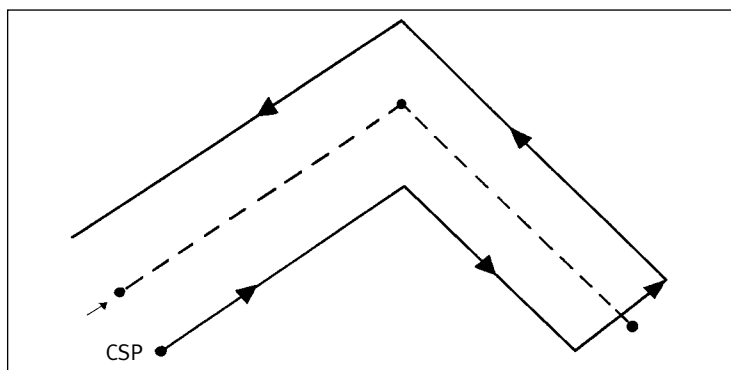

Figure 11.14: **Trackline**
single-unit return (TSR)

11.10.2 Additional search patterns

11.10.2.1 Barrier

The barrier pattern is used in areas with strong current such as a river. The search lies along the path of the current. The boat moves back and forth over the same track. This can be done by steering on an object on each side of the river bank. The boat moves from one side of the search area to the other while the current carries the water and objects past the search barrier.

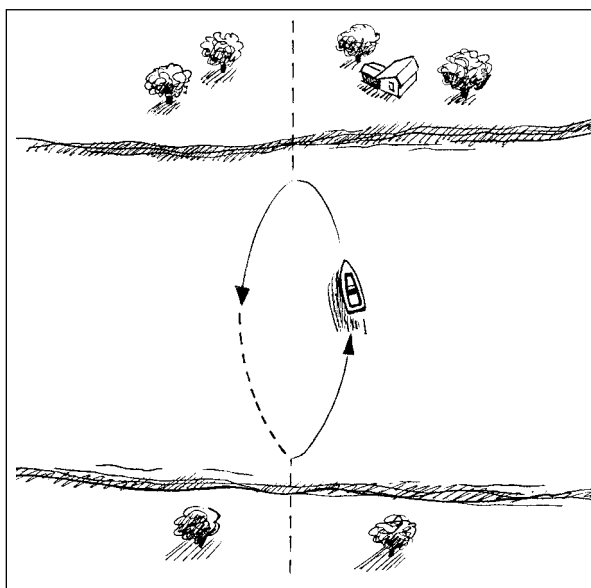

Figure 11.15: **The barrier pattern**

Since river currents can vary across the width of a river, a more effective barrier might be established by forming a line abreast. This is done by placing observers on each bank and having a boat in the area of swiftest current hold station between the observers on shore. Additional boats, if available, could be added to the line abreast to reduce the effective track spacing and increase the effective coverage. This technique produces a more effective, and predictable, barrier.

11.10.2.2 Shoreline search

Small vessels are normally used to perform the shoreline search, since they can sail close enough to the shoreline to permit careful inspection. Vessels engaged in shoreline searches must be aware of navigational constraints and any limitations imposed by sea conditions. Search planners should consider the possibility of survivors clinging to navigational aids such as buoys, or to rocks off shore. Survivors may make their way to any dry land they drift close enough to see. Survivors may also anchor their boat or raft, or tie it to an offshore navigational aid if they drift into shallow water but still cannot see land or believe they cannot make it to shore unaided.

11.10.3 Initial response

Whenever a case occurs which has an SRU on scene and the object of the distress is not immediately seen or located, report the situation to the RCC/MRSC through the quickest means possible. The RCC/MRSC will immediately start planning and then develop a search action plan. In the meantime, the SRU shall be conducting either an expanding square or sector search using a search radius of 6 NM.

11.10.3.1 Initial response search area

If the search object is not located at arrival on scene, the SRU is to assume it is adrift unless the distressed boat indicated it was at anchor.

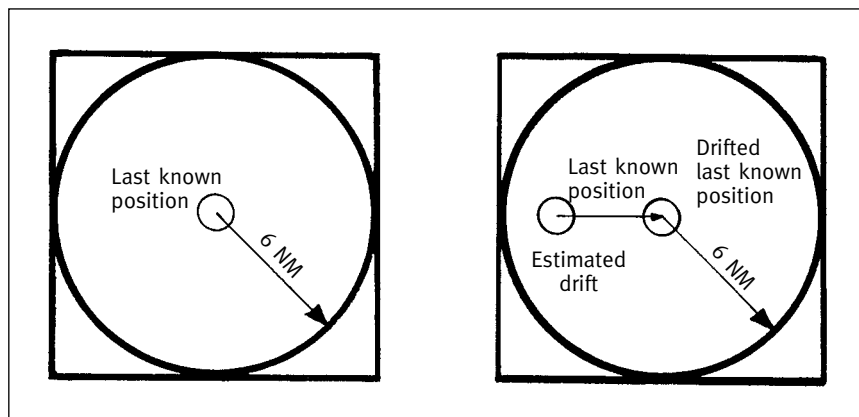

Figure 11.16: Initial response search area

11.10.3.2 Procedure

- Draw a circle with a 6 NM radius centred at the last known position (LKP). If drift is considered significant, the SRU should estimate the drift based on local knowledge/on scene conditions, and centre the 6 NM circle around the drifted LKP;
- Confirm the new datum with the SMC. Remember that the time of datum must take into consideration the underway transit times for the SRU;
- Next draw the search pattern within the tangent of the circle. Datum for the search is the commence search point (CSP). Track spacing can be obtained from the following table.

Table 11.1: Initial track spacing (NM)

Search object	Good conditions Wind < 14 knots Seas < 3 feet	Poor conditions Wind > 15 knots Seas > 3 feet
Person in water	0.1*	0.1*
Object < 15 ft. long	0.5	0.2
Object > 15 ft. long	1.0	1.0

* > 0.1 up to SRU's minimum ability to navigate.

- Orient the search area in the same direction of drift, that is, in the same direction as the total drift vector;
- If the reported position of the distressed craft is in shallow water, it could be at anchor, and a search down the drift line may be appropriate.

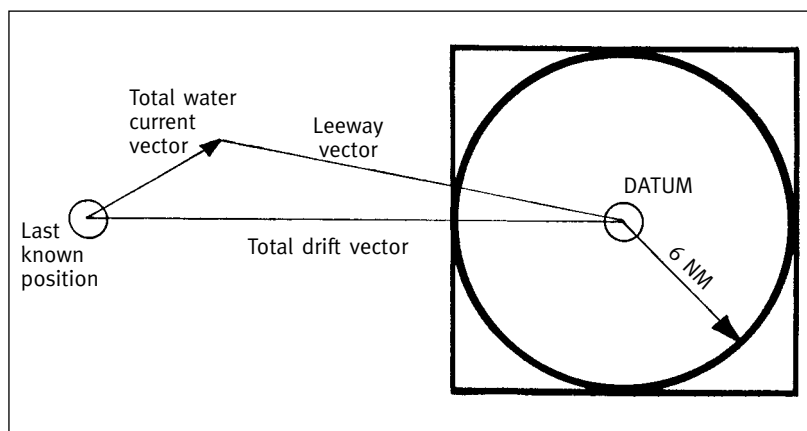
**Figure 11.17: Vessel drift**

11.10.4 Communications with RCC/MRSC

The SRU shall also keep the RCC/MRSC constantly updated on conditions and findings, and when nearing completion of initial response search. This direction should not preclude an SRU from using an alternate search pattern or area when it is clearly not practical (e.g., narrow waterway or other physical barrier).

11.10.5 Appropriate search pattern

The preestablished operations and search procedures for the first SRU on scene should be to immediately report to RCC/MRSC the on-scene conditions and findings. Next, begin appropriate search pattern.

Usually an expanding square (SS) is used. This is because it concentrates the search closer to datum, and because the RCC/MRSC usually gives direction and information for conducting and starting a first search fairly quickly. If the search area is confined or there is reason to have a high degree of confidence in the selected datum (e.g., debris found), the surface SRU may use a sector search (VS). Other search patterns may be used as appropriate.

11.10.6 Search area coverage

Search area coverage considers the area to be searched and the SRUs available to search. Once the search area has been determined and the search patterns selected, the next step is to have SRUs conduct the search. Based on the sweep width, an SRU will be assigned its own part of the overall areas to search. Essentially, your boat will start at an assigned commence search point (CSP), steer the track (search leg), and search (sweep down) on both sides of the boat.

11.10.6.1 Sweep width (W)

Sweep width is a distance measured on both sides of an SRU. A sweep width of one mile means $\frac{1}{2}$ mile to starboard and $\frac{1}{2}$ mile to port for a total “width” of one mile. Sweep width is determined by:

- search object type, size and construction;
- environmental conditions;
- sensor (e.g., visual or radar).

Sweep width is the mathematical expression of a measurement of search potential. It represents the range at which the number of dispersed targets that can be detected beyond these limits is equal to the number which could be missed within the limits. This value is thus less than the maximum detection range.

Table 11.2: Sweep width (in nautical miles)

DAYLIGHT SEARCH								DARKNESS SEARCH	
Visibility in nautical miles									
Device	1	3	5	10	15	20	30		
Red Balloon	0.5	0.5	0.5	0.5	0.5	0.5	0.5	Life jacket light	1.0
Life Raft	0.5	1.0	1.4	1.8	1.9	2.0	2.2	Hand flashlight	3.0
Boat (0-30 ft.)	0.5	2.5	2.7	3.9	5.2	5.3	5.5	Strobe light	3.5
Boat (30-60 ft.)	0.5	3.5	4.2	6.5	8.5	8.6	8.7	Hand flare	8.0
Boat (60-90 ft.)	1.0	3.9	5.0	8.0	11.0	12.0	12.5	Parachute flare	10.0

Note: Use 1/10 of the life raft width for a man in the water

Note: Estimation only in good visibility

11.10.6.2 Track spacing (S)

Track spacing is the distance between adjacent parallel legs within a search area. These tracks may be conducted simultaneously by multiple units separated by fixed intervals, or they may be the result of successive sweeps conducted by a single SRU. Most of the search patterns described in this chapter consist of equally spaced, parallel search legs (tracks). The distance between adjacent search legs is called the track spacing (S). The best track spacing is a distance which permits maximum expectation of search object detection in the shortest period of time.

11.10.6.3 Commence search point

The commence search point is a point normally specified by the RCC/MRSC at which an SRU must begin its search pattern.

11.10.7 Search preparation

Before beginning a search, you must collect all available facts about a case. The RCC/MRSC should provide most of this information as the search action plan. The checklist below will help you determine whether you have everything you need to begin a mission. Once you have collected all available facts and performed the required search planning, you are ready to get underway.

Answers to the following questions will help determine if you have done everything you need to do before getting underway:

- What is the object of this search and what equipment do the personnel aboard have?
- How many people are involved?
- What is the assigned search area?
- What are the circumstances of their distress?
- What search pattern will be used?
- What is the desired search speed?
- What special equipment is required?
- What radio frequencies will you use?
- Are other units assigned? If so:
 - What kind?
 - What are their search areas?
 - What are their search speeds?
 - What search patterns will they employ?
 - What radio frequencies will they use?
- Do you have all required charts aboard?
- What are the weather and sea conditions?
- Who is on-scene coordinator/coordinator of surface search (OSC/CSS)?
- What unusual circumstances may be encountered? How will you correct for them?

11.10.7.1 Brief crew and lookouts

Crewmembers must be briefed before getting underway. Make sure all crewmembers:

- understand the mission;
- know what they are looking for;
- know where the search will be conducted;
- understand how the search will be conducted.

The coxswain is responsible for the safe operation of the vessel, the safety of all crewmembers on board, and the supervision of lookouts. The coxswain must brief the lookouts so that they are able to perform their duties properly. The following should be considered:

- The coxswain must ensure that lookouts realize the importance of their duties. Lookouts must understand that there are lives at stake and they should search as intently as they would wish someone to search for them. Motivating the lookouts to think positively creates a good chance of success;

- Lookouts should have a full understanding of the details of the case. They should know the nature of the distress, the object of the search, and possible variations to the scenario;
- Caution lookouts to be alert for audible signals of distress such as a whistle or shouting, particularly at night;
- Assign the lookouts a sector of the vessel to search from, and explain the track spacing of the search. Some guidance as to how far from the side of the vessel they should search can be given at this time;
- Instruct lookouts on how to search the area and how to delay fatigue and maintain interest;
- Keep the crew informed of updates and progress of the search including the activities of other units involved in the search;
- Instruct lookouts on the preferred method of reporting a sighted object. The reports should be continuous until the coxswain has sighted the object;
- The coxswain should always confirm to crewmembers the sighting of the object reported.

As the supervisor of the lookouts, coxswains should ensure proper rest for the lookouts. Light refreshments should be on board for the lookouts during their rest periods. Light conversation between lookouts should be encouraged as a means of keeping them alert, but conversation should not detract from their main duty.

11.10.7.2 Search object briefing

Before arrival at the search area, the coxswain of the search vessel should brief all lookouts as to the nature of the distress and the object of the search.

Lookouts should be informed of the nature of the distress. This brings the lookout into the overall picture and establishes the reason for the search. Most searches are the result of an overdue vessel, and the lookout should understand the types of situations the craft may have encountered.

In the marine environment, there may be uncertainty regarding the precise object of the search. The search object may have commenced as a 12 m (40 ft.) vessel but shifted to a life raft or to people in the water. Ensure that all lookouts understand these possibilities.

11.10.7.3 Lookout assignments

The coxswain of the search craft has many duties to perform, including the safe navigation and control of the vessel, communications and plotting. As well, the coxswain must attend to the general supervision of all lookouts. Consequently, she/he cannot devote attention to searching the water surface with the degree of concentration required by a lookout.

The coxswain of the search vessel should not take on any lookout duties except those relating to the safe navigation and control of the vessel, unless numbers of lookouts dictate otherwise.

The coxswain of the search vessel should ensure there are enough crew aboard to conduct an effective search. The minimum number of crew is two, one searching to starboard and one to port. An additional crewmember is desirable to relieve the lookouts and the helmsman, if possible. Sufficient lookouts permit a relief rotation system, thus allowing each an opportunity to rest their eyes between periods of lookout. Even a change of sector may require a rest, given the differences in wind and light conditions.

11.11 CONDUCTING A SEARCH

It is critical that an SRU perform all duties assigned in a correct and predictable fashion. In this case the term SRU includes the vessel, crew, and equipment. Search planners, OSCs/CCSs, RCCs/MRSCs and others all make plans based on assumptions they have made. These assumptions are considered when making decisions that could have life and death consequences for someone who may be the object of a major Coast Guard search effort. One assumption made by SAR planners is that the SRU, its crew, and equipment all perform as planned, completing all missions assigned unless advised otherwise.

In some instances, SRUs have failed to properly complete their assigned mission. Reasons may include not having proper equipment on board, or a crewmember not fully prepared, trained, or qualified, or a failure to complete some task. There have been instances when an SRU failed to fully search an assigned area or, due to careless navigation, failed to search in the area assigned. Actual searches and rescues are typically carried out when conditions are at their worst, making even simple and routine tasks extremely difficult. Accurate navigation, observant lookouts, and trained and knowledgeable crewmembers can make the difference between successful cases and disasters.

All effort expended to carefully gather key information, to plan the most effective search, or select exactly the right SRU is wasted if the SRU performing the search or rescue fails to do so in a professional manner to the best of its ability. If you are not able to complete the search (e.g., equipment failure, poor visibility or worsening weather), advise the RCC/MRSC what areas were searched.

11.11.1 Visual search procedures

Be conscious at all times that there is no one else scanning your search sector. You have a heavy responsibility to stay alert and to be thorough. A lookout should use the proper equipment, have a methodical

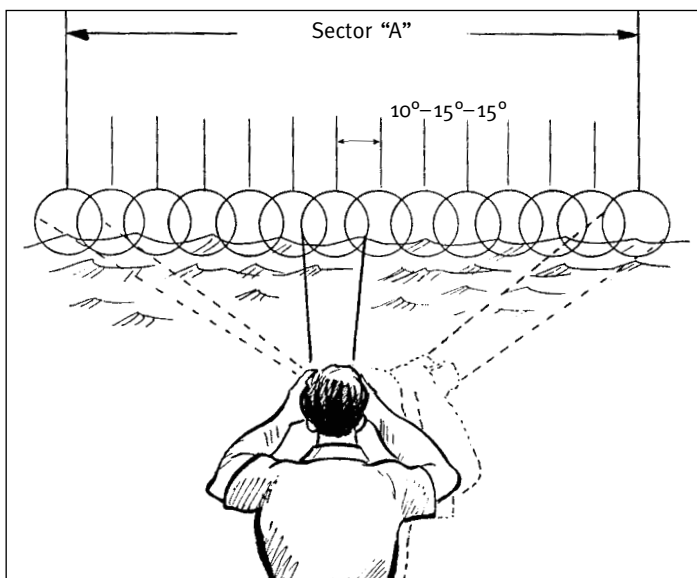

Figure 11.18:
The SCAN-FOCUS-SCAN technique

approach to searching, and be able to report any sightings within the assigned sector to the search vessel coxswain in a clear manner.

Use a methodical approach to searching an assigned area. Begin to search the assigned sector by starting a sweep near the vessel and working out in a series of parallel lines to the edge of the search sector. When you have completed the sweep, give your eyes a five to ten second rest. Then begin another search of your sector.

With the eyes focused straight ahead, the lookout should move his/her head to search the assigned area. Searching an area using eyes alone, without any head movement, can lead to an overexertion of the eye muscles, causing early fatigue.

The sequence of "SCAN-FOCUS-SCAN" should be performed in segments of 10-15°, as this technique allows your eyes to register objects within an 8° radius around the focused position. If you scan continuously without focusing, or focus beyond the 15° limit, efficiency decreases.

In night searches, weak lights are detectable at the edge of sight, not at the point of focus. Consequently, focus slightly higher than the horizon and be alert for distant flares or other visual distress signals.

It is usual for a person to take up to 30 minutes or more to become fully adapted to night-light. Therefore, avoid glare and reflection on board in order to preserve night vision.

Relate the speed for searching the assigned area to the speed of the search platform. The faster the search vessel proceeds through an area, the faster you have to search the sector.

Sunglasses should be used when scanning up-sun, and are recommended for continuous use during searches in bright daylight or high glare conditions. Sunglasses that filter rays from the infrared and ultraviolet spectrum provide proper eye protection.

Binoculars should not be used for scanning. Once an object has been located, binoculars may be used to identify it. Binoculars should be kept clean and readily available to the lookout.

Rotate positions every half-hour with increased frequency during poor or dull weather. In good conditions, you will be effective no more than two hours without rest. After this time, your concentration will deteriorate rapidly, and the vessel will become less effective as a search unit.

Maintain eye contact with any sighting. Attention should be attracted through a pre-arranged method of reporting by hailing, intercom, or other means. At no time should eye contact with the sighted object be lost while notifying the coxswain.

11.11.2 Locating the search object

Whatever the search object may be, the initial sighting of all search objects must be reported to the RCC/MRSC. The initial report will often be brief, because of the lack of information on approach, but should include:

- a description of the search object including the number of persons sighted;
- the location and on-scene weather;

- any special problems anticipated in approach or recovery;
- need for additional resources; and
- your intentions.

After the initial sighting, and while still approaching, the coxswain must continue to evaluate the situation, while formulating a rescue plan (SAP). Assessing a rescue situation is a continuous process of evaluating existing conditions. It is more than just a single step in an operation, because the assessment is never complete until the situation is under control. Communication between the crewmembers at this phase is extremely important. The coxswain must inform the crew of his or her rescue plan (and, preferably, an alternative or contingency plan). Crews must quickly prepare any required equipment or rescue devices.

The coxswain must continue to keep the RCC/MRSC informed of developments throughout the rescue phase and, in particular, the number of persons recovered and/or still unaccounted for.

11.11.2.1 Locating surface craft

A marine distress often involves a vessel still afloat but in need of assistance. In good weather and sea conditions, larger vessels are normally good visual and radar targets. Small surface vessels are usually more difficult to detect by either visual or electronic means. The best detection aid during good visibility periods is an alert lookout.

The probability of detection of even large vessels in rough seas is greatly over-estimated by many searchers. In some cases, large vessels are not detected until the SRU is close. Small craft are usually extremely difficult to detect under such conditions. In many instances, search aircraft have flown directly overhead without sighting them. At night, if the disabled vessel has the ability to turn on lights, the probability of detection is increased. When radar is used in the search for a distressed vessel, adverse sea conditions may interfere with radar and hamper identification of the target. When searching, lookouts should be alert for pyrotechnics, lights, smoke, or visual signals of any type or colour. When a possible rescue craft is sighted or heard, survivors will usually grab the closest signaling device available. Lookouts should also be alert for shouts, screams, or whistles from the survivors, as they may see the rescue craft before it sees them.

If a single distressed vessel has foundered prior to the arrival of rescue units, the most probable search objects will be lifeboats, rafts, debris, oil, and people in the water.

The scene of a major incident is usually marked with considerable debris. Often an oil slick is present. The debris will usually be found downwind of the origin of the oil slick, and boats and rafts will usually be downwind of the debris. Persons in the water are often found in the area of the debris clinging to floating objects. If the vessel was abandoned sometime before sinking, lifeboats, rafts, and personnel may be located upwind of the point of the foundering. Because of this, SRUs should search in all directions from the oil and debris area.

Lifeboats from large vessels are usually equipped with ample pyrotechnic and visual aids, and may carry emergency radios. Many also have power and/or sail propulsion. If more than one boat is launched, they might be grouped or tied together to make sighting easier. Dinghies or rafts for small craft usually have only a limited supply of visual detection aids, and in many cases do not have any.

Remember that vessel operators who are in distress are often disoriented. Be prepared to ask the types of questions that will assist you in determining the correct position of the distressed vessel. You may obtain valuable clues to its whereabouts by asking the vessel operator what he or she can see in the way of prominent landmasses, navigation aids, other vessels, or aircraft. By asking the operator to determine the bearings of such objects, you may be able to cross-reference these observations with your charts, and thus considerably reduce the search area.

Ask the operator what depth of water the vessel is in. The answer may enable you to ascertain a fathom line to follow for search purposes.

In darkness you may request the distressed vessel to fire a flare or to use some other type of illumination for you to observe (such as a searchlight). If such equipment is not available to the distressed vessel, you may use your own flares so that the distressed vessel can give you a reciprocal bearing. Whenever flares are used to obtain bearings or for illumination purposes, RCC must be advised.

11.11.2.2 Locating overdue vessels

Contact marina managers to see if the missing vessel has been in the area. If so, find out when they were there, when they left, and where they were going. (Boaters change their plans and forget to tell anyone, but may have mentioned alternate plans.)

Contact all marinas in the area to see if the vessel has docked somewhere other than the original destination. Check every vessel carefully for license number, description, and name. REMEMBER, there is no time limit on a search. It is not a race, and the watchword is thoroughness.

The vessel description may not always be accurate. Check each boat closely. There have been cases where the search has been for a pleasure craft, and the boat turned out to be a sailing vessel or a fishing boat.

Check the parking lot for the missing person's vehicle (assuming they have one). If the vehicle is still there, the person may not have returned yet. If the vehicle is not there, then the person may have returned and not told anyone. Relay this information to the CGRS by radio or RCC via landline.

Check all over the marina and floats. The missing party may have returned and tied up at a different spot than expected.

If there are other people around on the floats, tell them who you are and what you are doing. You may receive unexpected information concerning the whereabouts of the missing vessel.

Always do a thorough check of the area that the vessel departed from. Some people reported as overdue never actually began their journeys. Remember, they may have been reported overdue because they have simply not arrived at their destination.

11.11.2.3 Locating disoriented or lost vessels

This type of incident involves anything from a full-scale search to simply contacting the vessel (if possible) to ascertain their heading, course, and speed before they became lost. If possible, the vessel might relay the relative bearings of passing ships, aircraft, prominent landmarks, and the depth of the water in the area.

At night, a lost vessel could fire flares, flash navigation or searchlights, and use sound signals. You may also fire flares, and flash your navigation lights to get a relative bearing from the subject vessel. If VHF communications are established, MCTS may assist by Direction Finding (DF), or by providing positions of unidentified radar targets.

This is a “Sherlock Holmes” type of situation where the searcher must rely on information from the subject vessel, including the provisions of signals. Use your ingenuity and common sense at all times.

Note: Any time a flare is fired in order to establish bearing, rcc/mrsc must be advised.

11.11.2.4 Locating abandoned vessels

Treat abandoned vessels as though there might be a person or persons overboard or in a raft or dinghy close by. Check all circumstances and available information carefully. Often the vessel has broken or been cut free from its moorings. But, if it is full of fishing gear with lines out, someone is probably missing.

Always advise RCC/MRSC of the position and circumstances of an abandoned vessel. If any doubt exists, begin an Expanding Square or Sector Search. Use the vessel as datum and continue searching until RCC/MRSC advises further action.

11.11.2.5 Locating distressed aircraft

With the exception of seaplanes, aircraft usually sink rapidly after ditching, and the only objects normally found are pneumatic rafts and pieces of debris. If the aircraft has crashed rather than made a controlled ditch, there may be nothing more than an oil slick. Large aircraft flying over water have an adequate supply of life rafts, visual aids, and emergency portable radios. The rafts in transport aircraft are, for the most part, the large 20-man type. In military aircraft, the 7-man type is still in wide use, as well as the 20-man type. Single-engine military aircraft will usually be equipped with a one or two-man raft. Small civilian aircraft will probably carry only the one-man life raft if they carry any at all.

11.11.2.6 Locating person in the water

Locating a person in the water can be a difficult task due to sea state, weather conditions, time of day, and most importantly, absence of a flotation device. If the person is not wearing a flotation device, in most instances all that will be visible is the head. If they are wearing a flotation device, the head and shoulders will probably be visible. Be on the lookout for floating debris. The missing person(s) may be clinging to the debris.

11.11.3 Foundered or sunken vessels

If the search object has been located after it has sunk, follow these general guidelines:

- Deploy a DMB;
- Inform RCC/MRSC of the location, depth, and evidence of the sunken vessel;
- Commence a search for survivors;
- If survivors are located, determine whether any others may be trapped in the vessel. If trapped persons are suspected, request divers;
- If an emergency position-indicating radiobeacon (EPIRB) is found, do not recover it. Leave it to mark the position.

11.11.4 Search reduction

RCC/MRSC is the only authority that can recommend the reduction of a search. In certain circumstances, the decision is then relayed to NDHQ, which can either approve or deny the recommendation.

The OSC/CSS may make a recommendation for reduction of the search only after the search area has been adequately covered and there is no likelihood that survivors will be recovered. To make the reduction decision, RCC/MRSC needs to have a complete list of facts from the SAR crews involved. These facts include:

- all important times (time on scene, time search commenced, etc.);
- the weather and especially the visibility in the area;
- the area covered in each search and the type of search;
- all sightings of debris and other objects in the water;
- other relevant information such as crew fatigue; and
- any change in any condition on scene (change in wind direction, increased wave height, etc.).

The above facts should be relayed to the RCC/MRSC, as applicable, with the regular sitreps.

11.11.4.1 Cessation of searches

The ending of a search is looked upon as a reduction in the search. Searches may be reopened whenever new evidence indicating that survivors may be located is uncovered.

11.12 RESCUE

Once the search object has been located, you will have to begin the rescue part of the mission. The prime objective of all rescue operations is to ensure the safety of human life. Rescue operations begin when the search object location is known, and includes all actions taken to free persons from suffering, injury, or death.

It is obvious that no two rescue situations will be alike in all respects. Each situation must be evaluated by the rescue crew to determine the strategy and tactics required to bring about a successful conclusion. However, some procedures can be standardized to a certain extent with due regard to the variables of sea, weather, geographic location, and physical characteristics of the disabled craft, persons, and the rescue vehicle.

11.12.1 Arriving on scene

When arriving on the scene:

- advise RCC/MRSC of your arrival on scene;
- SAP (Stop, Assess and Plan):
 - persons in the water?
 - vessel's position;
 - direction of wind and current;
 - best approach angle;
 - lines in the water;
 - good securing points;
 - any obstructions on vessel;
 - general condition of the vessel;
 - modify or adapt your short-term strategies if needed;
 - determine closest safe haven;
 - assign duties to crewmembers.
- recover all PIW;
- board the vessel in the most appropriate manner:
 - instruct the crew of the vessel to don PFDs;
 - discuss your plans with the master of the vessel in need of assistance;
 - ask the master to sign the waiver.
- advise RCC/MRSC of your intentions;
- provide the required assistance.

11.12.2 Recovering persons in the water

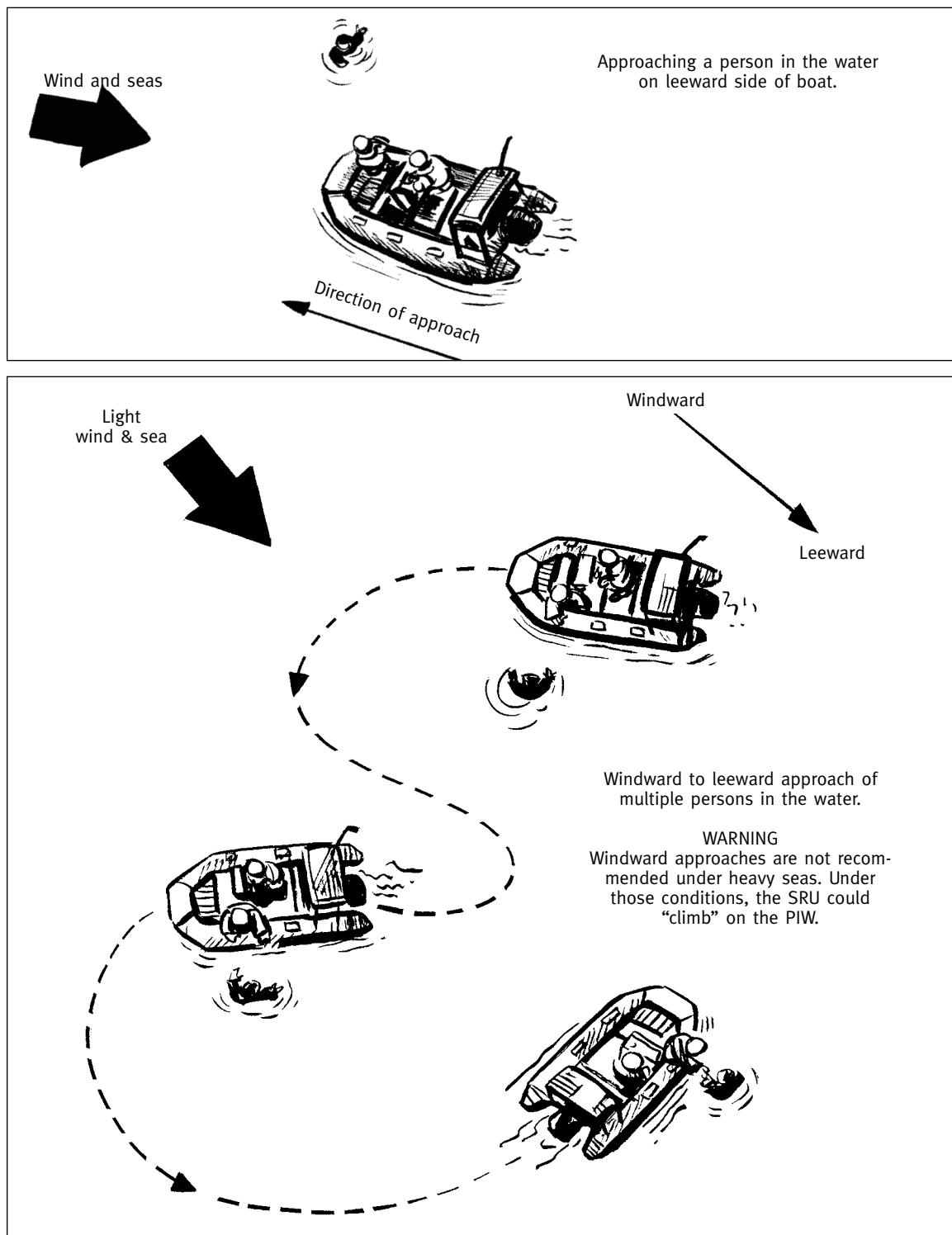

Figure 11.19: Approaching a person in the water

WARNING

Recoveries of persons in the water are delicate operations. Inappropriate techniques could cause serious injuries.

11.12.2.1 General guidelines

The crew must be briefed of the coxswain's intentions for the method of recovery and maintain situation awareness at all time. All required equipment should be prepared in advance (e.g., blankets, hot packs, Heat Treat, ladders, tender, scramble nets, rescue frames, etc.).

The system for approaching a person in the water should be well-known to all crewmembers, because it is exactly the same as person-overboard recovery operations (which should be practiced regularly by every vessel engaged in SAR). A pointer must be designated and endeavor to always keep the person in the water in sight. The pointer will position himself or herself in visual and verbal contact with the coxswain and direct him or her to the person until the person is alongside the rescue zone. The coxswain manoeuvres into position under the guidance of the pointer and stops the propellers upon approaching the person. The pickup person or team takes direction from the coxswain regarding the pickup side, and positions itself to aid the person out of the water.

People immersed in cold water will rapidly lose muscle strength and coordination, and may not be able to help themselves. They may have to be assisted every step of the way to recovery.

Normally, people in the water receive the highest priority. Seconds count, but bear in mind that suspected hypothermia victims should always be recovered gently and horizontally to reduce the chance of rapid blood pressure drop.

The general guideline for PIW recovery are as follows:

- Recover those persons who are without flotation aid before those with flotation;
- Recover those without hypothermia protection before those with hypothermia protection;
- Interview all survivors at the earliest opportunity to determine whether others are in the water and were seen;
- In cases of locating numbers of people in the water, provide temporary flotation during recovery operations (life rings, life raft, utility boat, etc.);
- Treat all immersed victims for hypothermia;
- Do not leave the scene until you are sure that all survivors have been recovered and the RCC/MRSC concurs.

11.12.2.2 Methods of recovery

Two broad categories of recovery methods exist. Direct methods involve direct contact between the rescuers and the victim, while indirect methods involve the use of various devices to assist the recovery. Since direct methods are often more hazardous to the rescuers, indirect methods should be used first. When all indirect methods have failed, use direct methods to conclude the recovery. When you need to rely on a direct method, ensure that the crewmember attempting the recovery is familiar with possible hazards (panicked victim grabbing the rescuer, cold water, etc.) and have him or her properly dressed for the job (cold protection, fins, swimming goggles if necessary, etc.).

Indirect methods to recover persons in the water involve the use of various piece of equipment. The usual methods of recovery generally involve the use of:

- floating objects;
 - throwing bags;
 - life buoy;
 - any buoyant line.
- rescue frames and Jason's ladders;
- Man Overboard Rescue System (inflatable platform);
- ladders;
- fishing nets;
- etc.

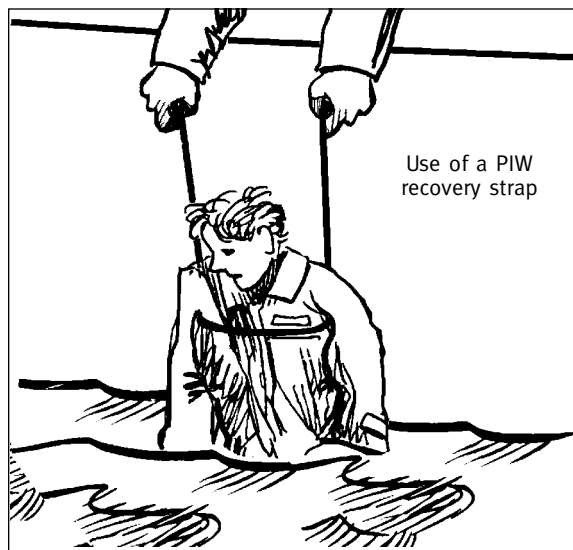
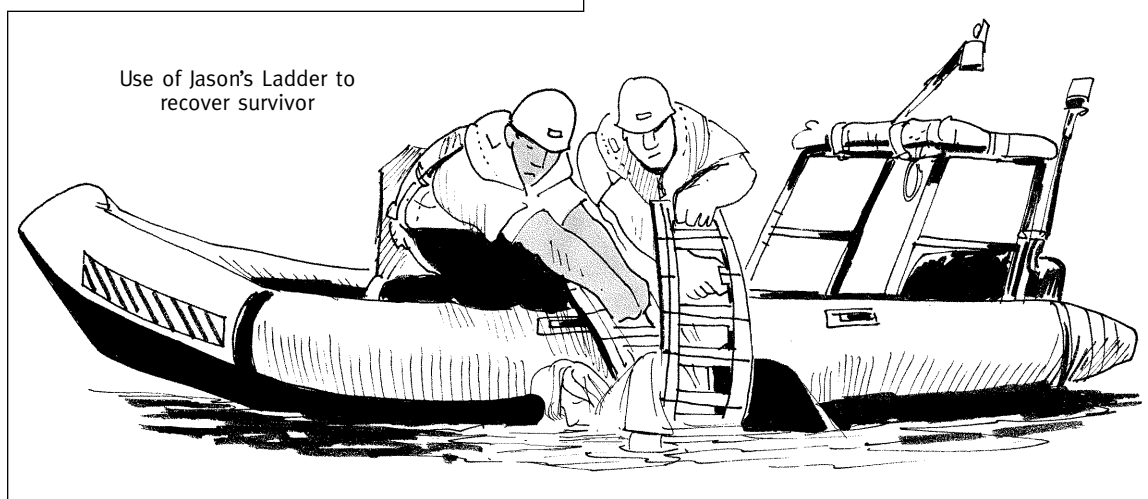

Figure 11.20:
PIW recoveries



11.12.3 Rescue of persons from burning vessels

Burning vessels present a difficult situation for SAR crews. The problem must be dealt with on the basis of elimination. The first priority is to save lives. The second is to prevent the fire from endangering other vessels or third parties, and the third is to reduce property damage. A small SAR crew is limited in its ability to save persons from a burning vessel and go into a fire-fighting mode to extinguish the fire and save the burning vessel. Complete emergency systems, including fire departments, emergency health services, and police may accomplish this task ashore, but an SAR crew of three or four cannot be directly compared to such a system. Often, when the lifesaving aspects are dealt with, the victims must be treated and evacuated to medical care, leaving the vessel to continue burning.

WARNING

The coxswain must be aware of the unit's limitations, and in particular, know when to call off an operation. All fire-fighting operations are inherently dangerous. Any fire-fighting

attempt must take into consideration the limited training and equipment provided to SAR crews for this purpose.

Crews should avoid entering burning vessels at all cost. If you do enter, do it only if there is a possibility of rescuing victims and only if proper protective gear is available. If all persons are accounted for, any fire fighting operations to reduce property damage should not include entering the vessel until the fire is out and the situation is at the overhaul stage.

SAR crews must exercise particular caution when attending a burning gasoline-powered craft. If the gasoline vapours have not already ignited by the time the SAR craft is on scene, the risk of gasoline vapor explosion will be very high. Rescue efforts must be concentrated on securing the safety of the persons aboard. DO NOT EXPOSE THE SAR CREW TO TOXIC FUMES OR RISK OF EXPLOSION FROM COMPRESSED GAS, PROPANE, ETC.

11.12.3.1 Guidelines

The following are general guidelines for rescue from a burning vessel at sea:

- The first task is to establish the safety of all persons aboard. Rescue persons as you see them and in order of greatest peril (i.e., from the vessel or in the water based on who appears most endangered). Establish the number of persons on board and whether they are accounted for. If the fire is very small, putting a crewmember aboard to search for victims may be appropriate. If approaching the vessel for transfer, approach from upwind, and if possible, conduct personnel transfers bow to bow. If a crewmember boards, all protective clothing and equipment must be worn, and communication maintained between the coxswain and crewmember boarding;
- When transferring personnel bow to bow, ensure that the transfer will be done quickly and effectively. Ideally, you should ask the crew of the burning vessel to regroup on the bow and conduct only one transfer (if boat sizes permits). Remember that you are in a very vulnerable position and that your own lives could be at risk if an explosion was to occur;
- If the bow-to-bow approach is impossible, advise the crew of the burning vessel to don PFDs and protective clothing (if available) and ask them to jump in the water;
- People in the water will generally be found on the upwind side of a burning and drifting vessel, as the wind will tend to push the vessel faster than the persons in the water;
- Use appropriate techniques for the search and rescue of either victims in the water or persons on the vessel. The latter may require an aggressive attack on the fire;
- After all victims are accounted for and secure, proceed with first aid and evacuation as required. If there is no requirement for first aid or evacuation, the fire may be fought to reduce property damage, but the SAR crew should not be placed at risk. In some cases, the vessel is best left to burn, particularly in the case of smaller vessels, which are often totally destroyed within minutes. However, in situations where the burning vessel is in a confined area that may jeopardize other structures or vessels, or block channels, etc., towing the vessel clear of the area may be required. It may also be appropriate to tow a burning vessel clear of a fishing bank, as it may become a hazard for fishing trawlers.

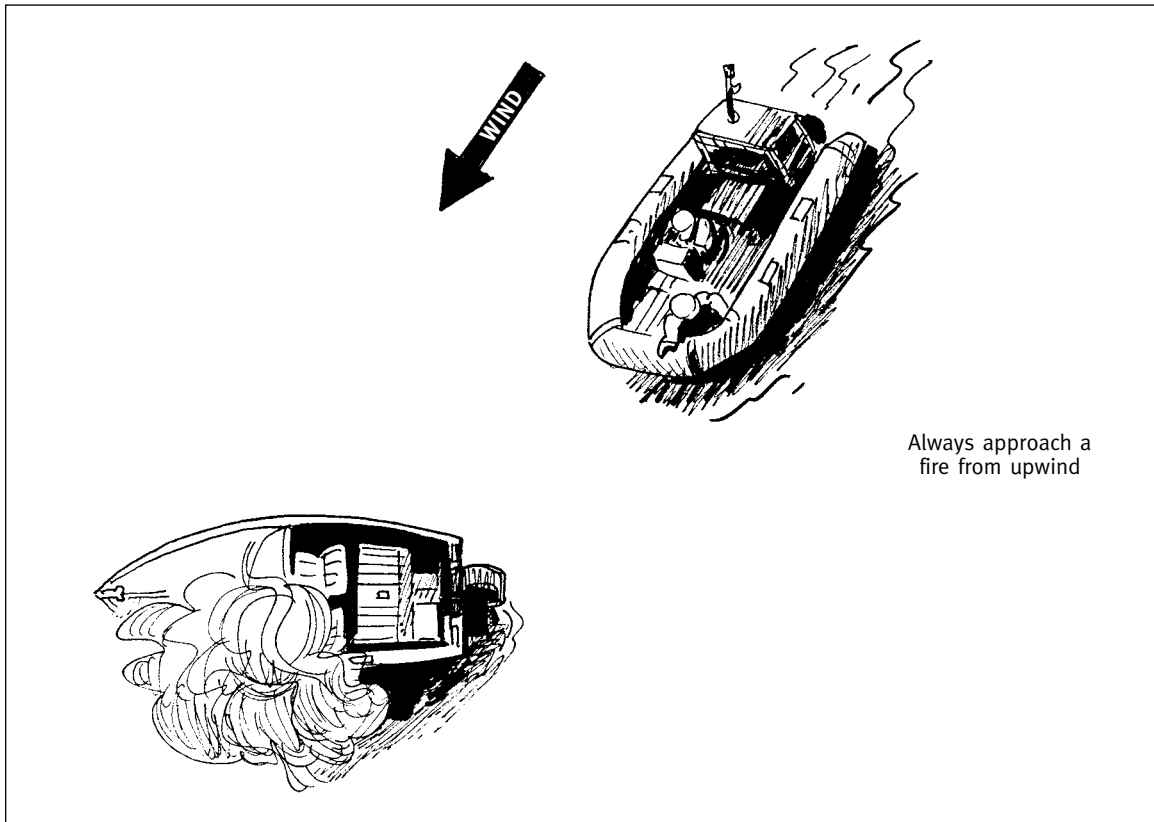

Figure 11.21: Approaching burning vessel

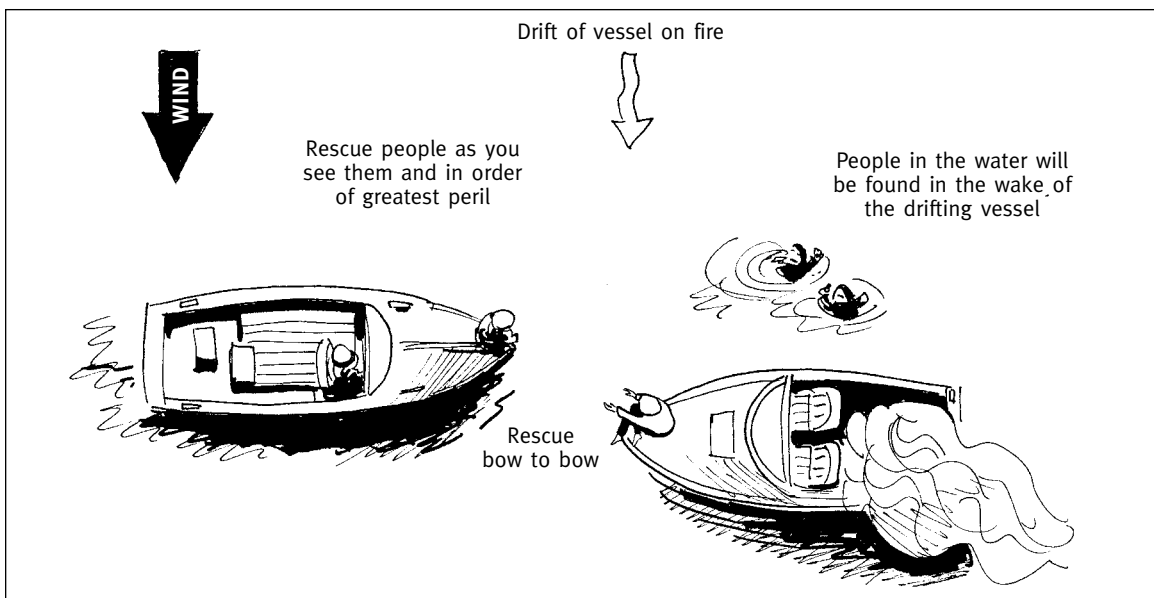

Figure 11.22: Bow-to-bow transfer

11.12.3.2 Vessel on fire at fuel docks and marinas

Vessels may catch fire while secured to fuel docks and marinas, exposing persons and other property to danger. The first task as always is to save lives and reduce injury, even though the fire may rapidly spread and destroy adjacent property.

The following are general guidelines for responding to vessel fires at fuel docks and marinas:

- Ensure that all persons from the vessel and immediate surroundings are accounted for;
- Explosions often throw people from the vessel into the water or onto adjacent vessels and structures. Check the vessel and surrounding areas for victims;
- Towing the burning vessel away from other vessels and structures is often necessary to protect property. Often, when an SRU arrives on scene, people have already slipped the vessel and pushed it off. This can have drastic consequences if the vessel drifts into others and spreads the fire further. The safest method of removal is to throw a grapnel hook and chain aboard the vessel and tow into clear water, where the fire may be attacked or allowed to burn out. Always have a crewmember ready to cut the towline when towing a burning vessel should it sink or endanger the SRU;
- If the burning vessel cannot be removed, remove other vessels that may be in danger of fire spread. Cool exposures with a fog fire stream;
- Do not endanger crewmembers by entering burning vessels that have no persons to be rescued aboard. The fire may be attacked from outside the vessel.

11.12.4 Rescue from survival craft

Rescue from survival craft may involve dealing with life rafts, open lifeboats, enclosed lifeboats, or any of a number of types of survival capsules. Rescue and transfer of personnel may be complicated by the physical condition of the survivors and the physical characteristics of the survival craft. Modern, totally-enclosed survival craft are designed to provide an optimum survival platform, and are often not conducive to sea-kindly riding and manoeuvring. Many of the enclosed survival craft are very buoyant by nature of their construction, and have an extremely lively motion at sea. Each situation requires careful evaluation before approaching the survival craft to determine whether:

- immediate removal of personnel is safe or required;
- standby is required to await improvements in weather/sea conditions or removal by other means (such as helicopter); or
- towing the craft without removing personnel is safe and appropriate (e.g., enclosed survival craft).

There have been cases of survivors found safe in a survival craft only to be accidentally rammed in heavy seas by their would-be rescue ship trying to manoeuvre alongside. Modern enclosed survival craft can safely and effectively maintain survivors in relative protection for long periods of time. In some cases, there is no need for immediate removal of personnel from the craft.

Some survival craft are self-righting with all hatches sealed and all personnel strapped into their seats. These boats are capable of operating at full capacity and at six knots for a period of 24 hours. Boats for tanker vessels will have a self-contained breathing air supply together with water spray coverage for the exposed hull, and can operate in fire or a toxic atmosphere safely for a period of ten minutes. The hatches on these craft are very small in order to accommodate both the self-righting and fire survivability features. However, the small hatches also make transfer of personnel difficult. Transfer of injured or sick personnel may be extremely dangerous in even a moderate sea.

Approaching survival craft in a seaway may require the SRU to get close enough to remove personnel or to pass a line to the craft. The lee provided by a vessel is approximately triangular in shape and extends about one and one-half ship lengths downwind at its farthest point. The exact size and shape of this lee will depend on the freeboard, length, and shape of the vessel's house works.

Figure 11.23: Survival craft

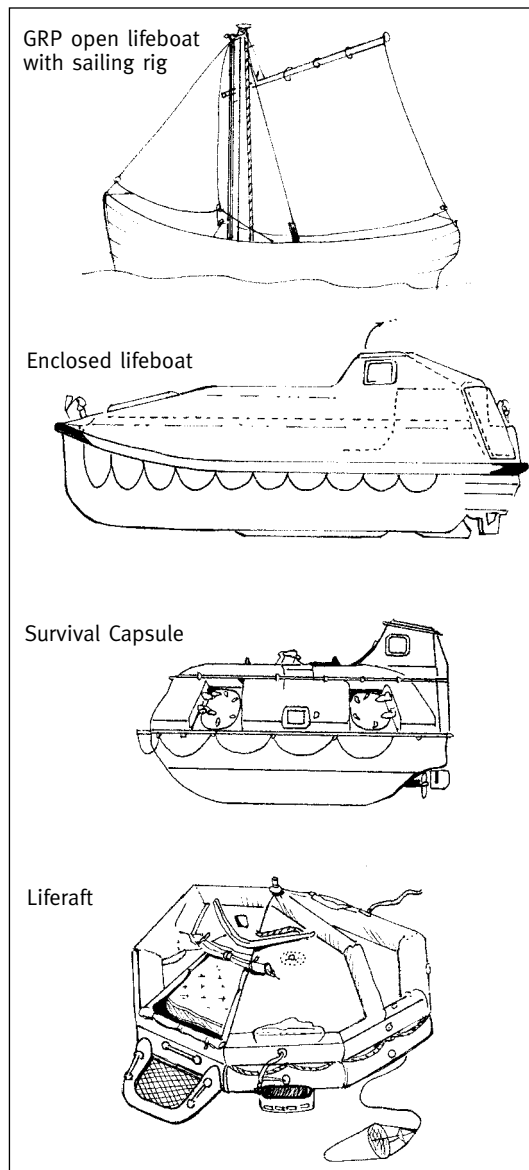

11.13 GROUNDING VESSELS AND DAMAGE CONTROL

Before assisting a boat aground, the coxswain must make a thorough analysis of the situation. The following are some key points to consider:

- Was anyone injured in the grounding? Are all occupants safe and accounted for? Is there any risk of having to enter the water? Advise occupants to don life jackets, and hypothermia protection as the circumstances dictate. Advise them to prepare life raft/lifeboat as the circumstances dictate. Is medical aid required? Above all, remember that your number-one priority is to save lives. In some cases, that may be all that you do in your tasking;
- Is the vessel damaged or taking on water or leaking contaminants into the sea?

Note: No immediate attempt should be made to pull off a vessel that has been or is suspected to have been seriously damaged. If there is any doubt as to the vessel's ability to remain afloat, no attempt to refloat the vessel should be made by the SAR unit.

- Is it necessary to refloat the vessel, or can anchors be set to await the tide?
- What are sea conditions, tidal conditions, and weather (both present and forecasted)?
- If the vessel is to be refloated, are its towing attachment points of adequate strength?
- Is the SRU capable of pulling the vessel off?
- Are your pumps ready and adequate to handle the situation should damage occur in towing the vessel off?
- Does the operator agree to the towing waiver?

Immediately after arriving on scene and conducting an initial assessment, the coxswain should inform RCC/MRSC of the situation and request any additional aid required (MEDEVAC, pollution equipment, etc.).

If the vessel is damaged, anchors should be set to prevent further damage, and no immediate attempt should be made to pull the vessel off.

Even if there is no damage at the time of your arrival on scene, there is the ever-present danger of the situation deteriorating in a short time. Two severe dangers are broaching and pounding.

11.13.1 Broaching

Broaching is the result of surf striking a vessel on the side or quarter and throwing the vessel broadside. It is particularly dangerous for two reasons:

- Broaching tends to drive the vessel harder aground;
- Currents are established about the bow and stern. Sand will be scoured away from the bow and stern and deposited amidship on the leeward side of the vessel, consequently leaving the vessel supported only amidships. This situation often results in breaking the keel of the vessel, rendering the vessel a total loss. Refloating should not be attempted in these cases.

11.13.2 Pounding

Pounding is caused by the varying degrees of buoyancy in a grounded vessel. The waterline changes continuously as waves influence the forces of buoyancy in the beached vessel. Simply stated, an alternate increase and decrease in the vessel's total buoyancy occurs. Bottom damage occurs when the buoyancy increases sufficiently to lift the vessel off the bottom and then decreases and drops it back again. Damage may range from tearing a few seams open to serious holing of the vessel. The striking of each wave tends to drive the vessel further aground.

11.13.3 Refloating procedures

Guideline procedures for assisting a grounded vessel are as follows:

- Ascertain set, and plan to use it to your advantage;
- Ensure that anchors have been laid out to seaward to prevent the vessel from being driven further aground;
- If hull damage exists, determine the location and extent. If the boat is beached, have a beach party from your unit visually inspect and evaluate the condition of the vessel (if possible). Ensure the vessel's interior hull is free of sand, water and leaks. Be sure that it is not leaking pollutants into the sea. If the vessel is holed, temporary repairs will be required to reduce leakage to a minimum. If the vessel has a wooden hull, ascertain whether any seams have worked open. Effect temporary repairs if possible.

Note: Consideration must be given to the fact that a damaged vessel that is refloated by an SAR unit will have to be towed or escorted to safety. The SAR unit cannot be laboured with the responsibility of assisting the vessel for long periods of time, effectively keeping the SAR unit from responding to other SAR incidents.

CAUTION

If there is ANY doubt as to the vessel's ability to remain afloat, NO attempt to refloat the vessel should be made by the SAR unit.

If the assessment reveals that the vessel will remain afloat, and if the SAR unit intends to attempt refloating, further action must be planned carefully to avoid unnecessary and excessive stress on the grounded vessel's hull and/or towing equipment. The following are factors to be considered:

- Does the towing vessel have adequate power?
- Does the towing equipment have a sufficient SWL to carry the static load?
- Are the attachment points and hull structures of both vessels adequate? Employ the strongest fittings on both vessels;
- What are the sea conditions?
- What are the tidal conditions? What was the state of tide on grounding? Unless weight is removed from the grounded vessel, refloating should not be considered at a lower tidal height than that at which it went aground;
- What is the present and forecasted weather?
- Has the vessel's stability changed since the grounding? (e.g., have tanks been pumped out, fish holds emptied, ice dumped? Removal of "low" weight in an attempt to lighten the vessel may mean that it will no longer be stable when partially afloat or afloat);
- Is shoring required to support the vessel while awaiting the tide?

CAUTION

Any attempt to refloat a vessel before the tide rises to the level of the vessel's draft will result in excessive strain to towing hardware and damage to the hull of the stranded vessel.

- Sound around the grounded vessel and the general area of the grounding. The soundings assist in determining the direction in which the boat will be pulled in refloating;
- Carefully determine the refloating procedures to use.

Note: sailing vessels and deep-keeled vessels will require prompt action to either refloat or shore up. On an ebbing tide, they can shift position quickly, causing immediate structural damage and/or allowing the vessel to flood through above-deck openings on the flood tide.

11.13.3.1 Straight pull

When the vessel is slightly aground (bow into the bottom and the stern afloat), a straight pull off is the simplest and most effective method of assistance. The straight pull is conducted as follows:

- Ascertain the direction of current;
- Consider anchoring at a safe distance and backing down on your anchor line to the stranded vessel;
- If you can safely get close enough, hand the towline directly aboard. If you must use a messenger line, the hand-thrown heaving line is preferred. Another method to transfer this line is by using a buoyed, floating line. This must be done cautiously in order to avoid fouling your propellers with the line and putting your own vessel aground. The line should not be floated straight down to the vessel. Pay it out parallel to the shore. Position your vessel upstream from the grounded vessel, and pay out the messenger until the end is near the shore. Turn about and manoeuvre past the stranded vessel, paying out the messenger as you go;
- Instruct the disabled vessel on securing the towline, clearing personnel from the deck area and letting the anchor go after it clears the beach or shoal;
- After the towline is secured and the crew clear of the danger area on deck, go ahead slowly, weighing anchor and paying out the towline to maintain a generous catenary. This requires pre-planning and flawless crew communication and coordination;
- Commence pulling so that optimum force can be applied at maximum high water. The stranded vessel can best be pulled off in the direction opposite to that in which it ran aground.

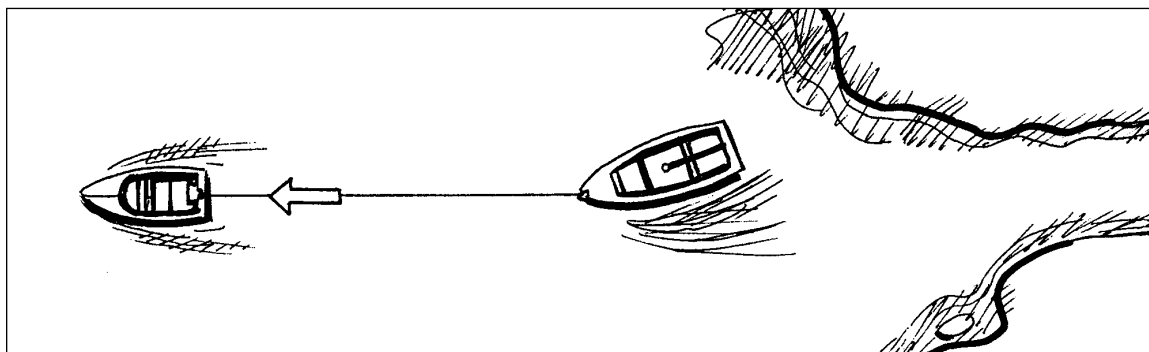

Figure 11.24: Straight pull

11.13.3.2 Wrenching and pulling

Although the name sounds violent, this method is much the same as the straight-pull method. The difference is that the vessel is pulled alternately from side to side. This method is utilized when the grounded vessel is on bottom that cannot be scoured or the water is too shallow to allow work alongside the grounded vessel. The goal of this method is to break the grip of the hull on the bottom by pulling from side to side (wrenching) and rotating the hull.

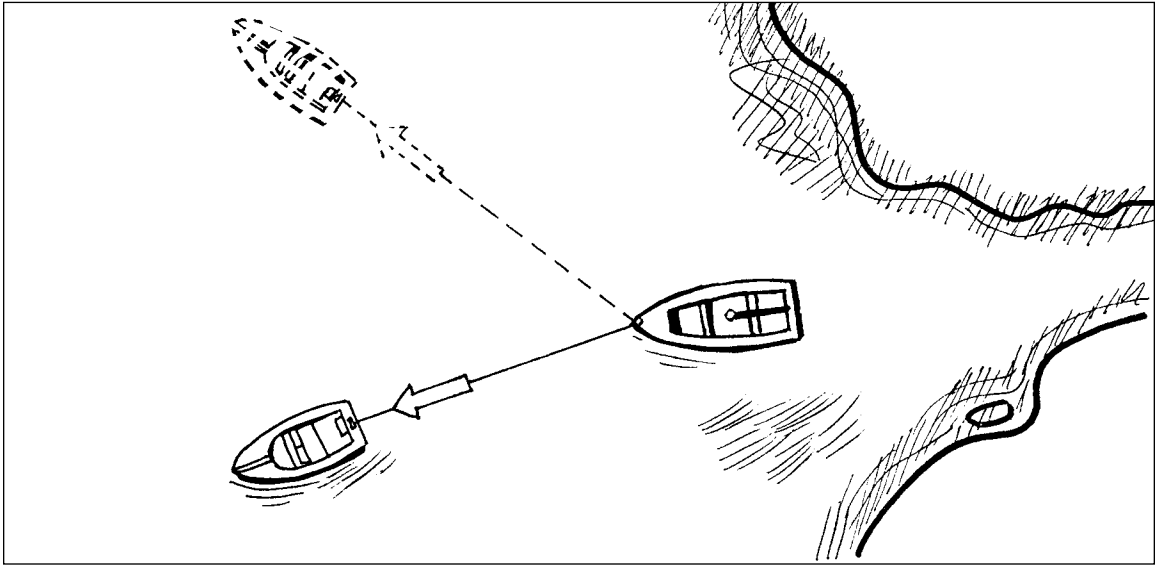

Figure 11.25: Wrenching and pulling

11.13.3.3 Bow-on pull

The bow-on pull is employed when the wind and current are offshore or from inland and no surf conditions are present. This method is as follows:

- Fully brief the disabled vessel on the procedures. Approach the casualty bow from windward or up current, drifting toward the stern of the vessel;
- Pass the messenger and towline from your bow;
- Secure the towline to a suitable connection point aft of your bow. You will lose pivoting ability if the towline is secured directly at the bow;
- Apply power gradually and back down slowly.

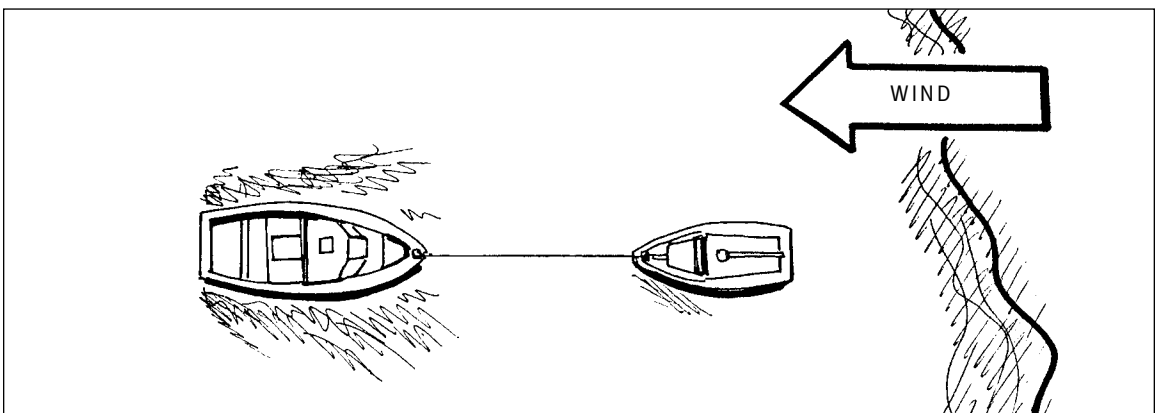

Figure 11.26: Bow-on pull

11.13.3.4 Scouring

Note: The scouring method is not recommended for use on vessels that have grounded in a broaching situation. Such vessels may be in a very unstable and precarious position because of the sand accumulated in the midships region. Use of the scouring method in a broach situation may cause severe damage to the vessel and/or injury to personnel.

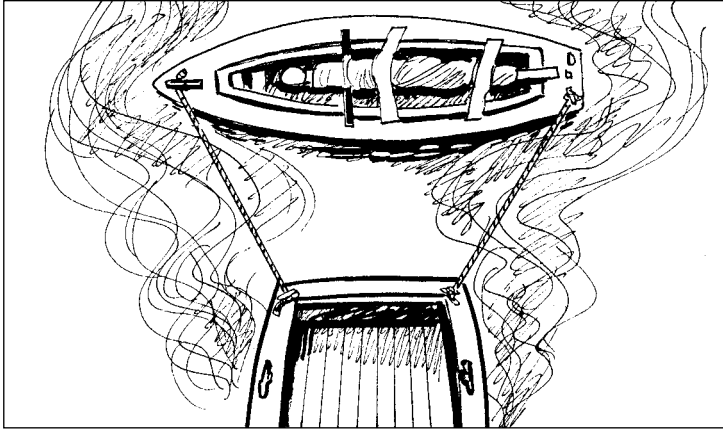

Figure 11.27: Scouring

Scouring is a very effective aid in refloating a stranded vessel. However, the damaging effects of the bottom material on your shaft bearings and raw-water cooling systems must be considered. Scouring a channel for the distressed vessel can be done only when the endangered vessel is grounded in sand, mud, or gravel bottom, and only when water depth permits you to work alongside the other vessel. Scouring a channel is accomplished by:

- Moor alongside the stranded vessel amidship so that your boat's screw current will be directed diagonally down and under the grounded vessel;
- Initiate scouring amidships and, as the application advances, move your vessel aft or forward as required.

11.13.3.5 Heeling sailing vessels

Sailing vessels with deep keels, aground on an ebb tide, will have to be either shored up or removed from the grounded position as quickly as possible. If action is not taken, the hull may sustain severe damage from pounding. Heeling the sailing vessel over to one side creates a corresponding change in angle of the deep keel and reduces the effective draft. To free a grounded sailing vessel, proceed as follows:

- Lead a spinnaker halyard from the mast to another vessel or a fixed object. Pull on the line either by hand or by gently towing;
- Often the vessel will drift off on its own when heeled by the mast. If it does not, either have the operator apply power or gently tow it off;
- When the vessel is free of the shallow area, immediately release the line used to heel it over.

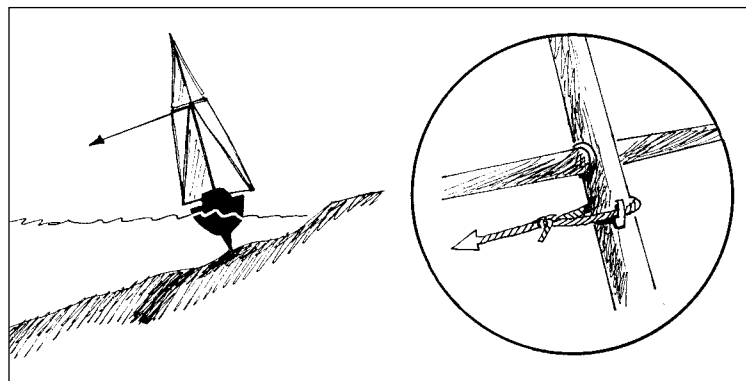

**Figure 11.28:
Heeling sailing vessels**

11.13.4 Damage control in SAR incidents

WARNING

If there is any doubt as to the vessel's ability to remain afloat, or if there is potential danger to the crew, no action should be undertaken to dewater the disabled vessel. Information gathering from a disabled vessel is important to ensure adequate situation analysis. Always bear in mind that the primary role of your SAR unit is saving life, not salvaging.

Performing damage control in SAR incidents is a very hazardous task. Often it is very difficult to assess the extent of damage and to determine what, if any, actions are appropriate. In addition, there may be panic on the disabled vessel, especially if the water level is rising. In most cases, passing the pump is the only required action. Sometimes, however, greater help is needed, and this section offers suggestions.

With small holes, dewatering can be attempted right away, but with larger holes the water flow must be reduced. Various methods exist to perform this task, requiring a variety of material. If a ready locker is being used by an SRU due to the lack of space on board, it would be wise to have a Damage Control Kit in the locker at the station.

11.13.4.1 Water flow control methods

There is no standard method of controlling the flow of water. It is the coxswain's responsibility to determine which of the following methods will be used.

Wood plugs and wedges

Use them from inside when the hole is accessible; it could be very hazardous to try to plug a hole from outside the hull. Wrapping a piece of cloth around wood plugs or wedges will increase their efficiency.

Hinged patch

Patching below the waterline can be done with a hinged patch. To use it, fold the patch and push it through the hole. Then, pull it back tightly against the hole with the line and secure it to a fixed point. If the water pressure is too high or the hole is not accessible, the line can be floated through the opening from outside. It has to be guided to the opening, and with the water flow it will be sucked through. The line should be of polypropylene, which will allow the line to float inside and then be pulled as stated above.

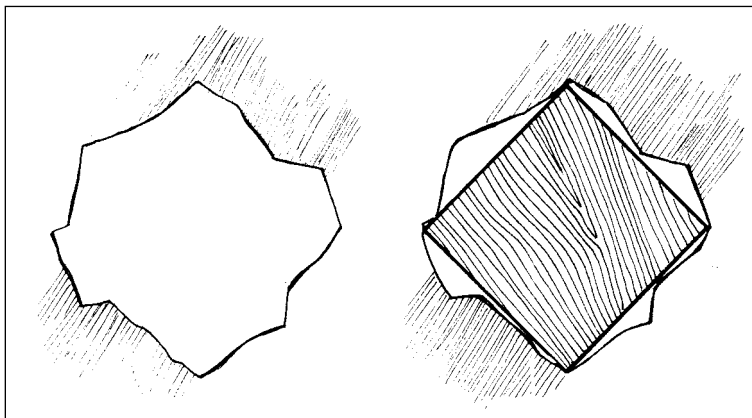

Figure 11.29: Wood plug

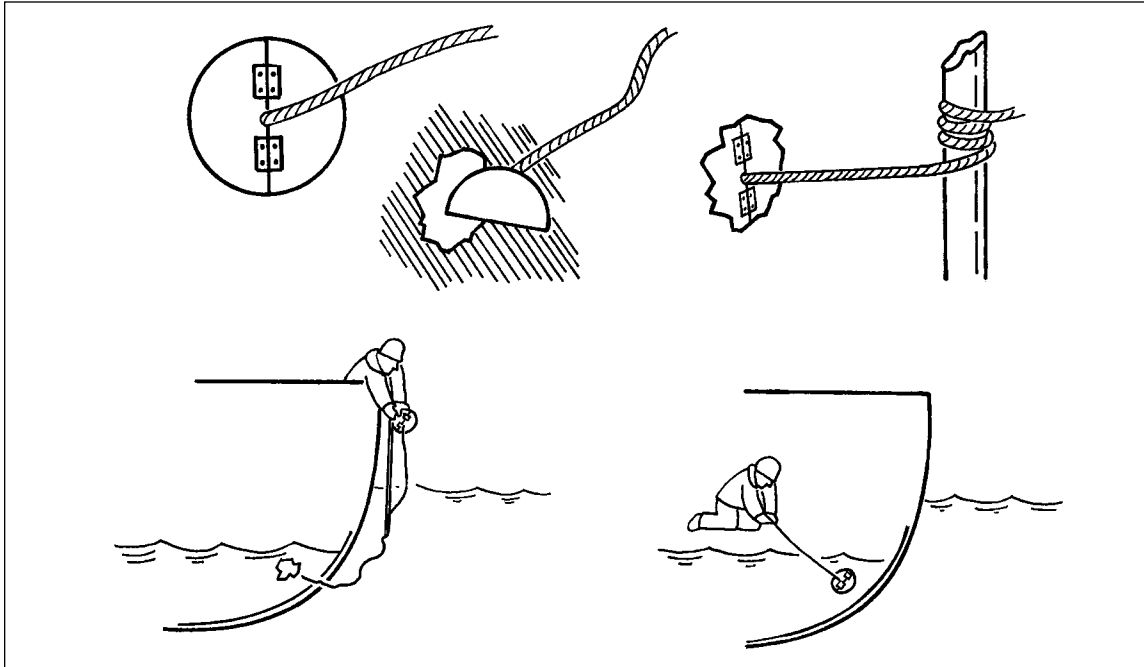
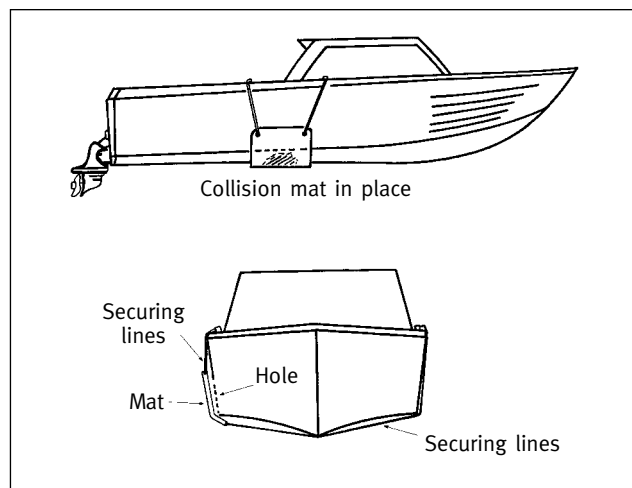

Figure 11.30: Hinged patches

Collision mats

These can be a very effective way to control flooding, particularly if the damage is on the bow and the vessel is underway. The water pressure will keep the mat in place. It will also be possible to place additional patching on the inside.

Figure 11.31: Collision mat



Tarpaulin

When collision mats are not available, simple tarpaulins can be used. These are easily available from most hardware stores and can be quite helpful for damage control purposes.

Shoring

As every hull has a different shape, it is difficult to provide guidelines for installing shoring. Using what is available in accordance with the damaged environment is the best rule to apply.

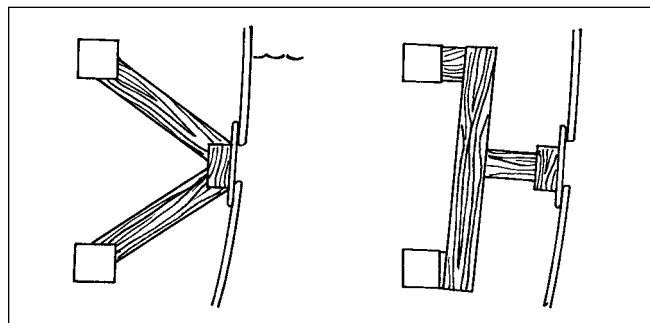

Figure 11.32: Shoring

Other options

The use of the disabled vessel's pump is obviously an option to take into account. On some vessels, it may be possible to use the seawater cooling pump by diverting its suction to the bilge. Use of eductors is also possible with the SAR unit's fire pump.

11.13.5 Suggested damage control kit

Small SRUs such as RHIB have limited space. A tarpaulin is probably the best option. It may not be necessary for those vessels to carry a full complement of plugs, hinged patches, etc. since these are not designed to operate very far from the shore. Larger vessels such as fishing vessels (CCGA) might consider having a more complete kit that would include some of the following:

- soft wooden wedges (six 2" x 2" x 8"; six 4" x 4" x 12"; eight 2" x 4" x 12");
- plywood patch (twelve 8" x 8" x 1/4");
- soft wooden plugs (three 3" x 4"; three 2" x 4"; three 1" x 4");
- hammers (one 16-oz. and one 24-oz. ball pin head);
- four 4-ft. long 2 x 4s;
- set of saws;
- lineman's pliers, 8";
- 36" canvas, oakum, rags, rubber sheets, etc.;
- one tube of RTV (silicone rubber);
- waterproof flashlight with spare batteries ;
- one bit and brace and 7/16 wood auger;
- hinged patches (one 12" and one 18");
- one box of nails, no. 10, 2";
- putty knife;
- roofing caulking;
- tie wire and tarred marlin;
- one roll of tape, scotch brand no. 33;
- one 16-ft. measuring tape;
- plywood (two 2' x 4' x 1/2");
- quick-set cement.

11.14 RESCUE OF CAPSIZED VESSELS

When assisting capsized vessels, SAR crews should always remember that their priority is life. SAR crews should never waste too much time preventing damage to a capsized vessel when there is a potentially life-threatening situation developing.

Any attempt you make to right a capsized vessel must be carefully thought through before beginning. You must make absolutely certain that all crewmembers from a distressed vessel are accounted for before beginning any procedure to right the vessel. Survivors may be trapped inside the overturned hull.

When an inboard boat capsizes, dewatering cannot begin until the craft has been righted. There are several methods for righting vessels of this type. You will have to select the best one after evaluating the conditions on scene. Regardless of the method used, always get an accurate count of the persons aboard the capsized boat. Give them PFDs if necessary, and bring them aboard your boat before beginning the righting operation. Approach a disabled craft cautiously, watching for debris that may damage your boat or foul its propellers.

When assisting a capsized vessel:

- recover all PIW immediately;
- check all recovered PIW for injury and/or hypothermia;
- if anyone is injured or hypothermic, organize transport toward shore and have another unit (if possible) take care of the boat. If no one can deal with the boat right now, leave it there and notify MCTS;
- if RCC allows and no other urgent situation is present, have the waiver of claims signed and prepare the righting procedure;
- choose an appropriate righting technique;
- discuss the procedure with the boat operator(s);
- assign tasks to everyone and proceed.

Most righting techniques require the presence of a crewmember in the water as a last resort. When sending a crewmember into the water is necessary, follow these guidelines:

- Pick a strong swimmer;
- Have your swimmer properly equipped (thermal protection, fins, mask, PFD, strobe light, etc.);
- Tie the swimmer to a line so he or she could be easily recovered if anything went wrong. The swimmer should carry a knife in case the line must be cut;
- Ensure that the swimmer knows exactly what to do.

11.14.1 Righting powerboats

The means you select for attaching lines determines the method of righting. Procedures for each method are outlined below.

11.14.1.1 Righting a powerboat by parbuckling

Follow these procedures when righting powerboats by parbuckling:

- Select a crewmember to enter the water to prepare the boat for righting;
- Direct a crewmember to secure your towing bridle or mooring lines to the nearest gunwale of the capsized boat;
- A person in the water then leads bridle lines or mooring lines over the keel and down under the boat. Ensure that these lines are outboard of all handrails, lifelines, and stanchions. Then run the bridle back to your tow line, or run the mooring lines to your boat's rear quarter cleats or bitts;
- Recover the tethered swimmer from the water;
- Pay out enough towline to prevent the boat from hitting your stern during righting and towing. Then, secure the towline;
- Gradually add power to your boat and increase speed. The boat should right itself;
- Bring the righted boat alongside your boat and dewater with the most appropriate method;
- Take in tow astern or alongside.

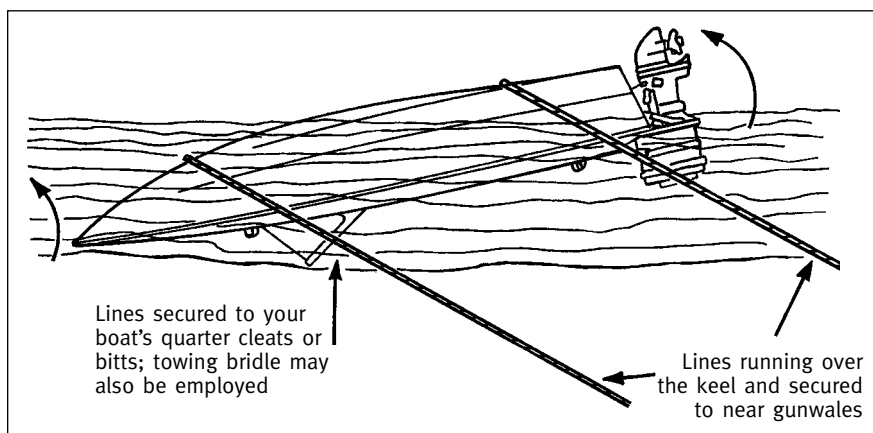

Figure 11.33:
Re-righting
powerboats
by parbuckling

11.14.1.2 Righting using bow and transom eyebolt

Follow procedures below for righting a vessel using the bow and transom eyebolt:

- Bring the capsized boat alongside the working area of your boat;
- Use a shackle to secure your tow line to the trailer eyebolt of the capsized boat;
- Secure a piece of mooring line to the capsized boat's outboard transom eyebolt;
- Pay out both a towline and a scrap/mooring line and walk the capsized boat to a position astern of and athwartships to (from side to side) your boat;
- Secure the scrap/mooring line to your boat's rear quarter cleat or bitt;
- Pay out enough towline to enable the boat to remain clear of your stern when righting and towing commences. Secure the towline;
- Gradually add power to your boat and increase speed. When the righting motion begins, cut or slip the scrap/mooring line. The boat should right itself. Tow the righted boat until you observe water being forced over the transom of the disabled boat;

When water ceases to flow over the towed boat's transom, reduce speed gradually, ensuring that enough water has been forced out of the boat during towing to allow it to float on its own;

- Bring the righted boat alongside your boat and dewater it using the most appropriate method;
- Take in tow astern or alongside.

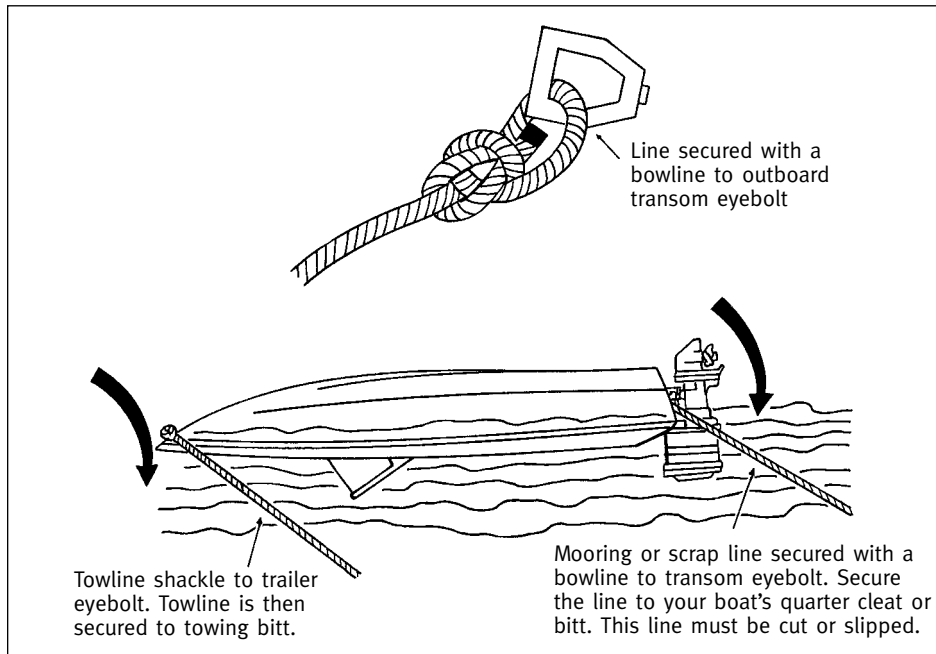

Figure 11.34: Righting capsized boats using bow and transom eyebolts

11.14.1.3 Righting using towline fore and aft of boat's keel

Follow the procedures below for righting a boat using a towline fore and aft of the boat's keel:

- If the operator is willing, one person wearing a PFD may be left in the water to assist in righting the boat;
- If no one aboard the boat is able to assist, direct a crew member (as a last resort) to enter the water to prepare the boat for righting;
- Direct the person in the water or a crewmember to run your towline fore and aft alongside the capsized boat's keel;
- The person in the water will then secure your towline with a shackle to the capsized boat's trailer eyebolt;
- Ensure the disabled boat is positioned fore and aft, directly astern of your boat (capsized boat's stern toward your boat's stern), and that the towline is running fore and aft along the capsized vessel's keel;
- Pay out enough slack in the towline to enable the boat to clear your stern when righting commences. Secure the towline;
- Gradually add power to your boat and increase speed. pulling on the bow of the capsized boat. This pull will be countered by the aft portion of the disabled boat, which is the heaviest part of the craft. As a result of these two forces, the boat will be righted;

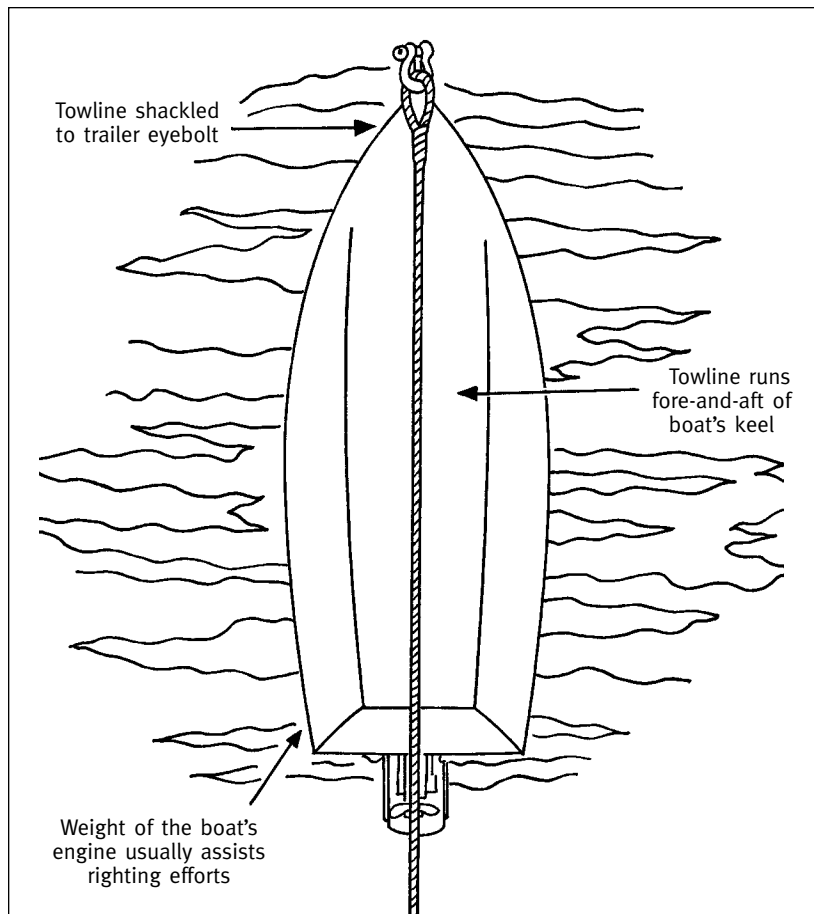
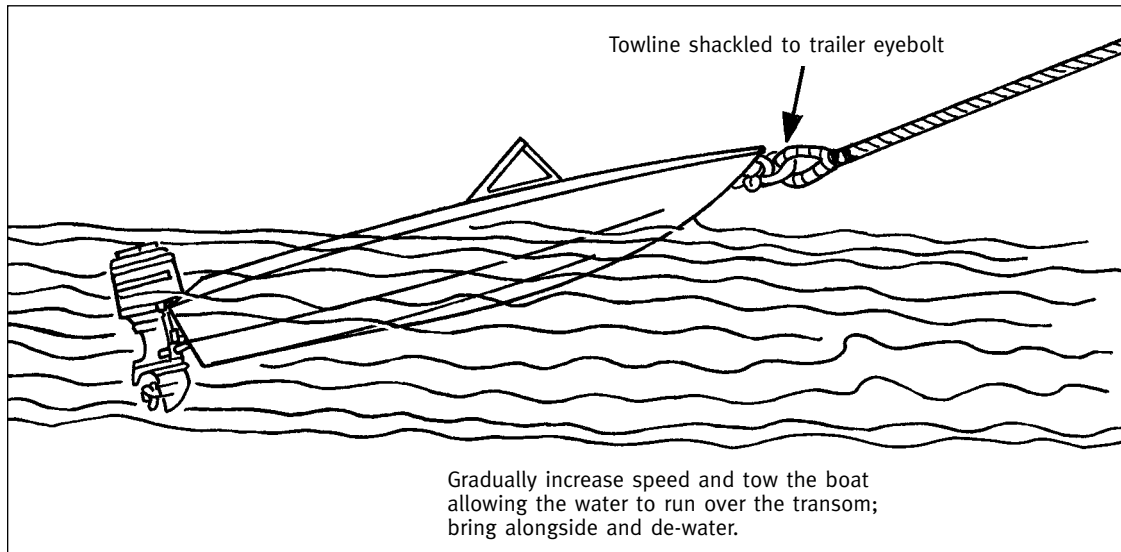

Figure 11.35: Righting using towline fore and aft of boat's keel

- Tow the righted boat until you observe water being forced over the transom of the disabled boat;
- When water ceases to flow over the towed boat's transom, reduce speed gradually, ensuring that enough water has been forced out of the boat during the towing to allow it to float on its own;
- Bring the righted boat alongside your boat and dewater it using the most appropriate method;
- Take in tow astern or alongside.

11.14.1.4 Refloating swamped boats astern using trailer eyebolt**Figure 11.36: Refloating boats swamped astern using trailer eyebolt**

This procedure is used for refloating a boat that has been swamped from astern:

- Bring the swamped boat alongside the working area of your boat;
- Use a shackle to secure your towline to the trailer eyebolt of the swamped boat;
- Pay out your towline and walk the swamped boat directly astern of your boat;
- Pay out enough towline to permit the swamped boat to remain clear of your stern when towing commences. Secure the towline;
- Gradually add power to your boat and increase speed taking the swamped boat in tow. Tow the boat until you observe water being forced over the transom of the disabled boat;
- When water ceases to flow over the towed boat's transom, reduce speed gradually, ensuring that enough water has been forced out of the boat during towing to allow it to float on its own;
- Bring the boat alongside your boat and dewater it using the most appropriate method;
- Take in tow astern or alongside.

11.14.2 Righting small sailboats

Always try to unship the sails (or at least to loose the halyards) before attempting the righting procedure. If you do not lower the sails, the boat may capsize again once righted. Approach the capsized sailboat from upwind, up current, or both, remaining clear of lines and debris. Account for all personnel from the sailboat and recover them as necessary. At least one person from the capsized boat will be needed in the water, to help in righting the boat. Do not attempt righting if the weather presents a hazard to the rescue boat or personnel.

Procedure:

- The person in the water unships or removes the sails;
- The sails, if removed, should be put aboard the rescue boat or secured to the disabled boat;
- Whenever possible, try to position the capsized vessel so it faces the wind;
- The person in the water then stands on the keel or centreboard and leans back while holding on the gunwale. The boat should slowly begin to come back over;
- Once the sailboat is righted, recover the swimmer and begin dewatering.

This technique will almost always work when the wind is not too strong and the mast is not buried in the bottom. With a boat hook, lift the mast above the water and swing it upward as the operators are doing their usual righting technique. Be careful not to be struck by the falling mast if the righting attempt failed. Ideally, your vessel should never get directly below the mast of the capsized vessel.

11.14.3 Righting larger vessels

Large overturned vessels present the possibility that occupants may be trapped inside. The following are general guidelines for rescue of persons trapped inside a capsized vessel:

- Search the immediate area for survivors that may have escaped from the vessel;
- Approach the vessel slowly to eliminate wash that may break a sealed air pocket. Try to determine whether any persons are trapped in the vessel and, if so, their location;
- Question other survivors to assist in determining possible locations of survivors and the vessel layout;
- Do not put rescue personnel directly on the overturned vessel. Work from the rescue craft or tender. Communicate through the hull by tapping on it and calling to the occupants. If contact is made, reassure the survivors that rescue efforts are underway. Instruct them to stay calm, to move out of the water as far as possible, and to minimize their physical activity to aid in conserving air. Throughout the operation, keep them informed on steps that are being taken in their rescue. Any changes, movement, or noise will be very frightening to them. If they don't know the source, they may panic and try to climb out;
- Request passing or approaching vessels to reduce their speed and wash;
- If necessary, hold the vessel off a lee shore (especially if potential survivors are still inside);
- Rescue may be achieved by trained divers. Request divers with rescue training (such as DND or RCMP divers) through RCC/MRSC;
- If possible, locate someone familiar with the vessel layout;
- Stabilize the hull by using emergency air bags, boats secured alongside, or heavy shipboard lifting tackle. If using vessels secured on either side, pass a line under the capsized vessel and secure between the two vessels. **DO NOT ATTEMPT TO RIGHT THE VESSEL AT THIS STAGE;**
- Tag the vessel with a line and marker to mark the position in case it sinks;
- If a person familiar with the vessel layout is contacted, consider having that person coach the survivors on how to escape or divers on how to locate the trapped persons;
- If divers arrive, fully brief them on all known details and assist them as required;
- If you must tow the vessel, tow extremely slowly to avoid breaking the air seal.

WARNING

Never attempt to cut through the vessel's hull while it is still afloat unless some procedures to keep afloat have been undertaken.

11.14.3.1 Righting technique

If you are absolutely certain that all survivors have been evacuated from the overturned vessel, you may attempt a righting procedure. Parbuckling may be used to right capsized powerboats or sailboats over 8 m (25 ft.) in length. Also, parbuckling should be used for righting small sailboats that cannot be righted by the method previously described.

As a last resort, a person from the overturned boat or a crewmember from the rescue boat must enter the water to prepare the boat for righting. The following procedures are for righting a sailboat using parbuckling.

CAUTION

If the weather presents a danger to the person in the water or the boats involved, do not attempt righting.

The following are procedures for righting a small sailboat:

- Unship or remove the sails;
- Have the person in the water run a bridle or towline to the capsized boat;
- Ensure that the lines rigged for righting are outboard of all stays, shrouds, lifelines and stanchions;
- Secure lines to available deck fittings;
- Connect the other end of the bridle to the towline. Pay out enough line to prevent the distressed boat's mast (if so equipped) from striking the rescue boat should the distressed boat continue to roll in that direction;
- Recover the person in the water;
- Commence righting by going ahead slowly on the engines;
- Once a sailboat is righted, crewmembers should board it from the stern (because of the boat's instability) and secure all loose lines;
- Secure the boom to stop it from swinging and possibly capsizing the boat again;
- Begin dewatering.

11.14.4 Kayaks, canoes and small rowboats

Kayaks and canoes are so small that the best way to reright them is to bring them on board. Once they are on board, empty them and put them back in the water.

11.14.5 Rescue of a vessel drifting onto a lee shore

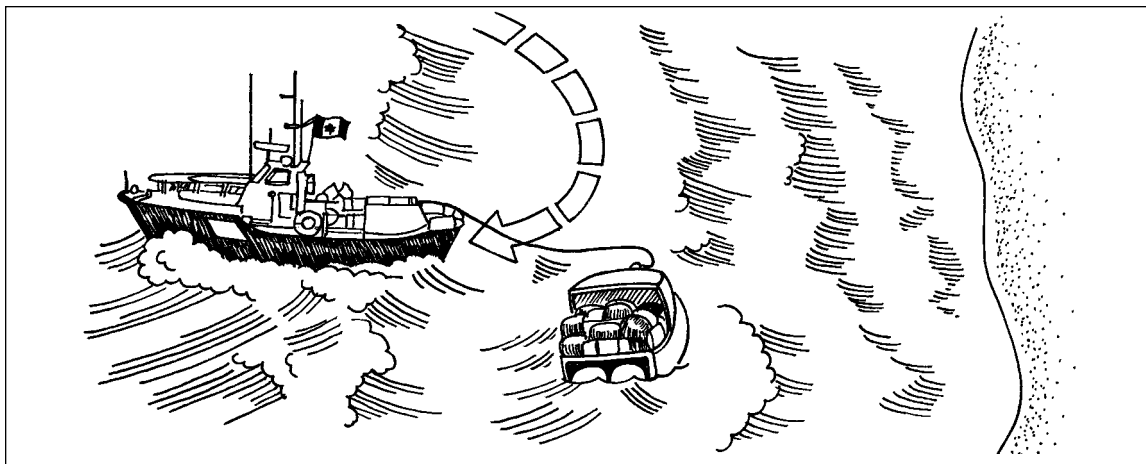

Figure 11.37: A vessel drifting onto a lee shore

A vessel drifting onto a lee shore in rough seas can incur serious consequences if rescue is not effected in a timely manner. If you encounter such circumstances, follow these general guidelines:

- En route, advise the vessel operator to have everyone aboard don life jackets and to drop anchor. (There have been cases involving vessels drifting ashore in which a ready and available anchor was not used. People may forget that they have an anchor for use in just such an emergency.);
- If anchoring is not possible or will not hold, it is important to get the towline passed as quickly as possible. Have all required towing equipment ready for arrival on scene, bearing in mind that the seas on scene may be agitated (e.g., secure towline to prevent the possibility of fouling screws). Approach the disabled vessel in an arc from seaward, keeping the SRU to windward of the disabled vessel. The path of the arc should bring the stern of the SRU across the beam of the disabled vessel. At this point the line should be passed, but at no time should the SRU lose headway or be allowed to drift toward the shore. When the line is secured, the SRU should start towing immediately to slowly pull the distressed vessel out of danger;
- Once the disabled vessel is clear of the lee shore danger, the towline should be checked and adjusted as necessary to carry on with the tow;
- If water depth or sea conditions are such as to endanger the SRU, the towline should be passed by floating down to the casualty or firing a line from a line-throwing apparatus.

11.14.6 Grounded vessels on lee shore or in other danger

Grounded vessels on a lee shore or in other dangerous circumstances require immediate assistance to ensure the safety or rescue of the crew. The following general guidelines should be considered in assisting a grounded vessel in a dangerous position:

- En route, establish communication, advise the crew to don life jackets and prepare emergency equipment. Try to determine the degree of danger and urgency of abandoning;

- On arrival on scene, further assess the situation and determine:
 - the danger and need to remove the crew;
 - your ability to remove the crew;
 - need for helicopter assistance to remove the crew;
 - any danger to your vessel; and
 - whether you can assist the vessel off.
- If the situation will allow the SRU to assist the vessel off, take precautions to ensure that the vessel will not take on water and sink when it is refloated. Take precautions to ensure the crew's safety (e.g., remove crew, provide a tender, pass pumps, etc.);
- If the vessel will not be refloated and the crew will be taken off, consider your vessel's ability to approach the disabled vessel and remove the personnel. Is the depth of water adequate? Are there underwater obstructions, debris in the water, or appendages on the vessel below or above the waterline? Is there a lee or a safe position to approach with the least aerated water? Could wave oil be used to reduce the risk?
- If the decision is made to approach the vessel and remove the crew directly, discuss your plan with the master. Maintain communication. Have the crew ready to abandon on your approach. You may want to divide a large crew into more than one transfer.

CAUTION

Never take your vessel into the surf line!

If the vessel cannot be approached to conduct a direct removal of personnel, consider using a tender to conduct the transfer, either by manning the craft or floating it down on a line. A life raft may also be floated down to the vessel.

11.14.7 Boosting another vessel

WARNING

Boosting is a dangerous procedure, and proper guidelines should be closely followed. To increase safety and minimize the risk of explosion, consider installing boosting outlets away from your battery compartments. Another option is to boost from a boosting battery (spare battery). Never let the operator of the disabled vessel plug the cables. Always send one crewmember to handle the boosting cables.

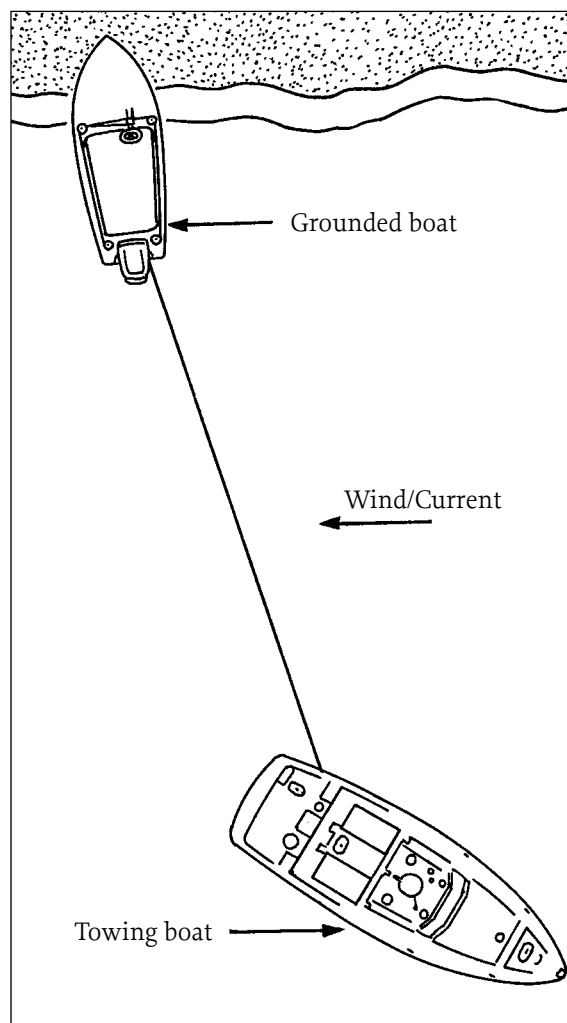

Figure 11.38: Grounded boat

11.14.7.1 Procedure for boosting

- Wear protective clothing (gloves and safety glasses). If an explosion occurs, this clothing will provide some protection against battery acid and projected debris;
- Ventilate the battery compartments before clipping the cables. This is of paramount importance to minimize the risk of explosion;
- Turn off the ignition and all battery-powered accessories on both vessels. It is not necessary to have the engine running while boosting;
- Use appropriately-sized boosting cables. Ensure that the cables are in good condition. Remember that the red jumper clip goes on the positive (POS or +) battery terminal and the black jumper clip, on the negative (NEG or –) terminal. If the battery terminals cannot be identified clearly, do not attempt to boost;
- Clip the cables in the following order:
 - Red jumper clip to the positive terminal on the dead battery;
 - Other red clip to the positive terminal on the good battery or boosting outlet;
 - Black clip to the negative terminal on the dead battery;
 - Other black clip on the negative terminal on the good battery or boosting outlet.
- Now that the two batteries are connected, try to start the disabled engine. Do not run the starter for more than 15 seconds. If the engine does not start after 5 minutes, disconnect the battery and abort the procedure. If you persist, you are likely to deplete your battery as well. At this point, consider towing;
- Once the engine is started, remove the cable clips in the reverse order:
 - Black clip of the negative terminal on the good battery or boosting outlet;
 - Other black clip of the negative terminal on the previously dead battery;
 - Red clip of the positive terminal on the good battery or boosting outlet;
 - Other red clip of the positive terminal on the previously dead battery.
- Advise the master of the previously disabled vessel to leave the engine running for at least 30 minutes to recharge the battery. Another option is to charge the battery to full capacity with a battery charger. When using a battery charger, always clip the battery before plugging the charger.

If an explosion occurs and acid is spilled on a person, treat that person for chemical burns and trauma. Rinse the exposed areas with water for 15 to 20 minutes and send the person to a hospital. If acid is spilled in the eyes, remove contact lenses (if applicable) and rinse as usual.

11.14.8 Escorting a vessel

Vessels engaged in SAR may need to escort other vessels for various situations. The most common situations where escorting may be considered are the following:

- disoriented vessels;
- damaged vessels that may eventually require a tow;
- boats in heavy weather.

Escorting is a good method to provide assistance without affecting the readiness of the SRU. Whenever possible, consider escorting before towing.

11.14.8.1 Escorting procedure

When you need to escort a vessel, follow these guidelines:

- Determine the kind of problem and consult with RCC/MRSC to determine whether escorting is required;
- Your destination should be the closest safe haven;
- Explain the route you intend to follow to the operator of the other vessel;
- Advise the other boat operator to follow you at a safe distance. Be aware that he or she may try to take shortcuts. Escorted vessels taking shortcuts are quite likely to run aground in some areas;
- When escorting, make wide manoeuvres and try to stay well clear of any hazard to navigation;

Sometimes, an SRU may be called to a more urgent situation. When this situation arises:

- Determine whether the vessel can continue on her own. If not, advise RCC/MRSC. Other vessels in the vicinity may sometimes continue the escort if necessary;
- Advise the operator of the other vessel to drop an anchor if anything goes wrong for the remainder of the trip. If you can, you may have the opportunity to come back once the more urgent situation is resolved.

11.15 REMOVING/DELIVERING PERSONS FROM/TO SHORE

Several scenarios of SAR incidents require the removal of persons from shore to complete the mission. Some cases may occur in protected waters (or even better at a dock) or, at the other extreme, in exposed or treacherous locations. In all cases, the strategy is to remove the persons safely and to reduce injury or suffering.

11.15.1 Procedure***Evaluate the situation:***

- Is communication established?
- What are the circumstances requiring removal (immediate danger, hypothermia, injured, etc.)?
- Do you have the means of safely removing the persons (adequate crew size, FRC, tender, etc.)?
- What are the consequences of leaving the people until a helicopter is available, the conditions improve, or another more suitable unit arrives to remove the persons?
- Is the rescue vessel safely manned to complete the task and able to deal with internal emergencies?
- What are the risks in attempting removal (seas, injuries, geographical hazards, etc.)?
- Is there another means of evacuating them?
- How can the SAR unit best perform the task (straight transfer from shore, pick up with tender or FRC, float in a life raft, use rescue swimmer and immersion suits)?

Preparation:

- Establish communication (radio, loud hailer, hand signals, etc.);
- Brief crew of intentions, including cautions and/or contingency plan;
- Brief distressed persons of intentions;
- Prepare equipment.

Procedures:

- Choose a landing area that is free of obstacles (both on shore and in the water) and has the least disturbed (aerated) water. **DO NOT LAND ON SURF BEACHES.** Approach the landing area and stand off to observe the action of the seas in the chosen area. After observing the cycle of motion, time your approach to take maximum advantage of the waves;
- Choose an approach angle that will allow you to view the landing zone and protect your stern from the seas. Time your approach to allow persons to board or disembark during lulls or the smallest seas;
- In incidents where a secure, protected landing can be affected, the vessel may be beached during the transfer;
- All persons must wear PFDs or life jackets during transfer.

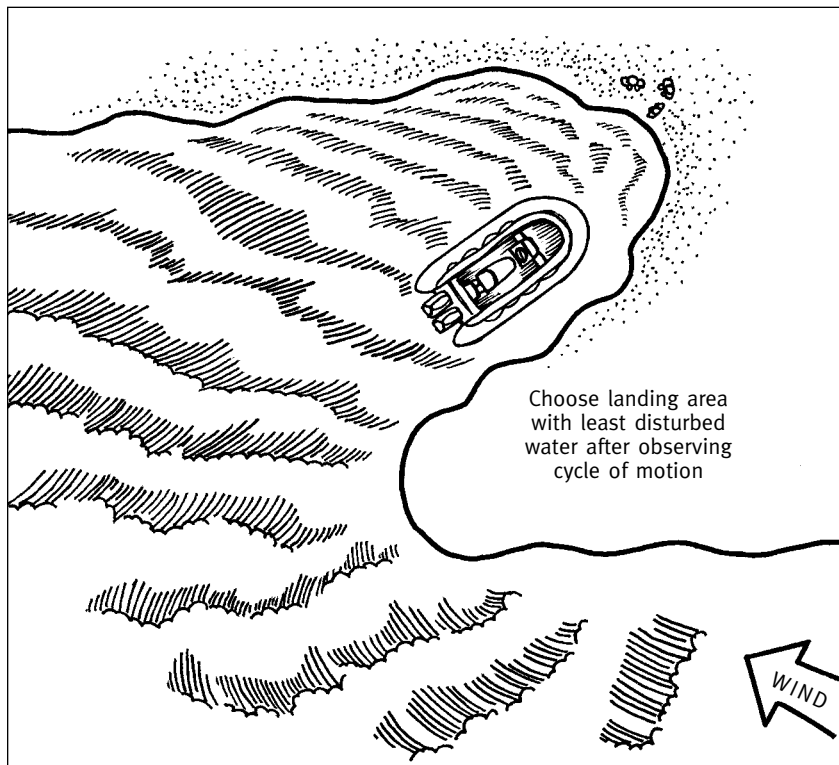

Figure 11.39: Choose an appropriate landing area

11.15.1.1 Life Raft method

Some vessels engaged in SAR may carry a life raft. The life raft can be used to conduct the safe transfer of persons to/from a shore. To use a life raft for such purposes, follow these guidelines:

- Before launching the life raft, the SRU should be positioned to take advantage of wind and current to drift the raft into the beach;
- Consider deflating the canopy of the life raft before sending ashore;
- If the situation will not allow the raft to drift in on its own, a messenger line may be sent ashore by line-throwing gun, heaving line, or floating in with a smaller object;
- The raft will have to be inflated and have adequate line attached to send it in to the beach. Depending on the circumstances, the coxswain may want to send a crewmember in the life raft to assist the survivors. If a crewmember does board the raft, he must be dressed in full protective clothing including hypothermia protection and a helmet;
- Transferring personnel from a life raft to a rescue vessel can be very difficult, particularly in less than calm sea conditions. The life raft will experience constantly varying motion from the soft bottom and soft floor as well as a constantly changing movement of the whole raft, making safe movement of personnel difficult. Good physical handholds must be executed on each survivor by the rescue crew before the transfer takes place from raft to rescue vessel.

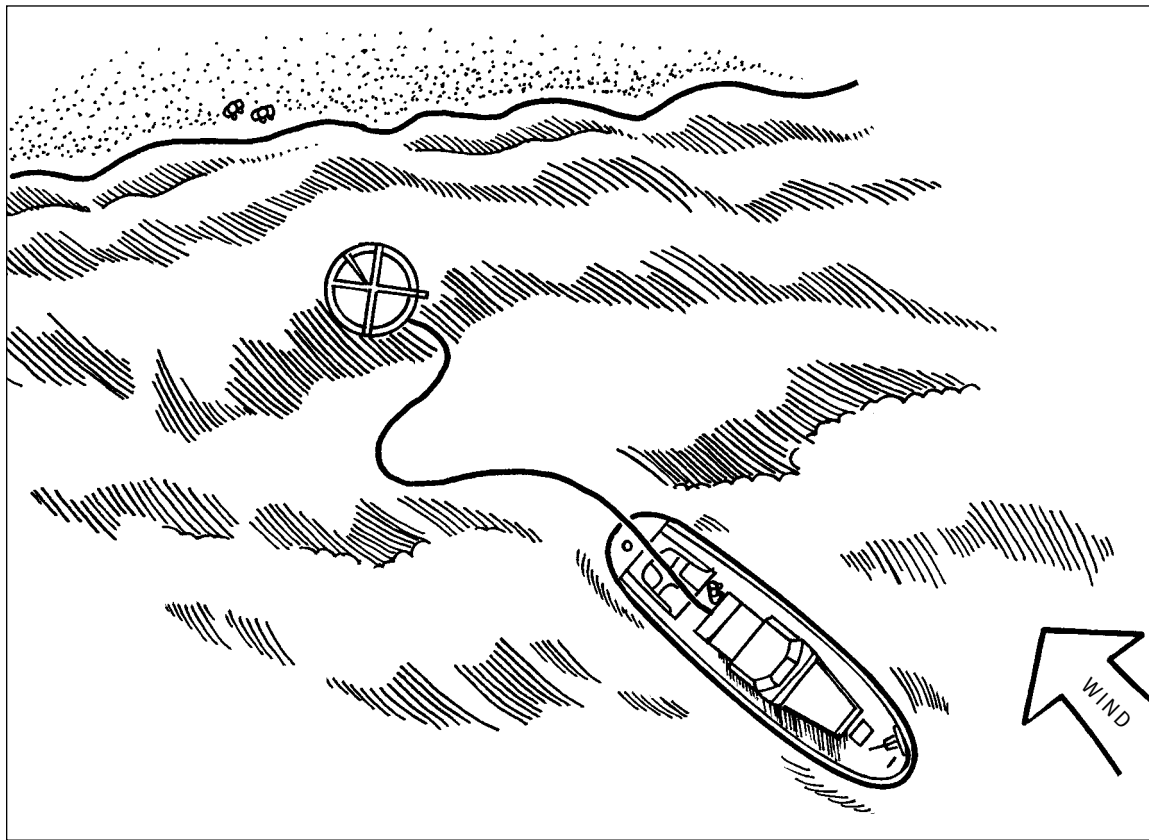

Figure 11.40: Using a life raft to conduct a transfer from/to shore

11.16 REMOVING/DELIVERING PERSONS FROM/TO OTHER VESSELS

Transferring personnel from one vessel to another at sea can be dangerous at all times, but is particularly difficult in cases of medical injuries or people who are not accustomed to being at sea. To further complicate matters, sea conditions may be miserable. In all cases, consideration must be given to the safety and consequences of proceeding with the transfer or not. The degree of danger anticipated by leaving the person aboard the vessel must be weighed against the dangers of transfer. This decision to proceed or abort the transfer is generally made on scene and involves consultation between the coxswain, the RCC/MRSC, and the master of the vessel concerned. Removal of persons from other vessels can cover a broad spectrum of incident types; however, the basic techniques employed remain much the same for all types of incidents requiring personnel transfers.

11.16.1 General guidelines

Preparation:

- After determining the need to proceed with a transfer, discuss the intended procedures with the master. Be certain that he or she fully understands your intentions and the actions required from his or her vessel;
- Discuss the intended procedures with the SAR crew. Designate duties;
- PFDs or life jackets must be worn by all personnel involved in the transfer operation;
- Fenders must be placed on both vessels (where practical);
- Consider the use of harnesses or lifelines on deck.

Approach:

- Generally the safest approach is upwind to maintain manoeuvrability on your vessel, except for vessels on fire;
- One crewmember on deck should be designated to communicate with the persons on the distressed vessel. Others should refrain from calling instructions to avoid confusion;
- Fenders should be tended.

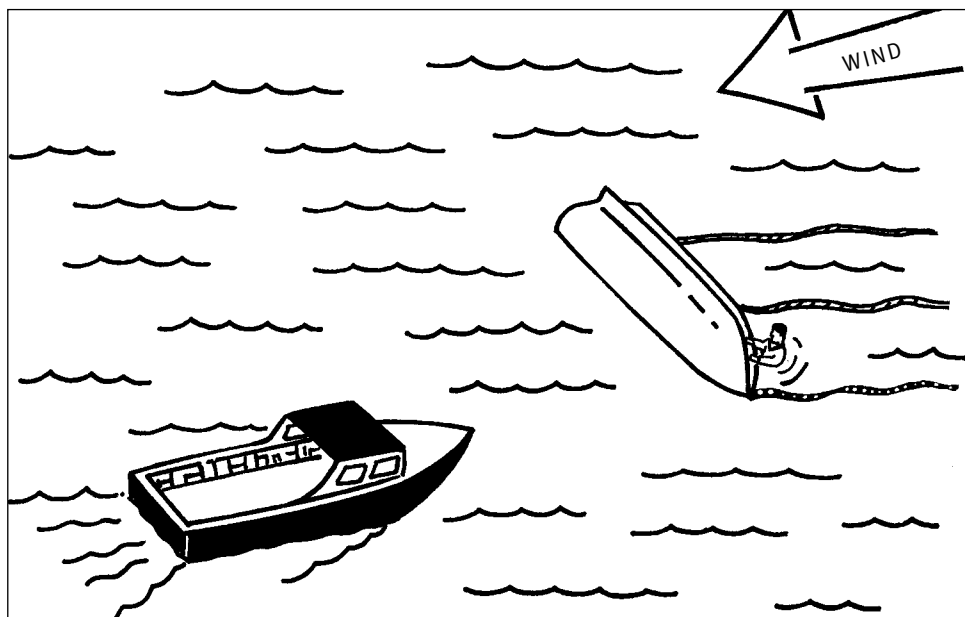

*Figure
11.41:
An upwind
approach*

Transfer:

- In ideal conditions, the SRU may be placed alongside the distressed craft and secured. Lines should be ready to slip quickly as necessary;
- If securing to the distressed craft is not appropriate in the circumstances, manoeuvre your vessel in to touch the craft (preferably at a point where decks are levelled and where seas are not breaking on the vessel) and conduct a quick transfer before manoeuvring away from the craft. Have the designated deck person instruct the rescuer when to step aboard. Have personnel ready to assist the person aboard;
- If coming alongside is not possible, and persons must be transferred, consider removing them using a tender, having them launch and board their life raft, floating a life raft down to them, or passing lines and pulling them to your vessel using life rings or immersion suits. In these circumstances, people are often hesitant to leave the apparent safety and shelter of a vessel to enter a raft or the sea and may have to be coaxed to do so. Be explicit but reassuring in your instructions and guidance. People often do not think of obvious safety precautions under the strain of the situation and may have to be guided through every step of the rescue procedure;
- Rails in the rescue zone may be removed.

11.16.2: Use of life raft for transfer

If the SRU cannot be moved close to the distressed vessel, the SRU's life raft may be used (if available). To conduct the transfer, follow these general guidelines:

- Remove the raft from its stowage position and place it in the water on the lee side of the SRU;
- Pull the painter and inflate the raft;
- Secure to the towing bridle two lines of sufficient length to span the two vessels;
- Pass one line to the persons on the distressed vessel and have them pull the raft to their vessel. As the raft is pulled to the distressed craft, pay out the second line;
- When the raft reaches the distressed vessel, the persons should board it and remove the first line or pull it aboard. (If there is more than one raft of people to be transferred, the persons remaining on the distressed vessel pay out the second line as the raft is pulled to the SRU);
- The SAR crew pulls the raft to the SRU. BE GENTLE. Pull the slack and allow the SRU to drift down onto the raft;
- After recovering the people from the raft, bring the raft aboard and deflate it. Water may have to be removed from the raft before it can be lifted aboard. If it is impossible to recover the raft, consider towing it.

11.16.3 Patients in stretchers

Stretcher patients being transferred from one vessel to another must be fitted with a flotation device and tended with safety lines when appropriate during transfer as a safety precaution for accidental immersion.

Always use your own equipment, if possible. Use the other ship's equipment as a last resort.

If the stretcher is not equipped with a flotation device, put a PFD on the victim, if possible, or on the stretcher.

If circumstances permit, try to avoid strapping the victim into the stretcher during over-water transfers, especially if the stretcher doesn't have the flotation while the victim does. This approach avoids a face-down situation if the stretcher falls into the water.

If there is a person with first aid or medical training, send him or her on board for the preparation of transfer.

Designate one person other than the rescue craft's operator who will oversee the transfer.

11.16.4 Larger ocean-going vessels

Communication is often difficult with foreign vessels because of language and cultural differences. You will have to speak clearly and slowly and listen carefully. Avoid the use of slang or "joke statements" and presume that the listener will interpret all of your statements in the literal sense. Consider communicating through MCTS if necessary.

Note: When dealing with foreign ships in medical evacuations, ensure that RCC/MRSC has notified Customs.

Means of disembarking from the large vessel will vary widely. Common configurations include:

- pilot ladder located either close to the accommodation or near midships as on some tankers;
- accommodation ladders located either close to accommodation or near midships;
- stretcher patients lowered by means of a crane; and
- launching of a lifeboat from the ship to transfer persons to the SRU.

Choose a place where the decks are of similar height. Make a horizontal transfer wherever possible.

The following procedures apply to larger ocean-going vessels:

- Generally, the safest approach is made with the ship forming a lee for the SRU and keeping way on at slow speed as in boarding a pilot. The SRU should not approach until the ship has stopped reversing its screws and all effects of reverse screw race have cleared. The SRU should approach the ship with the side of approach well fendered;
- Advise the ship of your approach;

- Pace with the ship alongside the area of disembarkation and get a feel for the action of the seas. Alter course gently to slip in alongside the point of disembarkation. You may pass a sea painter to the ship if needed. NEVER SECURE TO THE STEM OR OUTBOARD SIDE. THE RESULTING FORCES COULD CAPSIZE THE SRU;
- If you did pass a sea painter, reduce your engine speed slowly and set back on the painter;
- When the SRU is in place, you may initiate the transfer. Crews must be ready on deck to assist those coming aboard. The coxswain may be fully concentrating on keeping the vessel in place at the point of disembarkation and may not be able to perform other tasks. If there are enough crew available, it helps to designate one to handle radio communication during this phase. As with all personnel transfers, only one crewmember on deck should be designated to handle verbal communication at the point of disembarkation;
- When the transfer is completed, sheer off the bow by putting your stern into the ship's side.

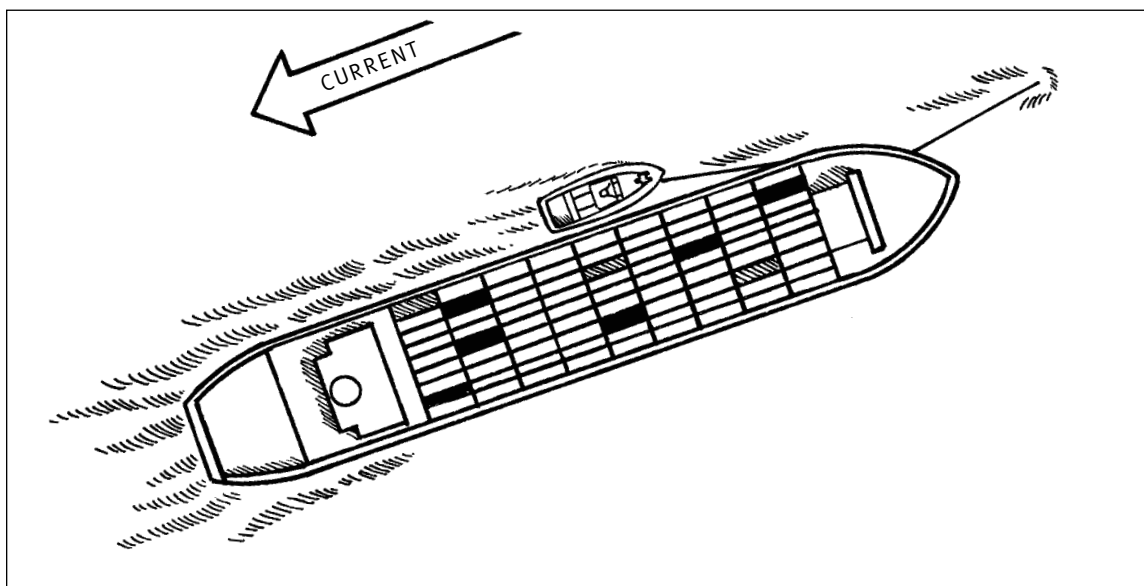

Figure 11.42: Passing a sea painter

Transfers from large vessels generally involve transferring the sick and injured. Use all available crew that you think you require to safely conduct the transfer, and bring along all equipment (extra fenders, etc.) that you may need. Generally, the SAR crew will not know what to expect until on scene.

Be aware that you may have to abort the mission. Transferring patients at sea is a potentially dangerous mission for both the patient and the SAR crew. The degree of need for evacuation must be weighed against the dangers involved in transfer.

Be prepared with a contingency plan. A man-overboard situation could occur.

11.16.5 Passenger ship

Some passenger ships will prefer to evacuate by way of a service door. These doors are usually located near midships and may be 3-4 m (10-13 ft.) above the waterline. The patient may be lowered by crane or davit from the service door, or by climbing down an accommodation ladder.

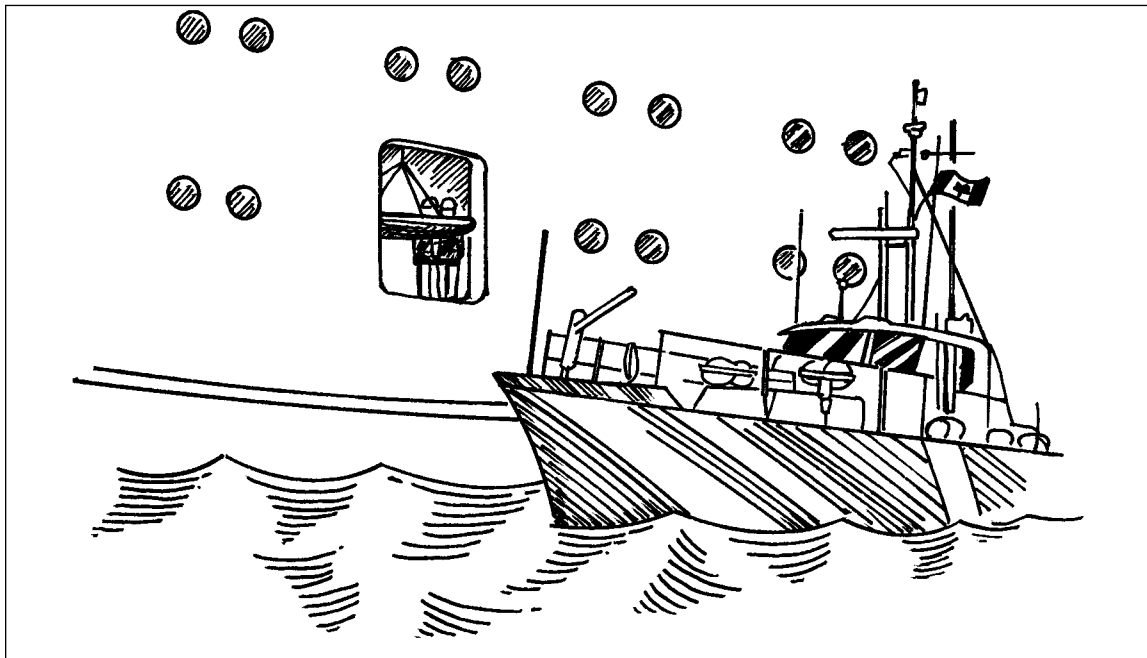

Figure 11.43: Evacuation point on a passenger ship

WARNING

Never approach near the stern of the ship; the SRU may be affected by the ship's screw race, which may suck the SRU toward the ship's stern. With some ships, the SRU may be sucked toward the ship at other points along the ship's side. The coxswain must be aware of these possibilities and ready to counter these actions with his or her vessel.

11.16.6 Ship at anchor

The anchorage will generally have enough current running to require a sea painter. Approach is made from leeward and against the current.

11.16.7 Heavy weather

Transfers in heavier weather conditions may not allow the SRU to rest alongside on a painter. If the coxswain decides to proceed with a transfer, it may be conducted by slipping alongside for a momentary transfer (touch and go). This method requires an alert crew and expert boat handling by the coxswain. Generally the person transferring must be reasonably ambulatory and able to make the step aboard independently. The SRU may have to stay in position at the point of disembarkation for a few minutes, requiring constant station-keeping by the SRU. **DO NOT SECURE TO THE SHIP IN THIS CASE.** After the transfer is completed, the SRU should break away by gently altering course away from the ship's course and slowly increasing power until clear.

11.17 AIRCRAFT RESCUE

11.17.1 Airborne

Aircraft planning to ditch usually report their intentions beforehand. You may be tasked to attend a planned ditching. Ditched aircraft usually sink within minutes.

Seaplanes or float-equipped aircraft commonly transit almost every stretch of water in Canada. In addition, large commercial aircraft use flight paths all across the country. The number of aircraft in service today necessitates SAR operational preplanning for aircraft incidents. (Be prepared for incidents involving large numbers of people by familiarizing yourself with your local Major Marine Disaster Plan or SAR Contingency Plan.)

Some common occurrences with smaller aircraft are:

- structural or mechanical problems which require an SRU on standby during landing on the sea;
- fog or low visibility that may cause the aircraft to land in a dangerous area and require guidance or towing to a safe area by an SRU.

11.17.2 Ditching nearby – general guidelines

Note: In the case of aircraft carrying large numbers of people preparing to ditch, activate your local Major Marine Disaster Plan or SAR Contingency Plan.

- Take extra SAR equipment aboard, (life rafts, first aid, blankets, etc.). Take extra crewmembers, if necessary and immediately available;
- Prepare to provide information to the pilot, including wind direction and speed, sea state, primary and secondary swell size and direction, visibility, and any other pertinent weather information;
- Clear the ditching area of all vessels not involved in the rescue effort. Instruct vessels involved in the rescue effort to stay well clear of the ditching area until the aircraft has stopped and they are instructed to approach the aircraft. In darkness, instruct them not to shine any lights on the aircraft until it has stopped moving on the water. Instruct them to be alert for aviation fuel spilling after the ditching and to avoid any action that produces open flame or spark;
- If requested, transmit signals for the aircraft to take a bearing;
- Prepare heaving lines, life rings, life rafts, tenders, and means of boarding your vessel. Prepare first-aid equipment and blankets. If available, have a rescue swimmer prepare to go over the side;
- The pilot of the aircraft will choose his own ditching heading. If it is made known to you, set your course parallel to his or hers. If the course is not known, set your course parallel to the primary swell and as much as possible into the wind;
- In darkness, turn on all deck lights, turn on blue SAR light, and direct a searchlight vertically. Do not direct any lights toward the aircraft, until it has stopped moving on the water, to avoid blinding the pilot's vision;
- In a prepared ditching, survivors should be wearing aviation life vests. Be alert for survivors in the water and on the aircraft;

- If the aircraft crashes or breaks up on impact, there is a strong possibility of aviation fuel being spilled. Allow no smoking, use of electrical equipment, or outboard motors in the vicinity of the fuel;
- Immediately deploy a datum marker buoy (DMB) at the ditching site to aid in search efforts in case of missing persons. Get an accurate fix on the ditching site. The aircraft may not be afloat long;
- Start rescue efforts immediately. Deploy extra life rafts if you are dealing with large numbers of people, or rescue efforts will take too much time.

11.17.3 Helicopter ditching

A helicopter making a successful ditching will generally still have power or momentum to turn the rotors. Stay away from the rotors until they have stopped turning.

Helicopters have a high centre of gravity, which makes them quite unstable when sitting on the water. In all but the calmest of sea conditions, the aircraft can be expected to roll over. Most helicopters operating offshore in Canadian waters are equipped with emergency inflation bags. (Exceptions are the Sikorsky S-61N and DNDs Labrador, which are equipped with sponsons.) Emergency inflation bags are generally secured to the skids or the underside of the aircraft. During normal operations, the bags are deflated and contained in a protective cover. The bags can be inflated by a control at the pilot's position in the cockpit, which directs a flow of nitrogen or helium to the bags. The purpose of the emergency inflation bags is to allow sufficient time for the occupants of the aircraft to evacuate.

Ditching procedures in a helicopter require persons to remain in their seat with the seat belt fastened if the aircraft rolls over. Once the aircraft has settled in its inverted position, the survivors should start the escape routine.

11.17.4 Aircraft crash – general guidelines

- If large numbers of people are involved, activate your local contingency plan or major marine disaster plan;
- Take extra SAR equipment (life rafts, first aid, blankets, etc.). Take extra crewmembers, if necessary and immediately available;
- Prepare SAR equipment en route. If a rescue swimmer is available, have him or her prepared to deploy;
- AN SRU arriving on scene should deploy a datum marker buoy (DMB), get an accurate fix and notify RCC/MRSC;
- Allow no smoking, open flame, or any means of creating an arc by anyone in the area in case aviation fuel has spilled;
- If the aircraft is afloat, commence removal of survivors immediately. Flag the aircraft with a line and float in case it sinks. If the aircraft has sunk, commence search efforts immediately;
- Deploy life rafts or life rings for temporary survivor support;
- Interview survivors regarding the number of persons aboard and their whereabouts. Ask divers if there are persons trapped inside.

11.18 RESCUE OPERATIONS WITH DND PLANES AND HELICOPTER

11.18.1 Equipment drops

11.18.1.1 Survival Kit Air Droppable (SKAD)

CAUTION

If you are operating near a deployed SKAD, be alert for the polyline in the water.

Fixed-wing SAR aircraft carry survival kits consisting of two 10-man life rafts and two survival containers. These kits are referred to as SKAD kits and can be dropped either to persons in the water or to persons who must abandon their vessel but do not have life rafts. The following procedure will be used:

- The aircraft will make several passes at an altitude of approximately 100-150 m (300-500 ft.) to check the wind drift. It may drop several smoke canisters to check wind speed and direction and mark the target;
- Depending on the target's rate of drift, the aircrew will try to lay the kit in a line either upwind or downwind. All the components of the SKAD are linked by 85 m (280 ft.) of polyline. The objective is to allow the target to make contact with this line so that the components may be hauled in by the line. **DO NOT CUT THE LINE;**
- The rafts will inflate in the air after they are jettisoned out of the aircraft. No parachute is used.

11.18.1.2 Air-droppable pump

An emergency floatable pump kit may be passed to a vessel in need of emergency dewatering by fixed-wing or rotary SAR aircraft. The pump may be dropped by parachute, lowered by hoist, or dropped to an SRU for transfer to the distressed vessel.

11.18.1.3 Parachute drops

CAUTION

When recovering an air-droppable pump, be alert for the recovery line and parachute in the water. Keep them away from your propellers.

- The aircraft will make several low passes dropping smoke canisters to check wind drift and direction and mark the target;
- The pump will be dropped to windward of the target. The objective is to drop the pump attached to a 180 m (600 ft.) line with a drogue at the other end so that the line drifts down onto the vessel and the pump can be pulled aboard with the line;
- The pump canister is orange in colour, weighs 40 kg (90 lb.) and contains a 3.5 hp fire and salvage pump. It also contains oil for the pump, gasoline, intake and discharge hoses, and instructions. The pump can lift water a maximum of 7.5 m (25 ft.) and will run for approximately two hours on 4.5 L (1 gal.) of fuel.

11.18.2 Joint operations with DND helicopters

The main objective of this section is to standardize joint operations involving SRUs and helicopters, and to allow for maximum safety in the conduct of hoisting operations.

The aircraft captain will control the conduct of all hoisting operations, and his or her directions will be followed by the operator of the SAR surface vessel, unless there is evident danger to the vessel or crew in so doing.

Communication may be established on 123.1 MHz VHF-AM prior to commencing a hoisting process. If this frequency is not available, any other mutually agreeable working frequency may be utilized; this frequency should be determined by opening communications on 156.8 MHz (channel 16) or 157.1 MHz (channel 22A). A backup frequency shall also be established. VHF-FM is suitable for this purpose.

Assigned SRU names will be utilized by surface craft. The designator “rescue helicopter” may be utilized to establish communications with an SAR helicopter whose numerical designator is unknown. Once the numerical designator has been determined, the numerical designator will be utilized. For example: “Rescue 307.”

The initial communications between the SRU and the aircraft will be as follows:

- The aircraft commander will advise the SRU of the details of the planned evolution and the number of persons aboard the aircraft;
- The SRU coxswain will advise the aircraft of wind velocity, magnetic direction, and the number of persons aboard the vessel. He or she will also indicate when the SRU is prepared to receive the aircraft for the hoisting process.

11.18.2.1 Preparation of the SRU

Emergency equipment:

- The surface vessel will have readily at hand, away from working areas and properly secured, a fire axe and fire extinguishers.

Personnel:

- Two persons only will normally be on the deck of SRUs during hoisting to assist the SAR technicians to get safely aboard. Non-essential personnel will be off the decks;
- Deck crew shall wear floater suits and protective helmets with chinstraps fastened, and use eye protection and gloves. Safety harnesses shall be utilized as required;
- Crewmembers on deck shall be positioned so as to offer maximum assistance to SAR technicians as they alight on, and leave, the vessel.

Deck equipment:

- All lines and loose equipment shall be secured prior to beginning hoisting;
- Antennae should be so tied as to provide added clearances for the helicopter;
- No searchlight or other glaring light source shall be directed toward the aircraft. No illumination flares or rockets shall be discharged without the prior concurrence of the aircraft commander;

- Ship radar should be selected so that it is not transmitting during hoisting operations to prevent hoisting cable from being tangled with the rotating scanner.

Safety precautions:

- Allow the hook, line or cable from the aircraft to touch the water or the surface vessel prior to handling it, to avoid shock from static electricity. If spilled fuel is present on the deck of the surface vessel, the aircraft must be advised so that it can ground the hoist cable safely;
- Vessels with gasoline stored on deck must be especially cognizant of this cautionary step;
- Beware of lines from the aircraft fouling on the surface vessel. Attach nothing to the vessel that is also attached to the aircraft. Carry no attached equipment inside the vessel;
- Rotor wash can blow personnel overboard. Be aware that it will fill the air with flying spray and reduce visibility. The accompanying noise levels will render voice communication difficult or impossible. Thus, visual signals and leadership amongst deck personnel must be finalized by the coxswain or commanding officer before the aircraft is overhead;
- Injured or sick persons to be hoisted into helicopters will be kept inside the vessel (if possible), not on deck, until the SAR technician is aboard the vessel to supervise their placement in the aircraft's stretcher, which is specially fitted for hoisting. All clothing and lines are to be well secured to avoid fouling of the hoist system of the aircraft.

11.18.2.2 Control of deck operations

Once the military SAR technician is on deck of the SRU, he or she will direct the hoisting process, and SRU crewmembers will follow these directions. All visual signals to the aircraft commander will be given by the SAR technician.

11.18.2.3 Positioning of vessel and conduct of normal hoist process

Figure 11.44: Positioning of vessel for hoist operation

Normally, the vessel will direct her heading 15° to 30° to the right of the surface wind, thus keeping the wind on her port bow. This allows the aircraft commander visual reference to the vessel and places the rescue hoist – which, like the pilot, is located in the starboard forward area of the aircraft – over the vessel's stern. Vessel speed should be five to eight knots. A military SAR technician will usually be lowered directly onto the stern of the vessel to take charge of preparing the person or item to be hoisted into the aircraft, with the assistance of the deck crew of the surface vessel. If the aircraft is unable to lower the SAR technician directly due to weather or sea conditions, a line will be lowered to the surface vessel from the aircraft. When this line has been “grounded” electrically and is held by the surface vessel crew, the aircraft will take up a position clear of the vessel, but still attached to the line extending to the vessel. The SAR technician will then be lowered on the hoist and simultaneously pulled to the surface vessel manually by means of the line held by the vessel. This line will at no time be attached to the vessel.

11.18.2.4 Aircraft engine failure

In the event of aircraft engine failure, the aircraft will break away to the nearest safe area. If a person is on the hoist at this time, the aircraft commander will sever the hoist cable and drop the person into the sea, simultaneously making a decision as to whether to land the aircraft itself in the sea. If such a landing is made, the first priority for the surface vessel crew is to manoeuvre the vessel to avoid damage or injury from the helicopter rotors while picking up the person cut free from the hoist, and assisting the rest of the crew of the aircraft as required.

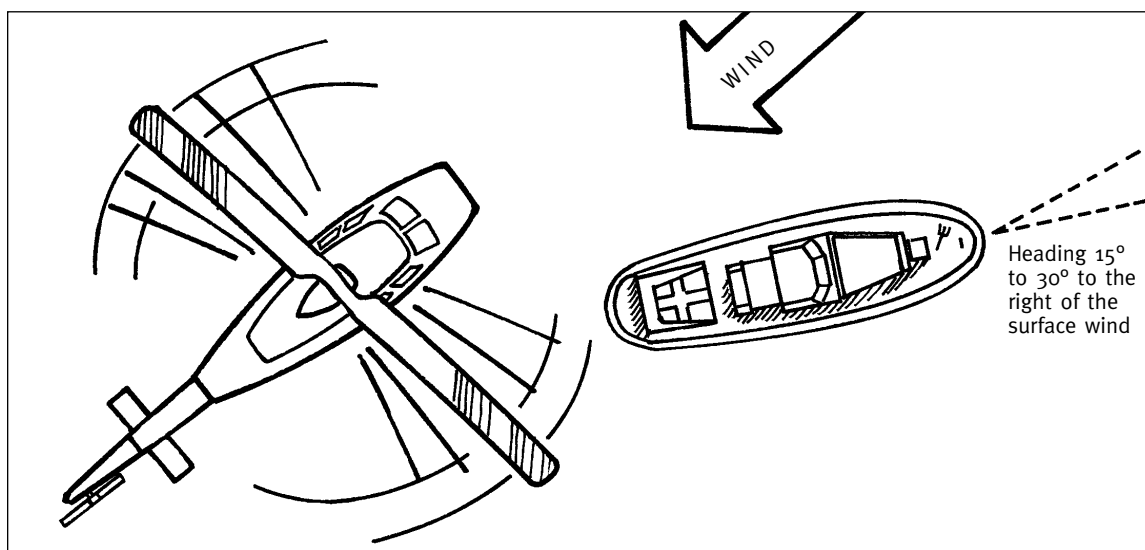
11.18.2.5 Aircraft emergency entry

Generally, the aircraft crew will carry out their own craft's abandonment if necessary, utilizing an on board 10-man inflatable raft for flotation. If assistance must be given by the crew of a surface vessel, do not approach the helicopter while the rotors are still turning. When alongside the aircraft, utilize the information indicated on the attached outline drawing of the Labrador helicopter to determine the best entry route. The entry of choice is the upper portion of the cabin main door indicated in Figure 11.46. Use of this door should retain the watertight integrity of the aircraft, which may be lost if other emergency entrances are opened. However, if necessary, either the emergency exit door, or the escape window panels, may be released by means of external pull tapes. Either the pilot's or copilot's side windows in the cockpit, may be released by first pressing the button on the side window's external handle to activate the spring-loaded emergency release handle. Turn this handle to release the side window.

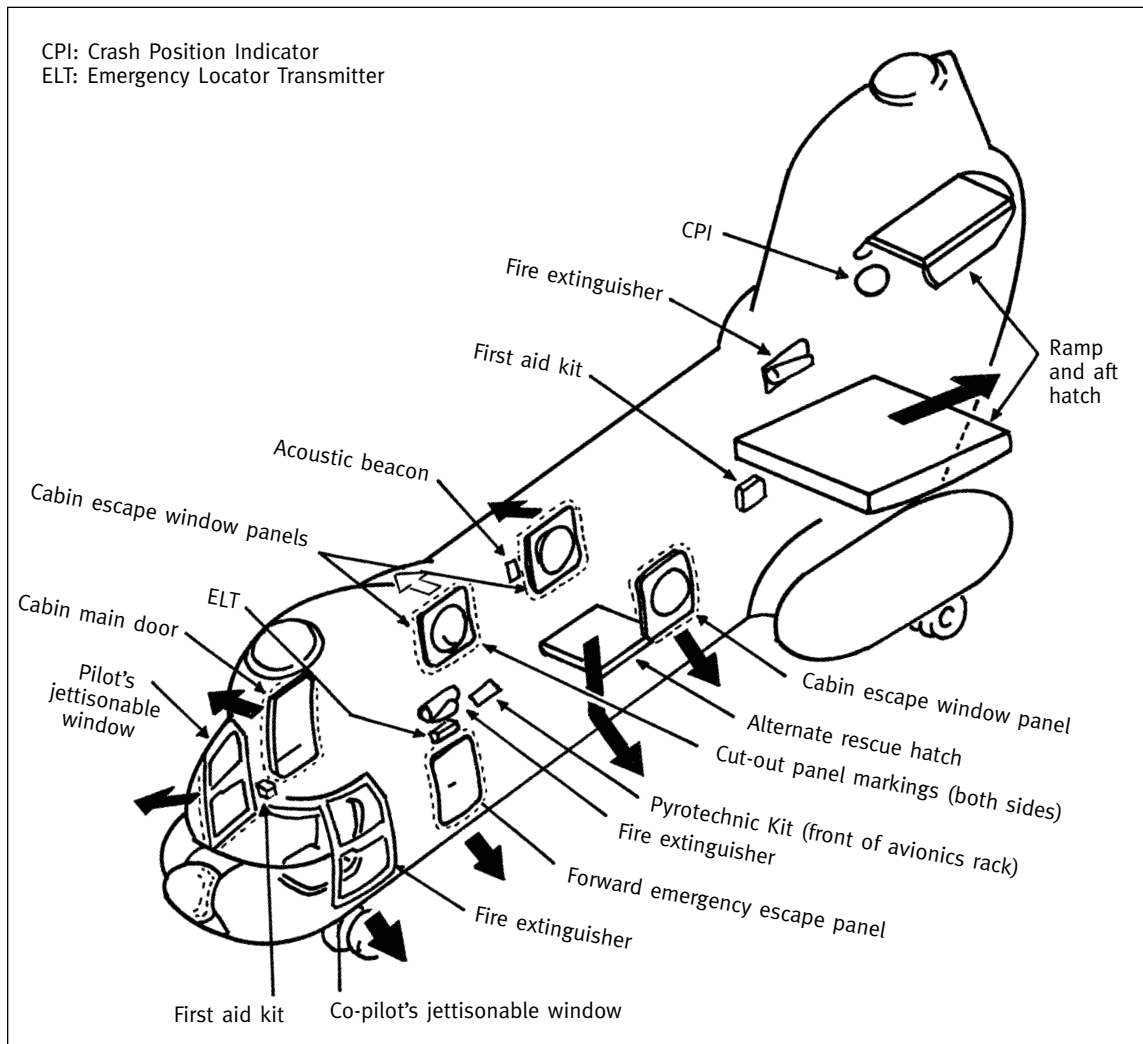

Figure 11.45: Labrador helicopter

11.19 RECOVERING SUBMERGED VICTIMS

Recovery of submerged victims may be quite difficult and hazardous for the untrained rescuer. Under no circumstances should any untrained rescuer, including certified scuba diver, attempt to enter the water to recover a submerged victim. Statistics show that untrained rescuers attempting such recoveries often die or get injured in the process. Submerged victims quite often have very little chance of survival. It is not advisable to risk the life of a crewmember to rescue someone that may already be dead. In those situations, the only rescue actions available to you are those that can be performed from the deck of your unit.

11.19.1 What agencies can recover victims?

When a submerged victim needs to be recovered, Coast Guard or Coast Guard Auxiliary units contact RCC/MRSC and ask for the assistance of trained professional divers. The following government agencies may provide divers for the purpose of recovering submerged victims:

- municipal or provincial police departments;
- RCMP;
- fire departments;
- Department of National Defense;
- some professional diving agencies or specialized rescue squads.

Recovering a dead person

Many persons still die at sea and, unfortunately, bodies are not always recovered during the initial search operation. When the conditions permit, drown victims may refloat after a period of submersion. Vessels engaged in SAR can be dispatched to recover dead bodies. When doing so, it is essential to follow proper procedures to avoid contamination and to facilitate legal issues.

11.19.2 General guidelines

When recovering a body, follow these guidelines:

- If possible and practical, have a police officer on board during body recoveries. Ensure that police officers and morgue personnel will be waiting for you at the delivery point;
- Wear protective gear (goggles, masks and long rubber gloves) before approaching the body;
- Manipulate the cadaver with metal or plastic poles (or boat hooks). Wood should be avoided, since it will not be easy to disinfect afterward;
- Do not directly handle the body;
- Try to keep the cadaver away from your unit. Avoid any direct contact if possible ;
- Be careful when handling the cadaver in order to protect the integrity of the body, in case of further investigation by legal authorities. In case of doubt, try to contact the closest coroner's office;
- It is paramount to keep in mind that this is a very emotional time for the family of the victim. In this regard, the body needs to be treated with the utmost respect and dignity;
- Communications must be conducted with the proper terminology when reporting bodies;
- If identification is present in the pockets of the body's clothes, try to recover it before towing. Anything removed from a body should be stored in a sealed bag. Remember to hand over the bag when transferring the body to the proper authorities;
- Tow the body at reduced speed. Avoid towing against the current. The body may be fragile and may lose pieces if towed at high speed;
- On arrival at destination, leave the body in the water until the proper authorities arrive. Avoid any contact between the body and the dock;

- After the operation, wash everything that came in contact with the body with soap and disinfect with a solution of water and bleach ($\frac{1}{4}$ cup of bleach per gallon of fresh tap water). Used rubber gloves should be replaced;
- Unless the SAR unit is fully equipped with body bags and protective gear, we recommend towing the body away from the boat. Never take a body on board when you do not have the appropriate equipment.

11.20 MISSION CONCLUSION

Once the mission is concluded:

- Inspect the equipment used during the mission;
- Prepare the unit for another mission (tidy and clean it up);
- Refuel your unit;
- Follow local procedures regarding SAR paperwork;
- Conduct a debriefing to identify the strong and weak points of your mission;
- Ensure crew readiness (rest, eat and drink if needed).

Note: Additional information on debriefings can be found in Chapter 2 (Human Factors).

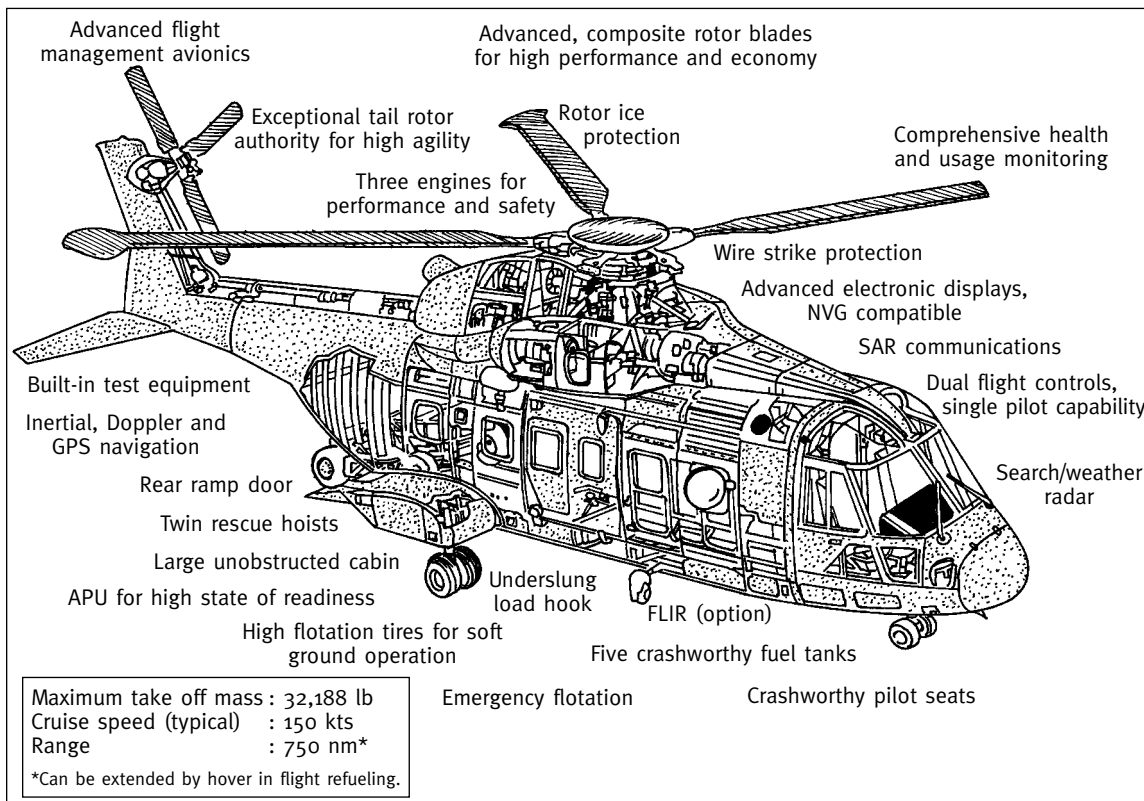

Figure 11.46: The new Cormorant SAR helicopter

CHAPTER 12 – EMERGENCY CARE AND TRANSPORTATION OF MARITIME CASUALTIES

12.1	Medical emergencies12-5
12.1.1	Information gathering	I2-5
12.1.2	Responding to the incident	I2-5
12.1.3	Communication with casualty vessel	I2-5
12.1.4	Arrival on scene	I2-6
12.1.5	Decision Point	I2-6
12.1.6	Stabilizing patient	I2-6
12.1.7	Transfer	I2-7
12.1.8	Transport	I2-7
12.1.9	Ambulance reception Point	I2-7
12.1.10	Hand-over to the ambulance	I2-8
12.2.	Water extrication12-9
12.2.1	Some sample methods of water extrications	I2-9
12.2.1.1	Single or multiple person manual lift	I2-9
12.2.1.2	Plastic spine board or Miller board	I2-9
12.2.1.3	Plastic basket stretcher	I2-9
12.2.1.4	Parbuckling or net rolling	I2-10
12.3	Hypothermia12-11
12.3.1	Mild hypothermia (non life-threatening)	I2-11
12.3.2	Severe hypothermia (life-threatening)	I2-11
12.4	Cold water near drowning12-12
12.4.1	Factors in survival of cold water near-drowning	I2-13
12.4.2	Additional factors in long-term submersion	I2-14
12.4.3	Body reactions and responses to cold (autonomic or automatic)	I2-14
12.4.4	Medical management and transport of the cold water near-drowning victim	I2-15
12.4.4.1	Basic life support rescue from the water	I2-15
12.4.4.2	Rescue breathing	I2-15
12.4.4.3	Chest compressions	I2-16
12.4.4.4	Advanced cardiac life support	I2-16

12.4.5	Apparent signs of death	I2-I8
12.4.6	Re-warming procedures	I2-I8
12.4.7	Contamination with oil	I2-I9
12.5	Diving related injuries (SCUBA, etc.)12-19
12.5.1	Physiology of diving	I2-I9
12.5.1.1	Decompression	I2-20
12.5.2	Common diving emergencies	I2-21
12.5.2.1	Barotrauma	I2-21
12.5.2.2	Ear barotrauma	I2-21
12.5.2.3	Sinus barotrauma	I2-22
12.5.2.4	Tooth barotrauma	I2-22
12.5.2.5	Digestive tract barotrauma	I2-22
12.5.3	Air embolism, decompression sickness and bends	I2-22
12.5.3.1	Air embolism	I2-22
12.5.3.2	Decompression sickness (DCS) and bends	I2-23
12.5.4	Guidelines for the treatment of divers	I2-23
12.5.4.1	Remove the diver from the water	I2-23
12.5.4.2	Special considerations – recovering technical divers	I2-24
12.5.4.3	Undressing an injured or unconscious diver	I2-25
12.5.4.4	Determine the nature of the problem	I2-25
12.5.4.5	Organize transport to a recompression chamber	I2-26
12.5.4.6	Place the victim in the appropriate position	I2-26
12.5.4.7	Perform a secondary survey and treat all other injuries	I2-26
12.6	Multi-casualty situations12-26
12.6.1	Triage	I2-26
12.6.1.1	General rules of triage	I2-27
12.6.2	Casualty evaluation	I2-27
12.6.3	Priorities for treatment and evacuation	I2-28
12.6.3.1	Urgent category (red)	I2-28
12.6.3.2	Delayed category (yellow)	I2-28
12.6.3.3	Minor category (green)	I2-28
12.6.3.4	Deceased category (black)	I2-28
12.6.4	The tagging system	I2-29
12.6.4.1	The tagging of casualties	I2-30
12.6.4.2	Triage tags	I2-31

12.6.5	Multi-casualty first aid	I2-3I
12.6.5.1	Airways	I2-3I
12.6.5.2	Breathing	I2-3I
12.6.5.3	Circulation	I2-3I
12.6.5.4	Deadly bleeding	I2-32
12.6.5.5	Hypothermia	I2-32
12.6.5.6	Shock	I2-32
12.6.5.7	Long bone fractures	I2-33
12.6.5.8	Burns	I2-33
12.7	Spinal injuries	12-33
12.7.1	Cervical spine	I2-33
12.7.2	Spinal immobilization techniques	I2-33
12.7.2.1	Using rigid cervical collars	I2-34
12.7.2.2	Using spinal immobilization devices	I2-34
12.7.2.3	Spine boards	I2-34
12.7.2.4	Kendrick Extrication Device (KED)	I2-36
12.7.2.5	Miller board or litter	I2-36
12.7.3	In-water spinal injuries	I2-37
12.8	Care of rescue craft survivors	12-38
12.8.1	Survival at sea	I2-38
12.8.2	Medical problems encountered with survivors	I2-38
12.8.2.1	Seasickness	I2-38
12.8.2.2	Sunburn	I2-38
12.8.2.3	Dehydration and malnutrition	I2-38
12.8.2.4	Heat exhaustion	I2-38
12.8.2.5	Heat cramps	I2-38
12.8.2.6	Cold exposure injuries (local)	I2-39
12.8.2.7	Chilblains	I2-39
12.8.2.8	Immersion foot	I2-39
12.8.2.9	Frostbite	I2-40
12.9	External assistance	12-41
12.9.1	Medical advice	I2-4I
12.9.2	Signs of death	I2-4I
12.9.2.1	Only a doctor can declare a patient dead	I2-4I
12.9.3	Use of a camera	I2-42

12.10	Transportation of casualty in Fast Rescue Craft	12-42
12.10.1	Limitations of Fast Rescue Craft	12-42
12.10.2	Methods of Immobilization in FRC	12-43
12.10.3	Artificial Respiration (AR) and CPR in FRC	12-44

12 EMERGENCY CARE & TRANSPORTATION OF MARITIME CASUALTIES

CAUTION

This section is not intended to be a first aid course. Rather, it provides guidelines for emergency care and transport of patients in a marine environment. Most of the first aid standards and recommendations presented in this chapter are directly taken from the following references: *First Aid on the Scene* (St. John Ambulance) and *SAR Skill Training Standards* (Canadian Coast Guard – TP-9224).

12.1 MEDICAL EMERGENCIES

Basic First Aid and CPR courses train first aiders to provide basic life support to patients until the ambulance arrives. However, in a marine environment, the ambulance will not be able to come to the patient. Therefore, the responding SAR vessel must bring the patient to the ambulance, providing first aid care along the way.

12.1.1 Information gathering

When tasked to respond to a medical emergency, try to gather as much pertinent information as possible:

- description of patient (age, sex, etc.);
- chief complaint (e.g., chest pain, shortness of breath, pain from injury);
- history of chief complaint (e.g., fall, cardiac patient);
- care being given now. (e.g., CPR).

This information will help determine:

- equipment required (e.g., splints, oxygen);
- speed of response required;
- level of expertise required (e.g., EMT);
- whether unit is able to respond alone or additional units will be required.

12.1.2 Responding to the incident

While speed of response is important in a medical situation, care must be taken to ensure that the responding vessel departs with all required equipment and personnel. The oxygen kit left on the dock is of little use to a patient in shock.

Routing to the incident location should be carefully considered. The shortest route is not always the safest. The patient will not benefit from a rescue craft that has run aground in a narrow passage. Also, the sea state will be a factor in the speed of transit. While the vessel may be capable of high speed in heavy seas, the crew may be unnecessarily fatigued or even injured if the craft operator tries to maintain that high speed.

12.1.3 Communication with casualty vessel

It is important to establish and maintain communications with the casualty's vessel. They can keep you informed of the vessel's current position, change of patient's condition and any other relevant conditions, such as changes in the weather.

12.1.4 Arrival on scene

Once on board the casualty's vessel, perform a **Scene Survey**. Assess hazards and ensure the area is safe. If the area is not safe, **do not** enter until the hazards are removed. Confined spaces are particularly hazardous, as toxic gases may accumulate there or oxygen may be deficient.

Perform a **Primary Survey** of the patient (A, B, C's) to identify any life-threatening injuries or illnesses.

As always, priorities are:

- spinal injuries;
- level of consciousness;
- an open airway;
- adequate breathing;
- presence of a pulse;
- severe bleeding;
- major fractures.

Treat for shock. Minimize the onset of shock by keeping patient warm, positioning for comfort, treating injuries, reassuring patient and administering oxygen, if you are trained to do so.

12.1.5 Decision point

At this point, a transport decision based on the patient's condition should be made. Patients with life-threatening injuries or illnesses need to get to medical facilities within the "Golden Hour." The "Golden Hour" refers to the time elapsed from the time of injury or onset of medical emergency until the casualty is in a medical facility. It has been demonstrated that patients have the best chance of recovery if they receive treatment within this hour. Rescuers may need to consult with RCC/MRSC and the receiving ambulance to determine the best method of transport, which could be aircraft or a larger, more stable vessel.

12.1.6 Stabilizing patient

Before transferring the patient to the rescue craft, stabilize life-threatening conditions such as:

- obstructed airway;
- respiratory/cardiac arrest;
- head and spinal injuries;
- major bleeding;
- major fractures;
- unstable chest injuries;
- evisceration;
- major burns;
- severe shock.

Any patient that is not fully conscious and able to move easily should be secured in a stretcher (if available) in a comfortable position. Always consider airway and drainage. Patients with fractures, head or spinal injuries should be firmly secured to a padded spine board before they are transported. This is especially important in rough sea conditions.

12.1.7 Transfer

Great care should be taken to protect the patient during boat-to-boat transfers. The patient should be wearing flotation if possible and stretchers must be equipped with flotation and a safety line.

Try to position the patient within the craft to minimize the effects of motion. The layout of your particular vessel will dictate possible positions.

DO NOT delay transport for the secondary assessment unless the victim can be classified as “stable.”

12.1.8 Transport

Once the victim is carefully positioned, you may proceed toward the casualty reception point. Transit time should be used to complete a secondary survey and to treat the non life-threatening injuries of casualties needing quick transport (potentially unstable and unstable victims). Try also to periodically reevaluate vital signs (level of consciousness, breathing and pulse). Be aware that this assessment may become a difficult task due to noise and vibrations (especially at high speed). Confirm with RCC/MRSC that an ambulance is waiting for you at the designated evacuation point. As for the transit to the scene, use the quickest route. Try to write your observations and actions on the relevant form to inform paramedics and physicians of happened and what was done.

For less urgent situations, transit time can be used to complete emergency treatments and to complete the written patient care form.

Transit speed should be fast but safe. Maximal transit speed will depend on several factors, including sea state and casualty's condition. The nature of the emergency care that you must provide will also have an influence on transit speed. For example, it might be impossible to perform CPR adequately if you are going at 35 knots in 6 ft. seas! Transit speed should thus be a compromise between the need for quick transport and the necessity of keeping the casualty alive during transit. Under no circumstances should your speed prevent the administration of life-preserving emergency treatment.

12.1.9 Ambulance reception point

During transit, choose an appropriate location for transferring the patient to the ambulance. Try to choose a location that provides easy access for the ambulance and the rescue craft. Since ambulance dispatchers and crews are not usually familiar with nautical charts and terms, landmarks such as street names, businesses or house numbers may have to be used to pinpoint landing sites. A list of prearranged reception points in your area should be compiled in conjunction with the local ambulance service. This could help avoid confusion and save precious time during a medevac.

12.2 WATER EXTRICATION

Removing a casualty from the water requires skill and should be practiced on a regular basis under controlled conditions.

It may be difficult for larger vessels to safely manoeuvre alongside a person in the water, and high freeboards make lifting of the person difficult and dangerous. If conditions allow, a small boat should be launched and used to pick up the casualty. A small boat allows the rescuers to extricate the casualty from the water with a greater degree of care.

In these circumstances, the first aid priorities are:

- removing the casualty from danger (cold water);
- an open airway (not possible if a person is floating face down);
- breathing;
- pulse;
- severe bleeding;
- spinal injury should always be considered, but should not supersede the above priorities.

12.2.1 Some sample methods of water extrications

12.2.1.1 Single or multiple person manual lift

Take hold of the casualty, bring them alongside the boat, and pull them up onto the gunwale or tubes of the boat. Then turn the casualty into a horizontal position and, supporting the head and neck, roll them gently onto the deck. A very heavy casualty, or a casualty wearing light or no clothing will be difficult to lift. A bight of line passed around the casualty's chest and back under the armpits may help facilitate the lift.

12.2.1.2 Plastic spine board or Miller board

The casualty may be secured to a plastic spine board or Miller board, if readily available. This will provide a good degree of spinal immobilization and will aid rescuers in pulling casualty aboard. However, this procedure takes time to apply and is difficult in rough water.

12.2.1.3 Plastic basket stretcher

This works similarly to a spine board, but does not require the casualty to be strapped in, which makes the operation easier and quicker;

12.2.1.4 Parbuckling or net rolling

This is a useful technique when the casualty is very heavy. Affix two strong lines to the inside of the boat about 1 m (3 ft.) apart. Run the lines over the gunwale and under the horizontal casualty. Position the lines to run across the upper chest and mid thigh and then back to the rescuers. Pulling evenly on the lines will cause the casualty to roll up over the gunwale and into the boat. A net also works well for this manoeuvre. This manoeuvre also works well if the casualty is secured to a Miller board.

Once casualty is securely on board, conduct a normal **Primary Assessment**.

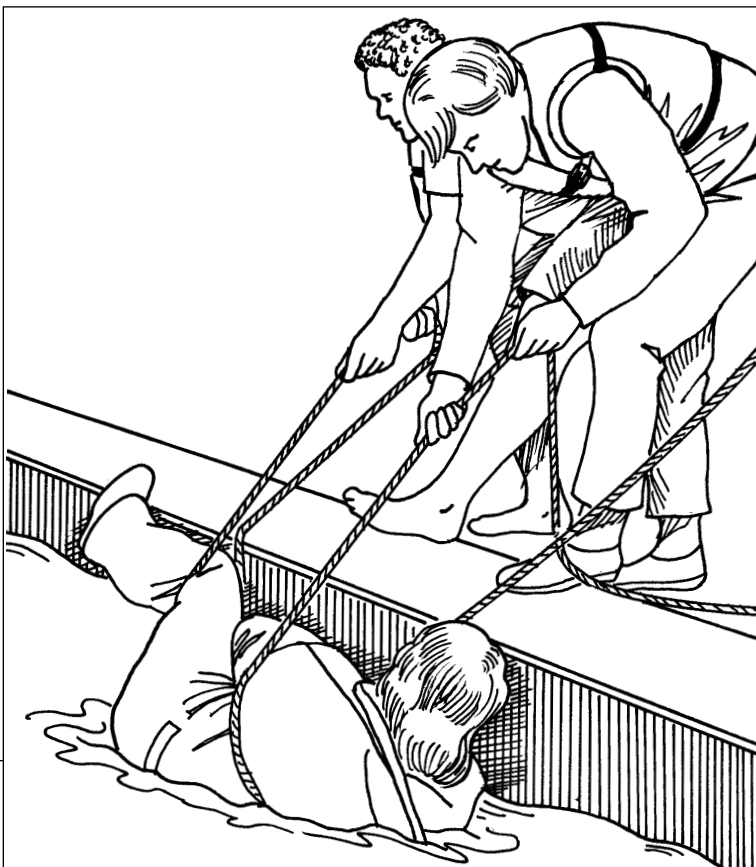

Figure 12.2:
Parbuckling techniques

12.3 HYPOTHERMIA

Forced immersion is the primary hazard to life once the victim survives the initial impact of hitting the water. It should be kept in mind that no ocean or lake has a temperature equal to body temperature. Thus, in all latitudes, anyone in open water will lose heat, and heat loss lowers the internal body temperature. As the internal body (core) temperature falls below normal and generalized hypothermia develops, there is an increasing likelihood of ventricular fibrillation and cardiac arrest.

The loss of body heat is one of the greatest hazards to the survival of a person in the sea.

The water temperature and the length of exposure determine the extent to which generalized hypothermia threatens life. The bodily effects of subnormal temperature will vary depending on geography, season, duration and activity in the water, and body insulation (the amount of fatty tissue and clothing on the individual).

Once the primary survey and interventions are taken care of, consider hypothermia. It may be safely assumed that anyone who has been accidentally immersed in water will have some reduction in body temperature, however slight. While there are many clinical stages of hypothermia, it is only necessary to differentiate two in the field.

12.3.1 Mild hypothermia (non life-threatening)

Signs of mild hypothermia are:

- casualty feels cold or even numb;
- shivering, possibly quite violently, but able to stop shivering voluntarily;
- able to speak normally and answer questions appropriately;
- fine motor skills such as using hand tools or operating a radio may be slightly impaired, but large motor skills such as walking are unaffected.

Treatment involves removing casualty from the cold, removing wet clothing and providing warm blankets or clothing. Warm, sweet drinks or a hot meal will help provide fuel to help the body warm itself.

Watch for any signs of change of level of consciousness, which may indicate a dropping core temperature.

12.3.2 Severe hypothermia (life-threatening)

Even if the casualty has been exposed to cold water for a short time, severe hypothermia is possible. If any of the following signs is present, the casualty should be considered severely hypothermic:

- casualty is shivering violently and unable to stop voluntarily, or shivering may be absent;
- slurred speech, inability to answer questions appropriately, confusion, sleepiness;
- staggering, clumsiness, appearance of drunkenness;
- any other sign of reduced level of consciousness;

- unconsciousness;
- total unresponsiveness;
- rigidity;
- absence of breathing, pulse;
- bluish or white skin, cold to the touch;
- casualty may appear dead.

First and foremost, the casualty must be treated very gently. A reduced body core temperature increases stress on the heart. Rough handling may cause further stress and cause the heart to beat erratically or even stop. If casualty is unconscious, assess airway and breathing. If no breathing is detected, begin rescue breathing using mouth to mask method (with oxygen if available, and if you are trained for its use). Check the carotid pulse. Severe hypothermia will make detecting a pulse very difficult, so great care must be taken to determine whether a pulse is present. Administering chest compressions over a weakly beating heart may cause erratic heartbeat (ventricular fibrillation) or full arrest. Rescuers should take at least two minutes to look for a pulse before starting chest compressions.

If the casualty cannot be immediately moved to shelter, wrap in space blankets or tarps to slow down heat loss due to evaporation. Once you have moved the casualty to shelter, remove all wet clothing, wrap him or her in warm blankets and apply chemical heat packs to the high heat-loss areas such as the groin, armpits, chest, head and neck. If an Inhalation Warming Unit (Res-Q-Air) is available, a trained rescuer should apply it. If casualty is fully conscious, warm sweet drinks without caffeine or alcohol may be given. Do not put casualty into a hot bath or shower, and do not rub the extremities to warm them up.

Casualty must be transported to a medical care facility as soon as possible.

Note: Even if casualty appears dead, basic life support should be started and maintained. The sudden exposure to cold can help to preserve the body, and this person may have a chance of recovery. Never give up!

12.4 COLD WATER NEAR DROWNING

Drowning is defined as death from suffocation due to submersion. The major causes of drowning include the following:

- becoming exhausted in the water;
- losing control and being swept into water that is too deep;
- losing a support (such as a boat that has sunk);
- becoming trapped or entangled while in the water;
- suffering hypothermia;
- suffering trauma;
- having a diving accident.

Cold water near-drowning is defined as survival, at least temporarily (24 hours) from near suffocation due to submersion. Water is considered cold at less than 20°C (68°F).

12.4.1 Factors in survival of cold water near-drowning

Persons underwater in a hypothermic condition for up to (and sometimes more than) one hour may be alive, yet they may have no observable vital signs. The following general guidelines are applicable as an indication of potential survival conditions:

- The colder the water, the better. The less warmth there is in the body, the less oxygen is needed to maintain metabolism. The body requires 50% less oxygen for each 1°C reduction in internal temperature. Therefore, at approximately 15.5°C (60°F), oxygen requirements for cellular maintenance are one fourth those of normal temperature levels. Note that this requirement is simply for cell maintenance, not overall physical activity;
- Moving water also cools faster than standing water. This factor must be added to the balance when ambient air and water temperature and time of year are considered in calculating survival chances;
- Note that water depth usually correlates with coldness. Temperature drops as you descend. For instance, during the summertime in a 1.2 m (4 ft.) deep aboveground pool, there might be as much as a 5.6° to 8.4°C difference between surface and bottom temperature (when the pool's pump and filter system are off and not mixing layers of water);
- Smaller objects lose heat faster than larger objects. In children, these heat loss rates can mean a body temperature of 27°C (80.6°F) after 20 minutes submersion in 27°C water. (Children have comparatively larger skulls than adults, and most heat loss occurs in the neck and above.) This profile may also extend underwater survival potential for children;
- The younger the person, the better. Children apparently tolerate hypoxia better than adults do. Even after resuscitation, a child's brain continues to grow, and this progression may allow compensation for near-drowning-induced cerebral damage. Also, because of larger surface area-body mass ratios, children cool much more quickly in hypothermic water accidents, which helps them to survive longer;
- The cleaner the water, the better. Contaminants or biological growths ingested into the lungs frequently cause massive infections following pulmonary injuries after the initial immersion incident;
- The shorter the time underwater, the better;
- The less the victim struggles in the water, the better. If the victim submerges with a minimum of struggling, his or her bloodstream and lungs retain more oxygen for cellular maintenance;
- A number of older individuals have been resuscitated after up to 40 minutes submersion, with some of these cases occurring in southern waters during summer months.

12.4.2 Additional factors in long-term submersion

Two general processes are apparently involved in protecting submerged individuals:

- The physiology of drowning. Drowning humans instinctively perform acts that increase the oxygen loading available to their lungs. They automatically create as large and as clear an airway as possible and move their arms in a manner that expands their lungs. Notwithstanding the fact that they are struggling and therefore burning oxygen, the struggling is performed in a manner that maximizes oxygen uptake.

Also, depending on the position of the face relative to the water's surface, torso reflex, or sudden, automatic inhalation when entering a cooled environment above the water, may be seen as another method provided by nature to maximize lung oxygen loading.

- **Diving reflex.** Some triggering agent accomplishes the two primary effects normally attributed to dive reflex: (1) redistribution, or shunting, of cooled blood from the exterior to the interior of the body, (2) rapid reduction of metabolism, (3) sudden bradycardia (decreased heart rate), (4) spleen contractions (this will increase the amount of red blood cells in the circulation), etc. The first effect produces an increased level of oxygen in certain parts of the body, primarily the heart, lungs, and brain. The other effects further slow the rate of oxygen consumption. The presence of these factors in many types of diving mammals such as whales and seals is undisputed and has been proved by the surgical insertion of monitoring devices. In humans, a similar (but weaker) reflex is triggered by facial immersion in cold water. Special receptors located on the forehead will sense the variation of temperature and induce the diving reflex. The greater the variation of temperature, the greater the diving reflex. Bradycardia can easily be observed at home by monitoring the pulse while immersing the face in icy water.

12.4.3 Body reactions and responses to cold (autonomic or automatic)

Peripheral Vasoconstriction (PVC)	Shivering: from approximately 30.5°–36.6°C (87°–98°F)	Physiological shut down
Body temperature falls approximately 1/2°F below normal.	If body heat loss not reduced by PVC, involuntary exercise begins.	If heat loss not reduced, shivering stops, remaining heat is drastically conserved.
Blood vessels in periphery (directly beneath skin) begin to contract, reducing heat radiated to air.	Ten times as much heat production results from rapidly expanding and contracting muscles as during resting state.	Body and brain begin to shut down; vital signs diminish, cells shift to maintenance oxygen levels.
Blood begins to be trapped in periphery; sets initial stage for "afterdrop."	If heat loss continues, blood becomes acidotic, with buildup of toxic exertion byproducts.	Victim may appear to be dead, with severe potential for harm to internal organs as a result of perfusion by toxic blood.

12.4.4 Medical management and transport of the cold water near-drowning victim

Your responsibilities toward a potential victim of drowning follow:

- Rescue and remove horizontally victim from the water as soon as possible;
- Initiate CPR as soon as practicable, maintaining it until relieved by higher authority;
- Provide 100% oxygen, warmed and given through a nebulizer if available. If not, give the highest possible percentage with the appropriate mask;
- Transport victim to a clinical facility as rapidly as you can;
- Remove victim's wet clothing; insulate and protect him or her from wind chill.

12.4.4.1 Basic life support rescue from the water

When attempting to rescue a near-drowning victim, the rescuer should get to the victim as quickly as possible, preferably with some conveyance (boat or flotation device). The rescuer must always be aware of personal safety in attempting a rescue and should exercise caution to minimize the danger.

12.4.4.2 Rescue breathing

Initial treatment of the near-drowning victim consists of rescue breathing with mouth-to-mask technique. Rescue breathing should be started as soon as the victim's airway can be opened and protected and the rescuer's safety can be ensured.

In a shallow water diving accident, neck injury should be suspected. The victim's neck should be supported in a neutral position (without flexion or extension) with the use of a rigid cervical collar whenever possible, and the victim should be floated supine on a back support before being removed from the water. If the victim must be turned, the head, neck, chest, and body should be aligned, supported, and turned as a unit to the horizontal, supine position. If artificial respiration is required, rescue breathing should be provided with the head maintained in a neutral position; i.e., jaw thrust without head tilt or chin lift without head tilt should be used.

Immediate ventilation and rescue breathing should be initiated if the submersion victim is not breathing. (Some references suggest assessing pulse and respiration for two minutes because they may be very slow and difficult to detect. If the pulse is present, CPR initiated in error will likely precipitate ventricular fibrillation. Though not recommended for warm patients, a **two-minute pulse check** is appropriate for severely hypothermic patients given the difficulty in obtaining a pulse and the reduced rate of cell death in cold tissue.) Management of the airway and ventilation of the submersion victim are similar to those of any victim in cardiopulmonary arrest. There is no need to clear the airway of aspirated water. However, rescuers may need to remove debris, gastric contents, or other foreign materials using standard techniques for obstructed airway. Usual airway management with adjuncts, such as pocket masks and oropharyngeal airways, can be accomplished in the near-drowning victim. At most, only a modest amount of water is aspirated by the majority of both freshwater and seawater drowning victims, and freshwater is rapidly absorbed from the lungs into the circulation.

Furthermore, 10% to 12% of victims do not aspirate at all because of laryngospasm or breath holding. An attempt to remove water from the breathing passages by any means other than suction is usually unnecessary and apt to be dangerous because it may eject gastric contents and cause aspiration.

Abdominal compressions (Heimlich manoeuvre) delay initiation of ventilation and breathing. Their value is not proven scientifically and supported only by anecdotal evidence, and their risk-benefit ratio is untested. Therefore, abdominal compressions should be used only if the rescuer suspects foreign matter is obstructing the airway or if the victim does not respond appropriately to artificial ventilation. Then, if necessary, CPR should be re-instituted after abdominal compression has been performed. Abdominal compressions are performed on the near-drowning victim as described in the treatment of foreign-body airway obstruction (unconscious supine), except that in near-drowning the victim's head should be turned sideways unless cervical trauma is suspected.

12.4.4.3 Chest compressions

Chest compressions should not be attempted in the water because the brain is not perfused effectively unless the victim is maintained in the horizontal position and the back is supported. These conditions cannot usually be met in the water.

After removal from the water, the victim must be immediately assessed for adequacy of circulation. The pulse may be difficult to appreciate in a near-drowning victim because of peripheral vasoconstriction and a low cardiac output. If a pulse cannot be detected after a careful, two-minute pulse check, chest compressions should be started.

12.4.4.4 Advanced cardiac life support

Every submersion victim, even one who requires only minimal resuscitation and regains consciousness at the scene, should be transferred to a medical facility for follow-up care. It is imperative that monitoring of life support measures be continued enroute and that oxygen be administered if it is available, since lung injury may develop up to several hours after submersion. Although survival is unlikely in victims who have undergone prolonged submersion and require prolonged resuscitation, successful resuscitation with full neurological recovery has occurred in near-drowning victims with prolonged submersion in cold water. Since it is often difficult for rescuers to obtain an accurate time of submersion, rescuers at the scene should initiate attempts at resuscitation unless there is obvious physical evidence of death (such as putrefaction). The victim should be transported with continued CPR to an emergency facility where a physician can decide whether to continue resuscitation.

Here are some factors to consider as you decide whether to continue resuscitation:

In the past, the time limit to achieve positive results from resuscitation efforts has been one hour underwater. However, several considerations temper this limit, and it may be expandable.

First, timekeeping before the information is inserted into an emergency response system is usually sketchy at best. Time seems to pass slowly for people involved in emergencies. Second, in at least two North American cases (a 2 1/2-year-old girl revived on June 10, 1986, near Salt Lake City, Utah, after 66 minutes under water and another 3-year-old girl resuscitated in November 1980 in Alaska after apparently being submerged for 63 minutes), complete recovery occurred in victims whose documented time underwater was 60 to 70 minutes. This means that your timekeeping should err on the broader rather than the narrower side. As information in this section indicates, too many factors are involved in surviving near-drowning to allow anyone to predict automatically the potential outcome, regardless of situation or setting. In other words, no one can tell absolutely at the scene what will happen with the application of clinically based, aggressive resuscitation practices.

Best resuscitation results apparently follow rapid transport to a medical facility possessing a heart-lung bypass capability. Your plan for dealing with near-drowning should include a procedure for getting the victim to a trauma centre as soon as possible. The heart-lung capability of these centres allows effective and exact rewarming, oxygenation, and medicating as well as immediate analysis of internal chemistry and lung activity.

Do not attempt to rewarm the patient in the field. Do not place the patient directly on a cold surface such as the ground, and avoid exposure to wind. After placing the victim in an SAR unit, lightly cover his or her trunk. Transport the patient horizontally at normal room temperature (i.e. approximately 21°C (70°F)) if possible. Hot packs may be applied to heat loss areas. (This localized application of hot packs is not done to rewarm the patient; rather, as cold blood circulates past the areas where large blood vessels are close to the surface, heat is transferred to the blood. The aim is to moderate the temperature of the blood as it moves toward the heart, not to rewarm the patient.)

Note the following on the patient care form:

- total time submerged;
- water temperature (if possible at the depth containing the patient);
- any changes in body temperature.
- type of water such as contaminated, salt, or brackish or discoloured by organic growth; provide a water sample if possible.

Since you or members of your group may be potential water accident or near-drowning victims, be sure that someone with whom you normally work understands the following:

- the effect of cold, especially on smaller submerged children and even in summer, is profound;
- an individual in such a situation may have the potential for resuscitation while exhibiting no vital signs whatsoever;
- resuscitation efforts should be continued until the patient's body has been rewarmed to near-normal body temperature without corresponding return or improvement of vital signs and doctor's advice; and

- until rewarming takes place, the effects of submersion and/or cold may do the following:
 - reduce heartbeats to less than one every 2 minutes (with a corresponding reduction in breathing), possibly completely obliterating them;
 - completely obscure brachial blood pressure;
 - induce physical rigidity (in some cases) similar to rigor mortis;
 - completely block any eye response.

12.4.5 Apparent signs of death

The following table summarizes apparent signs of death.

Apparent signs of death in cold, living persons

Sign	State	Reason
Cold	Cold to touch	Heat loss to cold water or air
Colour	Unusual skin colour or pallor	Peripheral vasoconstriction
Pulse	Lacking (apparently)	Slow; hard to find in cold person
Pupils	Fixed and unresponsive to light	No response if body below 30°C (85°F)
Rigidity	Induced by cold	Effect of toxic, low- oxygen blood in muscles
Respiration	Lacking (apparently)	Shallow; four times slower than heart

12.4.6 Re-warming procedures

Once again, re-warming is not advisable unless it is impossible to transport the patient to a clinical setting. On the other hand, since there may be some misunderstanding regarding the best re-warming techniques, the following are the basics in this process:

The underlying principle is to remember that cold, acidotic blood contaminated with the harmful by-products of metabolism without oxygen permeates the cooled body's periphery. When a large amount of this blood is allowed to circulate rapidly toward the heart and other organs, it can cause complications as serious as cardiac arrest. This afterdrop phenomenon will occur in any hypothermic patient as circulation increases. The goal is to slow and not aid in its progression.

Most formerly-practiced suggestions for treating the hypothermic patient such as wrapping him or her in warmed blankets or immersing the torso in a warm bath were more harmful than helpful because the overall effect of such procedures was to actually speed afterdrop.

Research has indicated that rewarming from the inside out is less harmful to the patient. A number of methods of warming the interior such as peritoneal lavage (flushing warmed fluids through the abdominal cavity) or mediastinal irrigation have been tried. One simple and apparently efficient all-round method is warm, moist oxygen inhalation. Since the lungs jacket the heart, warming them will in turn warm the heart, thereby protecting it best from afterdrop.

Dry oxygen has a very low specific heat content. Thus, dry gas by itself does little to carry or provide warmth. Conversely, compressed gases expand from their storage tanks at very low temperatures. There is a possibility, especially in the very small chilled victim, that the low temperature of even the dry gas may interfere with rewarming.

12.4.7 Contamination with oil

Do not clean oil off the skin (except around the mouth and eyes) until the person is warm and comfortable. Survivors who have recovered from hypothermia can be taken to a warm shower or bathroom and should have all their clothes taken off. Then, wipe their skin with soft cloth and strong paper towels to remove as much of the oil as possible. Injured or burned areas should be wiped with care or not at all. Next, if a strong warm shower is available, it can be used to remove much of the oil. Hair shampoo will remove oil from the hair and can be used to help remove oil from the body. Then, with time, patience, help, and wiping, and using good body soap to clean the skin, the rest of the oil can be washed away. Solvents, scouring compounds, kerosene, and other cleaners not designed for skin cleaning must not be used. However, it is permissible to use jellied cleansing agents designed for the purpose. But the main cleaning-up is best accomplished by being patient and gentle, by mechanical removal of the oil by wiping and a strong shower, and with hair shampoo and body soap.

12.5 DIVING RELATED INJURIES (SCUBA, ETC.)

A diving accident is normally the responsibility of the local authorities. However, some CCG or CCGA stations and units located in remote areas may also have diving accidents occur in their vicinity. Such accidents might require the closest SAR unit to proceed.

If you are alerted for a diving accident in your area, consider these actions :

- A diving accident requires rapid medical assistance. You may wish to arrange to be accompanied by medical staff if personnel is delayed;
- A decompression chamber is normally necessary. It is RCC/MRSC responsibility to find out where the closest decompression chamber in your area is located. Plan your best evacuation harbour accordingly;
- Bear in mind that a helicopter might be the best means of evacuation;
- Make sure that all detailed information concerning the patient's accident travels with him or her.

12.5.1 Physiology of diving

Pressure is the main problem for diving emergencies. To understand how these injuries can occur, it is important to understand the effects of varying pressure on the human body. Here is a synopsis of the effect of pressure on air-filled body cavities and on inspired gas properties.

The effect of pressure on an air-filled cavity can be easily explained with the example of a balloon. When a balloon is taken to the bottom of a pool, the volume of that balloon decreases during descent. When the balloon is brought back to the surface, its original

volume is restored. This phenomenon is caused by pressure. As the pressure increases during descent, the air inside the balloon gets compressed and the balloon shrinks. When pressure is decreased on the way back up, the air expands (or is decompressed), and the balloon expands.

Now imagine what would happen if someone was to put additional air into the balloon to restore its original volume at the bottom of the pool. Nothing would happen as long as the balloon remains at the bottom of the pool. If the balloon is brought back to the surface, however, it will dilate way past its original size and possibly even burst.

This simple phenomenon explains most diving injuries. All air-filled body cavities can be compared to the balloon. On the way down, the volume of air in these cavities decreases. If the air-filled cavity is rigid (sinuses for example), additional air will be drawn into the cavity, or it will collapse. This phenomenon is called “equilibration.” Failure to equilibrate generally causes severe pains and will discourage any diver from going down. On the way back up, the pressure in the rigid air-filled cavity will increase. If equilibration does not occur again, the pressure may build to the point where the cavity may “explode.” In other word, the air will force its way out of the cavity. For soft cavities (such as the lungs or digestive tract), things are less dramatic. The elasticity of these cavities will prevent immediate damage, but ruptures can still occur if the pressure is diminished too quickly (i.e., the ascent is too fast).

The other important thing about pressure is that it makes gases more dense. The amount of gas that can be dissolved in liquids increases as the gas density increases. Another model will be used to explain this fact. The perfect model is the bottle of champagne. When you observe an unopened bottle of champagne, you do not see any bubbles. This is simply because all the gas is dissolved into the precious liquid. When you remove the cork, air flows out of the bottle, the pressure around the liquid rapidly decreases and bubbles begin to form. At this lower pressure, the liquid cannot hold that much gas, so the excess must leave the liquid. You have probably noticed that bubble formation can be prevented if the cork is removed slowly. Conversely, you can increase bubble formation by rapidly removing the cork.

All this applies to a diver. When a diver goes down, pressure is increased, and an increased amount of gas can be absorbed into the diver’s body (this is the unopened bottle situation). If the diver observes the dive tables and the ascent rates, significant bubbles will not form. If the diver does not observe the tables, bubbles may form. Formation of bubbles in the tissues and the blood stream can cause decompression sickness and gaseous embolism, two life-threatening situations.

12.5.1.1 Decompression

This section on diving physiology could not be complete without a few words on decompression. Divers accumulate gas (mostly nitrogen) in their tissues when they are at depth (because of the increased pressure and gas density). The accumulation of gas is a function of time. The longer a diver spends at a given depth, the more gas he or she will accumulate

in the tissues. Gas accumulation is also a function of depth (or pressure). The deeper you go, the faster the accumulation. At some point, if a diver stays too deep for too long, he or she will not be able to get back to the surface without stopping along the way to allow the excess gas to leave the tissues. These stops are called “decompression stops.” The “no-decompression limit” is the maximum time a diver can spend at a given depth without decompression stops. Information on no-decompression limits and decompression stops is found in diving tables. Failure to perform required decompression and rapid ascent rates are the most common causes of decompression sickness and air emboli.

To minimize risk of injury, prudent divers will conduct the deepest part of their dives at the beginning. They will then ascend slowly and perform decompression (if required) until they surface.

12.5.2 Common diving emergencies

Now let’s look at some common scuba-diving problems. It should be noted that most injuries occur during ascent (when the pressure is decreased).

12.5.2.1 Barotrauma

All air-filled body compartments or cavities have the potential to suffer from the pressure variations that occur in diving. Most barotrauma are not life-threatening, but remember that a diver suffering from a minor barotrauma is likely to suffer from other major problems, since the cause of injury, in both cases, is almost always rapid ascent. The most common problems are:

- ear barotrauma;
- sinus barotrauma;
- tooth barotrauma;
- digestive system barotrauma.

12.5.2.2 Ear barotrauma

Ear barotrauma is probably the most common problem among divers. It may occur during either descent or ascent. During descent, divers must usually perform the so-called Valsalva manoeuvre (pinch their nose and blow) to force air into their middle ears. This manoeuvre counteracts the pressure of water against the tympanic membrane and alleviates the pain associated with the descent. During ascent, the surplus air usually exits the middle ear by itself. If this equilibration mechanism fails, the tympanic membrane may rupture. This will cause sudden and acute pain and will usually make the affected diver extremely dizzy. Loss of balance, disorientation, and inability to stand up are also common symptoms and signs. Victims of ear barotrauma should be transported to a medical centre. The condition, by itself, is not life threatening and quick transport may not be necessary. Be aware, however, that the disorientation may have caused the diver to ascend quickly. Other more serious problems could thus be present.

12.5.2.3 Sinus barotrauma

Sinuses are small cavities inside the bones of the face. Small canals allow air to enter or leave the sinuses. These canals may be blocked by mucus or swelling when a diver gets a cold or is irritated by something (allergic reactions). If this happens, extremely sharp pain will be felt when the diver tries to descend. The pain is so intense that most divers will abort their dive immediately. If, for some reason, the canals get obstructed while the diver is at the bottom, pain will occur during ascent. In some rare cases, the pressure may get high enough to cause the sinus to explode. Fractures of the surrounding bones can occur in this way and air can be injected into the brain. THIS KIND OF BAROTRAUMA IS LIFE-THREATENING! If fractures are present, the victim should be transported quickly to a medical centre.

12.5.2.4 Tooth barotrauma

Sometimes, air may lodge between a tooth and a filling. If this occurs, serious pain may be felt during ascent. Sometimes, the defective filling will even be expelled. Slow ascent may help the diver to manage the pain, but usually, there is not much that can be done. Although very painful, this barotrauma is not serious.

12.5.2.5 Digestive tract barotrauma

The digestive tract can also be affected by pressure. Problems may arise during ascent, when the air content of the gastro-intestinal tract expands. If the expansion is quick enough (rapid ascent), the tract or stomach may rupture. This could allow the entry of air into the blood stream and may cause serious internal damage due to spillage of the content of the tract. Victims of this life-threatening problem should be transported as quickly as possible toward a medical centre.

12.5.3 Air embolism, decompression sickness and bends

12.5.3.1 Air embolism

Air embolism can occur when a diver holds his or her breath during ascent. As the pressure decreases, lung volume increases. At a certain point, lung damage occurs and air is forced into the circulatory system. The air bubbles can then obstruct small blood vessels and deprive certain areas of the body of blood and oxygen. In the coronary arteries, this will cause the equivalent of a heart attack. In the brain, it will cause the equivalent of a stroke. Air embolism is a serious life-threatening condition that requires immediate transport toward a decompression chamber. Signs and symptoms of air embolism are:

- blotching (mottling of the skin);
- froth (often pink or bloody) at the nose and mouth;
- dyspnea (shortness of breath) and cough;
- symptoms of a heart attack;
- symptoms of a stroke;
- dizziness, nausea, vomiting;
- difficulty in speaking;
- blurred vision;
- paralysis;
- decreased level of consciousness or even coma.

12.5.3.2 Decompression sickness (DCS) and bends

Decompression sickness usually occurs when a diver does not observe the dive tables and ascent rates. When this occurs, bubbles can form within the diver's body (the "champagne effect" described above). Depending on their location, the bubbles may cause several problems. In joints, bubbles usually cause pain (known as bends). When bubbles occur within the central nervous system, paralysis can occur. In the circulatory system, the bubbles may block small blood vessels and thus alter blood supply to certain areas. DCS is a life-threatening condition that requires immediate medical attention. The victim should thus be transported quickly to a recompression chamber. Signs and symptoms of DCS have the following characteristics:

- may occur up to several hours after the dive;
- sharp pain is usually felt in joints or abdomen;
- signs and symptoms of air embolism;
- other symptoms such as:
 - altered level of consciousness;
 - paralysis;
 - visual disturbances;
 - difficulty walking;
 - speech disturbances;
 - convulsions;
 - bowel and bladder problems;
 - numbness/dizziness;
 - weakness;
 - extreme fatigue;
 - headache;
 - nausea.

DCS is usually classified as Type I or Type II. Type I refers to skin bends, fatigue or pain involving joints or muscles. Type II includes neurological and cardiorespiratory symptoms.

12.5.4 Guidelines for the treatment of divers

All diving injuries are treated the same way. Here are the priorities:

- Remove the diver from the water;
- Determine the nature of the problem;
- Organize transport to a recompression chamber (if required);
- Support vital functions (CPR if needed) and administer the highest possible percentage of oxygen;
- Place the victim in the appropriate position;
- Perform a secondary survey and treat all other injuries.

12.5.4.1 Remove the diver from the water

Divers may be very bulky and heavy due to the equipment they carry. Getting a diver on board may not be an easy task for anyone who does not know how to remove some of the equipment. Usually, tanks (and everything attached to tanks), harness or buoyancy

compensating devices (BCDs) and weight belt should be removed from the diver before attempting to lift him or her on board. These pieces of equipment may weigh well over 68 kg (150 lbs.) It may also be necessary to remove mask and snorkel (to ease breathing and to allow the diver to see) and fins (to facilitate handling the diver). The procedure for both wet suit and dry suit divers is as follows:

- One of your first priorities is to ensure that the diver will remain afloat while you remove his or her equipment. Inflate the BCD either with the appropriate button (will work only if the diver's tank is not empty) or manually;
- The inflation button is usually located just above the point where the inflator hose connects with the corrugated hose of the BCD;
- To inflate the BCD manually, place your mouth over the mouthpiece, push the adjacent button and blow into the corrugated hose;
- Remove the weight belt and keep it on board. Drop the weight belt only if ABSOLUTELY necessary. If the diver dies, it might be important during the investigation that may result to know how much weight was on the weight belt, since this may be a factor in the accident;
- Now that buoyancy is ensured, you may remove the diver's mask if it is still present. You must also remove the diver's tank and BCD/harness. Some BCDs have buckles on the shoulder that can be unclipped to ease removal. A waist strap is also usually present and must be unbuckled. If the diver is wearing a dry suit, you will have to unplug the dry suit inflator hose before you remove the BCD;
- To unplug the dry suit inflator hose, pull the hose ring away from the valve as illustrated. It might be a good idea to put some air into the dry suit before unplugging the inflator hose;
- Bring the tank on board and shut the tank valve to prevent air losses. It might be necessary to analyze the content of the tank to determine the cause of the accident. Always handle the tank(s) with caution. Severe injury could result if the tank is dropped or the valve is broken;
- Remove diver from the water using standard recovery procedures.

12.5.4.2 Special considerations – recovering technical divers

Technical divers are divers who usually breathe gas mixtures and are engaged in wreck, cave and/or deep diving. It is not uncommon for these divers to carry more than three tanks.

Many technical divers have a crotch strap on their harness that will prevent the weight belt from dropping accidentally. Be aware that it might not be easy to remove the weight belt on this kind of configuration. You may need to cut the crotch strap or unfasten it to remove the weight belt.

Technical divers may have "stage tanks" attached to their harnesses. These tanks must be removed before you attempt to remove the harness/BCD. The stage tanks are usually clipped to D-rings on the diver's harness.

A separate dry suit inflation tank (containing argon gas or air) may be present as well. This tank is usually quite small and may be left in place. You will still have to remove the dry suit inflator hose before you remove the harness.

Canister lamps are also common among technical divers. This lamp can be quite heavy. If well secured, it may be left in place. If not, you may want to remove it to prevent it from dropping on someone's head or foot and causing injury. Many divers will wear this lamp on the (usually right) side of their harness, but it may also be positioned elsewhere.

Many technical divers will wear their backup regulator around their neck. You will have to remove this regulator before you bring the harness and tanks on board.

Most technical dives require the use of double tanks. These can be extremely heavy and are tightly secured to the harness/BCD. The best way to handle double tanks is to hold them by the valves. Never use the connecting bar (if present) to lift the tanks. It is preferable to use two persons to lift this piece of equipment.

On a typical technical harness/BCD system, shoulder straps may or may not have a buckle. If the buckle is not present, do not hesitate to cut the shoulder straps.

12.5.4.3 Undressing an injured or unconscious diver

It may be necessary to undress an injured diver to perform some kind of treatment. There are no simple ways to remove a tight wet suit from an unconscious diver. In fact, removal is not recommended. You may unzip all zippers, but you should leave the rest in place. The risk of cutting the diver while cutting the wet suit is too high.

For dry suit divers, things are simpler. You may easily cut wrist and neck seals. Be very careful when cutting the neck seal. Never use anything but an appropriate pair of scissors (with a blunt end). Once the seals are cut, you may unzip the suit and remove it easily. If absolutely necessary, you may cut the rest of the suit to ease removal. Cutting is acceptable for a dry suit since it is not as tight and close to the skin as a wet suit.

12.5.4.4 Determine the nature of the problem

Try to determine whether the diver is suffering only from a minor barotrauma or from a more serious condition. As a rule of thumb, any symptom felt during the dive must be considered serious. Symptoms that occur after the dive may or may not be serious. When in doubt, always consider the worst and organize transport accordingly. If the diver is unconscious or cannot talk, ask the dive buddy questions (most divers will not dive alone). You may also check the diver's instrument to determine the cause of the accident. Suspect DCS or air embolism for all dives below 18 m (60 ft.) Sometimes, dive computers will show error messages when ascent rate was too fast or when proper decompression has been omitted. All unconscious divers should be treated for air embolism. Anything you find on the dive profile should be included in the patient care form. It is essential to make that information available to other rescuers and to medical personnel. For that matter, ensure that the dive computer/depth gauge follows the casualty to the hospital/recompression chamber.

12.5.4.5 Organize transport to a recompression chamber

If a serious condition is suspected (barotrauma, DCS or air embolism) initiate quick transport toward the closest recompression chamber. Contact the rescue centre to determine whether an aerial evacuation is needed.

Support vital functions (CPR if needed) and administer the highest possible percentage of oxygen

Administer the highest achievable percentage of oxygen. Be prepared to perform CPR if needed. If you need to perform CPR on a diver wearing a dry suit, cut the neck seal to facilitate blood flow to the brain. Undressing a diver needing CPR may be time consuming and impractical. Undressing the diver is not recommended if he or she has not been undressed before the CPR needs to be started. Dry suit valves may hinder hand placement during chest compression. Remove or cut the dry suit if necessary.

12.5.4.6 Place the victim in the appropriate position

Conscious or unconscious divers who are breathing by themselves should be placed in the lateral recumbent position. Unconscious divers requiring CPR should be strapped flat on a spine board. If a perfectly horizontal position cannot be maintained, position the casualty so the head will be slightly lower than the rest of the body (usually feet toward bow and head toward stern). This is of paramount importance, as it prevents air bubbles from accumulating in the brain.

12.5.4.7 Perform a secondary survey and treat all other injuries

A secondary survey should be performed if possible. The diver's suit may complicate the examination. Obvious injuries should be treated on a priority basis.

12.6 MULTI-CASUALTY SITUATIONS

Generally, any more than one or two casualties at one time will over-tax the abilities and equipment of the rescue unit. These situations require the coordinated effort of multiple resources. Rescuers should be aware of the response management system and prepared to set it into motion. They should alert RCC/MRSC as soon as it becomes obvious that they are dealing with a multi-casualty situation.

12.6.1 Triage

The dictionary definition of triage is: "The sorting and allocation of treatment to patients, and especially battle and disaster victims, according to a system of priorities designed to maximize the number of survivors."

Because patient condition can change, triage must be a continuous process, maintained throughout the course of the rescue.

12.6.1.1 General rules of triage

- Injuries threatening life take priority over injuries threatening limbs;
- Injuries threatening function (e.g., the respiratory system or cardiovascular system) take precedence over injuries causing anatomical defect (e.g., fractured femur or skull fracture in a conscious patient);
- Airways in unconscious patients can become obstructed at any time. Noisy respiration means partial obstruction of the airways;
- Patients in shock or with reduced blood volume tolerate transportation poorly;
- Urgent treatment must never be delayed by documentation needs;
- A patient's condition may warrant change from a delayed category at any time; hence, delayed-category patients must be reassessed periodically.

Note: Rescuers on small craft are more likely to be acting as first aid providers rather than triage officers. However, they should be familiar with the triage tagging system in order to be able to provide first aid care where it will be most effective.

It is essential that the triage officer develop an idea of the overall seriousness of the medical situation. This is best done by reviewing the history of the event, e.g., speed of impact, severity of the fire, the length of water immersion and so on. If the casualties are relatively close together, the triage officer should rapidly move into the area and try to estimate the number of casualties involved. This preliminary assessment should be passed on to the on-scene commander as early as possible.

If the casualties are widespread, it may be necessary to assign more than one triage officer. Ensure, however, that patients are tagged only once. After initial triage is complete, the triage officers must communicate with each other and summarize the situation in a report to the OCS/CCS.

The triage officer moves quickly from patient to patient, spending no more than 30 seconds at each. During this time, the triage officer shall:

- tie a triage tag to the right arm or right leg of the patient;
- categorize the patient into one of the four categories (green, yellow, red or black).

12.6.2 Casualty evaluation

The assessment of casualties in a triage context is done with a crude and simplified primary assessment. Many triage methods exist. The S.T.A.R.T. method (Simple Triage and Rapid Treatment) is currently the more widely recognized.

When doing triage, always remember that if a victim can speak to you, airways are clear, breathing and circulation are adequate. These victims are thus to be classified into the green or yellow category. An even better trick to rapidly classify many victims is to send everybody that is able to walk to a designed area. Those present at the designed area can be categorized as green, while the other talking casualties that were not able to move will usually be classified as yellow. Remember, however, that the status of any green casualty may, under some circumstances, deteriorate toward more urgent categories. You may need to reassess those casualties periodically.

12.6.3 Priorities for treatment and evacuation

Triage and disaster management are multi-service problems. To ensure that all agencies involved follow a standard system of setting priorities for patient care and transportation, a common system of assigning priority has been established. The four categories are:

- urgent (red);
- delayed (yellow);
- minor (green);
- deceased (black).

When the disaster scene is stable, the priorities for evacuation are the following:

- red;
- yellow;
- green;
- black.

When the scene is unstable, reverse the priorities in order to maximize chances of saving as many people as possible. In these cases, use the following priorities for evacuation:

- green;
- yellow;
- red;
- black.

12.6.3.1 Urgent category (red)

This category comprises patients whose lives or limbs are in immediate and serious jeopardy and for whom urgent treatment and evacuation are required.

12.6.3.2 Delayed category (yellow)

This category comprises mainly patients whose lives are not in serious jeopardy, although a limb or organ may have sustained a crippling injury. The physical status of these patients is, for the moment at least, relatively stable. Evacuation takes place as transportation becomes available.

12.6.3.3 Minor category (green)

These patients may not require hospitalization. They may be cared for at the treatment area or in local doctors' offices.

12.6.3.4 Deceased category (black)

Bodies should be tagged last. If bodies are dismembered, tag the head. Body parts other than the head should not be tagged but marked by some other method. This category also includes victims with little hope of survival under the best of circumstances or medical care such as unconscious victims with no spontaneous breathing and pulse. Taking care of such patients would immobilize rescuers who would be more useful and efficient helping people with better chances of survival.

12.6.4 The tagging system

Part of the interagency standardized response to disaster is a common tagging system. This is essential, as patients will probably be handed from one agency to another during the evacuation phase, and each agency must be able to “read” the tagging system in use.

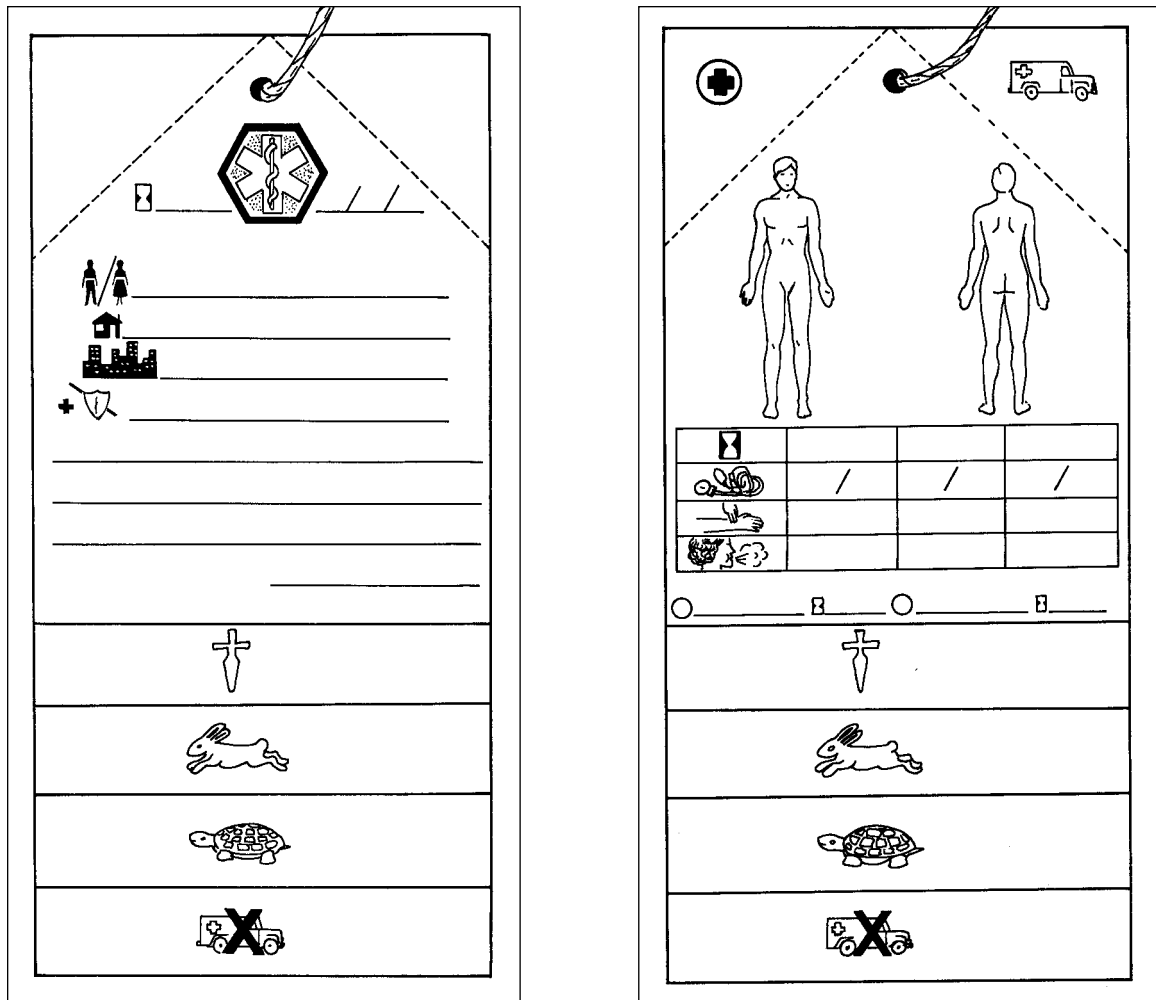

Figure 12.3: Triage tag

THE COLOUR TAGGING SYSTEM MUST BE THE ONLY ONE USED.

If for some reason no triage tags are available, the person conducting triage should describe the patients in the same manner, i.e., urgent (red), delayed (yellow), and minor (green). Obviously, a good supply of triage tags must be readily available on each SAR unit. If triage tags are not available, coloured tape can be used.

If the number of casualties is overwhelming or the extrication of victims from wreckage precludes immediate tagging with triage tags, coloured survey tape may be used to initially indicate priorities for care, providing that the colours used conform to the triage system.

Patients are to be tagged with triage tags at the first reasonable opportunity, which will probably occur when the patient reaches the casualty collection area.

12.6.4.1 The tagging of casualties

When each casualty is being triaged, a triage tag shall be filled out. Where there is a sufficient number of rescuers, a person should accompany the triage officer and carry out the tagging function.

It is imperative that each casualty in need of hospitalization who is placed in the urgent or delayed category receive a tag that indicates priority of treatment/evacuation. This tag should be attached firmly and visibly, in order of preference:

- to the right wrist or right arm;
- to the right ankle; or
- around the neck (loosely).

The following essential information shall be legibly entered on the tag:

- time of triage, including the date if the duration of the disaster is expected to exceed 24 hours;
- name of triage officer; and
- injuries noted on the reverse side.

The most appropriate way to describe a patient in a disaster setting is as follows:

- level of consciousness:
 - A = alert;
 - V = responds to voice;
 - P = respond to pain;
 - U = unresponsive to pain.
- pulse rate;
- condition of chest/abdomen: indicate injury or absence of injury;
- use a crosshatch for burns;
- use an "X" for major lacerations;
- use a "#" for fractures or dislocations;
- indicate if a tourniquet was used and the time it was applied, and put a "T" on the patient's forehead.

Note: The triage officer should fill in as much of the above-mentioned information as he or she can. The rest is to be filled in by the next rescuers coming to help the victim. The primary role of the triage officer is to quickly categorize all casualties. Extensive casualty assessment should be done once the preliminary triage is done.

There is other information which, though not essential, is important and should be filled in by other workers while the patient is waiting for transport (or during transport):

- name;
- home address and phone number; and
- allergies and medications the patient is taking.

12.6.4.2 Triage tags

When tagging a patient, tear off all the tags below the one that describes the patient. Keep the tabs that have been removed, as they can be used later to determine the number of patients and the assigned priority of each. All the tabs are printed with the patient number. If you have tagged bodies (the bottom tab is not torn off), tear off the corner of the tag (which also has the tag number).

If a patient has initially been assessed at one level and his or her status changes such that he or she must be moved to a higher level of priority, simply tear off the tabs below the one you want.

If a patient is reassessed and can be placed in a less urgent category, re-tag the patient. Keep the old tag and note on it the new tag number along with the fact that the patient has been re-tagged.

12.6.5 Multi-casualty first aid

The cardinal rules of first aid undergo some changes when many badly injured patients require triage and treatment. The ABCs of first aid still apply, but some variation may be necessary to accommodate the best interests of the majority of the patients.

12.6.5.1 Airways

Unconscious patients must be placed in the recovery position to assist drainage and maintain a patent airway. Do this with consideration for potential cervical injury, and although you have been taught never to leave an unconscious patient, this will probably be necessary to enable you to deal with the other patients.

12.6.5.2 Breathing

In a multi-casualty situation where a number of patients are seriously injured and need immediate care, you must judge whether rescue breathing is appropriate. Remember that this procedure requires the undivided attention of a trained person who might otherwise be better utilized in providing care to other patients.

The presence of devastating head or chest injuries resulting in respiratory arrest may be an indicator of an unsalvageable patient.

If the patient is breathing but in respiratory distress after trauma to the chest, consider a pneumothorax. Pneumothorax patients can be easily saved if the proper medical procedure can be applied in time.

12.6.5.3 Circulation

As with respiratory arrest, the absence of a pulse in the unconscious non-breathing patient presents a need to decide whether resuscitation is appropriate in the face of other patients urgently needing care. If the cardiac arrest is the result of trauma to the head, chest, or if severe, devastating internal or external hemorrhage has occurred, resuscitation is unlikely

to be successful. CPR in triage situations is not recommended unless an incredibly large team of rescuers is present.

Remember that if patient is breathing, his or her heart is beating and there is circulation even if the pulse is not detectable. This could certainly be the case in severe hypothermia or shock.

12.6.5.4 Deadly bleeding

Almost all severe, external bleeding can be either slowed or stopped by continuously applied direct pressure. If the hemorrhage is from a limb, and cannot be controlled by direct pressure, or you are unable to stay with the patient or get the patient to apply pressure himself, a tourniquet is appropriate to save life. Remember, though, that a tourniquet is to be used only when direct pressure cannot be continuously applied and the life of the patient is obviously at stake. Do not loosen or remove a tourniquet once it is applied.

Be sure to indicate on the triage tag that the tourniquet is applied, and write the letter “T” on the patient’s forehead.

12.6.5.5 Hypothermia

Always consider hypothermia to be a potential factor in disaster management. Even when the patients have remained dry, heat loss will occur if the injuries preclude the production of heat through physical activity. Remember also that, if clothing is removed to treat injuries, insulation will need to be replaced.

12.6.5.6 Shock

Hemorrhage or hypovolemic shock is often the cause of death in trauma. This condition is treacherous because the body will compensate for blood loss by shunting blood to critical organs. Even though there is continued hemorrhage, the patient may exhibit no signs of severe shock, particularly if they remain at rest and lying down.

If hemorrhage is not stopped, a point will be reached where the body can no longer compensate for the continued blood loss and signs of severe shock will appear. This is considered an extremely serious situation with a poor prognosis.

The best field management of progressive hypovolemic shock is to prevent it in the first place by stopping external bleeding, and by recognizing the potential for severe internal bleeding and arranging early evacuation for patients suspected of severe internal (invisible) bleeding.

The three areas where critical amounts of blood can be lost internally are the chest, abdomen and thighs. Remember that patients with hemothorax will exhibit signs of hypovolemic shock before they are short of breath. A history of blunt abdominal trauma is all you will have initially to lead you to suspected hidden hemorrhage. Do not rely on abdominal muscle guarding as the sole indicator of intra-abdominal hemorrhage. Massive blood loss into the thighs may accompany femur fractures, and you can monitor blood loss by noting the circumferences of the thigh.

12.6.5.7 Long bone fractures

One of the most time-consuming activities in first aid is the splinting of fractures or dislocations of the arms and legs. The supply of splinting material may also be exhausted quickly, forcing the use of alternative procedures. Remember the principles of splinting – immobilize the joints above and below the break. In most cases, adequate immobilization of the upper limb can be achieved quickly by securing the injured limb (with proper padding) to the torso. A fractured leg can be immobilized by tying it to the opposite leg. Almost any fabric that you can tear into strips will substitute for triangular bandages.

12.6.5.8 Burns

Remember that the first action for thermal burns in first aid is to quickly cool the burned area to normal temperature. You may encounter patients who have jumped into the water to put out the fire. In these cases, the burns will be adequately cooled, but you must now watch for signs of hypothermia.

Do not attempt to remove clothing that adheres to the wound. Cover the patient with clean, lint-free sheets. Soot and blisters in the airways, burned nose hairs and dyspnea (shortage of breath) indicate the presence of respiratory tract burns. These are very dire signs, and these patients are not easily salvageable.

12.7 SPINAL INJURIES**12.7.1 Cervical spine**

A cervical spine injury usually is incurred as a result of diving into shallow water, although other situations also can cause this injury (e.g., high-speed boat collisions, falling head first from a height). A fractured skull might also be involved; however, skull fractures usually result from collisions rather than water-related falls or diving. Apparently water tends to protect the head by providing a partial cushioning effect.

Conversely, when a diver's head hits an unprepared bottom layer of sand or silt, the head is generally held in place. This inability to move laterally tends to concentrate downward momentum or force, and the rest of the body massively presses on the upper part of the spinal column, frequently resulting in damage (usually compression fractures) to the fourth, fifth, or sixth cervical vertebrae.

If the bottom is smooth and slick, such as that of a slippery swimming pool, the diver's head may slide a short distance after impact. The result of this cranial displacement is either hyperflexion or hypertension, with the head bent violently forward or backward as it supports the body's plunging weight. This may also result in fracturing, displacement or disruption of the vertebrae.

In many of these instances, the victim is paralyzed on impact and unable to do anything to gain attention or, more importantly, unable to roll over on his or her back and float face up. If the victim is allowed to remain face down, he or she will drown. On the other hand, if the victim is not rolled over correctly and supported properly, the initial damage to the spine may be worsened.

You must assume the possibility of cervical injury when unconsciousness is caused by trauma to the head. Exercise spinal-injury precautions in all cases where spinal injury cannot be ruled out. Remember the principle of spinal-injury management. First, take care of the ABCs: keep the patient still and ensure that the body is kept in alignment. Any flat surface that will support the patient can be used as a backboard. Ensure that adequate padding is used, and that the patient is adequately secured.

12.7.2 Spinal immobilization techniques

The following immobilization techniques use equipment that requires advanced training. Untrained personnel should not attempt to use these devices on their own. However, they should be familiar with their use in order to assist more advanced first aid personnel to apply them.

12.7.2.1 Using rigid cervical collars

Cervical collars are used to prevent head and neck movement when cervical spine injury is suspected. In cervical spinal injury, movement of the neck may result in paralysis of the respiratory muscles, so extra care must be exercised. Always refer to the manufacturer's instructions for specific information on a particular brand or model.

Sizing is crucial. A collar that is too small will not prevent excessive head movement while a collar that is too large will not place the head in a neutral position. Always measure the collar carefully.

Collar preparation: Assemble the collar by following manufacturer's specifications.

Placing the collar: Have a helper stabilize the head while you place the collar. Begin by fitting the chin piece. Then, bring the back piece around the back of the head and attach the Velcro band.

12.7.2.2 Using spinal immobilization devices

There are different kinds of spinal immobilization devices. Some are more suited for confined space or extrication use, while others are larger and more suited for open area usage. Despite the differences between the various models, all spinal immobilization devices are used in a similar manner.

12.7.2.3 Spine boards

Prepare the casualty for handling by first putting on a cervical collar (if available). Then, use triangular bandages to tie the feet and hands together. One person should be assigned to hold the head during the whole process.

Roll the casualty on one side and prepare the spine board. At least three rescuers are needed for this manoeuvre. One rescuer continuously holds the head, another is responsible for actually rolling the casualty, and another is needed to handle the spine board. It is essential for the rescuers handling the casualty to be perfectly synchronized. The rescuer assigned to hold the head should lead all spinal immobilization.

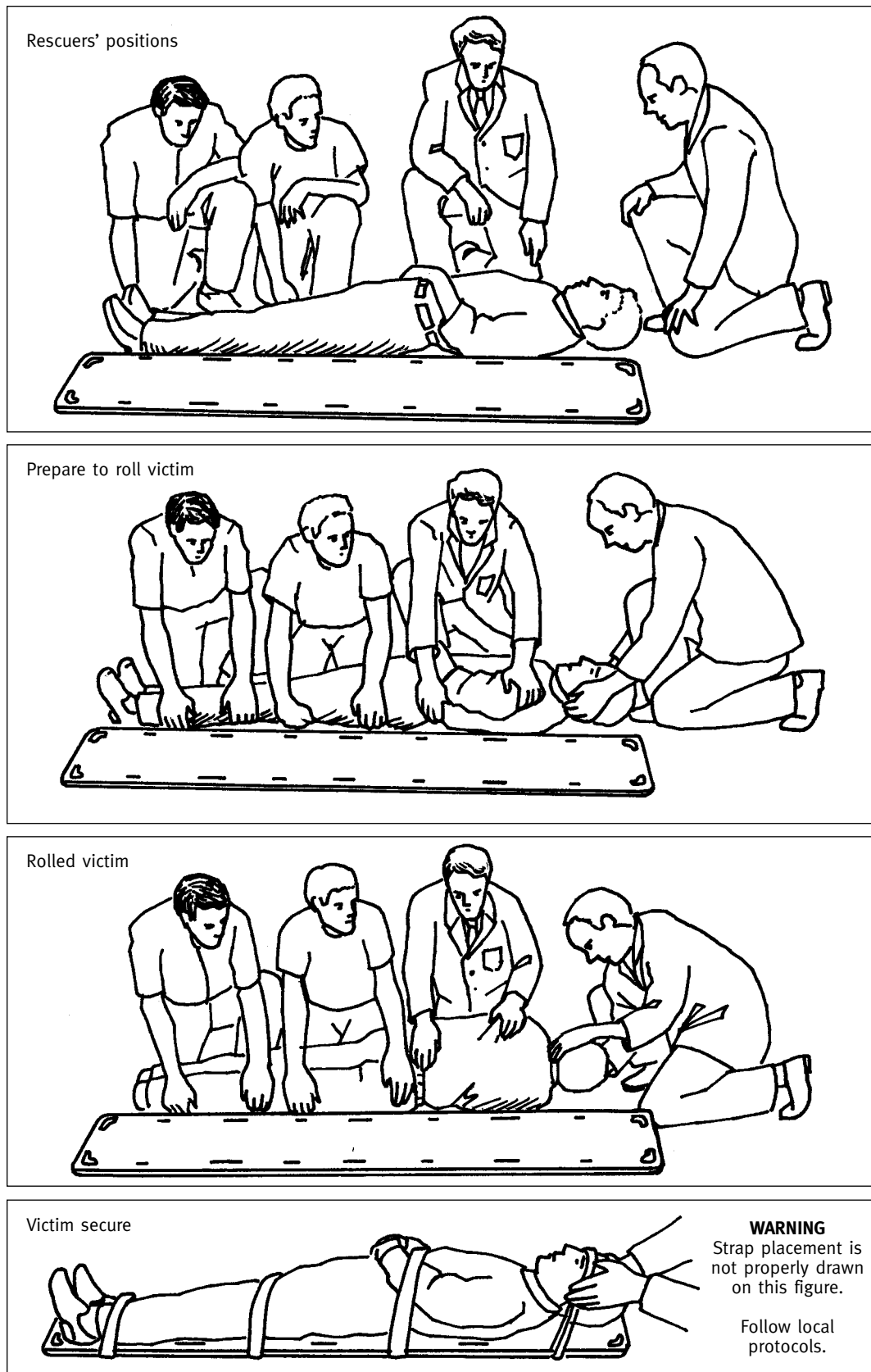

Figure 12.4: Rollover technique using spine board

Lower the casualty onto the spine board in a synchronized manner. The casualty will probably not be centred on the board at this point. Note that if the casualty's skin is exposed (e.g., casualty in a swimming suit), it might be a good idea to put a blanket on the spine board, as it will ease the rest of the process. Bare skin on any surface does not slide as well as clothing. The blanket will also prevent heat loss and preserve the dignity of the victim.

Centre the casualty on the spine board by gently pushing on the casualty's side. If you placed a blanket on the board, you may pull the blanket to perform this operation. Again, synchronicity is important for this step.

Secure the torso and pelvic region of the casualty's body first.

Secure the head of the casualty with an appropriate head immobilization device. If such head immobilization devices are not available, use a blanket folded around the head of the casualty. Once the head is adequately immobilized, the rescuer assigned to the head may be relieved.

Secure the rest of the victim's body.

12.7.2.4 Kendrick Extrication Device (KED)

The KED is a very useful device for performing a spinal immobilization in closed quarter situations or on a seated casualty. The following describes the use of the KED:

- Have someone hold the head during the whole process. Put a cervical collar on the casualty;
- Gently push the casualty forward and maintain head alignment. Slide the KED into position;
- Position side straps and centre the KED on the casualty's back before securing the straps. Lift the KED so that the side wings are almost resting below the armpits of the casualty;
- Secure torso straps. Ask the casualty to take a deep breath and tighten the straps. This will ensure optimum tightness without compromising breathing;
- Ensure that the groin loops are well positioned and secure them;
- Fold the head cushion to the right side, slide it behind the casualty's head and secure the head with the Velcro straps. Once the head is secured, the rescuer assigned to hold the head may be relieved;
- Move the casualty to a spine board;
- Unbuckle the groin loops before stretching out the legs;
- Complete the spine board immobilization as usual.

12.7.2.5 Miller board or litter

The Miller litter can be used much like a spine board. The initial steps of casualty preparation and rolling are similar. The Miller board has straps already attached and is very useful for rapid extrication.

The Miller Half Back is a spinal immobilization device similar to the Kendrick Extrication Device. It allows casualties with suspected cervical spine injuries to be immobilized in confined spaces. The device is rated for lifting so that casualties can be lifted (or lowered) through small openings such as escape hatches without having to be secured in a basket stretcher.

12.7.3 In-water spinal injuries

It is not always a good idea to attempt an in-water spinal immobilization. In-water spinal immobilization requires a fair amount of time. It thus exposes the casualty to waves and cold water for an increased period. Waves will cause movements of the casualty's back and can thus aggravate the spinal lesion. Under such conditions, it might be preferable to quickly remove the person from the water and then perform a full spinal immobilization.

Maintaining breathing, if present, is the absolute priority.

Although spinal injuries can cause life-long disabilities, breathing should remain the top priority. Rescuers must remember that breathing is compromised for as long as the casualty remains in the water, and this is especially true in rough sea conditions. Yet, breathing can also be compromised if a cervical spinal injury is handled roughly, since cervical spine fractures can lead to paralysis of respiratory muscles.

If spontaneous breathing is not present, start artificial ventilation as quickly as possible. In-water artificial ventilation is not recommended, as the risks far outweigh the benefits. Performing adequate in-water artificial ventilation is extremely difficult. Water may be pushed into the lungs, inappropriate volumes of air may be given (this may cause gastric distension and cause the casualty to vomit), and it will be very difficult to prevent aspiration of fluids or gastric content into the airways if the casualty vomits. The best course of action for this situation would be to quickly remove the person from the water. After removal, the casualty should be placed directly on a spine board while someone is performing artificial ventilation.

Rescuers must thus evaluate a risk-to-benefit ratio to determine the best course of action between rough handling/quick removal or gentle handling/slow removal. To determine this risk-to-benefit ratio, take the other two guidelines into account.

Some water removal techniques are better than others. Rescue frames, for example, are an excellent compromise, since their rigidity prevents some movement. If the situation permits, a cervical collar can be put on in the water. This will help to keep the head alignment during the retrieval. A spine board can be placed on the side of your unit so that the casualty is rolled right onto it. This trick may not work on all units. Alternatively, the spine board can be placed on the deck. The casualty will have to be lowered manually from the side of the vessel to the spine board.

Another good compromise is the use of a Miller litter combined with the parbuckling technique. However, this is more time-consuming than the rescue frame technique.

Time in the water is an important fact.

As mentioned above, exposure to cold water is a factor to be considered. Since spinal injuries are in themselves serious, rescuers should try to avoid other complications. Hypothermia is always a risk in the cold water of Canada, and the best way to prevent its occurrence is to quickly remove the person from the water.

12.8 CARE OF RESCUE CRAFT SURVIVORS

12.8.1 Survival at sea

Under ideal conditions the healthy uninjured person may be able to survive three days at sea in a lifeboat or raft. However, survival for more than a month is not uncommon.

The actions and emotional stability of the castaways depend first upon the morale and psychological strength of both the group and the individual. A group of experienced seamen, for instance, will be psychologically stronger than a group of shocked passengers. Psychological problems may appear at any time before or after the rescue.

12.8.2 Medical problems encountered with survivors

12.8.2.1 Seasickness

Seasickness (motion sickness) is an acute illness characterized by loss of appetite, nausea, dizziness and vomiting.

12.8.2.2 Sunburn

Sunburn is one of the principal medical hazards of survival on the open sea, regardless of latitude. It may vary from a first- to a third-degree burn, depending upon the exposure and the protection available to the victim. Initially, sunburn is generally characterized by redness, edema, and tenderness of the skin. It may be accompanied by local pain, fever, nausea, vomiting, diarrhea or weakness.

12.8.2.3 Dehydration and malnutrition

Survivors who have been adrift for several days may be suffering from dehydration. If they have been adrift for several weeks, malnutrition may also be a problem. Caution should be exercised in trying to reverse either dehydration or malnutrition rapidly. Initially, a diet of nourishing liquids (sugar and water or milk or soup) will satisfy nutritional requirements (before using sugar, always ensure that the casualty is not diabetic). **Medical advice** should be sought (either via MCTS, RCC/MRSC or directly by using a cellular phone). This diet should continue until the survivor can be transferred to care ashore.

12.8.2.4 Heat exhaustion

Heat exhaustion is caused by loss of body water and salt.

12.8.2.5 Heat cramps

Heat cramps are painful spasms of the muscles of the extremities, back, or abdomen due to salt depletion. The skin is usually moist and cool, and muscle twitching is frequent.

12.8.2.6 Cold exposure injuries (local)

Cold injuries to parts of the body (face, extremities) are caused by exposure of tissues and small surface blood vessels to abnormally low temperatures. The extent of the injury depends upon such factors as temperature, duration of exposure, wind velocity, humidity, lack of protective clothing, or presence of wet clothing. Also, the harmful effects of exposure to cold are intensified by fatigue, individual susceptibility, existing injuries, emotional stress, smoking, and drinking alcohol.

Cold injuries to parts of the body fall into three main categories: chilblains, immersion foot, and frostbite.

12.8.2.7 Chilblains

This relatively mild form of cold injury occurs in moderately cold climates with high humidity and temperatures above freezing (0-16°C / 32-60°F). Chilblains usually affect ears, fingers, and the back of the hand, but they may affect the lower extremities, especially the anterior tibial surface of the legs.

They are characterized by the skin turning a bluish red and by mild swelling often associated with an itching, burning sensation, which may be aggravated by warmth. If exposure is brief, these symptoms may disappear completely with no remaining signs. However, intermittent exposure results in the development of chronic manifestations such as increased swelling, further discoloration of the skin (which becomes a deep reddish purple) blisters, and bleeding ulcers which heal slowly and leave numerous pigmented scars.

Treatment. For skin discomfort, apply a bland soothing ointment such as petrolatum. People susceptible to chilblains should avoid the cold or wear woolen socks and gloves.

12.8.2.8 Immersion foot

This form of cold injury is caused by exposure of the lower extremities to water at above-freezing temperatures, usually below 10°C (50°F), for more than 12 hours. It characteristically occurs among shipwrecked sailors waiting on lifeboats or rafts in enforced inactivity, with a poor diet, wet and constricting clothing, and adverse weather conditions. Clinical manifestations include swelling of the feet and lower portions of the legs, numbness, tingling, itching, pain, cramps, and skin discoloration.

In cases of immersion foot uncomplicated by trauma, there is usually no tissue destruction.

Treatment. After rescue, every effort should be made to avoid rapid rewarming of the affected limbs. Care should be taken to avoid damaging the skin or breaking blisters. Do not massage affected limbs.

Prevention. Every effort should be made by survivors to keep their feet warm and dry. Shoelaces should be loosened; the feet should be raised and toe and ankle exercises encouraged several times a day. When possible, shoes should be removed, and unwanted spare clothing wrapped around the feet to keep them warm. Smoking should be discouraged.

12.8.2.9 Frostbite

This is the term applied to cold injuries where there is destruction of tissue by freezing. It is the most serious form of localized cold injury. Although the area of frozen tissue is usually small, frostbite may cover a considerable area. The fingers, toes, cheeks, ears and nose are the most commonly affected parts of the body. If exposure is prolonged, the freezing may extend up the arms and legs. Ice crystals in the skin and other tissues cause the area to appear white or green-yellow in colour. Pain may occur early and subside. Often, the affected part will feel only very cold and numb, and there may be a tingling, stinging, or aching sensation. The patient may not be aware of frostbite until someone mentions it. When the damage is superficial, the surface will feel hard and the underlying tissue soft when depressed gently and firmly. In a deep, unthawed frostbite, the area will feel hard and solid and cannot be depressed. It will be cold and numb, and blisters will appear on the surface and in the underlying tissues in 12–36 hours. The area will become red and swollen when it thaws, gangrene will occur later, and there will be a loss of tissue (necrosis). Time alone will reveal the kind of frostbite that has been present. It is fortunate, therefore, that the treatment for various degrees of frostbite is identical. The exception is superficial frostbite. **A frostbite of the superficial, dry, freezing type should be thawed immediately to prevent a deep-freezing injury of the part involved. However, never thaw a frozen extremity before arriving at a facility with water, heat and equipment where the extremity can be rewarmed rapidly.**

Treatment. All freezing injuries follow the same sequence in treatment: first aid, rapid rewarming and care after first aid.

First aid. The principles of first aid in localized cold injury are relatively few. The two most important things are to get the patient to a place of permanent treatment as soon as possible and then to rewarm him or her. It is important to note that a patient can walk for great distances on frostbitten feet with little danger. Once rewarming has started, it must be maintained. All patients with local cold injuries to the lower extremities become litter cases. Refreezing or walking on a partially thawed part can be very harmful. During transportation and initial treatment, the use of alcoholic drinks should not be permitted, because they affect capillary circulation and cause a loss of body heat. Ointments or creams should not be applied.

Rapid rewarming. The technique of rewarming has two phases: (1) treatment of exposure; and (2) treatment of the local cold injury. Treatment of exposure consists of actively rewarming the patient. This is done in principle by the removal of cold and the addition of warmth. Removal of cold is accomplished by removal of all cold and wet clothing and constricting items such as shoes and socks. Addition of warmth is provided from external and internal sources. External warmth is added by providing the patient with prewarmed clothes and blankets. Giving a patient a cold change of clothes, a cold blanket, or a cold sleeping bag will cause a rapid dissipation of his or her residual heat. If necessary, it would be better to have someone give the clothing he or she is wearing to the patient. Warm the patient's sleeping bag before he or she gets into it. A good source of warmth is the body heat of other people. In general, hot liquids and an adequate diet provide internal warmth.

12.9 EXTERNAL ASSISTANCE

12.9.1 Medical advice

Procedures and techniques above and beyond the rescuer's ability should not be attempted.

However, first aiders should be aware that there is medical advice available to them at any time.

Medical advice is available by direct radio-telephone contact with a doctor, from a number of ports in all parts of the world or from RCC/MRSC (you can ask them to put you in touch with a doctor). It may, on occasion, be obtained from another ship in the vicinity that has a doctor on board. In either instance, it is better if the exchange of information is in a language common to both parties. Coded messages are a frequent source of misunderstanding and should be avoided as much as possible.

It is very important that all the information possible should be passed on to the doctor and that all his or her advice and instructions should be clearly understood and fully recorded. A comprehensive set of notes should be ready to be passed on to the doctor, such as the routine particulars about the ship, routine particulars about the patient, history of the injuries, results of examination, first aid treatment, problems and other relevant comments. Have a pencil and paper available to make notes, and remember to transcribe these notes to the patient's and ship's records after receiving them. It is a good idea to record the exchange of information by means of a tape-recorder, if one is available. The recording may then be played back to clarify written notes.

It may be necessary, under certain circumstances, to withhold the name of the patient when obtaining medical advice, in order to preserve confidentiality. In such cases, the patient's name may be submitted later in writing to complete the doctor's records.

12.9.2 Signs of death

12.9.2.1 Only a doctor can declare a patient dead.

Great distances, long travel times to medical facilities and shortage of personnel may make basic life support difficult or impossible to maintain. Under these circumstances, permission may be obtained from a medical doctor to withhold or cease basic life support. The following are some signs that, if present, will help the doctor make the decision to declare the casualty dead.

- The heart has stopped. No pulse will be felt and no heart sounds will be heard. Put your ear on the left side of the chest near the nipple and listen carefully. If you are not sure what to listen for, listen to the left side of the chest of a live person first. To determine whether circulation has stopped, tie a piece of string tightly round a finger. In life the finger becomes bluish, but in death it remains white. Slight pressure on the fingernail or lip in life will cause the area to become pale, and when the pressure is released the colour is regained. In death, this will not occur. BE CAREFUL, SINCE HYPOTHERMIA MAY MIMIC THESE SIGNS!

- Breathing has stopped. Listen with your ear right over the nose and mouth. You should feel no air coming out and should see no chest and abdominal movement. A mirror held in front of the nose and mouth will be clouded by the moisture in the outgoing breath in life, but no clouding will occur in death.
- The person looks dead. The eyes become dull and the skin pale. The pupils are large. Shinning a bright light into the eye does not make the pupil smaller.

These are the immediate signs of death. Later signs are as follows.

- Rigor mortis. This is a stiffness of the body that usually comes on about 3-4 hours after death. The timing will depend to some extent on the ambient temperature. The stiffness lasts for 2-3 days. It is most easily felt in places like the jaw, the elbow, and the knee;
- Post-mortem lividity or staining. Blood in a dead body will tend to gravitate. If the body was left lying on its back after death, there will be reddish or purplish patches resembling bruises over the back and over the back of the limbs that were downwards. This is called post-mortem lividity or staining. It is possible to deduce from this staining the position the body was in after death;
- The cornea goes milky. The cornea is the clear window at the front of the eye. It goes milky about 15 hours after death;
- Decomposition. Changes due to decomposition can be seen 2-3 days after death, and will usually appear first in the abdomen, where a greenish colour may be observed. This is a certain sign of death.

If there is uncertainty about the possibility of life, always try artificial respiration and heart compression.

12.9.3 Use of a camera

If the circumstances of death are other than straightforward, or if there is any suspicion of criminal intent, photograph the body where it was found and from several angles. When the body is moved, take more pictures of the scene to show any blood or other evidence. Try to record all observations you think may be of help in identification or of interest with regard to the cause of death. Advise police.

12.10 TRANSPORTATION OF CASUALTY IN FAST RESCUE CRAFT

12.10.1 Limitations of Fast Rescue Craft

The high speed of FRCs makes them a good choice for transporting first aid patients when time is the prime consideration, but it should be kept in mind that FRCs have:

- no shelter from the elements;
- limited space for first aid equipment;
- limited deck space for stretchers/spine board and for first aiders to work;
- violent acceleration/deceleration forces that may aggravate injuries, accelerate onset of shock and make some medical procedures (e.g., CPR) difficult or impossible to perform.

Carriage of first aid equipment

Since the FRCs used in DFO/CG operations vary widely in their size, speed and normal utilization, there will be a major difference in the first aid equipment normally carried. Dedicated IRBs, SAR station FRCs, etc. will carry more gear than an FRC engaged in beacon work or scientific survey, for example.

There should, however, be a minimal kit carried in all FRCs at all times. Such a kit should include latex gloves, pocket masks, field dressings, space blankets and chemical heat packs. Other equipment may be included as space allows.

Bulkier items such as O₂ kit, stretchers etc. can be put on board as needed on a case-by-case basis.

12.10.2 Methods of immobilization in FRC

Once again, the high speed and violent motion of an FRC should be a consideration when choosing methods of immobilization of injuries. Where it may be acceptable to leave a patient on a scoop stretcher for some time on a large vessel, it would be extremely uncomfortable for a patient to be strapped to one for even a short time during transport in an FRC in rough sea conditions. A padded basket stretcher might be a better alternative.

Even minor fractures need to be secured thoroughly during transport in an FRC. Lower limb fractures especially need to be tightly splinted (blanket splint would not be adequate on its own), as movement may cause severe shock due to blood loss. However, keep in mind that an urgent transport may take precedence over securing minor fractures.

Full spinal immobilization should be particularly well-padded, possibly including extra padding between the spine board and the basket stretcher to act as a shock absorber. Great care should be taken in securing the stretcher into the FRC to prevent unchecked movement within the craft.

Patients who are immobilized for transport will be very susceptible to cold, which could worsen shock. Even in warm weather, high wind speed and the patients' inability to move could cause lowering of body temperatures. Every effort should be made to provide shelter. Space blankets and heat packs will help reduce heat loss.

12.10.3 Artificial Respiration (AR) and CPR in FRC

The limited space and small crew size in an FRC may preclude two people performing CPR. Although not recommended, it may be necessary for only one rescuer to perform CPR. This is something that should be practiced regularly so that rescuers are familiar with the limitations within their vessel.

If AR is required, especially on a hypothermic patient, the preferred method is mouth to mask (with supplemental oxygen if available). This provides warmth and moisture to the patient and is frankly much easier to perform than the Bag/Valve/Mask method, which is difficult to perform correctly, even under the most controlled conditions.

Limited space beside the patient may make giving CPR compressions difficult. Rescuers may need to straddle the patient's hips and give compressions from that position. Care will be needed to landmark correctly. Regular CPR exercises should be practiced in your FRC to help develop a strategy for overcoming the limitations of the craft.

- Avoiding Human error among SAR Personnel, IMO LSR 26/5, 1994.
- Beaulé, Étienne: Module de formation Chefs d'équipe, Canadian Coast Guard, Laurentian Region, 1998.
- Bridge Resource Management – Student's Workbook, Edition 6, Sweden, SAS Flight Academy AB, 1993.
- Canadian Coast Guard Auxiliary, Central and Arctic region: Fundamentals of SAR, 1996.
- Canadian Coast Guard Auxiliary, National Guidelines Respecting Canadian Coast Guard Auxiliary Activities, 1998.
- Canadian Coast Guard, Bridge Resource Management Course, Canadian Coast Guard College, 1998.
- Canadian Coast Guard, Central & Arctic Region IRB Training Manual.
- Canadian Coast Guard, Courtesy examination manual for small craft.
- Canadian Coast Guard, Gaetan Gamelin, Mécanique préventive, Laurentian Region.
- Canadian Coast Guard, Jacky Roy & Jean-Michel Boulais, L'équipage ESC devant la loi, Laurentian Region.
- Canadian Coast Guard, Mathieu Vachon, Formation des équipages en embarcation rapide de secours, Laurentian Region, 1999.
- Canadian Coast Guard, Operational guidelines for Search and Rescue units, 1993.
- Canadian Coast Guard Regional Manual for Marine Rescue Operations, Laurentian Region, DFO 5675/1998.
- Canadian Coast Guard, René Paquet, Les effets du stress post traumatique, Laurentian Region.
- Canadian Coast Guard, Robert Jinchereau, Notes de cours, Laurentian Region.
- Canadian Coast Guard, RHIOT Manual, Pacific Region, Bamfield RHIOT Shool.
- Canadian Coast Guard, SAR Skills Training Standard, TP-9224E, 1994.
- Canadian Coast Guard: Small fishing vessel safety manual, 1993.
- Canadian Power Squadron, Pleasure Craft Operator Course, Motor and Sail, 1990.

Fisheries and Oceans Canada, Coast Guard, Maritime Search and Rescue in Canada, T 31-87/1996E.

Fisheries and Oceans Canada, Coast Guard / Transport Canada Marine Safety: Global Maritime Distress and Safety System, 1997.

Fisheries and Oceans Canada, Coast Guard, Safe Boating Guide, 2000.

International Civil Aviation Organisation and International Maritime Organisation: International Aeronautical and Maritime SAR Manual, IAMSAR Vol. I, II, III.

National Defence / Fisheries and Oceans Canada / Coast Guard: National Search and Rescue Manual, B-GA-209-001, DFO 5449, 1998.

North Pacific Vessel Owner's Association, Vessel Safety Manual, 1986

St. John Ambulance, First Aid, First on the scene, standard level, activity book, 1999.

Stanley R. Trollip, Richard S, Jensen, Human Factors for General Aviation, Englewood, Jeppesen Sanderson, 1991.

United States Coast Guard, Boat Crew Seamanship Manual, U.S. Department of transportation.

World Health Organisation, International Medical Guide, 1989.

Zodiac Hurricane Technologies, Technical Manual, 733 OB Rescue, British Columbia.