



Agriculture and
Agri-Food Canada

Prairie Farm Rehabilitation
Administration

Agriculture et
Agroalimentaire Canada

Administration du r
agricole des Prairies

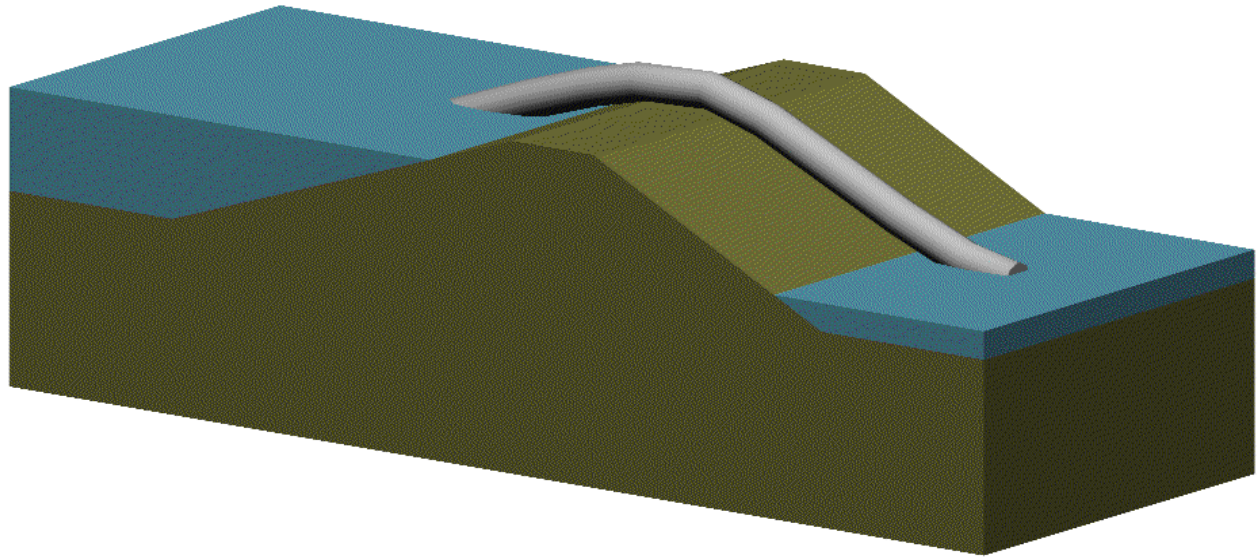

WATER CONVEYANCE WITH SYPHONS

September, 2000

TABLE OF CONTENTS

<u>Section</u>	<u>Page</u>
1.0 Introduction	1
2.0 Pipeline Hydraulics	1
3.0 Priming	3
4.0 Air Release From Liquid-Gas Solutions	4
5.0 Structural Integrity of the Pipe	7
6.0 Inlet Submergence to Prevent Air Admittance	10
7.0 Examples	11
8.0 References	17

1.0 Introduction

Anyone who's made their own beer or wine (or removed gasoline from an unattended vehicle) can easily relate to the concept of using a syphon to convey liquid from one place to another over an elevated obstacle, without the need for continuous pumping. Syphons enable us to employ gravity to continuously convey liquids, with the only energy requirement being a one-time, short-term action to prime the syphon. This monograph discusses some of the technical aspects related to designing and evaluating syphons for use in agricultural operations.

2.0 Pipeline Hydraulics

Any discussion of syphons has to begin with an understanding of the basic hydraulic aspects of closed-conduit flow. The following diagram illustrates the basic concepts behind the analysis of steady flow of an incompressible fluid in a pipe:

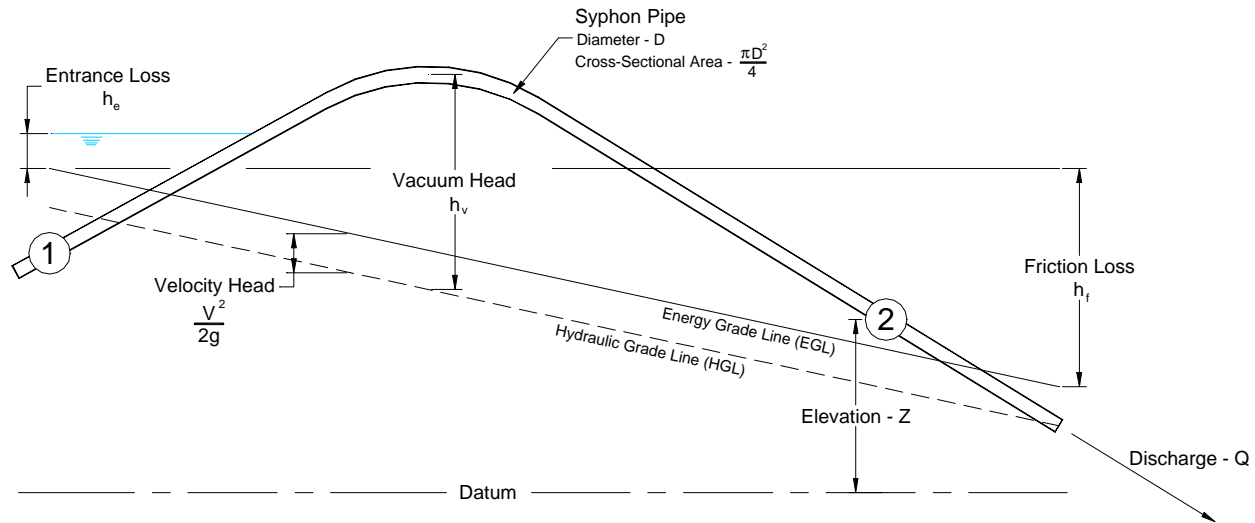

Analysis of this situation assumes that the total energy at any point in the system remains unchanged (noting that total energy includes energy losses incurred as the fluid accelerates, decelerates or moves). This situation can be mathematically abstracted in the following manner:

$$\frac{V_1^2}{2g} + \frac{p_1}{\gamma} + Z_1 = \frac{V_2^2}{2g} + \frac{p_2}{\gamma} + Z_2 + h_f$$

where,...

ρ = pressure (Pa)
 γ = unit weight of fluid (N/m^3)
 $\gamma = 9,806 \text{ N/m}^3$ for water

V = mean velocity at a section (m/s)
 Q = discharge/cross-sectional flow area

Z = elevation above some common datum (m)

h_f = energy losses (m)

g = gravitational acceleration (9.81 m/s^2)

with the subscripts denoting the location or section where the various quantities are evaluated.

It should be noted that h_f , like all the other terms in the equation, has units of length, rather than energy, even though the above equation is essentially an energy-balance expression. The other terms are referred to in the following manner,...

$$\frac{V^2}{2g} \text{ ' Velocity head} \quad Z \text{ ' Elevation head} \quad \frac{p}{\rho} \text{ ' Pressure head}$$

Analysis of this situation requires that there be some means of evaluating the losses in the system. The entrance loss is usually taken to be about half a velocity head, or $0.5V^2/2g$, and the exit loss, where applicable, is approximately equal to one velocity head.

The friction loss is dependent on the rate of flow through the pipe, and the length of pipe between sections being evaluated. There are a number of expressions available for evaluating friction losses, but the most commonly used is the Hazen-Williams equation,...

$$h_f \text{ ' } \frac{6.84L\left(\frac{V}{C}\right)^{1.85}}{D^{1.167}}$$

where,...

$$\begin{aligned} h_f &= \text{friction loss (m)} & L &= \text{length (m)} \\ D &= \text{diameter of pipe (m)} & V &= \text{Velocity (m/s)} \\ C &= \text{Hazen-Williams coefficient} \end{aligned}$$

The Hazen-Williams coefficient varies according to the type and size of pipe being used. The following table gives typical values of C for various pipe sizes and materials.

Hazen-Williams Coefficient		
Type of Pipe	D<560 mm	D>610 mm
PVC; Polyethylene	137	145
Smooth Concrete; AC	135	
Steel; Aluminum	137	145
Sources: Engineering Standards for Design and Construction of Projects Under the IRE Program , Alberta Agriculture, 1991 Ameron Design Manual 301 Pipeline Design for Water Engineers , D. Stephenson, 1981		

Other losses can take place in a pipeline, such as losses at sharp bends, at transitions from one pipe size to another, and at mechanical devices such as valves. However, these "minor" losses, which include the entrance and exit losses, are not usually appreciable, especially in "long" pipes.

It can be seen that the energy equation can be solved for the pressure at some location, as long as the discharge, pipe diameter, pipe profile, and pressure at one point are known. However, a more common situation is one where the water levels at the upstream and downstream ends are known and the profile of the alignment is known, but it is desired to determine the discharge that can be achieved with a pipe of a given size or the required pipe size to deliver a given discharge. Solution of this kind of problem cannot be achieved in closed form, but must be arrived at iteratively - that is, by trial and error. That being the case, the problem is ideally suited to solution using a computer. However, in the situation of a "long" pipe (one where the friction loss is about an order of magnitude greater than the combined minor losses such as entrance and exit losses) the required discharge or pipe diameter can be determined directly from the Hazen-Williams equation by assuming that the entire loss in the system (H) is the friction loss h_f , and that this quantity can be approximated as the difference in elevation between the upstream and downstream water levels. The following equations are the rearranged forms of the Hazen-Williams equation which facilitate these calculations:

To solve for D
when Q is known,...

$$D = 1.63 \left(\frac{L}{H}\right)^{0.206} \left(\frac{Q}{C}\right)^{0.380}$$

To solve for Q
when D is known,...

$$Q = 0.274C D^{2.632} \left(\frac{H}{L}\right)^{0.542}$$

Examination of the definition sketch also reveals another aspect of flow that is peculiar to syphons. The vertical distance between the hydraulic grade line (HGL) and the axis of the pipe at any location is referred to as the piezometric head. In normal, pressurized pipe flow, the hydraulic grade line is always above the axis of the pipe, and it indicates the level to which water would rise in a standpipe inserted in the pipeline at the location of interest. In the case of a syphon, the hydraulic grade line is below the axis of the pipe over much of its length, and the internal pressure is negative, or there is a partial vacuum (referred to as Vacuum Head in the definition sketch). The fact that negative pressures exist is the reason that syphons work (syphons suck), but it also introduces complications or constraints due to the physical nature of fluids. These complications will be discussed in Section 4.0.

3.0 Priming

As mentioned in the introduction, syphons require a short-term input of energy to initiate discharge, a process referred to as "priming". In this process, the pipe being used to convey the liquid must be filled with the liquid such that no air exists in the line, and the piezometric level of fluid at the downstream end is lower than that of the upstream reservoir, as shown in the following sketch:

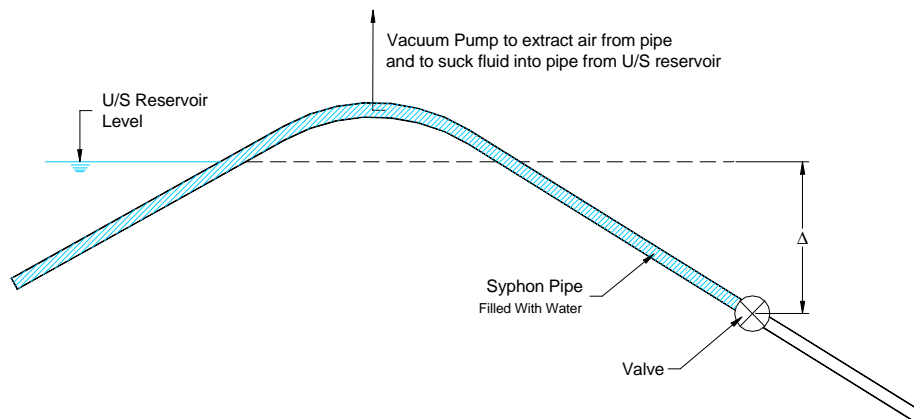

This sketch illustrates a situation where a valve is closed on the downstream side, and a vacuum pump extracts air and sucks fluid into the pipe from the crown. Once the pipe is full, the tap-off on the crown would be closed, and the valve on the downstream side opened to initiate flow in the syphon. Flow can be stopped by closing the downstream valve, or by admitting air by opening the tap-off at the crown. Another method of priming could be to pump the pipe full of fluid from any point along the line, as long as the rate of inflow exceeds the rate of outflow from the ends (in the situation where the ends cannot be closed off with valves or plugs).

4.0 Air Release From Liquid-Gas Solutions

Most liquids contain dissolved gases in solution, and the stability of this liquid-gas solution depends on temperature and pressure. If the pressure experienced by a liquid-gas solution is reduced enough, it will eventually reach the **vapour pressure** of the liquid (for a given temperature). This will also happen if the pressure remains constant, but temperature increases (an example is the boiling of water - the pressure is constant at atmospheric pressure, but the temperature increases). When vapour pressure is reached, the gas dissolved in the liquid will devolve rapidly and in large quantities (the liquid will boil). The following chart illustrates the relationship between vapour pressure and temperature for water.

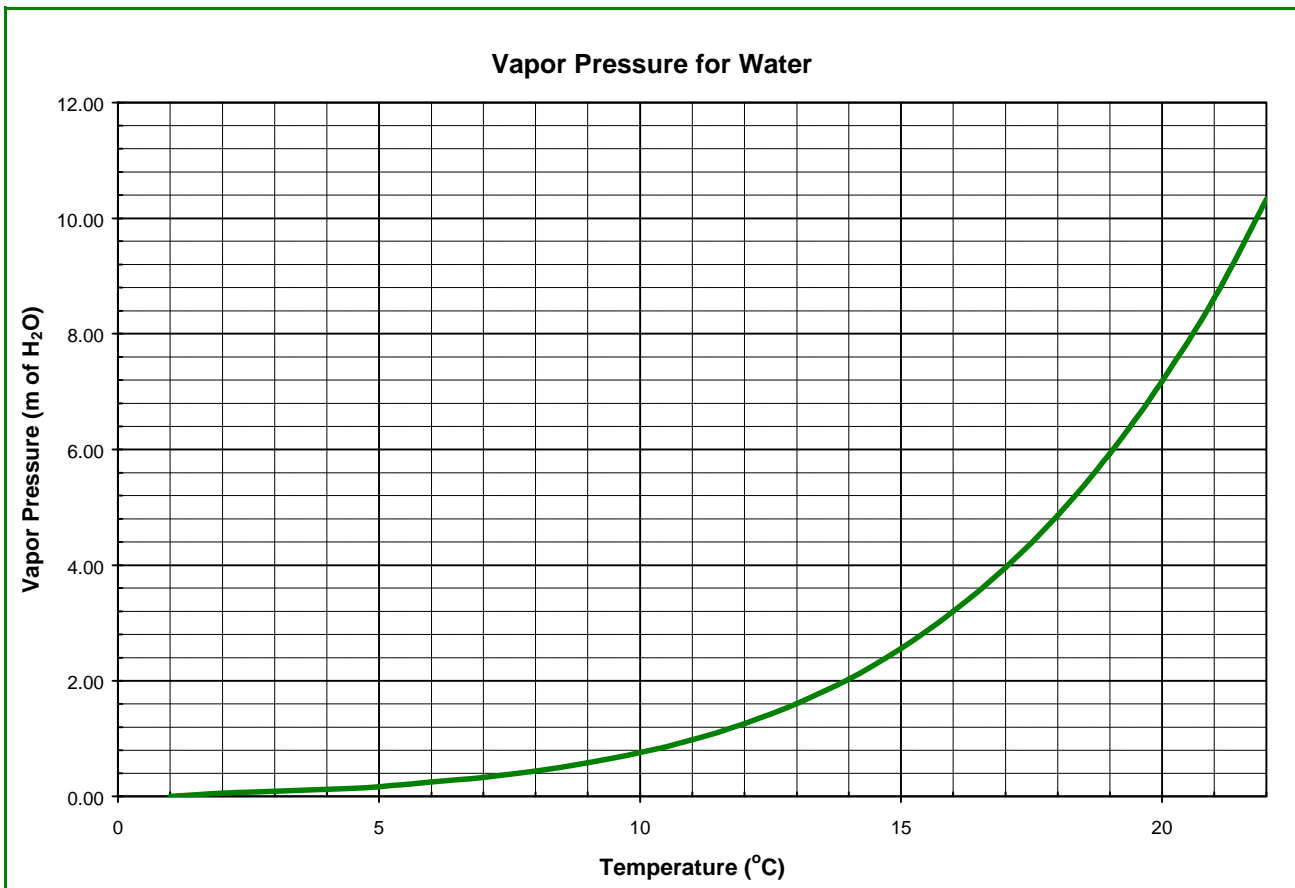

The preceding chart is for *absolute* pressure. In our syphon example, we would have to measure vapour pressure relative to atmospheric pressure, since both the upstream and downstream ends are exposed to the atmosphere. The boiling point of a liquid is defined as the temperature where the liquid boils at atmospheric pressure, so for water temperatures below 100°C, vapour pressure relative to atmospheric pressure would be negative. For example, if the water temperature were anywhere between about 0°C and 20°C, the water flowing in the syphon would begin to boil at any location where the hydraulic grade line was more than about 10 m below the axis of the pipe¹.

This phenomenon places the most severe constraint on the use of syphons, because if the liquid being conveyed by the syphon devolves gas by boiling, a vapour cavity will soon form at the high point, which will result in the rapid reduction and eventual stoppage of flow.

Gas can also devolve from a liquid even at pressures above vapour pressure; the process just occurs more slowly. The saturation point for any solution is another quantity that is dependent on temperature and pressure. For a given temperature and quantity of solute, a liquid-air solution may be unsaturated at one pressure, but saturated for a lower pressure. The pressure at which the solution is saturated (for a given temperature) is called the **saturation pressure**. If the pressure drops below saturation pressure (which is higher than vapour pressure), the liquid-air solution becomes super-saturated. Super-saturated solutions are metastable (that is, they will become unstable with a minor perturbation), and gas will devolve or precipitate with the slightest input of energy. The rate of dissolution depends on many factors, such as the solubility of the gas in the liquid, the pressure deficit below saturation pressure, the void-fraction of the free gas, and the degree of agitation the liquid experiences.

As an example, consider effervescent beverages. Opening a bottle of beer results in the beer going from a high pressure to a lower pressure (the atmosphere), but not so low as to result in boiling. Small bubbles (in this case CO₂) devolve from the beer, and continue to do so until the beer becomes flat (that is, gas devolves until the beer/CO₂ solution is no longer super-saturated at the ambient pressure and temperature). Agitation (shaking the beer up) speeds up the process of dissolution. This process will also occur in a syphon, but because the rate of dissolution is so difficult to predict, it is almost impossible to define appropriate design guidelines to prevent it. And, even if reliable methods of predicting the rate and spatial distribution of dissolution were available, the current state-of-the-art regarding the mechanics of two-phase flow of this nature is quite poorly advanced².

-
- ¹ While this may be true under “ideal” conditions, where everything can be predicted at all locations and at all times with some reliability, the calculation methods associated with determining pressures and velocities aren’t that precise, and local variations such as constrictions or blockages could result in conditions where pressures lower than vapor pressure may exist locally, but not in a global sense. A more conservative and appropriate design guideline would be to ensure that the hydraulic grade line does not fall more than about 7 m below the axis of the pipe at any location.
 - ² Rigorous analysis of this phenomenon would depend on the relative size of the bubbles with respect to the pipe, the interfacial surface tension between the fluid and the gas bubble, the viscosity of the fluid, the slope of the pipe, and the velocity of the flow. The fact that some of these quantities are also dependent on other quantities such as temperature and pressure, and the fact that there is also temporal and spatial variation of some of these quantities within the fluid system, makes rigorous analysis virtually impossible.

However, existing knowledge of the process does offer some means of qualitatively defining appropriate operational guidelines. Nevertheless, we need to confine our attention to one or two distinct modes of operation. For this reason, we will only consider the cases where, for a given syphon and head difference across it, the mode of operation will be either “on” or “off”.

In the situation where it is “off”, there can be two scenarios: either the syphon has been broken by admitting air at the crown, or flow has been stopped by closing a valve at the downstream end. In the case where flow ceases due to loss of prime, discussion of air release from liquid-gas solutions is moot; the syphon will have to be re-primed before it can resume operation. In the case where flow is stopped by a valve at the downstream end, devolved gas will have a chance to accumulate in a single, relatively large vapour cavity at the crown. If an attempt is made to re-start the system by opening the valve, attainment of full capacity will require that the shear exerted on the air bubble by the flow be sufficient to sweep the air pocket away, or to gradually “erode” it. The threshold velocity required to remove accumulated air from a pipe by hydraulic means has been studied by a number of authors, but the results of these investigations vary considerably.

In the case where the syphon is “on”, there will be a region where local pressures are higher than vapour pressure, but lower than saturation pressure. In such situations, the rate of dissolution of air is generally fairly slow, and the bubbles are usually quite small, although the rate of dissolution and the size of the bubbles will increase as the pressure approaches vapour pressure. Therefore, if the nature of the flow is sufficient to prevent the small bubbles from coalescing into a larger vapour cavity, and if the bubbles can be kept in “suspension” and carried along with the flow, there should be no adverse consequences from air coming out of solution in this manner. The velocity required to sweep these small bubbles along with the flow would be less than that required to dislodge or remove a larger bubble that had accumulated in a tranquil environment, but, the complexity of the problem defies rigorous analytical treatment. Nevertheless, the following chart, excerpted from reference no. 2, provides a fairly conservative, empirically-based estimate of the discharge requirements for conveying both bubbles and air pockets moving with the flow.

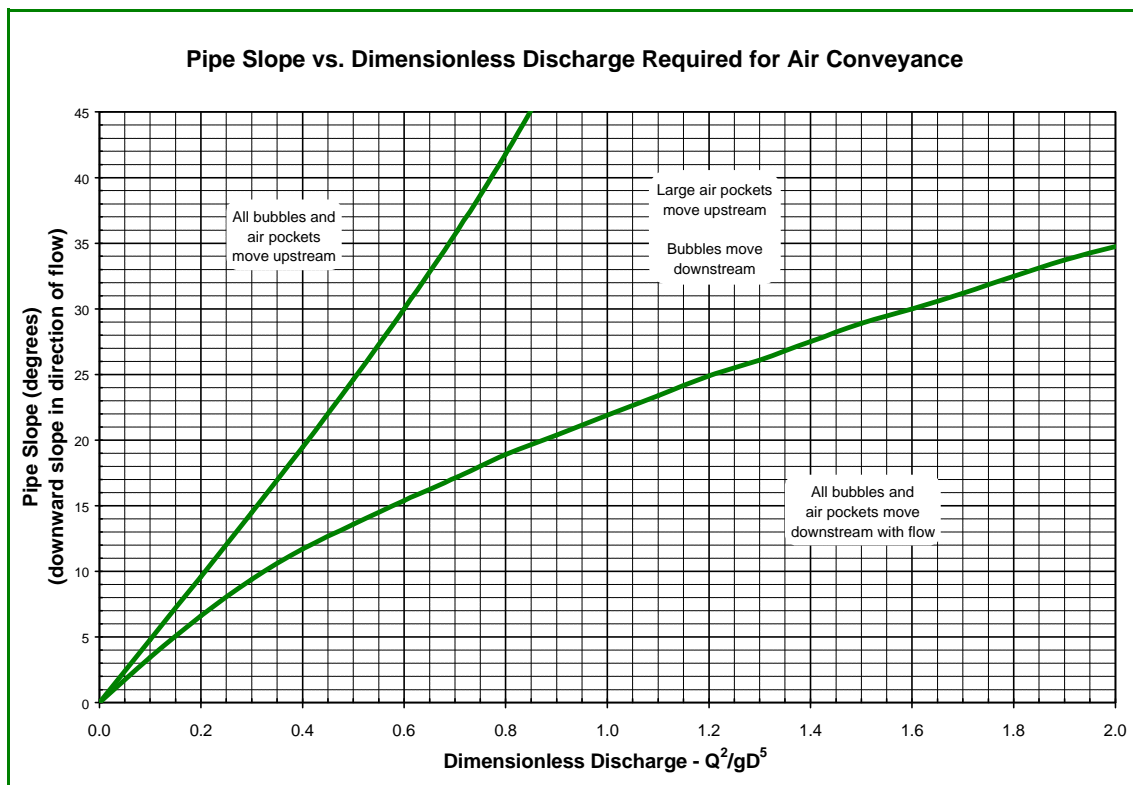

5.0 Structural Integrity of the Pipe

Just as it is important to ensure that a pipe is capable of withstanding internal pressure when designing pressure pipelines, it is also important to ensure that a pipe is capable of withstanding internal vacuum pressures (and external soil loading, if buried) when designing a syphon.

Pipes tend to fail by buckling when subjected to an external hydrostatic load, or an internal vacuum, and the ability of a pipe to withstand these loads depends on the type of material from which it is constructed, the thickness (and shape) of the pipe wall, the size and initial shape of the pipe, and whether the pipe is externally supported (for example, by the surrounding soil in the case of a buried pipe).

For solid-walled pipe, the defining characteristic (besides the material comprising it) is the Dimension Ratio (DR), which is defined as,...

$$DR = \frac{D_o}{t}$$

where,...

D_o = external diameter of the pipe (m)

t = pipe wall thickness (m)

Another factor affecting the buckling strength of an un-supported pipe is its initial ovality, or how much out-of-round it is when loaded. The following sketch illustrates the defining properties in such a situation, and ovality is defined, in percent, as $100 \cdot Y/D$.

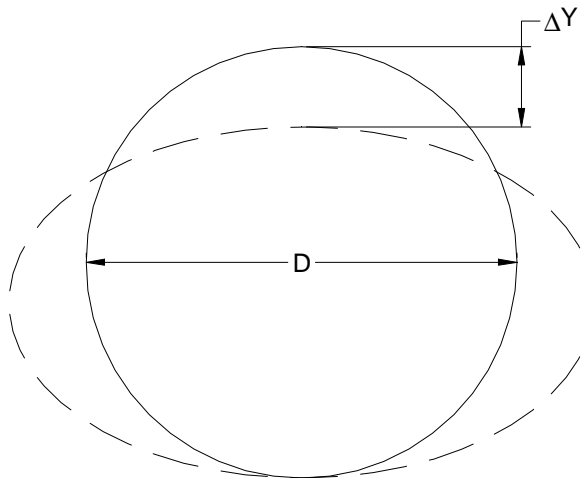

The following chart shows the buckling strength for un-supported pipes composed of various types of material, assuming an initial ovality of about 2% for steel and aluminum, and 10% for PVC and polyethylene. In preparing this chart, a factor-of-safety of 2 was used. In addition to this chart, a further recommendation is that for polyethylene pipe, continuous lengths should be used wherever possible, and that the maximum DR should be about 15, unless strict attention is paid to proper installation.

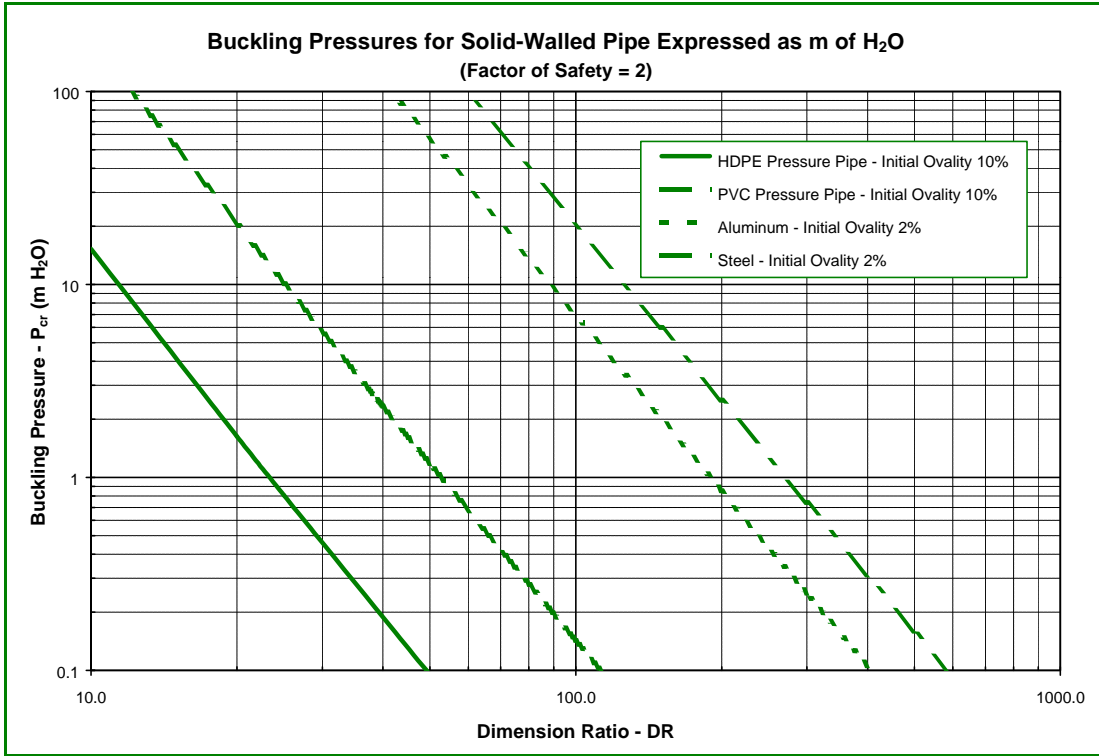

Pipe with a “structured” wall, such as corrugated polyethylene pipe, is defined by its “stiffness”, a quantity that accounts for the shape of the wall, in addition to its thickness. The following chart illustrates the buckling strength characteristics for most commonly-available corrugated polyethylene pipes such as Big”O” or Weholite.

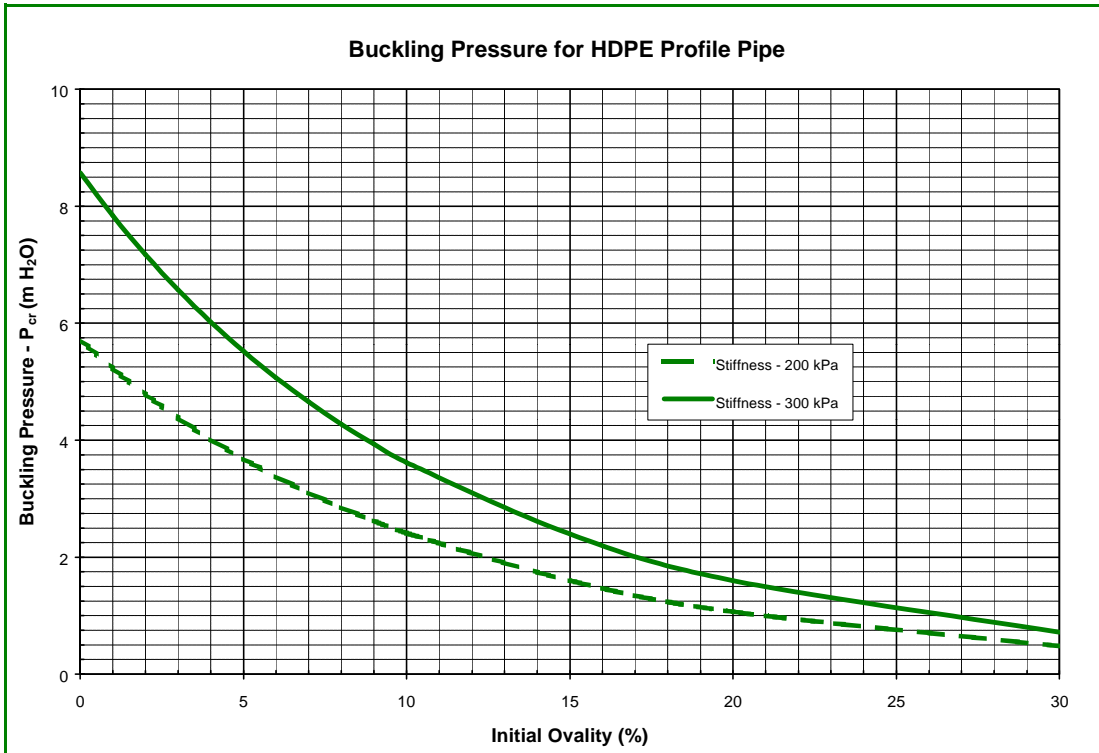

Burying a pipe will add the load of the surrounding soil to the load induced by the internal negative pressure, but, fortunately, burial of the pipe significantly increases its resistance to buckling by providing support around its perimeter. The amount of increase in buckling resistance that can be realized by burying the pipe depends on the type of soil surrounding the pipe, the method of installation, and the degree of compaction of the surrounding soil. The following chart illustrates how the buckling resistance of pipe with support from the surrounding soil increases (relative to an unsupported pipe), assuming that the pipe has no special bedding, that the surrounding soil is a fine-grained medium-plastic material, and that there is little or no compaction of the backfill (dumped material). Such conditions would provide the minimum amount of support that might be achieved, and as such, are conservative assumptions.

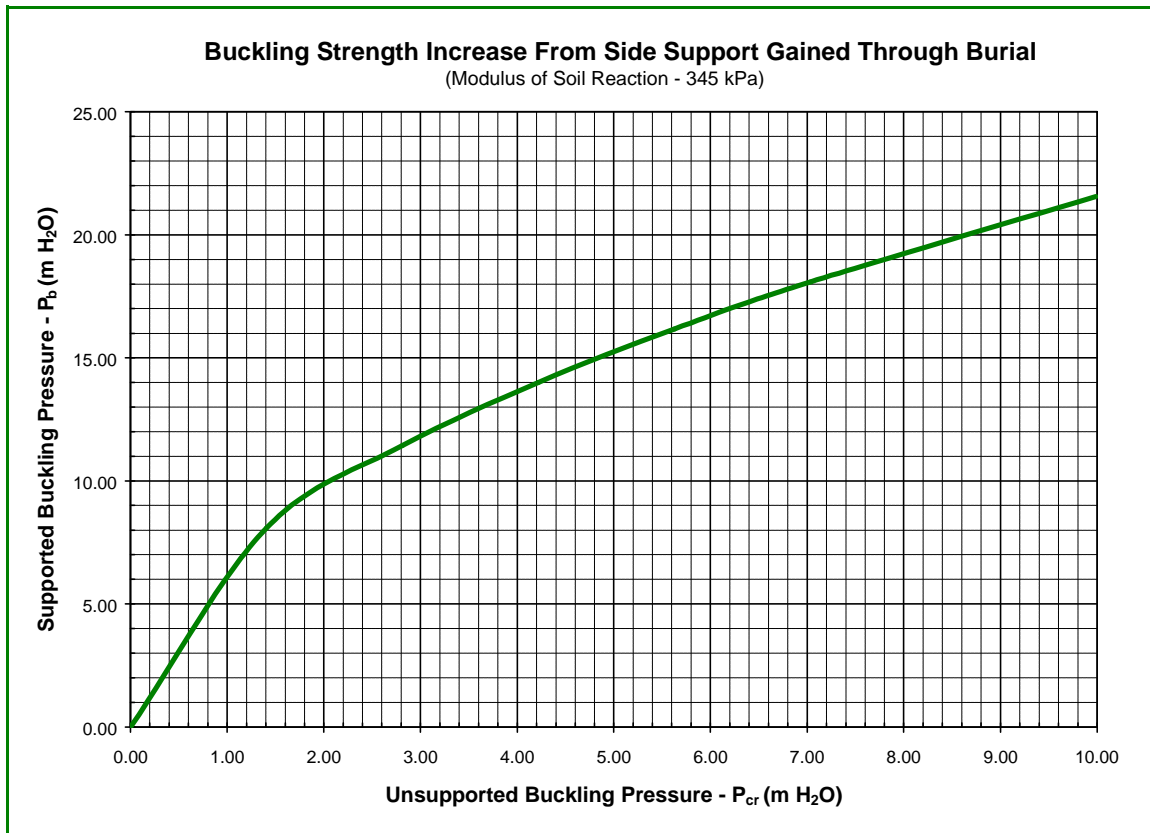

It should be noted when evaluating the ability of a given pipe to withstand vacuum loading, that the couplers used to join individual lengths of pipe may not be as strong as the pipe itself. Joining methods where sections of pipe are “fused” together (such as welding in the case of metals, thermal fusion in the case of polyethylene, and solvent-welding in the case of PVC) result in a finished product of roughly uniform strength throughout. However, coupling devices such as the split-ring couplers used for some corrugated polyethylene pipe, ring-lock couplers on aluminum irrigation pipe, and the threaded joints on some corrugated polyethylene pipe, cannot sustain any vacuum loading. The gasketed bell-and-spigot joints used for PVC pipe are, in some cases, not able to sustain as large a vacuum loading as the pipe. For example, according to the chart which shows the buckling strength of un-supported solid-walled pipe, DR 32 PVC pipe can withstand a vacuum load of about 10 m of H₂O, but IPEX indicates that their gasketed bell-and-spigot joints are tested against a vacuum load of only about 7.75 m of H₂O. In this case, the joints would be the limiting factor in the pipe’s ability to sustain vacuum loading.

6.0 Inlet Submergence to Prevent Air Admittance

Section 4 clearly articulated the importance of ensuring that free air not be allowed to accumulate in the syphon. However, dissolution of dissolved gas from the fluid being conveyed is not the only possible source of air in a syphon. It is possible for air to get “gulped” at the inlet if the inlet is not submerged sufficiently to prevent a vortex from developing and reaching the surface of the reservoir at the upstream end. As an example, consider the case of a bathtub being drained. When the depth of water in the tub falls to a certain level, a vortex intermittently appears above the drain and admits air to the drain. Further reduction in the water level results in the formation of a persistent vortex and the continual admittance of air to the drain pipe.

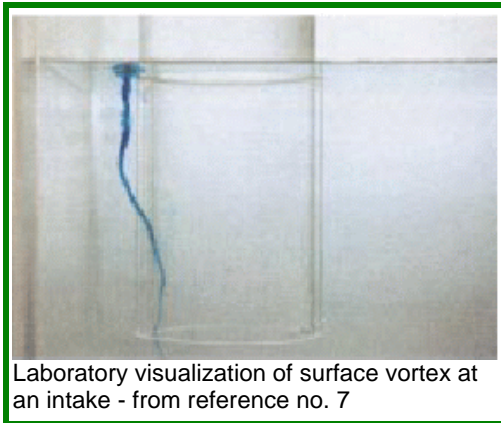

Laboratory visualization of surface vortex at an intake - from reference no. 7

Vortex formation above intakes is a complicated problem in fluid mechanics that does not easily lend itself to an analytical solution. Critical submergence requirements to prevent air-drawing vortices from forming are dependent on the approach-flow patterns and other sources of vorticity in the surrounding media, and hence, a universal value of critical submergence is not meaningful. However, experimental work and observation of field installations has provided some information on which to base an empirical guideline for rationally determining an appropriate level of submergence to prevent air admittance to an inlet due to vortex formation.

For a pipe with a diameter of “D” m, which is conveying a discharge of “Q” m³/s, the average velocity in the pipe will be “V” m/s = $4Q / D^2$. If the intake is located a distance of “h” below the surface of the upstream reservoir, the submergence Froude number, F_s , (a measure of the relative importance of inertial and gravitational forces in the flow) can be defined as,...

$$F_s = \frac{V}{\sqrt{gh}}$$

For pipes with uniform approach flow characteristics, air-core vortices are unlikely to occur if the submergence Froude number is less than about 0.6. However, ensuring that uniform approach-flow conditions exist would require the construction of an inlet structure which meets certain criteria³. For situations with non-uniform approach flow characteristics (which is the most conservative case, and which would likely be the most common situation in practice), the submergence Froude number should be less than about 0.25 to ensure that air is not drawn into the pipe from the surface of the upstream reservoir.

Note that the submergence Froude number can be reduced by enlarging the intake area, and hence reducing the intake velocity. For example, if a D X D X D “tee” were attached to the end of a pipe of diameter D, the intake flow area would be doubled, thereby reducing the intake velocity (and hence F_s) by half. The same effect could be accomplished by plugging the end of the pipe of diameter D, and drilling 200 equally-spaced holes of diameter 0.1D in the wall of the pipe.

³ See Reference No. 3.

Other methods of preventing air from being drawn into the pipe by vortices are to install vortex-suppression devices such as a floating raft anchored to the intake of the pipe.

7.0 Examples

The following section gives examples of typical agricultural applications for syphons.

Example 7.1

Problem

Aromatic Acres Feedlot requires additional water to supply their 5,000 head finishing feedlot. They have an on-site storage facility that is sufficient for about a day's storage, but their wells only produce water at a rate of about 3 L/s (40 igpm). Since the maximum daily water requirements for this operation would be about 430 m³/day⁴, and it is prudent to have a supply capable of meeting this demand, with a day's storage, the feedlot operation requires an additional 2 L/s (25 igpm). A spring with a reported yield in excess of the 2 L/s is reportedly about 600 m away, and about 15 m higher than the feedlot. However, a height of land about 4 m higher than the spring prevents the use of a simple gravity-fed pipeline to convey spring water to the feedlot. Select a syphon that could be used to convey water to the feedlot at the required rate.

Solution

As pointed out in Section 2, this is the kind of problem where rigorous analysis is ideally suited to solution with a computer, because of the iterative nature of the solution. However, this situation is one where the minor losses will be insignificant compared to the friction loss, so it is possible to use the Hazen-Williams equation to solve for the required pipe diameter directly. The defining characteristics of the problem are that the required discharge is 2 L/s, the potential energy available to "drive" the flow is about 15 m (the elevation difference between the spring and the feedlot), and the length of the conveyance route is about 600 m. With this information, a pipe size can be selected. To determine what the necessary pipe strength is, and whether vapour-cavity formation can be avoided, we need to know what the route profile looks like. First, however, we will select a pipe size using the following equation and assuming that the pipe material will be PVC or polyethylene (C=137),...

$$D = 1.63 \left(\frac{L}{H} \right)^{0.206} \left(\frac{Q}{C} \right)^{0.380}$$

It appears as though a 50 mm diameter syphon would be capable of delivering the required discharge with the available head difference. The non-dimensional discharge exceeds that required for air-bubble and air-pocket removal throughout the range of pipe slopes that can reasonably be expected, so vapour lock due to the coalescence of small air bubbles that come out of solution should not be a concern.

If a survey of the route profile is obtained, the hydraulic grade line can be plotted to determine what an appropriate pressure rating for the pipe would be, and whether vapour pressure might be reached anywhere along the route. If we assume that the following chart is a plot of the route profile, then,...

⁴ **The Stockman's Guide to Range Livestock Watering from Surface Water Sources**, Saskatchewan Agriculture and Food and the Prairie Agriculture Machinery Institute.

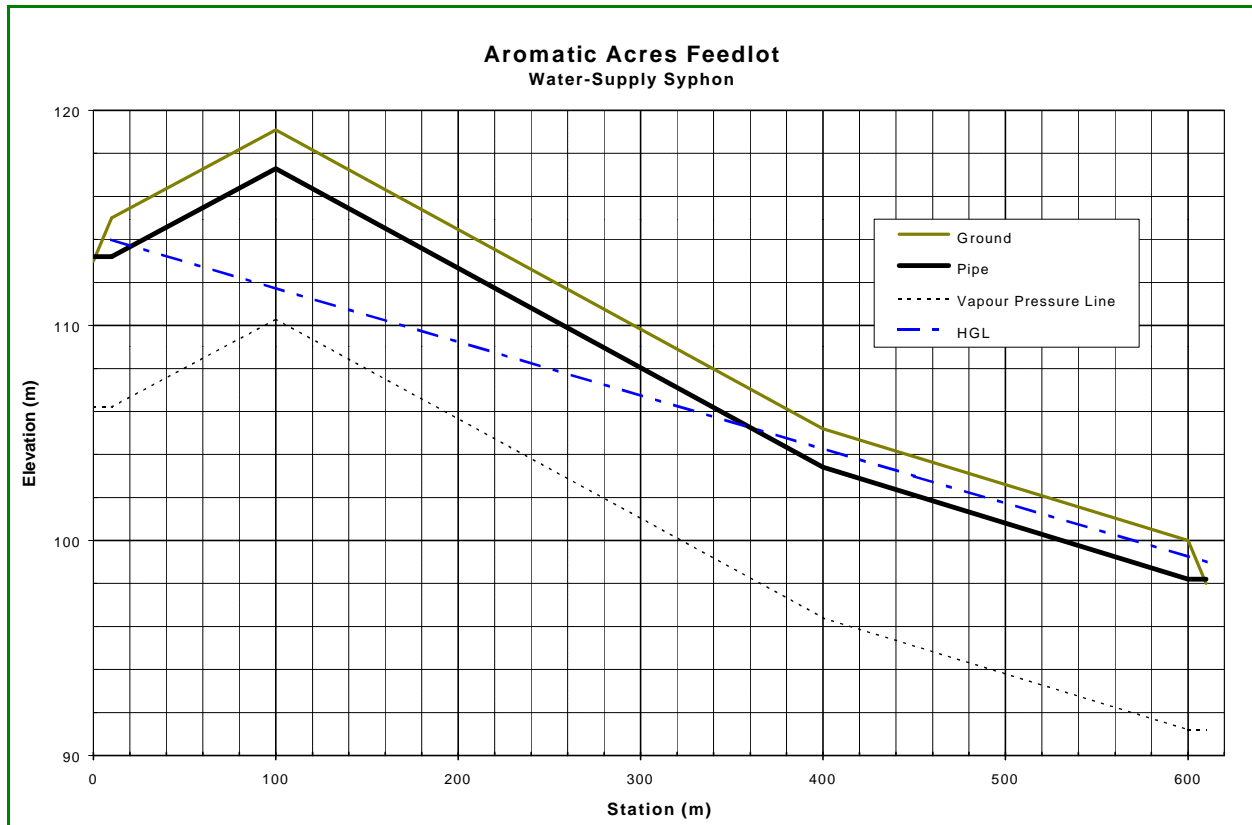

it is clear that the pressure will not drop below vapour pressure anywhere along the route (the maximum negative pressure (vertical distance between the HGL and the pipe) is about 5 m of H_2O). The 1.8 m burial depth of the pipe would mean that an additional pressure equivalent to about 3.5 m of H_2O would have to be withstood (assumes that the density of the soil is about 34 kN/m^3 , and that the pressure exerted on the pipe due to the overlying soil is hydrostatically distributed).

Since the pipe is buried, the additional support provided by the surrounding soil would mean that it would only be necessary for the pipe to have an un-supported buckling strength sufficient to withstand about 1.0 m of H_2O , which could be withstood by a polyethylene pipe having a standard dimension ratio less than about 30 (See section 3). Submergence of the inlet more than about 1.7 m below the water surface at the inlet would be required to prevent air from being sucked into the inlet due to vortex formation.

Example 7.2

Problem

In the previous example, we **assumed** a route profile, and the pipe size chosen for the syphon happened to work out nicely, without any problems like the possibility of vapour cavity formation. However, what if the route is subsequently surveyed, and the **actual** route profile is found to differ from the profile that we assumed, in the following manner,...

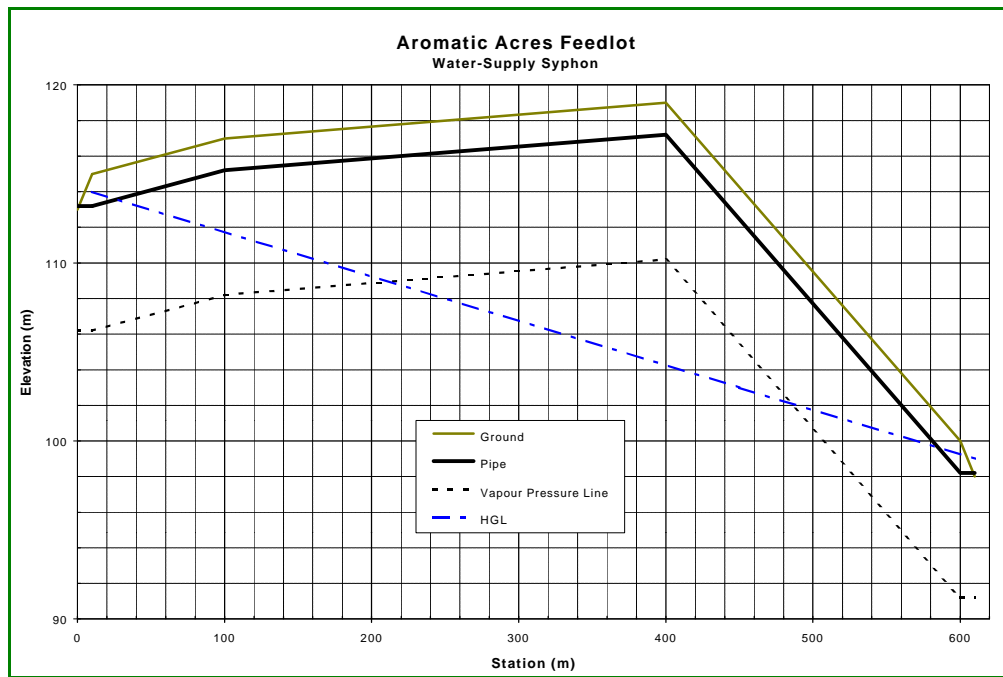

In this case, the hydraulic grade line for a 50 mm diameter syphon would fall below the vapour pressure line between stations 220 and 480, resulting in the risk of vapour cavity formation. One way to overcome this problem would be to have two different sizes of pipe comprising the syphon. The following chart depicts a workable syphon consisting of a 440 m length of 75 mm diameter pipe and a 160 m length of 38 mm diameter pipe. This combination would be capable of delivering the required discharge of 2 L/s with the available head difference, and without vapour cavity formation. Note that the amount of vacuum pressure that would have to be resisted by the pipe in this case would be less than that in the previous case, and the required inlet submergence would also be smaller.

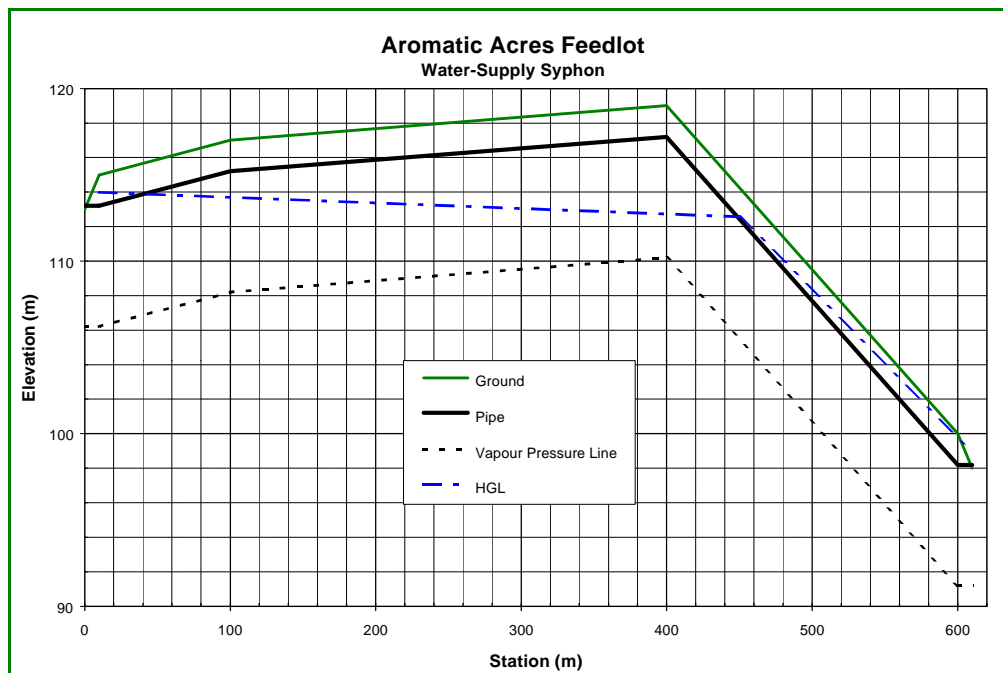

It should be noted that flow in the reach of 75 mm diameter pipe between stations 400 and 440 is in a borderline situation which may not be able to move large air pockets that have been allowed to coalesce (slope of about 5 degrees, dimensionless discharge of about 0.17). It is unlikely that this would pose any problems if operation of the syphon is continuous, but if flow in the syphon is stopped for any length of time, re-priming may be required before full flow capacity can be achieved.

Another way of overcoming the problem posed by the change in route profile would be to install a valve at the downstream end to raise the hydraulic grade line at that location. This would also reduce the head available to drive the flow, meaning that a larger pipe size for the entire length would have to be chosen.

Example 7.3

Problem

Fishfinger Aqua-Farms is planning on building a new aquaculture facility, and they have determined that the maximum water-supply requirement, for their purposes, would be about $2.5 \text{ m}^3/\text{s}$. They are planning on building their facility on a parcel of land adjacent to an irrigation canal, and they plan on using the canal as a water source. The proposed turnout location is immediately upstream of a drop structure, allowing them to operate the facility as a flow-through system where water would be diverted through their raceways and returned to the canal downstream of the drop structure. The drop structure is equipped with an over-shot gate that can be fitted with automatic controls to maintain a constant water level upstream, and therefore, the water level in the canal at the turnout location will be constant. The following figure shows a cross-section of the canal at the location proposed for the turnout, and a schematic representation of the proposed syphon.

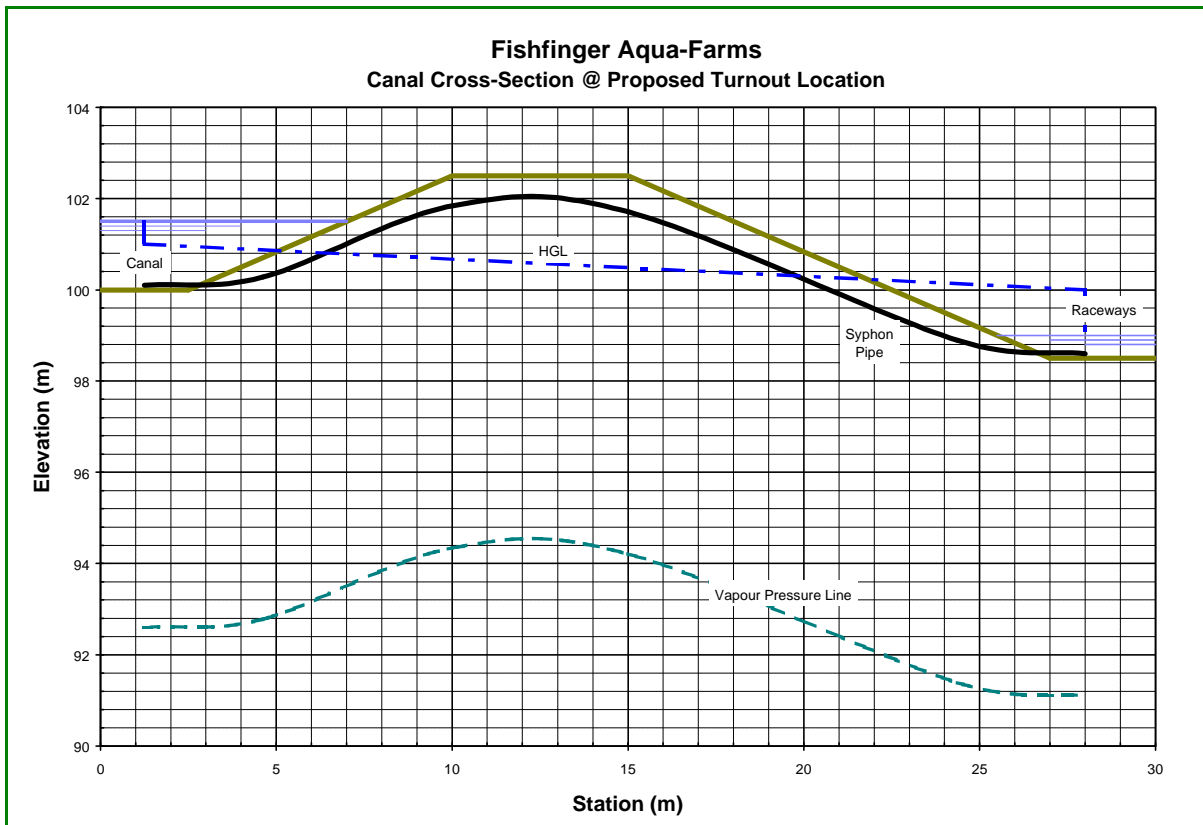

Solution

It appears as though pipe strength requirements will not be a significant concern, so, for the sake of economy, it might be appropriate to use corrugated polyethylene pipe such as Weholite, which can be fused to create air-tight joints. The flexibility of this material would also eliminate the need for fittings. This material comes in standard sizes of 254, 305, 381, 457, 533, 610, 686, 762, 914, 1016, and 1067 mm internal diameters.

The cross-section of the canal at the proposed turnout location indicates that the water depth in the canal, which, as mentioned previously, can be maintained at a relatively constant level, will be about 1.5 m. The outlet of the syphon can be established at a higher elevation than indicated on the sketch, but to facilitate gravity return-flow to the canal downstream, the maximum available head difference across the syphon will be about 2.5 m. The inlet submergence criterion indicates that, to ensure that air-core vortices do not occur, the intake velocity should be less than 1 m/s. If the more relaxed criterion, which assumes uniform approach-flow characteristics is adopted, then the maximum intake velocity would be about 2.3 m/s.

If the maximum downward slope of the syphon matches the 3:1 slope of the canal embankment (about 18°), then the dimensionless discharge should be greater than 0.375 to ensure that small bubbles do not coalesce into a larger cavity, and Q^2/gD^5 should be greater than about 0.75 to ensure that the flow is sufficient to prevent any form of air binding.

The following chart illustrates the head-discharge characteristics of the various pipe sizes, assuming an approximate syphon length of about 30 m, and assuming that the syphon discharges below the surface of the downstream water body. Also depicted on this chart are lines indicating lower operating limits for ensuring that air binding does not occur ($Q^2/gD^5 > 0.375$ and $Q^2/gD^5 > 0.75$). Note that in this situation, the entrance and exit losses will be of the same order as the friction loss.

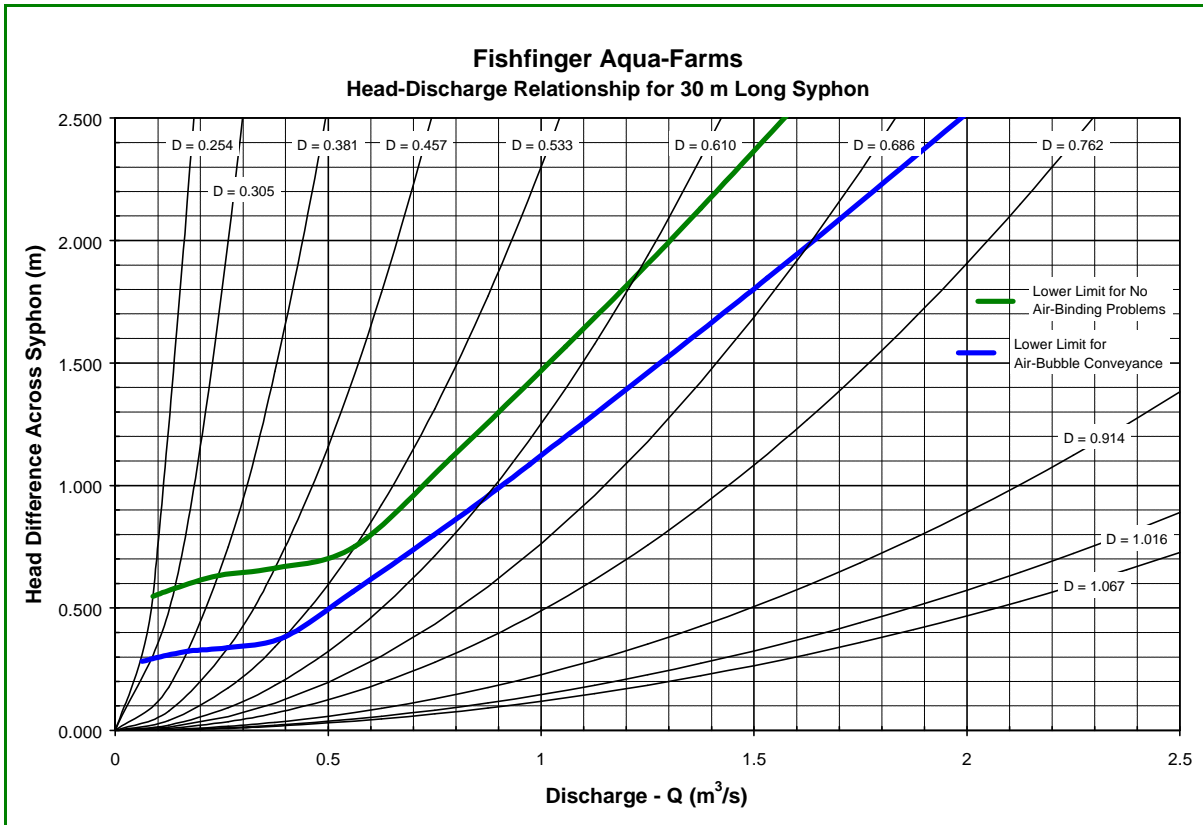

It can be seen from this chart that, while a single pipe larger than about 900 mm in diameter would be capable of delivering the required discharge with the maximum available head difference of 2.5 m, such a syphon would be susceptible to air binding. If two pipes are used, each conveying a discharge of 1.25 m³/s, then a pipe with a diameter of 0.610 m could be used, as long as the available head differential was about 2.0 m. If three pipes were used, each would have to be 0.533 m in diameter, and the available head difference would have to be about 1.6 m. If four pipes were used, then either a 0.457 m diameter or a 0.533 m diameter pipe could be used, but, using the larger pipe size would reduce the inlet submergence requirements. If similar logic is used for the situations where there would be larger numbers of pipes delivering the total required discharge, then the following table could be generated,...

Pipe Size (m)	# of Pipes Required	Pipe Cost (\$/m)	Total Unit Cost (\$/m)	Intake Velocity for DXDXD TEE-Type Intake (m/s)
0.610	2	83	166	2.13
0.533	3	63	189	1.87
0.533	4	63	252	1.40
0.457	5	38	190	1.50
0.457	6	38	228	1.27
0.381	8	34	272	1.37
0.381	10	34	340	1.10
0.254	25	16	400	0.99

The preceding table indicates that the intake velocity would exceed the 1 m/s limit to ensure that air-core vortices do not occur (even if the intake is a DXDXD Tee) for all of the available alternatives, except where 25, 254 mm diameter pipes were used. Such a configuration would be costly, and would probably be impractical from an operational standpoint due to the fact that there would be so many pipes to prime. So, it would seem that regardless of the alternative chosen, it will probably be necessary to include some sort of vortex-suppression device at the inlet (a floating raft anchored above the intakes; cruciform-type inserts in the intake to reduce vorticity, etc.). That being the case, the alternative where two, 610 mm diameter pipes are used would probably be the most desirable option due to operational simplicity and minimum material cost. For this type of installation, the raceways should be laid out so that the water-surface elevation in the raceways at the syphon outfall is about 2.0 m lower than the water surface in the canal.

8.0 References

1. Ducks Unlimited Canada, 1985, **Siphon Use in Alberta**, DU, Hanna, Alberta.
2. Falvey, H. T., **Air-Water Flow in Hydraulic Structures**, Engineering Monograph No. 41, United States Department of the Interior, Water and Power Resources Service, Engineering and Research Center, Denver, Colorado.
3. Hydraulic Institute of the American National Standards Institute, 1994, **American National Standard for Centrifugal Pumps** for Nomenclature, Definitions, Application and Operation, ANSI/HI 1.1-1.5-1994, Hydraulic Institute, Parsippany, New Jersey.
4. Knauss, J., 1987, **Swirling Flow Problems at Intakes - IAHR Hydraulic Structures Design Manual Vol. 1**, A. A. Balkema, Rotterdam.
5. Mortimer, C. E., 1975, **Chemistry - A Conceptual Approach**, 3rd ed., D. Van Nostrand Co., New York, N.Y.
6. Popov, E. P., 1976, **Mechanics of Materials**, 2nd ed., Prentice-Hall Inc., Englewood Cliffs, New Jersey.
7. Rajendran, V. P, Constantinescu, S. G. and Patel, V. C, 1999, *Experimental validation of numerical model of flow In pump-intake bays*, ASCE Journal of Hydraulic Engineering, Vol. 125, No. 11, November, 1999.
8. Richards, R. T, 1957, *Air binding in large pipelines flowing under vacuum*, Proceedings of the American Society of Civil Engineers, Journal of the Hydraulics Division, Vol. 83, No. HY6, December, 1954.
8. Stephenson, D., 1981, **Pipeline Design for Water Engineers**, 2nd ed., Elsevier Scientific Publishing Company, Amsterdam.
9. Streeter, V. L. And Wiley, E. B., 1975, **Fluid Mechanics**, 6th ed., McGraw-Hill Book Company, New York, N.Y.
10. Streeter, V. L. And Wiley, E. B., 1983, **Fluid Transients**, Corrected ed., FEB Press, Ann Arbor, Michigan.
11. Uni-Bell PVC Pipe Assoc., 1993, **Handbook of PVC Pipe - Design and Construction**, Uni-Bell PVC Pipe Assoc., Dallas, Texas.
12. Wisner, P. E. And Moshen, F. N., 1975, *Removal of air from water lines by hydraulic means*, Proceedings of the American Society of Civil Engineers, Journal of the Hydraulics Division, Vol. 83, No. HY2, February, 1975.