



TP 14335 E



# Winter Navigation on the River and Gulf of St. Lawrence

Practical Notebook for Marine Engineers and Deck Officers  
*January 2005*



Transport Canada Transports Canada

Canada

**WINTER NAVIGATION ON THE ST. LAWRENCE RIVER  
PRACTICAL NOTEBOOK  
FOR MARINE ENGINEERS AND DECK OFFICERS**

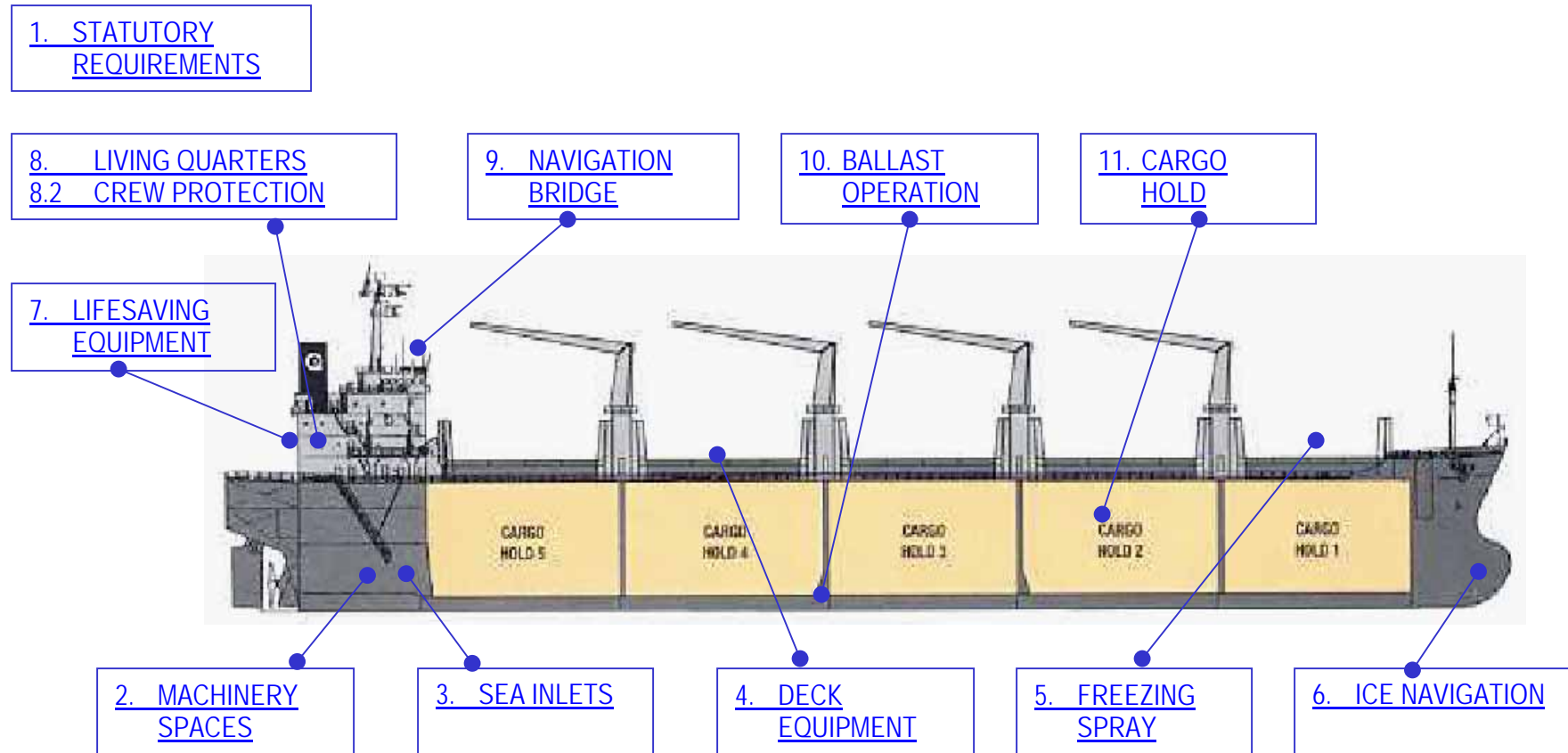

**This document addresses :**

- **Design**
- **Management**
- **Troubleshooting**

# TABLE OF CONTENTS

<b>FOREWORD</b> .....	<b>1</b>
<b>NOTICE</b> .....	<b>1</b>
<b>INTRODUCTION</b> .....	<b>2</b>
<b>1. STATUTORY REQUIREMENTS</b> .....	<b>3</b>
NON STATUTORY REQUIREMENTS.....	3
<b>2. MACHINERY SPACES</b> .....	<b>5</b>
2.1 ENGINE-ROOM.....	5
2.2 SANITARY SYSTEM.....	6
2.3 HYDRAULIC PUMP ROOMS .....	6
2.4 STEERING GEAR FLAT COMPARTMENT .....	6
2.5 ALL UNDER DECK PASSAGES AND DUCT KEEL.....	6
2.6 BOW THRUSTER ROOM .....	6
2.7 EMERGENCY GENERATOR ROOM .....	7
2.8 EMERGENCY FIRE PUMP ROOM.....	7
2.9 CO <sub>2</sub> ROOMS AND OTHER FIREFIGHTING ROOMS .....	7
2.10 CLASSIFICATION SOCIETY NOTIFICATION .....	7
<b>3. SEA INLET BOXES</b> .....	<b>8</b>
3.1 GUIDANCE ON DESIGN AND CONSTRUCTION OF SEA INLETS UNDER SLUSH AND ICE CONDITIONS.....	8
3.2 IMO SUGGESTED ARRANGEMENT (MSC/CIRC.504) .....	9
3.2.1 <i>THE SEABAY</i> .....	9
3.2.2 <i>THE SEA BOXES</i> .....	9
3.3 WEIR-TYPE SEA INLET BOX DESIGN .....	11
3.4 DE-ICING RETURNS ON SEA BOX OR STRAINER WITH AFT SEA INLET .....	12
3.4.1 <i>THE SEA BOXES</i> .....	12
3.5 DE-ICING SYSTEM RETURN(S) ON SEA BOX AND STRAINER INLET .....	13
3.5.1 <i>THE SEA INLET BOXES</i> .....	13
3.6 DE-ICING SYSTEM RETURN AT STRAINER INLET .....	14
3.6.1 <i>THE SEA INLET BOXES</i> .....	14
3.7 TROUBLESHOOTING SEA INLETS PLUGGED BY ICE .....	15
3.7.1 <i>REVIEW</i> .....	15
3.7.2 <i>CLEANING PROCEDURE</i> .....	16
3.8 DE-ICING DESIGN USING BALLAST TANK .....	18
3.9 EMERGENCY DE-ICING SYSTEM ARRANGEMENT .....	20
<b>4. DECK EQUIPMENT</b> .....	<b>21</b>
4.1 DECK LINE .....	21
4.2 FIRE LINE .....	21
4.3 DECK EQUIPMENT.....	22
4.4 CHEMICAL TANKERS .....	23
4.4.1 <i>POSSIBLE SOLUTIONS IN COLD WEATHER</i> .....	23

<b>5. FREEZING SPRAY</b> .....	<b>25</b>
5.1 SHIPBOARD ICE ACCRETION.....	25
5.1.1 <i>SHIP SAFETY BULLETIN</i> .....	25
5.2 ANCHORS .....	26
5.3 RISKS AND CONSEQUENCES .....	26
<b>6. ICE NAVIGATION</b> .....	<b>34</b>
6.1 POSSIBLE HULL DAMAGE .....	34
<b>7. LIFESAVING APPLIANCES</b> .....	<b>35</b>
7.1 LIFEBOAT AND SURVIVAL CRAFT.....	35
7.2 LIFEBOAT PROPULSION.....	35
7.2.1 <i>FUEL OIL</i> .....	35
7.2.2 <i>LUBRICATING OIL</i> .....	36
7.2.3 <i>ELECTRIC HEATER</i> .....	36
7.2.4 <i>WATER COOLED ENGINE</i> .....	37
7.3 DAVITS.....	37
7.4 LIFERAFTS.....	37
<b>8. LIVING QUARTERS</b> .....	<b>38</b>
8.1 ACCOMMODATION .....	38
8.2 CREW PROTECTION.....	38
<b>9. NAVIGATION BRIDGE</b> .....	<b>44</b>
<b>10. BALLAST OPERATION</b> .....	<b>46</b>
10.1 BALLAST – CARGO CONDITION .....	46
10.2 COLD WEATHER PRECAUTION PROCEDURES WITH BALLAST .....	46
<b>11. CARGO HOLD</b> .....	<b>55</b>
11.1 TANKER – CARGO HEATING SYSTEMS .....	55
11.2 CARGO .....	55
11.3 SAFETY NOTICE .....	56

## FOREWORD

Seafarers that are not familiar with vessels operating in ice conditions may not fully appreciate the risks involved and in consequence may not be adequately prepared. This notebook is a complement to the regulatory required Canadian Coast Guard, Fisheries and Oceans official publication, TP 5064 “*ICE NAVIGATION IN CANADIAN WATERS*” and is intended for use by ships’ owner and operator, charterers, agents and ships’ senior officers who seek practical information on the ship’s, response and operation, as well as to provide a better understanding of hazards which may be encountered when transiting Eastern Canadian ice covered waters during the winter navigation season.

Ice conditions are treacherous in the St. Lawrence River, especially the passage between the east point of Île d’Orleans to just beyond the Quebec bridges. Freshwater, current, water depth and tide are factors that contribute pushing frazil ice down to depths of 10 meters or more, which could easily plug seawater cooling inlets. These conditions are found in many areas of the St. Lawrence River, especially so, in this sector. This is an unusual occurrence and is rarely encountered elsewhere in any other parts of the world.

## NOTICE

This notebook should not be viewed as a compulsory publication. The information contained in this document is not exhaustive; its use should not engage the responsibility of Transport Canada (TC) nor should it replace or affect existing regulation. TC makes no promises and does not guarantee safe ship passage through ice-covered waters.

We wish to further improve this document at a later date.

We would appreciate any additional comments and recommendations for enhancing this notebook. Please address these suggestions to :

Transport Canada  
Marine Safety  
901, Cap-Diamant, 4<sup>th</sup> Floor  
Québec (Québec) G1K 4K1

c/o Mr. André Desrochers  
E-mail : [desroan@tc.gc.ca](mailto:desroan@tc.gc.ca)

Tel : (418) 648-3234  
Fax : (418) 648-5106

## **INTRODUCTION**

Ice damage to vessels can lead to oil spills, a risk that cannot be easily overlooked. Ice navigation calls for special knowledge and precautions even in ice-strengthened ships. Cold weather poses several problems of its own. Winter climatic conditions encountered on the St. Lawrence waterway can bring many unusual problems for mariners having little or no experience in such conditions.

Ships' and their equipment are not always designed or capable to face these conditions. Loss of electrical or propulsive power, equipment damage and restriction of movement could lead to costly downtime and possibly a detention by Port State Control. These are the most frequent troubles that could occur in these particular conditions.

The goal of this publication is to identify precautions that can be taken and recurring problems encountered every winter season in various locations of a vessel in an attempt to bring practical solutions whether it is temporary or permanent.

This notebook, compiled from different sources, may go a long way in guarding against cold weather damage to a vessel and its equipment.



## 1. STATUTORY REQUIREMENTS

- .1 Every ship of 100 tons gross tonnage, or over, navigating in Eastern Canadian waters in which ice may be encountered is required to carry and make proper navigational use of TP 5064 "Ice Navigation in Canadian Waters".

*Ref : Canada Shipping Act SOR/95-149 Chart and Nautical Publications Regulations, 1995 Section 6(1)d), 6(2)d).*

- .2 Canadian ships which operate in ice covered waters where ice may choke seawater inlet boxes should maintain an essential sea water supply by using diversion arrangements to introduce heated cooling water from overboard discharge lines to seawater inlet boxes;

*Ref: Canada Shipping Act SOR/90-264 CSA 033 Marine Machinery Regulations SCHEDULE VII PART I Division IV.*

- .3 The ISM Code is intended to address risks associated with ship operations and establish well-documented vessel-specific procedures and practices.<sup>1</sup> The crewmembers designated to the vessel are required to possess skills and knowledge essential for the safe execution of tasks they are expected to perform in normal day-to-day operations and during emergency situations.<sup>2</sup>

- .4 Given that a ship that is scheduled to ply in Eastern Canadian waters during the winter season, the ship must be prepared to operate in cold climates and ice infested waters. The ship owner and ship's senior staff should ensure that under the ISM Code, adequate policies and procedures are provided and that all necessary information is available to the ship's complement in order to make sound decisions in any operating conditions. Consequently, it is essential that a complete set of manuals, procedures and practices are readily available for each specific vessel as per ISM Code requirements.

## NON STATUTORY REQUIREMENTS

Publication : "[JOINT INDUSTRY COAST-GUARD GUIDELINES FOR THE CONTROL OF OIL TANKERS AND BULK CHEMICAL CARRIERS IN ICE CONTROL ZONES OF EASTERN CANADA](#)"

---

<sup>1</sup> See Section 1.2 of the ISM Code on next page

<sup>2</sup> See Section 6.2 and 6.3 of the ISM Code on next page

## ***Section 1.2 of the ISM Code***

### ***1.2 Objectives***

***1.2.1*** *The objectives of the Code are to ensure safety at sea, prevention of human injury or loss of life, and avoidance of damage to the environment, in particular to the marine environment and to property.*

***1.2.2*** *Safety management objectives of the Company should, inter alia :*

- .1*** *provide for safe practices in ship operation and a safe working environment;*
- .2*** *establish safeguards against all identified risks; and*
- .3*** *continuously improve safety management skills of personnel ashore and aboard ships, including preparing for emergencies related both to safety and environmental protection.*

***1.2.3*** *The safety management system should ensure :*

- .1*** *compliance with mandatory rules and regulations; and*
- .2*** *that applicable codes, guidelines and standards recommended by the Organization, Administrations, classification societies and maritime industry organizations are taken into account.*

## ***Section 6.2 and 6.3 of the ISM Code***

### ***6 Resources and Personnel***

***6.2*** *The Company should ensure that each ship is manned with qualified, certificated and medically fit seafarers in accordance with national and international requirements.*

***6.3*** *The Company should establish procedures to ensure that new personnel and personnel transferred to new assignments related to safety and protection of the environment are given proper familiarization with their duties. Instructions which are essential to be provided prior to sailing should be identified, documented and given.*



## 2. MACHINERY SPACES

Freezing of deck and engine-room systems are the most common problems for foreign ships navigating in cold climates and ice-covered waters. Engine-room personnel should be aware of these potential problems and solutions available to them. **The engine-room should not be left unattended in restricted or ice covered waters.**

The following is a list of possible actions to be taken if such environmental conditions prevail.

### 2.1 ENGINE-ROOM

- a) Compartment space heater on.
- b) Ensure moisture free air for control air, whistle and deck services.
- c) Reduce ventilation and/or provide shields to avoid direct cold airflow against control and gauging equipment and small diameter piping systems.
- d) Reduce the flow of outside air into the engine-room spaces by closing down the vent fans and throttling the dampers. In a turbine vessel, opening a skylight or hatchway to the forced draft fan outlet, will short-circuit the normal air circulation and thereby provide warmer machinery spaces.
- e) With a diesel driven ship, the closing of dampers and a reduction in the ventilation will not create a higher than normal vacuum to build-up inside engine-room spaces. Recirculating air in the engine-room should be avoided as this will result in a higher content of aromatic hydrocarbon and noxious gases.
- f) Keep funnel flaps shut on unused boiler (beware of reverse cold draft).
- g) Activate seawater recirculation system. Direct heated seawater from overboard discharge lines to low sea suction box by keeping overboard discharge valve in near closed position.
- h) Monitor suction and discharge pressures of seawater pumps and carry out steam injection if any signs of ice formation are noticed in sea box. This is determined by pressure/flow fluctuations. Steam injection hoses to be kept ready. Open steam to sea<sup>3</sup> boxes and overboard discharge valve, if required.
- i) Change over to ballast seawater recirculating tank if fitted.
- j) Circulate freshwater continuously to eliminate any possibility of freezing.
- k) Oil tank heaters on (keep steam valve cracked open to prevent bursting of pipe).
- l) Keep all steam tracing lines active.
- m) Heat-up diesel oil settling and service tank to 30° C.
- n) Clean diesel oil filters daily to prevent wax accumulation.

---

<sup>3</sup> Experience in Canada demonstrated that even in light ice condition this provision alone proved to be inadequate to maintain adequate flow of cooling water.

- o) Lube oil and heavy oil purifiers should be run continuously.
- p) Maintain hotwell temperature for boiler.
- q) Keep sterntube cooling water tank slack (after peak).
- r) Oily-water separator to be drained of all water if exposed.
- s) Monitor domestic freshwater pumps as continuous running is an indication of ruptured piping.

## **2.2 SANITARY SYSTEM**

- a) Maintain a small flow of water through the sanitary system and soil drains.
- b) Apply heating to the sanitary holding tank and overboard line if the ambient space temperature falls below 5° C (41° F); when possible, and if time permits, purge air or steam through all washwater outlets that do not drain to a level well below the water line. If necessary, add a small amount of environmentally safe antifreeze or salt to unused drain traps and toilets or insert rubber hoses.

## **2.3 HYDRAULIC PUMP ROOMS**

- a) Vessel's hydraulic systems should be filled with fluid designed for cold weather operation.
- b) Space heater on.
- c) Oil tank heater on.
- d) Compartment vent closed or use a shield.
- e) A light quantity of 70% isopropyl alcohol will remove moisture in hydraulic oil and ease control mechanisms.

## **2.4 STEERING GEAR FLAT COMPARTMENT**

- a) Space heater on.
- b) If no space heater, run hydraulic pumps continuously and use low temperature oil.
- c) Oil tank heater on.
- d) Compartment vent closed or use a shield.

## **2.5 ALL UNDER DECK PASSAGES AND DUCT KEEL**

- a) Space heater on.
- b) Compartment vent closed or use a shield. Beware of any dangerous gas accumulations.

## **2.6 BOW THRUSTER ROOM**

- a) Space heater on.
- b) Oil tank heater on.
- c) Compartment vent closed or use a shield.

## **2.7 EMERGENCY GENERATOR ROOM**

SOLAS II-1, Reg. 44      Emergency generating sets should be capable of being readily started in their cold condition at a temperature of 0° C. If this is impracticable, or if lower temperatures are likely to be encountered, provision acceptable to the Administration should be made for the maintenance of heating arrangements, to ensure ready starting of the generating sets.

Refer to section 7.2 of this guide under “[lifeboat propulsion](#)” for more details concerning fuel, lubricating oil and heater care.

Even though the emergency generator space may be heated, give special attention to the fuel tank that may be found adjacent to an exterior bulkhead, which in turn, can lower the fuel oil temperature to below its cloud point.

- a) Add antifreeze (-35° C) to diesel engine cooling water system.
- b) Space heater on.
- c) Compartment vent closed.

## **2.8 EMERGENCY FIRE PUMP ROOM**

Refer to section 7.2 of this guide under “[lifeboat propulsion](#)” for more details concerning fuel, lubricating oil and heater care.

- a) Add antifreeze (-35° C) to diesel engine cooling water system.
- b) Space heater on.
- c) Compartment vent closed or use a shield.

## **2.9 CO<sub>2</sub> ROOMS AND OTHER FIREFIGHTING ROOMS**

- a) Keep equipment within proper ambient temperatures.
- b) CO<sub>2</sub> systems usually operate only in temperatures above -16° C.

## **2.10 CLASSIFICATION SOCIETY NOTIFICATION**

- a) Classification societies and/or engine manufacturers’ may require notices in case of any modifications.

### 3. SEA INLET BOXES

#### 3.1 GUIDANCE ON DESIGN AND CONSTRUCTION OF SEA INLETS UNDER SLUSH AND ICE CONDITIONS

There is potential for ice and slush to enter seabays or sea inlet boxes, blocking seawater flow to the cooling system. This problem is encountered by a majority of ships entering ice-covered waters. If water cannot be obtained for the cooling system, the engines will not perform properly and may eventually overheat causing engines to shut-down or become seriously damaged.

The design of ships, which operate in ice, must prevent the cooling system from becoming blocked by ice.

As a general principle, winter cooling system should :

- a) Maintain essential seawater by using inlets situated as low and as far aft as possible, near centerline.
- b) Use sea boxes that have the following characteristics :
  - i. should be fitted on each side of the ship.
  - ii. should be as deeply submerged as possible.
  - iii. should have an area open to the sea of five to six times the total area of the pump suctions served by the seabay.
  - iv. should be fitted with a strainer plate at the ship's side having perforations approximately 20 mm diameter to prevent ingestion of large ice particles.
  - v. should be fitted with a low steam pressure connection to clear strainers.
  - vi. should be vented to atmosphere by a valved pipe with a cross-sectional area at least equal to that of the cooling suctions.
- c) Use diversion arrangements to introduce warm cooling water to seawater inlets and strainers.
- d) Provide means to manually clear sea inlets of ice blockage by introducing low compressed air or steam.<sup>4</sup>
- e) Allow ice and slush ice, introduced in the system, to float freely away from pump intakes without undue stirring.
- f) Allow temporary or permanent use of ballast water for two purposes :
  - i. back flushing sea boxes; and
  - ii. cooling the engines as a short-term solution unless a large quantity is available and re-circulated.

---

<sup>4</sup> *Experience in Eastern Canada demonstrated that even in light ice condition this provision alone proved to be inadequate to maintain adequate flow of cooling water.*

Means must be provided to clear seabays when blocked by ice. The following provides some solutions to ensure that cooling water flow is maintained to ship engines.

There are several design features, which can ease operation or eliminate these problems. The following pages show different arrangements of sea inlet box design with a recirculation system. These arrangements are placed in order from 1 through 5 with 1 being the most effective arrangement, followed by operational practices and troubleshooting.

Precautions should be taken to avoid structural damage due to blockage of air pipes by spray ice and ice accumulation. Air pipes serving cooling systems should be positioned in protected areas or heat traced as a preventive measure.

### **3.2 IMO SUGGESTED ARRANGEMENT (MSC/CIRC.504)**

This circulation system has been used on a number of Canadian ships and provides one possible solution to a sea inlet blocked by ice. The ship should be provided with at least one seabay from which pumps supplying cooling water to essential machinery, can draw.

#### **3.2.1 THE SEABAY**

- a) should be supplied with water from at least two sea inlet boxes; and
- b) should be connected to the sea inlet boxes by pipes, valves and strainers with a cross-sectional area equal to the total area of the suctions served by the seabay.

#### **3.2.2 THE SEA BOXES**

- a) should be fitted on each side of the ship;
- b) should be as deeply submerged as possible;
- c) should have an area open to the sea of five to six times the total area of the pump suctions served by the seabay;
- d) should be fitted with a strainer plate at the ship's side having perforations approximately 20 mm diameter to prevent ingestion of large ice particles;
- e) should be fitted with a low steam pressure connection to clear strainers; and
- f) should be vented to atmosphere by a valved pipe with a cross-sectional area at least equal to that of the cooling suctions.

Diversion valves and piping should be provided at overboard cooling water discharges to permit heated water to return to the sea inlet boxes so as to prevent ice blockage.



### 3.3 WEIR-TYPE SEA INLET BOX DESIGN

A Weir-type sea box is commonly used in Baltic icebreakers, and is illustrated in Figure 3.3. Weir-type will overcome the problem of suction pipe clogging. The suction is separated from the sea inlet grills by a vertical plate weir. Any ice entering the sea box can float to the top and is unlikely to be drawn back down to the suction level.

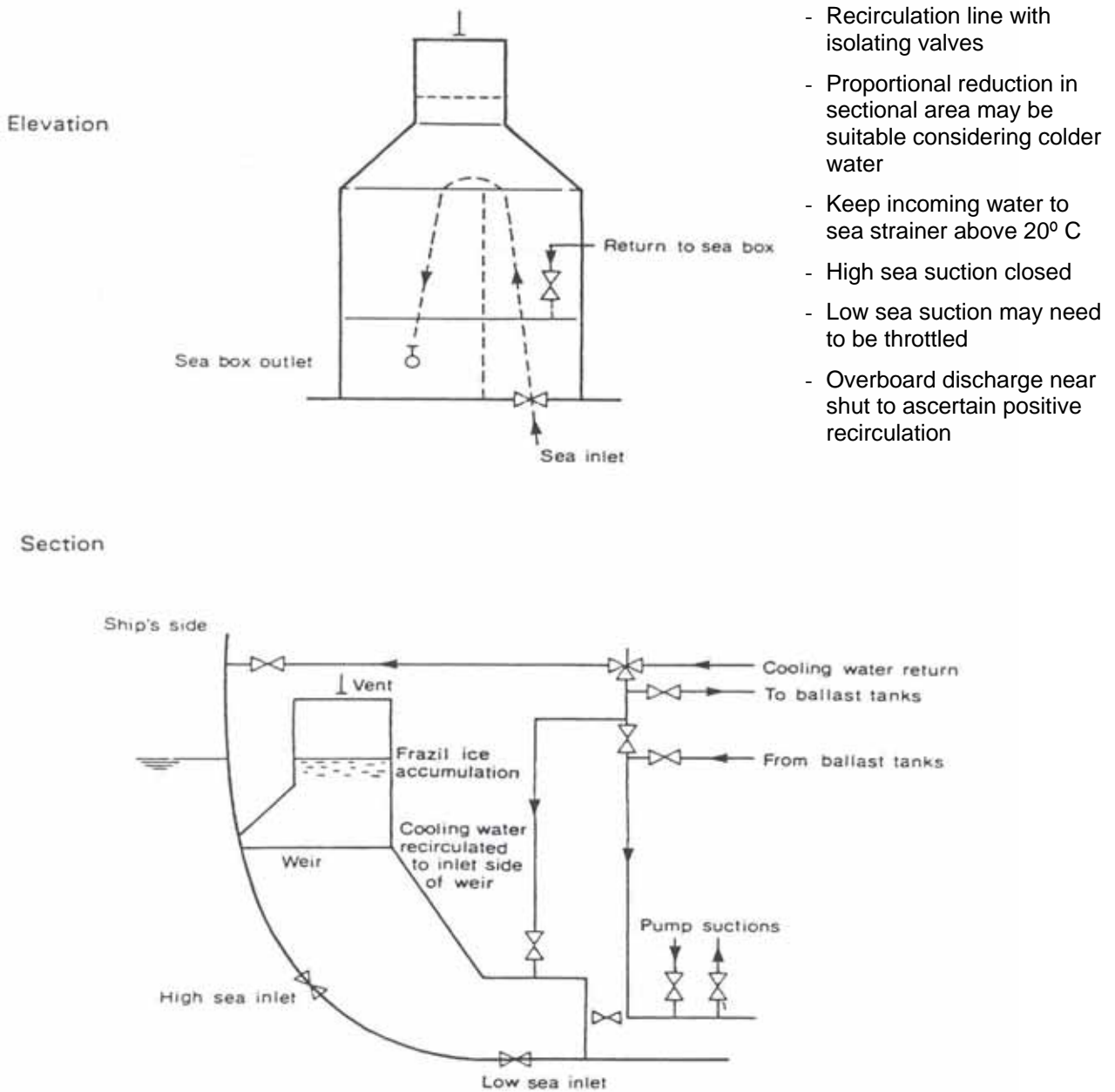

**Figure 3.3 : Weir-type sea inlet boxes design – Elevation and section view**



### 3.4 DE-ICING RETURNS ON SEA BOX OR STRAINER WITH AFT SEA INLET

#### 3.4.1 THE SEA BOXES

- are fitted on one side of the ship and one aft near the centreline;
- are fitted with a low steam pressure connection to clear sea strainers; and
- are vented to atmosphere by a valved pipe with a cross-sectional area specified by a classification society.

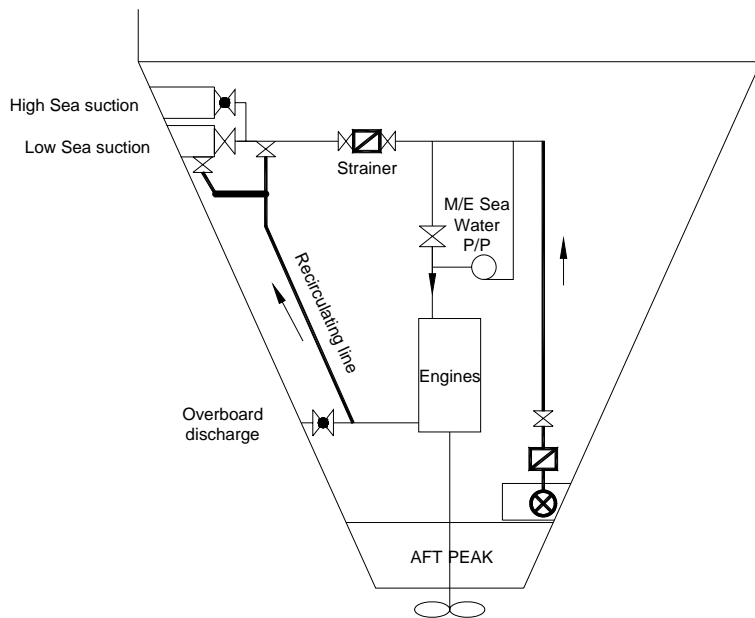

- Recirculation line with isolating valves
- Proportional reduction in sectional area may be suitable considering colder water
- Keep incoming water to sea strainer above 20° C
- High sea suction closed
- Low sea suction may need to be throttled
- Overboard discharge near shut to ascertain positive recirculation

**Figure 3.4 : De-icing design returns on sea box or strainer with aft sea inlet – Plan view**

### 3.5 DE-ICING SYSTEM RETURN(S) ON SEA BOX AND STRAINER INLET

This type of circulation system provides another viable solution to ice obstructed sea inlets. This system has a recirculation line with isolating valves that must be fitted only when the ship is in dry-dock. A new valve must be installed on the sea box.

#### 3.5.1 THE SEA INLET BOXES

- a) should be fitted on each side of the ship;
- b) should be fitted with a low steam pressure connection to clear sea strainer; and
- c) should be vented to atmosphere by a valved pipe with a cross-sectional area specified by a classification society.

Diversion valves and piping should be provided at overboard cooling water discharges to permit heated water to return to sea inlet boxes so as to prevent ice blockage.

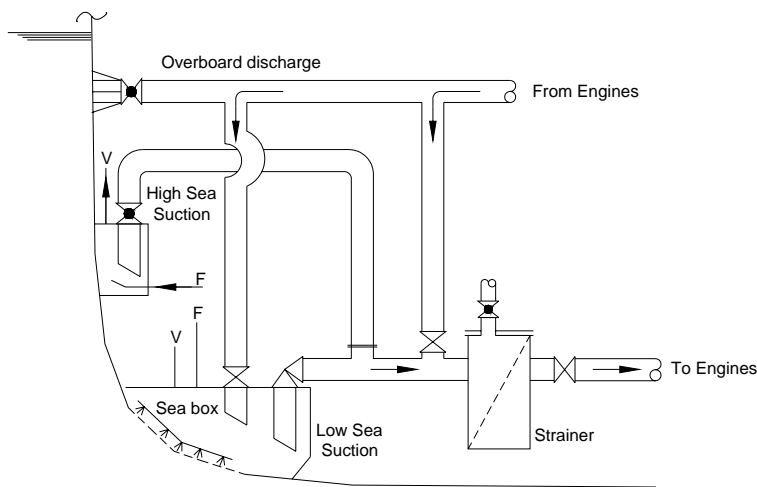

- Recirculation line with isolating valves
- Proportional reduction in sectional area may be suitable considering colder water
- Keep incoming water to sea strainer above 20° C
- High sea suction closed
- Low sea suction may need to be throttled
- Overboard discharge near shut to ascertain positive recirculation

**Figure 3.5 : De-icing returns on sea box and at strainer inlet – Section view**

### 3.6 DE-ICING SYSTEM RETURN AT STRAINER INLET

This circulation system, Figure 3.6, can be an effective method in clearing a sea strainer blocked by ice. With this system, a recirculation line with isolating valves can be arranged at any time, if space between sea box and strainer is sufficient.

#### 3.6.1 THE SEA INLET BOXES

- should be fitted on each side of the ship;
- should be fitted with a low steam pressure connection to clear seawater strainer; and
- should be vented to atmosphere by a valved pipe with a cross-sectional area specified by a classification society.

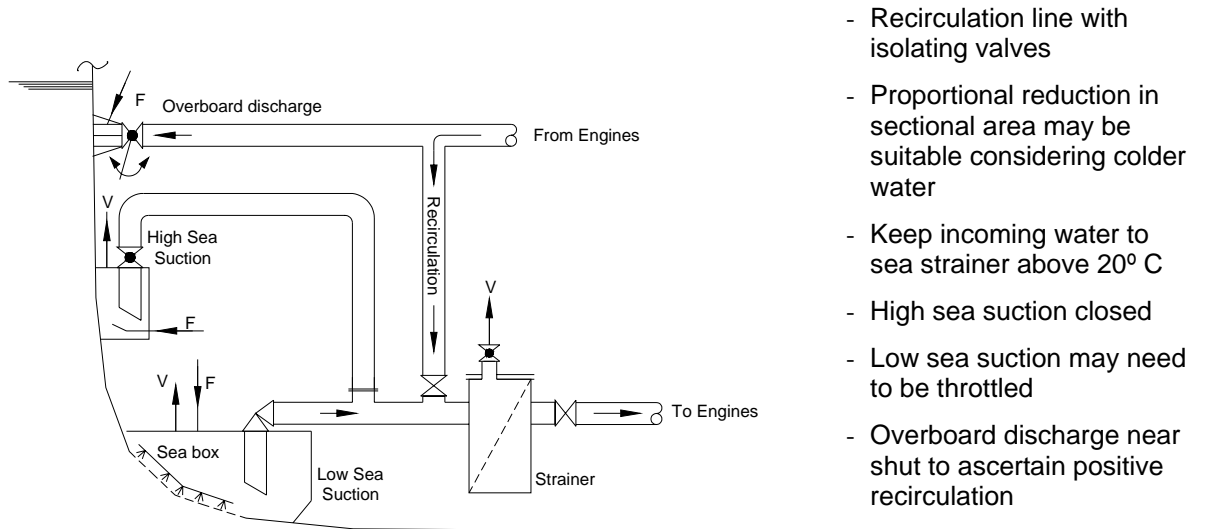

**Figure 3.6 : De-icing design return at strainer inlet – Section view**

### 3.7 TROUBLESHOOTING SEA INLETS PLUGGED BY ICE

- a) Reducing the amount of new seawater in the cooling system is the best way to avoid slush and ice in the strainers. A lower capacity seawater pump may be used instead of the main seawater pump. Flow rate could be reduced by throttling the seawater pump discharge valve. Along with this provision, flow could be reduced to generators, compressors, shaft line bearings and miscellaneous coolers. Some ships have direct steam injection in sea boxes, which aids in melting ice. For other ships, it is often possible to install a flexible hose to achieve the same effect. Experience shows, that application of steam alone is not sufficient even in light ice condition; it is only a part of a series of countermeasures to reduce difficulties, particularly when the ship is laid up or alongside.
- b) It is advisable to use only one sea box at a time. Monitoring seawater pressure at the inlet, proved to be the best indication of ice presence in the circuit. Fluctuations and eventually an important pressure drop, will indicate that it is time to clean the strainer. This operation is somewhat risky and must be carried out with great caution. Engine-room personnel must use alternate sea boxes and isolate the one about to be cleaned. Take care that inlet and outlet valves are completely shut and tight before removing the strainer cover. It can be possible that ice remains on the inlet and outlet valve seats. In this case, repeat opening and closing of valves until ice clears out. After opening the strainers, open the sea inlet valve slightly to flush out any remaining ice. (A large quantity of ice and water can easily accumulate in engine-room bilges). Following this operation, replace the strainer cover. It may be necessary to repeat this operation numerous times. To reduce downtime at each strainer, equip each location with the necessary tools and accessories.
- c) Sometimes ballast water could be stored and used on a temporary basis for cooling or back flushing. Usually a ballast system will allow interconnection with seawater cooling either by gravity or otherwise, through use of the after peak or wing ballast tanks. From double bottom tanks, a ballast pump is to be used. In both situations, regular sea suction valves must be closed, to avoid loss of water. A careful study of cooling water and ballast diagrams should reveal various options. Some examples are Figures 3.8A and 3.8B.

#### 3.7.1 REVIEW

- a) Make sure all seawater cooling valves operate freely.
- b) Use one seawater strainer at a time, to avoid the possibility of ice blockage in both strainers at the same time.
- c) Reduce heated water flow overboard, by closing the overboard discharge valve as much as possible, thereby, reducing the cleaning frequency of seawater strainers. (Use an auxiliary seawater pump or throttle close the discharge valve of the seawater pump).
- d) Prioritize use of low seawater suction, which is located well below the water level.
- e) Prepare a chain block and hang it above each strainer cover. Keep necessary tools and accessories on hand to minimize cleaning time for strainers. Free all cover nuts and test cocks.

- f) **Do not use a seawater strainer without its perforated plate inside. This plate serves as a filter effectively resisting flow of large chunks of ice into the seawater circulating system that could block-up coolers and lead to total blockage of the cooling system.**
- g) The seawater inlet valve can be partially stuck open due to ice accumulation.
- h) Examine bilge injection valve for free operation in case of a problem while cleaning strainers. Do not pump accumulated oily-bilge water overboard. It could be pumped into a ballast tank for temporary storage and then cleaned out at the next port of call.
- i) Advise the bridge when cleaning seawater strainers.

### 3.7.2 *CLEANING PROCEDURE*

- a) Open up either the high or low seawater suction valve that is free of ice.
- b) Close the inlet and outlet valves of the seawater strainer that is blocked with slush and ice.
- c) Open the vent valve on the seawater strainer to ensure that the inlet and outlet valves are shut and tight.
- d) Remove strainer cover nuts.
- e) Remove cover with chain block.
- f) Remove and clean strainer.
- g) Flush ice accumulated in piping and strainer basket by slightly opening the sea inlet valve.
- h) Reinstall strainer and cover. Sea suction is now ready for reuse, when needed.



**Figures 3.7A – Frazil ice accumulation at the bottom of engine-room bilges after numerous seawater strainer cleaning**



**Figures 3.7B – Frazil ice accumulation in bilges due to strainer cleaning**

### 3.8 DE-ICING DESIGN USING BALLAST TANK

Ballast water can be used as an emergency source for cooling in two ways :

- a) As per Figure 3.8A, water is drawn from a ballast tank by ballast pump and pushed through the regular engine cooling system. With proper valve manipulation, temporary back flushing of sea strainers, one by one, is possible. Special attention should be taken to avoid using large amounts of water. A main seawater pump rotating backwards is an indication of clear water passage. Return to normal cooling system and slowly re-fill ballast tank so as not to deprive cooling system of seawater.
- b) As per Figure 3.8B, water is drawn from one tank and returned to the same by using a ballast pump. It should be noted that, while this solution is effective, it is usually a short-term solution unless large quantities of ballast water is available or a double bottom tank is used. Otherwise, consider a combination of back-flushing sea strainers as stated above and partial recirculation to sea box.

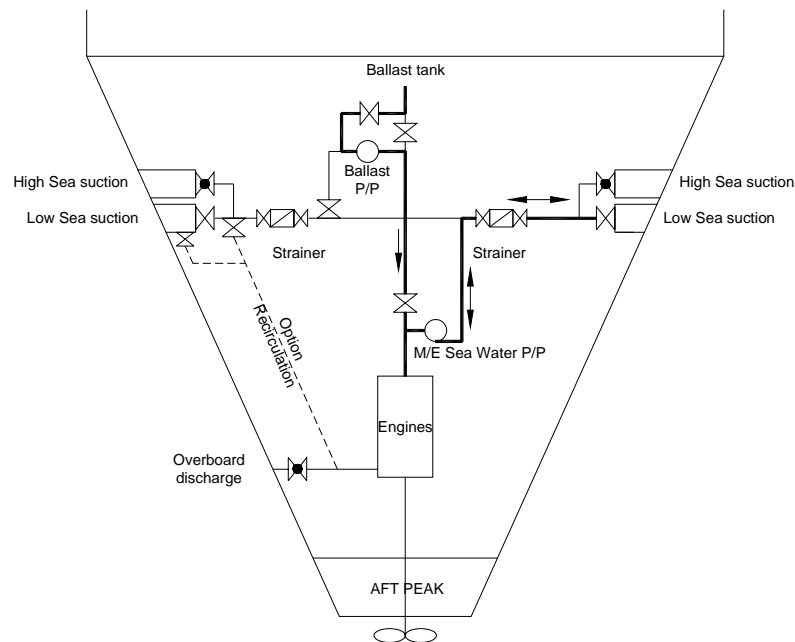

- Recirculation line with isolating valves
- Proportional reduction in sectional area may be suitable considering colder water
- Keep incoming water to sea strainer above 20° C
- High sea suction closed
- Low sea suction may need to be throttled
- Overboard discharge near shut to ascertain positive recirculation

**Figure 3.8A : De-icing design using ballast tank – Plan View**



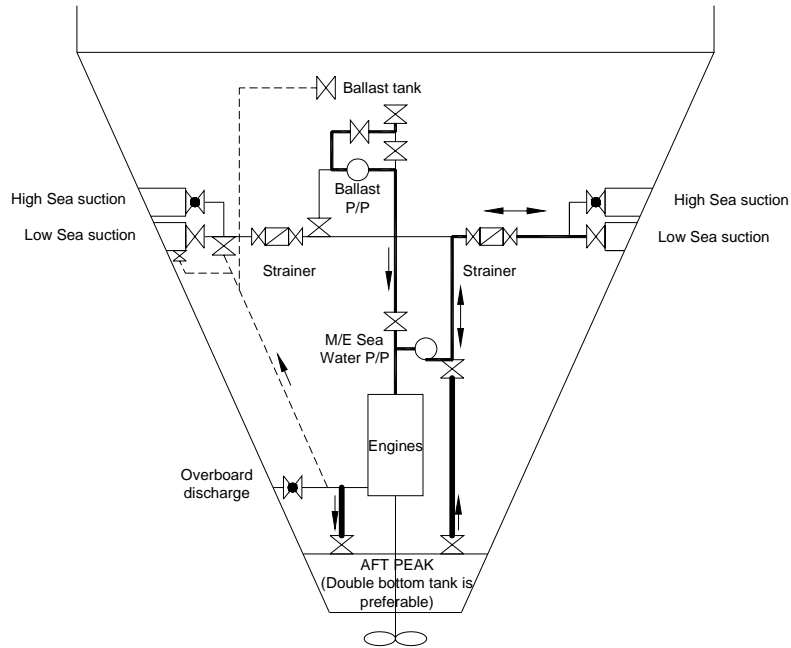

- Recirculation line with isolating valves
- Proportional reduction in sectional area may be suitable considering colder water
- Keep incoming water to sea strainer above 20° C
- High sea suction closed
- Low sea suction may need to be throttled
- Overboard discharge near shut to ascertain positive recirculation

**Figure 3.8B : De-icing design using ballast tank – Plan view**

### 3.9 EMERGENCY DE-ICING SYSTEM ARRANGEMENT

There are two emergency installation possibilities :

- a) Weld a valved connection on the sea box air vent, where pipe size is sufficient as indicated in Figure 3.9A; or
- b) Weld a valved connection on a new strainer cover. Do not weld on the existing cover, it is probably made of cast iron and will turn brittle after welding and could eventually cause engine-room flooding. Refer to Figure 3.9B.

As a temporary solution, run a flexible hose<sup>5</sup> of suitable size, between the overboard discharge to the cover of the strainer or to the air vent. Recirculate heated water in order to maintain seawater temperature between 20° C to 30° C.

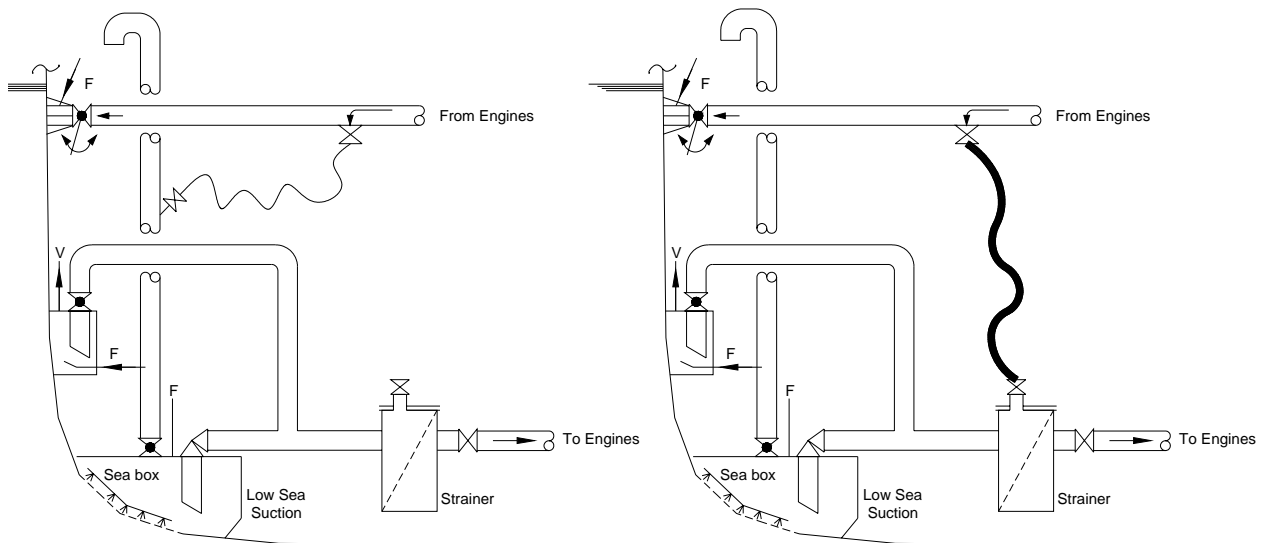

- Recirculation line with isolating valves
- Proportional reduction in sectional area may be suitable considering colder water
- Keep incoming water to sea strainer above 20° C
- High sea suction closed
- Low sea suction may need to be throttled
- Overboard discharge near shut to ascertain positive recirculation

**Figure 3.9A : Emergency sea inlet arrangement – Section view**

**Figure 3.9B : Emergency sea inlet arrangement – Section view**

<sup>5</sup> A minimum internal diameter should be at least 75 mm for a propulsion plant of 10,000 kW or less and 100 mm for a propulsion plant over 10,000 kW. A suitable flexible hose would require to withstand vacuum, high temperatures and a minimum pressure of 10 bar.

## 4. DECK EQUIPMENT

### 4.1 DECK LINE

- a) Isolate and drain seawater and freshwater lines on deck to prevent freezing.
- b) Fire main drain status “open or close” to be posted in the ship’s office, wheelhouse, and engine control room.
- c) Post caution notices at local and remote starting points of various pumps whose lines have drain valves open.
- d) Install rubber hoses in exposed deck scupper pipes.
- e) Freshwater tanks heating to be on (where fitted).

### 4.2 FIRE LINE

Prior to arrival in a cold weather area, the fire line must be drained completely. After the draining, all exposed valves must be left cracked open because under cold weather conditions, the frozen moisture between seat, flap and stem may render valve opening impossible (lubricate stems). Refer to section 4.3.

Some fire line configurations will need additional drain valves fitted at the lowest point, where water could be completely drained.

Using fire lines in below freezing temperatures requires a constant flow of water through all exposed lines and branches. This is achieved by opening end valves slightly, leading water overboard through hoses.

After using the fire line, a quick draining of the line is necessary. To achieve quick draining (less than 10 minutes), the lowest valve on the main deck should be fully opened as well as upper exposed valves on the line (bridge deck and forecastle). The airflow in the line from the upper valve(s) will accelerate the line’s drainage due to venting action.

After draining the line, all exposed valves must be left cracked opened except the valve for washing anchors, so as to avoid ice accumulation in the anchor hawse pipe (see Figure 4.2) and inadvertent pressure loss if a fire should occur. Secure shut isolating valves in forecastle.

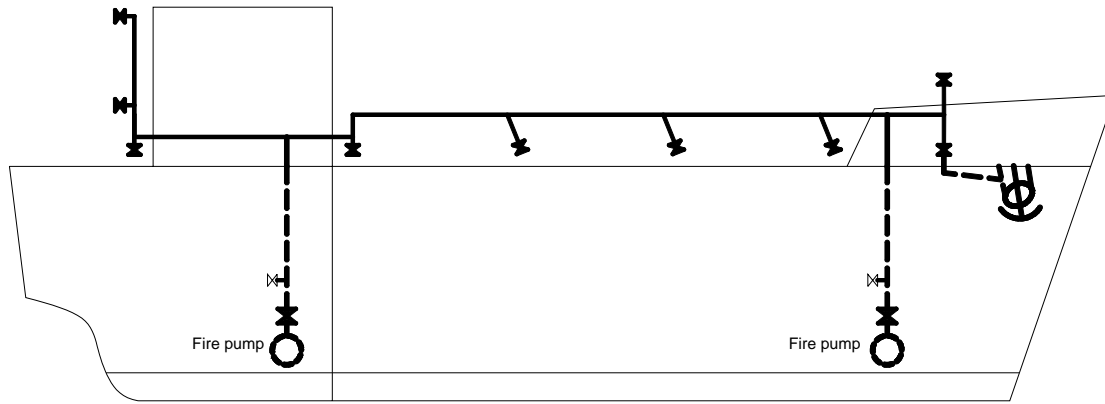

**Figure 4.2 – Fire Line**

### 4.3 DECK EQUIPMENT

Cargo cranes are vulnerable under cold temperatures. Sluggish hydraulic control and slippery brakes are very common. Failure to overcome these difficulties has led to fatal accidents in the past. In order to overcome these problems, cranes should be warmed up and all safety switches tested, well in advance. Motor, pump and hydraulic oil heaters must be kept on, as cold conditions persist.

- a) All exposed electric and air motors of the following equipment is to be securely protected with canvas covers : accommodation ladders, provision cranes, bunker davits, electric whistle motor on the foremast and forward and aft winch starting switch boxes.
- b) Start motors and pumps of gangways, provision cranes, pilot doors and bow thruster well in advance of their use. If practicable, keep them running continuously, otherwise, perform idling runs at a suitable frequency, decided under prevailing conditions. The pilot doors' trace-heating (where fitted) to be kept on at all times during the winter season. The «pilot reels» power to be always kept on so that space heaters remain on. Check the oil level in the pilot doors' storage tanks.
- c) Pilot ladder, if lowered too early, will gather ice and become slippery and dangerous.
- d) Start the windlass/mooring winches motors and pumps well in advance. In severe cold conditions, turn on hydraulic tank heaters, and if practicable, keep the pumps running and keep the winches turning at slow speed, otherwise, perform 30-minute idling runs every 5 to 6 hours. Duration and frequency, is to be carefully decided under prevailing conditions. Also, check the oil level in the hydraulic tanks for the forward and aft

winch before putting into use. A thermostat should control the hydraulic tank heaters automatically.

- e) Ensure all mooring-ropes on the drums are kept securely covered with strong canvas covers.
- f) Windlass, compression-bar on the bow-stoppers, mooring-winch, cargo-winch, open gears, engaging clutches, pins, operating handles, brake clamping bolt threads - all to be liberally covered with grease. All nipple points to be greased up.
- g) All loose lashing material on deck to be stowed away in bins and stowage racks, as far as practicable.
- h) All lashing material in use (turn-buckles, shackles etc.) to be liberally greased.
- i) Do not use manila ropes for any lashings on deck, as it becomes stiff and impossible to handle. Polypropylene and some other synthetic ropes are best suited for severe temperature use.
- j) All exposed movable parts (butterfly nuts/bolts, flap hinges, vents, valve spindles, sounding pipe covers, hydrant wheel spindles, steel door dogs, etc.) to be kept liberally covered with grease. Some antifreeze mixed into the grease is very effective.
- k) Pilot doors' wheels and rams, pilot ladder rollers and track ways to be well greased.
- l) Regularly clear decks and walkways between hatches, of snow and ice.
- m) Keep shovels, crow bars, hammers, spikes, sledge hammers, pickaxes (fire-axes will suffice), grease-pot, blow-lamp and sufficient salt, handy and in convenient sheltered locations near work areas.
- n) When receiving freshwater alongside, water is to be left running continuously. Ensure that the end of the hose is pushed well down inside the freshwater tank filling pipe to prevent freezing.
- o) Ensure heating (where fitted), are kept in operation in storage room.
- p) Hold bilges, store bilges, chain lockers and the bilges for the side passage ways to be stripped dry.
- q) Use heaving line (rubber hose) or environmentally safe antifreeze in sounding pipes in order to prevent bursting of pipes.

#### **4.4 CHEMICAL TANKERS**

For chemical tankers, decontamination showers and eyewash stations should be operable in all ambient conditions (IBC 14.2.10).

##### **4.4.1 POSSIBLE SOLUTIONS IN COLD WEATHER**

- a) Install a heating water tank and recirculation pump in accommodation or on exposed deck and have water circulating continuously through the lines to avoid freezing.

- b) Have a trace-heating system on lines insulated from cold. Care should be taken that thermostats are working and have enough power to run through cables to provide effective trace-heating.

## 5. FREEZING SPRAY

### 5.1 SHIPBOARD ICE ACCRETION

The danger posed by formation, or accretion, of ice on exposed ship's structures and equipment is not always fully appreciated. Serious ice accretion adversely affects several areas of a ship's operation and safety such as : stability, strength, equipment, securing and closing arrangements. As a result of previous occurrences involving the icing of ships in Canadian waters, Transport Canada Marine Safety published a Ship Safety Bulletin (03/1991) to serve as a reminder of some of the problems which may be encountered when operating in winter conditions on the east coast of Canada.

#### 5.1.1 SHIP SAFETY BULLETIN

**Subject : Icing of ships**  
**Bulletin No.:** 03/1991  
**Date (Y-M-D) :** 1991-02-14



The purpose of this Ship Safety Bulletin is to draw the attention of all mariners to icing incidents of ships navigating in Canadian waters, the possible consequences thereof and the preventive measures that are available.

Ships with containers stacked on the forward end and tankers are particularly vulnerable to ice accretion on the forecastle deck structure and adjacent areas. Large quantities of ice accumulation may develop and remain unnoticed even during daylight hours, since observation of that part of the ship from the bridge is obstructed.

A very severe case has been documented recently. A 120m vessel left a European port with a 0.2m trim by the stern and reached the Quebec City port with a trim by the bow of approximately 4.0m.

A heel of five degrees developed and the vessel also became directionally unstable. The master was totally unaware of the serious icing forward until a boarding pilot reported the developing condition.

The Canadian Coast Guard publishes a document entitled "ICE NAVIGATION IN CANADIAN WATERS" TP 5064 \* which is available to all mariners. This publication addresses the type of weather conditions which produce ice accretion and also lists radio information frequencies for the various regions of the River and Gulf of St. Lawrence as well as other useful information pertaining to ice navigation and icebreaker assistance. It is a **Canadian Regulatory Requirement** that mariners avail themselves of this publication for their guidance and protection of the ship, crew and the environment.

*This document may be obtained from the Canadian Government Publishing Centre, Supply and Services Canada, Ottawa, Ontario, K1A 0S9 for \$14.75.*



[http://www.tc.gc.ca/marinesafety/bulletins/1991/03\\_e.htm](http://www.tc.gc.ca/marinesafety/bulletins/1991/03_e.htm)

## **5.2 ANCHORS**

Vessels likely to encounter freezing spray conditions at sea must have means of clearing ice from anchor hawse pipes and windlasses before arriving in restricted waters.

When approaching a freezing spray area, it is good practice to leave anchors slightly lowered (approx. 0.5 meter) in the hawse pipe in order to pull them free of ice accretion when needed. Depending on sea conditions, care should be taken to avoid hull damage. It is also advisable, to maintain securing claws in place because of slippery brakes taking into account, that the anchors must always be able to be readily released in case of blackout.

## **5.3 RISKS AND CONSEQUENCES**

Icing of ships, especially containers and their securing arrangements may require de-icing. This could delay off-loading operations. Ice accretion on hatch covers require considerable clearing-up operations (view the following photos). These procedures are not only time consuming but, it could result in mechanical damage if carried out without care. Clearing-up operations should therefore, always be followed by careful inspection.



**Figures 5.3A– Severe case of ice accretion in bow area**



**Figures 5.3B – Main deck entirely blanketed with ice**



**Figures 5.3C– Midship main deck iced over**



**Figures 5.3D – Access to forecastle and forward liferaft severely hampered by presence of ice**



**Figures 5.3E– Inboard view of vessel – Entire structure hidden underneath ice**



**Figures 5.3F– Deck, piping and valves inaccessible**



**Figures 5.3G– Forward mast area guy wires draped in ice**



**Figures 5.3H– Restricted visibility on forward mast area**





**Figures 5.3I– Guy wire view after de-icing**



**Figures 5.3J– Safe access to tanker bow fully obstructed by ice**



**Figures 5.3K– The “Catwalk”**



**Figures 5.3L– Ship tied up alongside – Railings are walls of ice and decks covered in snow and ice**



**Figures 5.3M– Effect of freezing spray on a container ship**



## 6. ICE NAVIGATION

Non-ice strengthened vessels now frequently trade to areas which several years ago were closed to normal navigation during winter months.

This is a direct result of several factors :

- a) improved icebreaker assistance;
- b) improved ice observation; and
- c) an improved advisory service in programming vessels through ice-affected areas.

These factors have substantially reduced the risk of ice damage, provided that the master acts in accordance with sound operating practice in relation to : speed in ice conditions; manoeuvring; ice escort procedures; ice type reports (drift ice, pack ice, consolidated pack ice) and following recommended ice navigation routes.

The master must consult these relevant publications : « *TP 5064 - Ice Navigation in Canadian Waters* », « *Sailing Directions* », « *Mariner's Handbook* » or equivalent, prior to entering areas where ice may be encountered, in order to be fully briefed about existing dangers, and how best to deal with them.

The above mentioned publications give sufficient information for safe navigation, if closely followed.

In port, during periods of heavy ice, it is preferable to moor the vessel so that the bow stems the heaviest of ice flow.

### 6.1 POSSIBLE HULL DAMAGE

At temperatures below freezing point, the impact resistance of steel is reduced. Hard contacts with ice, docks and fenders may result in structural failure at a significantly lower level of impact. A close examination of contact areas is strongly recommended.

Immediately upon clearing heavy ice, or areas where cold weather procedures are in force, an inspection should be made of all accessible cargo compartments, void spaces, forepeaks, forward deep tanks, cofferdams and pump rooms to verify the integrity of the hull.

## 7. LIFESAVING APPLIANCES

Ice accretion should be regularly removed from lifeboats and launching equipment to ensure ease of launching where required. An ice removal mallet should be available in the vicinity of lifeboat and liferafts.

### 7.1 LIFEBOAT AND SURVIVAL CRAFT

An uncovered survival craft, as well as the access ladder, should be protected from snow or rain with an appropriate tarp. Avoid material made from natural fibers for painters, embarkation ladders, ropes and protective tarps since natural fibers absorb moisture resulting in a loss of flexibility and durability under cold weather conditions.

### 7.2 LIFEBOAT PROPULSION

The *International Life-Saving Appliance Code (LSA)* stipulates :

Section 4.4.6.1 “(...) No engine should be used for any lifeboat if fuel oil has a flash point of 43° C or less (closed-cup test).”

Section 4.4.6.2 “(...) The engine starting systems and starting aids should be able to start the engine at an ambient temperature of –15° C within two minutes of commencing the start procedure (...)”

#### 7.2.1 FUEL OIL

Ignition quality of marine diesel fuel oils is of major importance for diesel engine starting time in cold conditions. Fuel oils with higher cetane numbers have better ignition qualities. Refer to table 7.2.

The diesel oil cloud point characteristic, is to be in accordance with temperature, related to section 4.4.6.2 of *LSA Code* to avoid blockage of the fuel filter and fuel line by wax.

Instruction on acceptable ignition quality should be obtained from the lifeboat engine manufacturer’s manual.

Oil companies have commercialized winter grade products that have many desirable characteristics for starting engines in cold conditions.

			D40	D25
Density	Kg/l	MAX	.8350	.8750
Flash point	° C		45	45
Viscosity at 40° C	CST	MIN	1.3	1.9 (1+3)
Cetane ASTM		MIN	43	43
Cloud point	° C	MAX	-36/-39	-
Jan. Feb. 16 to 30 Nov. Dec.			-	-24
1 to 15 Nov.			-	-20
Sulfur	PPM	MAX	475	475

**Table 7.2 – Winter Fuel Oil Characteristics**

When refueling with the appropriate diesel fuel oil, allow sufficient space in the tank to allow diesel fuel oil to expand. If the diesel fuel oil tank was filled to it's maximum in cold temperatures, it may overflow in warmer temperatures.

### 7.2.2 LUBRICATING OIL

Regular engine oil should be replaced by a multi-grade oil such as 5W30 or a more appropriate winter grade type.

Today, synthetic oils reduce friction between all movable parts of a diesel engine and offer more linear viscosity characteristics. A synthetic oil can achieve much easier starting than multi-grade oil, especially in cold weather.

Instruction on proper viscosity for lubricating oil should be obtained from the lifeboat engine manufacturer's manual.

### 7.2.3 ELECTRIC HEATER

The lifeboat engine electric heater should be in function. A temporary heater (portable electric heater or protected light) can be installed under or on the side of the engine with a fire resistant blanket over it to preserve heat. An approved electrical appliance to avoid electric shock or fire hazard is to be utilized. Electrical cables running through openings such as access doors and windows are not acceptable.

#### **7.2.4 WATER COOLED ENGINE**

The antifreeze mixture should sustain weather of at least  $-35^{\circ}\text{C}$  to avoid damage to the cylinder block. Record temperatures back in 2003 were recorded in Port-Alfred, Québec at  $-40^{\circ}\text{C}$  for four consecutive days.

#### **7.3 DAVITS**

Every pulley, drum, and cable where water can infiltrate, should be greased to eliminate water and to protect against frozen water, which may damage or harm the movement of such equipment.

Emulsified oil from the davit gearbox may solidify under cold conditions. This contaminated oil is to be renewed. Investigate the cause of contamination and then take corrective action. Excessive moisture in the gearbox may lead to braking system failure.

#### **7.4 LIFERAFTS**

Liferafts have to be protected from snow, rain and ice accretion with an appropriate protective tarp as well as for embarkation ladders. Avoid material made from natural fibers for painters, embarkation ladders, ropes or protective tarps since natural fibers absorb moisture and lose their flexibility and durability under cold weather conditions.

## 8. LIVING QUARTERS

### 8.1 ACCOMMODATION

- a) Steam heating to accommodation is to be 'ON'. Steam is to be the primary heating system, backed up by individual cabin heaters (where fitted). This helps to cocoon the accommodation spaces from the cold and prevents freshwater pipes from freezing. If the ship is not insulated and provided with a vapour shield, **introduction of moisture in the air should be avoided for cold climates** as vapour will condense between walls and ceilings causing a fire hazard around electrical circuits.
- b) It is advisable to cover portholes and window cavities with polyethylene or Perspex, so as to provide an air buffer insulation (where not double glazed or heated). This is a good contribution towards reducing ice formation on interior surfaces.
- c) Ensure all double doors to accommodation, doors to stores, passageways and holds are kept shut at all times. Keep accommodation spaces in a state of light pressurisation. Recirculate air, taking care of all of the above.
- d) All steps, decks, walkways and passages into and around accommodation to be kept clear of accumulated snow and ice by regular shovelling and salting. Coarse salt to be liberally dispersed on deck walkways, gangways and ladder steps to prevent slipping accidents. A sufficient stock of de-icing salt should be kept on board and readily available for this purpose.

### 8.2 CREW PROTECTION

- a) All shipboard personnel are to be instructed in the hazards of working in exposed locations and instructed in the type and amount of minimum clothing to be worn.
- b) Several layers of clothing (instead of one heavy suit) are preferable as air trapped between layers of clothing, provides a greater insulation and consequently, a reduction in loss of body heat. Wear mittens (not gloves), wind-proof and water resistant many-layered clothing and two pairs of socks (cotton next to skin, then wool).
- c) Use of clothing with some ventilation decreases perspiration, which can freeze. Wet flesh freezes faster than dry flesh.
- d) While working, it is natural to perspire. Do not remove clothing while in an exposed environment. Go into the accommodation to dry off.
- e) As far as practicable, work with back towards the wind.
- f) Gloves to be sufficiently loose for circulation to be maintained.
- g) Hoods and caps to be worn with ears fully covered. Much of body heat is lost through an unprotected head and neck.
- h) Never rub a numb area as this could damage frozen flesh. Suspected frozen flesh is to be warmed-up gradually and not immersed in hot water. Immersing immediately in hot water may cause permanent damage to skin and body tissues.

- i) In extreme temperatures, feel your cheeks and nose with your fingers for sensation. Hands face, ears and feet are areas particularly susceptible to localized freezing. No sensation means a likelihood of frostbite. Enter a warm area immediately. When working in groups, keep an eye on each other to look for any numbness or whiteness (frostbite occurs when skin tissue starts to freeze).
- j) When going into sub-zero temperatures, be aware that the wind chill factor increases the effect of colder temperatures, therefore frostbite can occur faster.
- k) Frost-bite and hypothermia are very real dangers associated with cold weather. Guard carefully against them. Never work alone in extreme cold temperatures.
- l) Note, clothes by themselves do not warm the body. The body is actually warmed-up by its own heat generation and the body heat in turn warms the layers of air trapped between the skin and the clothing.
- m) Shivering is the first sign that the body is trying to combat cold by generating more heat. However, if the exposure is severe, the body is unable to conserve or generate enough heat to maintain body core temperature. Shivering will stop, unconsciousness follows and than death due to cold exposure or hypothermia. Carry out "Active Warming or Passive Warming". If nothing is readily available, apply body-to-body heat to preserve life.

ALL CREW AND OFFICERS ARE TO CAREFULLY READ AND UNDERSTAND THE ABOVE PRECAUTIONS AND ARE TO FAMILARIZE AND COMPLY WITH ALL IMPORTANT COLD WEATHER SURVIVAL TECHNIQUES.

## Wind Chill

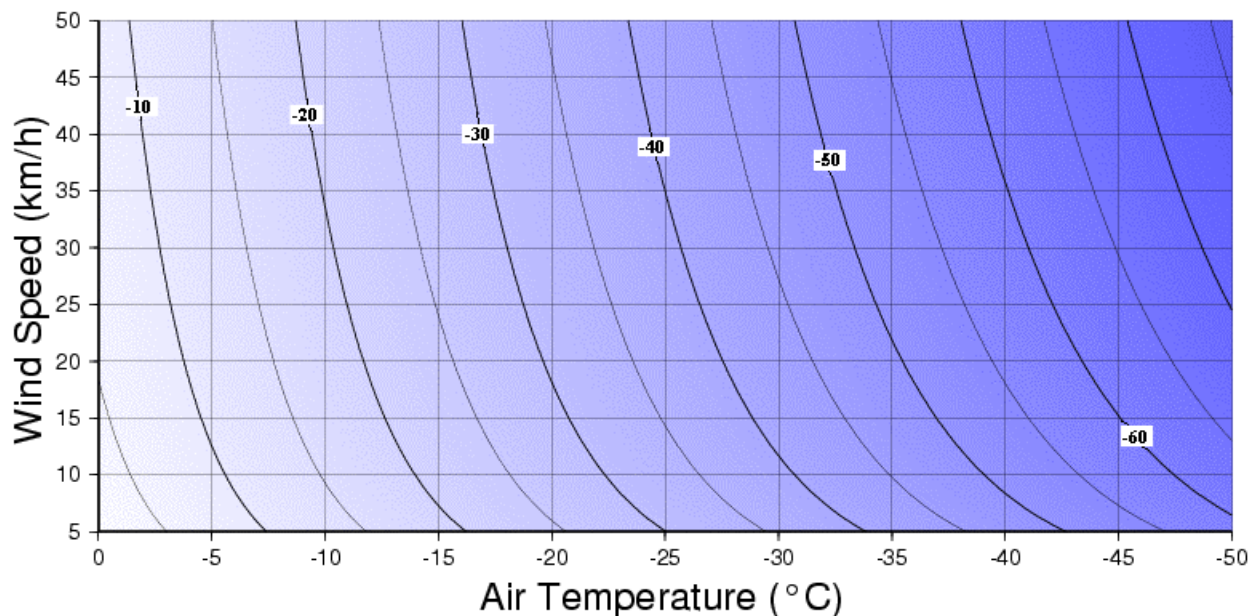

## Wind Chill Calculation Chart

where  $T_{\text{air}}$  = Air temperature in °C and  $V_{10}$  = Observed wind speed at 10m elevation, in km/h.

$T_{\text{air}}$	5	0	-5	-10	-15	-20	-25	-30	-35	-40	-45	-50
$V_{10}$												
5	4	-2	-7	-13	-19	-24	-30	-36	-41	-47	-53	-58
10	3	-3	-9	-15	-21	-27	-33	-39	-45	-51	-57	-63
15	2	-4	-11	-17	-23	-29	-35	-41	-48	-54	-60	-66
20	1	-5	-12	-18	-24	-30	-37	-43	-49	-56	-62	-68
25	1	-6	-12	-19	-25	-32	-38	-44	-51	-57	-64	-70
30	0	-6	-13	-20	-26	-33	-39	-46	-52	-59	-65	-72
35	0	-7	-14	-20	-27	-33	-40	-47	-53	-60	-66	-73
40	-1	-7	-14	-21	-27	-34	-41	-48	-54	-61	-68	-74
45	-1	-8	-15	-21	-28	-35	-42	-48	-55	-62	-69	-75
50	-1	-8	-15	-22	-29	-35	-42	-49	-56	-63	-69	-76
55	-2	-8	-15	-22	-29	-36	-43	-50	-57	-63	-70	-77
60	-2	-9	-16	-23	-30	-36	-43	-50	-57	-64	-71	-78
65	-2	-9	-16	-23	-30	-37	-44	-51	-58	-65	-72	-79
70	-2	-9	-16	-23	-30	-37	-44	-51	-58	-65	-72	-80
75	-3	-10	-17	-24	-31	-38	-45	-52	-59	-66	-73	-80
80	-3	-10	-17	-24	-31	-38	-45	-52	-60	-67	-74	-81

<b>FROSTBITE GUIDE</b>
Low risk of frostbite for most people
Increasing risk of frostbite for most people in 10 to 30 minutes of exposure
High risk for most people in 5 to 10 minutes of exposure
High risk for most people in 2 to 5 minutes of exposure
<b>High risk for most people in 2 minutes of exposure or less</b>

## Wind chill - Minutes to Frostbite

The following are approximate values.

Temperature (° C) Wind (km/h)	-15	-20	-25	-30	-35	-40	-45	-50
10	*	*	22	15	10	8	7	2
20	*	30	14	10	5	4	3	2
30	*	18	11	8	5	2	2	1
40	42	14	9	5	5	2	2	1
50	27	12	8	5	2	2	2	1
60	22	10	7	5	2	2	2	1
70	18	9	5	4	2	2	2	1
80	16	8	5	4	2	2	2	1

\* = Frostbite unlikely

The wind speed, in km/h, is at the standard anemometer height of 10 metres (as reported in weather observations).

Legend :

Frostbite possible in 2 minutes or less

2

Frostbite possible in 3 to 5 minutes

5

Frostbite possible in 6 to 10 minutes

10



## Wind Chill Hazards

Check the wind chill before you go outdoors in the winter, and make sure you are well prepared for the weather. Even moderate wind chill values can be dangerous if you are outside for long periods.

**Note :** The guidelines on frostbite, in the table below, apply to healthy adults.

Wind Chill Hazards and Risk of Frostbite			
Wind Chill	Risk of frostbite	Health Concern	What to do
0 to -9	Low	– Slight increase in discomfort	– Dress warmly, with the outside temperature in mind.
-10 to -27	Low	– Uncomfortable – Risk of hypothermia if outside for long periods without adequate protection	– Dress in layers of warm clothing, with an outer layer that is wind-resistant. – Wear a hat, mittens and scarf. – Keep active.
-28 to -39	Increasing risk : exposed skin can freeze in 10 to 30 minutes	– Check face and extremities (fingers, toes, ears and nose) for numbness or whiteness – Risk of hypothermia if outside for long periods without adequate protection	– Dress in layers of warm clothing, with an outer layer that is wind-resistant. – Cover exposed skin : wear a hat, mittens and a scarf, neck tube or face mask. – Keep active.
-40 to -47	High risk : exposed skin can freeze in 5 to 10 minutes*	– Check face and extremities (fingers, toes, ears and nose) for numbness or whiteness (frostbite) – Risk of hypothermia if outside for long periods without adequate protection	– Dress in layers of warm clothing, with an outer layer that is wind-resistant. – Cover all exposed skin: wear a hat, mittens and a scarf, neck tube or face mask. – Keep active.
WARNING LEVEL** -48 to -54	High risk: exposed skin can freeze in 2 to 5 minutes*	– Check face and extremities frequently for numbness or whiteness (frostbite) – Serious risk of hypothermia if outside for long periods	– Be careful. Dress very warmly in layers of clothing, with an outer layer that is wind-resistant. – Cover all exposed skin: wear a hat, mittens and a scarf, neck tube or face mask. – Be ready to cut short or cancel outdoor activities. – Keep active.
-55 and colder	High risk: exposed skin can freeze in less than 2 minutes	DANGER! – Outdoor conditions are hazardous	– Stay indoors.

\* In sustained winds over 50 km/h, frostbite can occur faster than indicated.

\*\* In parts of the country with a milder climate (such as southern Ontario and the Atlantic provinces except Labrador), a wind chill warning is issued at about -35° C. Further north, people have grown more accustomed to the cold, and have adapted to the more severe conditions. Because of this, Environment Canada issues warnings at progressively colder wind chill values as you move north. Most of Canada hears a warning at about -45° C. Residents of the Arctic, northern Manitoba and northern Quebec are warned at about -50° C, and those of the high Arctic, at about -55° C.

## Canadian Wind Chill Records

Canadians cope with a wide variety of wind chills. The Arctic is the wind chill capital of the country, while the mildest conditions are found in Vancouver and Victoria. The chart shows the highest recorded wind chill (over a 30-year period) for each site.

<b>Highest recorded wind chill (over a 30-year period)</b>				
<b>City</b>	<b>Date</b>	<b>Wind Chill</b>	<b>Wind Speed (km/h)</b>	<b>Temperature (°C)</b>
Quebec City	Feb. 12, 1967	-52	43	-33.3
Montreal	Jan. 23, 1976	-49	45	-30.6
Halifax	Feb. 13, 1967	-41	48	-24.4
Charlottetown	Jan. 18, 1982	-50	37	-32.4

## 9. NAVIGATION BRIDGE

All ships should be fitted with a suitable means to de-ice sufficient conning position windows to provide unimpaired forward and astern vision.

Humidity in the air from the heating system should be avoided in order to prevent window fogging and icing.

The windows referred to above, should be fitted with an efficient means of clearing melted ice, freezing rain, snow mist and sea spray from the outside and accumulated condensation from the inside. A mechanical means to clear moisture from the outside face of a window should have operating mechanisms protected from freezing or ice accumulation that could impair effective operation.

- a) Ensure individual heating to bridge windows remain on at all times (where fitted), when temperatures are below freezing. Drastic changes in temperatures created by a chill factor, may cause the glass to crack, due to thermal shock.

*Note : if the above arrangement is not available, installation of transparent heat shrink film over each window, will reduce heat loss and prevent frost and condensation.*

*Another method consists of forced ventilation, aimed at each window, using portable fans or improvised ducting made of polyethylene fed from ship's heating system.*

*Handheld ice scrappers and lint free paper towels are a must in many cases.*

- b) Individual heaters in the wheelhouse to be kept on during winter (where fitted). If not fitted, at least two portable heaters (5000 watts each, with ventilator) should be safely and adequately installed, temporarily.
- c) Every effort shall be taken to prevent exterior windows from ice accretion.
- d) Drain the bridge window washwater line and leave drains open or use -45° C antifreeze window wash.
- e) Ensure whistle and horn heater remain on at all times. Ensure compressed air is moisture free.
- f) Slack down all signal halyards.
- g) Radar scanners to be kept running at all times.
- h) Special attention should be taken to avoid freezing of navigation and deck lights.
- i) Switches for the duct heaters to be switched on (where fitted).
- j) Clear-view screens to be kept running when needed.
- k) A container of coarse salt to be kept readily at hand in the wheelhouse especially in pilotage waters to prevent slipping accidents.
- l) Search lights, port and starboard, to be functional.

- m) Ensure trace-heating to EPIRB is on. It comes on automatically by thermostatic control as the temperature drops below  $-2^{\circ}\text{C}$ .
- n) Engine control air should be free of moisture. Line passage through cable trunk should be protected from freezing.



**Figure 9.1A – Navigation charts used as insulation, impairing visibility on bridge**



**Figures 9.1B – Deficient wheelhouse heating combined with a high rate of humidity**

## 10. BALLAST OPERATION

### 10.1 BALLAST – CARGO CONDITION

Bring the vessel down in the water to a draught at which the sea suction and propeller are well below the level of any ice. When taking this action, ensure that the vessel remains at a safe draught with adequate under keel clearance.

Restrict the trim (1 to 3 metres - preferably no more than 1 meter) to avoid the possibility of ice moving under the bottom of the ship and being picked-up by the sea suction.

Take in cargo prior to discharging ballast to maintain the maximum safe draught (seen in relation to the level of ice).

If discharging cargo, reverse the procedure outlined above. Maintain maximum safe draught by taking in ballast simultaneously while discharging.

*Note : This procedure may be unsuitable with freshwater ballast in extreme cold conditions. Seek local advice.*

### 10.2 COLD WEATHER PRECAUTION PROCEDURES WITH BALLAST

- a) Seawater freezes around  $-3^{\circ}\text{C}$  ( $28^{\circ}\text{F}$ ). Ensure only warm seawater ballast is retained onboard, i.e. ballast to be exchanged in mid-Atlantic as per specified procedures. Freshwater temperature record tables are included for Montreal, Sorel, Trois-Rivières, and Québec.
- b) Steam heating opened on all wing ballast tanks (where fitted), even in empty tanks. This will prevent condensate freezing and damaging lines.
- c) To allow for expansion due to freezing, slack down all ballast tanks and freshwater tanks which are pressed up. When alongside, if practical, empty ballast tanks to below waterline to prevent freezing. Pour environmentally safe antifreeze liquid into sounding pipes to prevent freezing of water in the pipe or use heaving lines for same reason. In severe winter conditions, where double bottoms are used for main engine internal cooling, stability calculations should be taken into account for resultant loss in stability, if required to slack the tanks.
- d) Ballasting and de-ballasting operations to be carried out only after confirming air-pipes are clear. Continuously monitor ballast pump gauges. When de-ballasting, it is advisable to strip each tank completely to prevent freezing of any small volumes of water.
- e) Ensure steam to heating coils in freshwater tanks are cracked open (if fitted). Monitor temperatures of freshwater tanks at regular intervals.
- f) Note, ballast water does not freeze below the waterline, except when cargo hatches are open.

Montréal - Automne - 2003 - Fall  
Température de l'eau - Water temperature

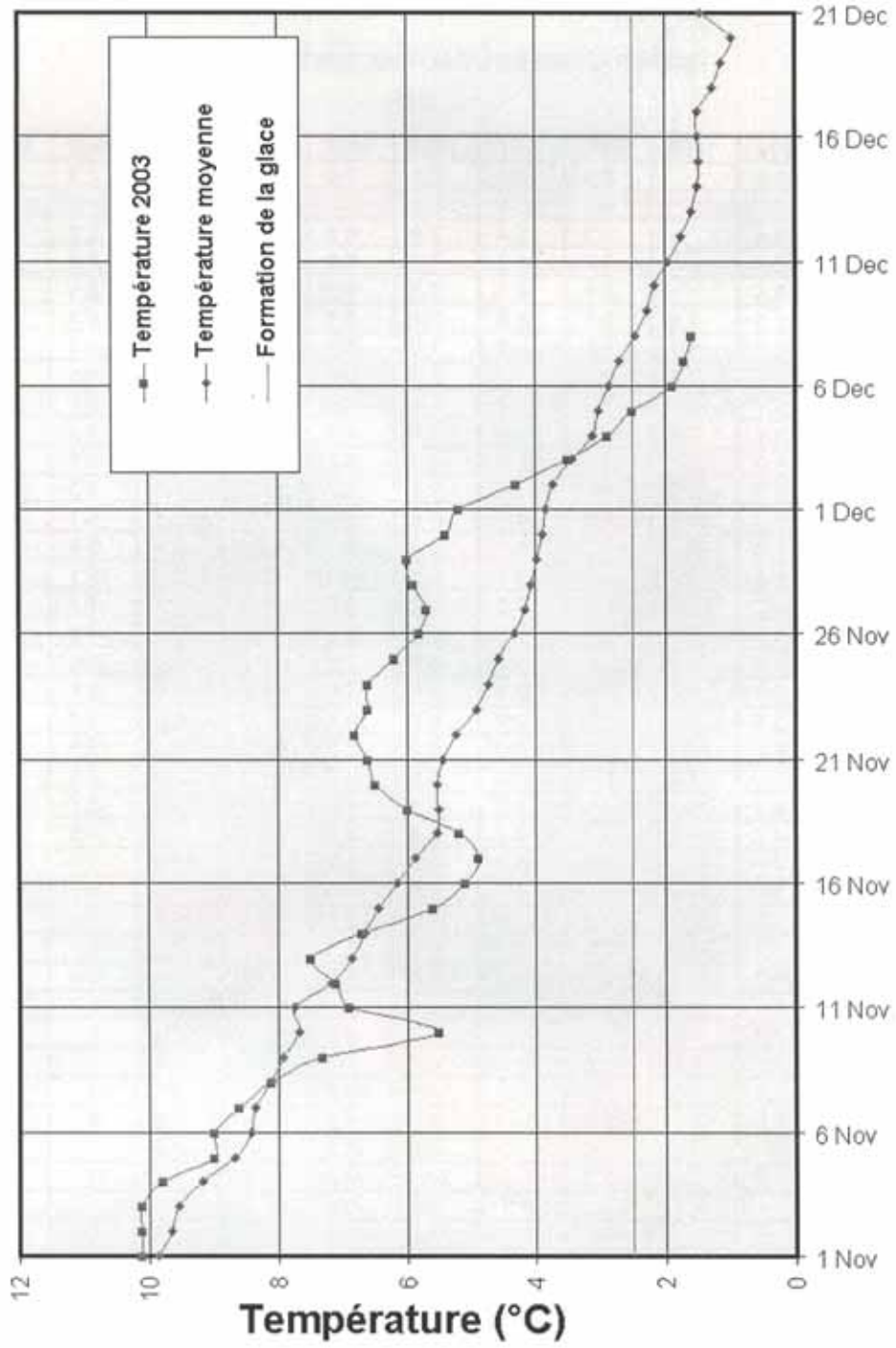

MONTREAL

TEMPERATURE DE L'EAU - WATER TEMPERATURE °C

	1994	1995	1996	1997	1998	1999	2000	2001	2002	2003	MOY /AVG
10-Nov	9.6		8.5	8.4	8.1	7.6	10.5	7.8	7.9	5.5	8.2
11-Nov	8.7		8.3	8.0	8.7	7.2	10.3	7.8	7.9	6.9	8.2
12-Nov	8.4		7.3	7.4	7.9	6.8	9.6	7.2	8.3	7.1	7.8
13-Nov	8.4		6.7	6.7	7.7	6.8	9.6	6.6	8.3	7.5	7.6
14-Nov	8.5		5.8	6.3	7.3	7.2	9.3	6.6	8.1	6.7	7.3
15-Nov	9.1	4.9	5.1	5.4	7.4	7.1	8.5	7.2	8.4	5.6	6.9
16-Nov	9.6	4.7	4.8	5.2	7.0	6.2	7.9	7.7	8.2	5.1	6.6
17-Nov	8.5	4.6	4.8	5.0	6.7	5.2	7.6	7.8	6.5	4.9	6.2
18-Nov	8.7	4.1	4.8	4.7	5.9	4.5	6.9	7.1	5.2	5.2	5.7
19-Nov	8.5	3.8	4.9	4.6	5.9	4.7	6.3	7.4	4.8	6.0	5.7
20-Nov	8.9	3.8	5.1	4.9	6.1	5.2	6.5	7.7	4.7	6.5	5.9
21-Nov	8.1	4.2	4.7	5.0	6.2	5.7	6.2	6.9	5.2	6.6	5.9
22-Nov	8.3	4.2	4.4	4.8	6.0	6.2	5.5	6.5	5.7	6.8	5.8
23-Nov	7.4	3.7	4.2	4.1	5.9	6.7	4.6	6.9	5.9	6.6	5.6
24-Nov	5.3	3.2	3.5	3.7	6.3	7.0	3.9	6.6	5.1	6.6	5.1
25-Nov	4.7	2.6	3.3	3.3	6.2	6.8	3.5	7.1	4.9	6.2	4.9
26-Nov	4.9	2.6	3.1	3.1	5.9	6.6	3.7	7.8	4.5	5.8	4.8
27-Nov	4.6	2.8	2.7	3.3	5.9	7.2	4.0	8.3	3.6	5.7	4.8
28-Nov	3.9		2.7	2.9	5.9	7.0	4.4	7.0	3.4	5.9	4.8
29-Nov	3.9		2.6	2.7	5.7	6.1	4.8	6.4	3.3	6.0	4.6
30-Nov	4.4		2.7	3.0	5.7	5.5	4.7	5.5	3.3	5.4	4.5
1-Dec	3.9		3.1	2.9	6.3	4.5	4.4	5.5	3.5	5.2	4.4
2-Dec	4.1		4.0	2.6	6.1	4.2	3.6	5.8	2.5	4.3	4.1
3-Dec	4.4		3.5	2.2	6.4	4.2	2.7	5.9	1.6	3.5	3.8
4-Dec	4.8		3.3	1.8	6.2	4.7	2.5	6.0	0.4	2.9	3.6
5-Dec	5.0		3.2	2.0	5.9	4.8	2.4	6.2		2.5	4.0
6-Dec	5.2		3.2	2.3	5.8	5.5	1.7	6.5		1.9	4.0
7-Dec	5.1		2.9	2.4	5.9	5.4	0.7	6.5		1.7	3.8
8-Dec	4.2		2.9	2.5	5.4	5.0		5.9		1.6	3.9
9-Dec	3.3		3.1	2.1	5.0	4.5		5.8			4.0
10-Dec	3.1		3.1		4.7	4.5		5.1			4.1
11-Dec	2.5		3.0		4.7	4.3		4.8			3.9
12-Dec	1.5		2.7		4.5	3.9		4.9			3.5
13-Dec	0.6		2.6		4.5	3.2		4.6			3.1
14-Dec	0.3		2.6		4.4	3.2		5.0			3.1
15-Dec	0.5		2.8		4.1	3.0		4.6			3.0
16-Dec			2.9		4.6	3.0		4.0			3.6
17-Dec			3.2		4.5	3.1		3.6			3.6
18-Dec			3.5		3.9	2.2		3.1			3.2
19-Dec			3.4		3.2	1.5		3.3			2.9
20-Dec			2.9		2.6	1.3		3.8			2.7
21-Dec			1.9			1.7		3.3			2.3



*Sorel - Automne - 2003 - Fall*  
Température de l'eau - Water temperature

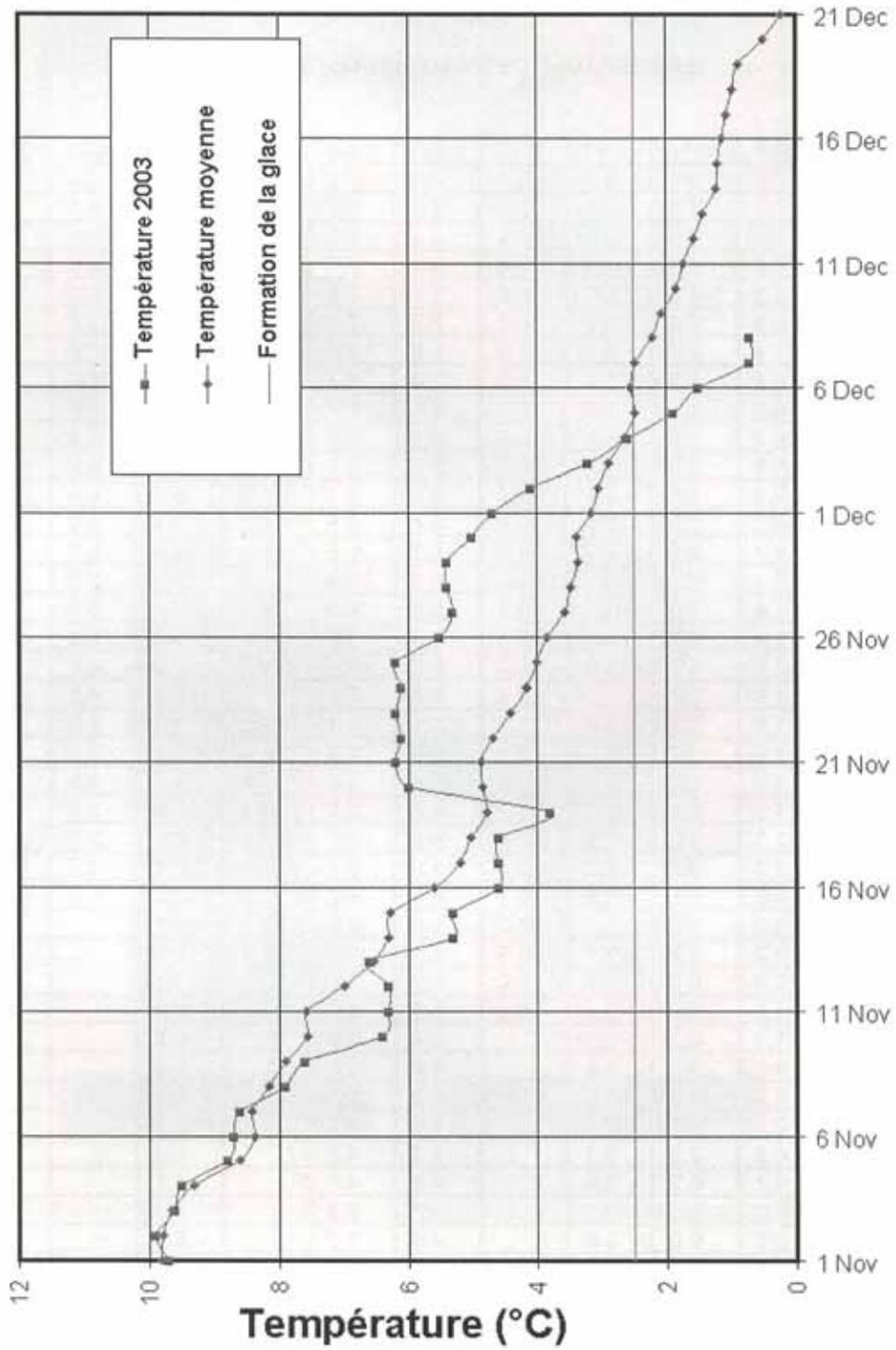



SOREL

TEMPERATURE DE L'EAU - WATER TEMPERATURE °C

											MOY
	1994	1995	1996	1997	1998	1999	2000	2001	2002	2003	/AVG
10-Nov	7.9	5.1	9.1	8.7	8.1	7.9	10.1	8.6	7.4	6.4	7.9
11-Nov	7.3	4.7	8.7	8.5	8.4	7.7	10.1	8.3	8.0	6.3	7.8
12-Nov	7.1	5.5	8.1	7.9	8.4	7.2	9.7	7.8	8.7	6.3	7.7
13-Nov	6.8	4.8	7.3	7.3	8.2	7.4	9.3	7.4	8.6	6.6	7.4
14-Nov	6.3	4.3	6.7	6.8	7.7	7.8	9.1	7.2	8.6	5.3	7.0
15-Nov	6.9	3.5	6.0	6.2	7.7	7.7	8.9	7.7	8.6	5.3	6.9
16-Nov	7.4	3.2	5.4	5.8	7.5	7.0	8.4	7.8	7.8	4.6	6.5
17-Nov	6.4	3.2	5.4	5.5	7.0	6.3	8.1	7.1	6.6	4.6	6.0
18-Nov	6.3	2.7	5.2	5.1	6.6	5.7	7.5	7.4	5.6	4.6	5.7
19-Nov	6.7	2.5	5.3	4.9	6.4	5.5	6.9	7.9	5.3	3.8	5.5
20-Nov	6.8	2.5	5.3	5.2	6.3	5.5	6.7	8.3	5.2	6.0	5.8
21-Nov	6.4	2.6	5.4	5.4	6.5	6.1	6.6	8.0	5.5	6.2	5.9
22-Nov	6.3	2.9	5.0	5.3	6.4	6.5	6.2	7.4	5.8	6.1	5.8
23-Nov	5.3	2.5	4.8	4.5	6.2	6.9	5.4	7.4	6.0	6.2	5.5
24-Nov	3.8	2.1	4.1	4.2	6.5	7.3	4.6	7.3	5.7	6.1	5.2
25-Nov	2.9	1.5	3.8	4.1	6.5	7.5	4.2	7.5	5.4	6.2	5.0
26-Nov	2.4	1.2	3.7	3.5	6.3	7.4	4.1	8.3	5.2	5.5	4.8
27-Nov	2.2	1.1	3.2	3.7	6.2	7.4	4.2	8.2	4.9	5.3	4.6
28-Nov	1.6	1.4	3.0	3.4	6.2	7.7	4.6	7.6	4.3	5.4	4.5
29-Nov	1.5	1.1	3.0	3.2	6.1	7.1	4.9	7.0	3.8	5.4	4.3
30-Nov	1.9	0.7	3.1	3.2	6.1	6.5	4.9	6.3	3.8	5.0	4.2
1-Dec	1.8	0.4	3.2	3.3	6.4	5.6	4.7	6.3	3.9	4.7	4.0
2-Dec	1.9	0.3	3.8	3.1	6.6	5.1	4.2	6.6	2.9	4.1	3.9
3-Dec	2.1	0.3	3.9	3.0	6.5	5.1	3.4	6.6	2.6	3.2	3.7
4-Dec	2.7	0.3	3.7	2.5	6.5	5.0	3.0	6.4	1.3	2.6	3.4
5-Dec	3.0	0.3	3.8	2.4	6.4	5.2	2.9	6.8	0.8	1.9	3.4
6-Dec	3.2	0.3	3.6	2.7	6.2	5.6		7.1		1.5	3.8
7-Dec	3.2	0.3	3.1	2.9	6.1	6.1		7.3		0.7	3.7
8-Dec	2.4	0.3	3.3	3.0	6.2	5.9		6.8		0.7	3.6
9-Dec	1.7	0.2	3.4	2.9	5.5	5.6		6.4			3.7
10-Dec	1.1	0.2	3.3		5.4	5.6		6.0			3.6
11-Dec	0.5	0.2	3.4		5.4	5.4		5.8			3.5
12-Dec	0.2	0.2	3.3		5.3	4.8		5.6			3.2
13-Dec	0.1	0.2	3.0		5.0	4.5		5.3			3.0
14-Dec	0.0	0.2	3.1		5.1	4.2		5.6			3.0
15-Dec	0.1	0.2	3.3		4.6	4.0		5.7			3.0
16-Dec	0.0	0.2	3.3		4.7	3.8		4.9			2.8
17-Dec	0.0	0.0	3.6		4.9	3.9		4.6			2.8
18-Dec	0.0	0.0	3.8		4.3	3.5		4.3			2.7
19-Dec	0.0	0.0	3.9		4.0	2.7		4.2			2.5
20-Dec	0.0	0.0			4.5	2.4					1.7
21-Dec	0.0	0.0				2.3					0.8

*Trois-Rivières - Automne - 2003 - Fall*  
Température de l'eau - Water temperature

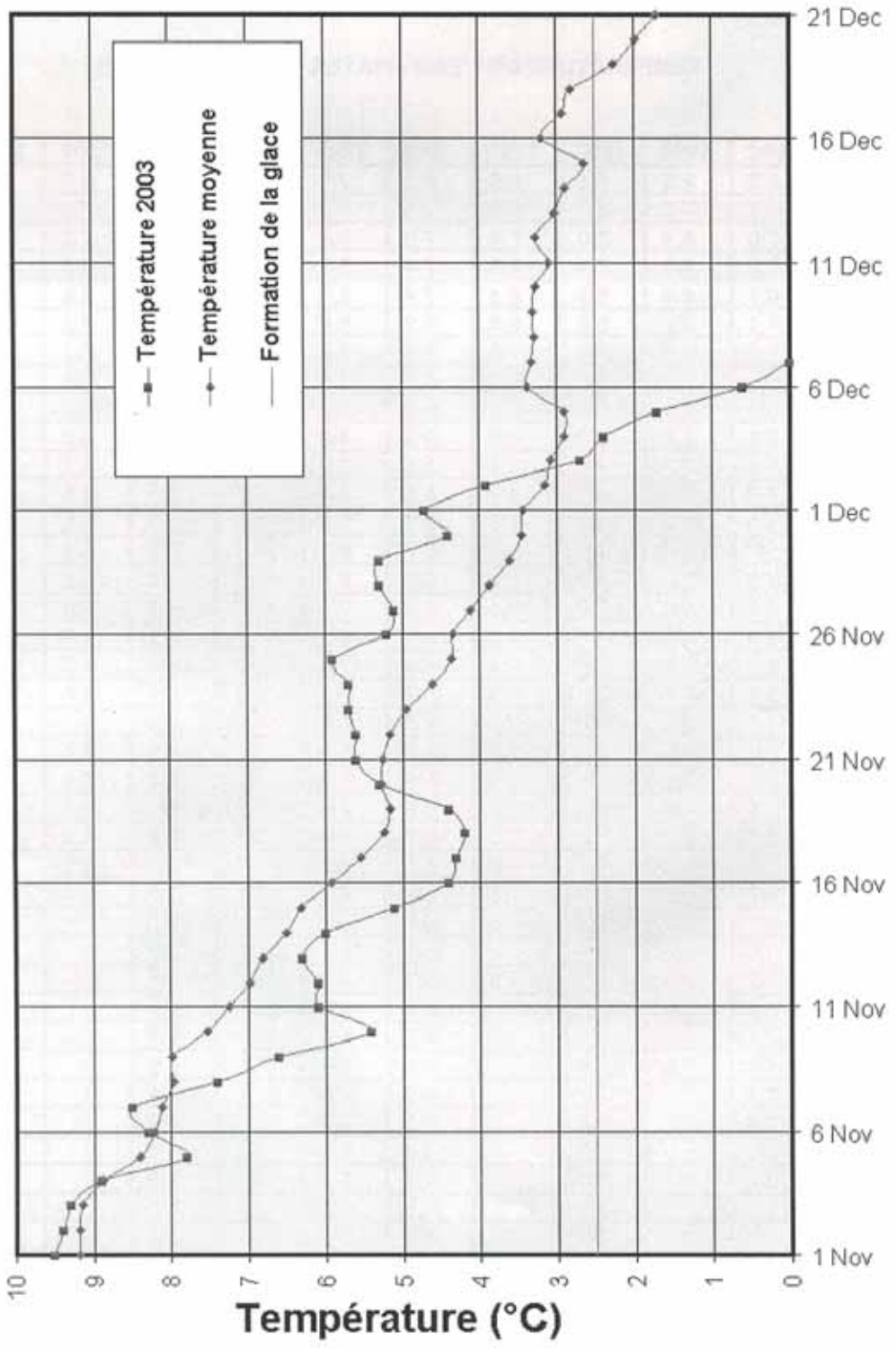

TROIS-RIVIÈRES

TEMPERATURE DE L'EAU - WATER TEMPERATURE °C

	1994	1995	1996	1997	1998	1999	2000	2001	2002	2003	MOY /AVG
10-Nov	8.2	4.5	8.6	8.6	8.1	7.6	9.8	8.1	6.5	5.4	7.5
11-Nov	6.7	4.0	8.7	8.0	7.6	7.1	9.5	7.5	7.2	6.1	7.2
12-Nov	7.0	5.4	8.0	7.4	7.8	6.6	9.3	7.0	7.9	6.1	7.3
13-Nov	7.2	4.9	7.4	7.3	7.4	5.7	9.0	6.8	8.3	6.3	7.0
14-Nov	6.7	4.0	6.2	6.3	7.4	7.1	8.8	6.5	8.4	6.0	6.7
15-Nov	7.1	3.6	5.8	5.8	6.9	6.9	8.4	7.1	8.2	5.1	6.5
16-Nov	7.1	2.9	5.2	5.6	6.4	6.3	8.0	7.4	7.2	4.4	6.1
17-Nov	6.6	3.0	5.0	4.7	6.6	5.4	7.8	7.5	6.0	4.3	5.7
18-Nov	6.6	2.9	5.0	4.5	6.0	5.2	6.5	7.4	4.7	4.2	5.3
19-Nov	7.1	2.6	5.0	4.0	5.8	5.3	6.4	7.4	4.3	4.4	5.2
20-Nov	7.4	2.1	4.8	4.8	5.5	4.9	6.3	7.9	4.7	5.3	5.4
21-Nov	7.0	2.3	5.1	4.9	5.5	5.3	6.1	7.3	4.8	5.6	5.4
22-Nov	6.8	2.7	4.9	4.5	5.7	5.9	5.6	6.8	5.3	5.6	5.4
23-Nov	5.7	2.5	4.7	3.8	5.7	6.1	4.5	6.9	5.3	5.7	5.1
24-Nov	4.3	2.2	3.9	2.9	5.9	6.5	4.5	6.8	5.2	5.7	4.8
25-Nov	3.5	2.1	2.9	3.1	5.8	7.1	3.2	7.2	5.0	5.9	4.6
26-Nov	3.9	1.9	3.1	3.0	6.1	6.9	3.4	8.1	4.7	5.2	4.6
27-Nov	3.2	1.8	2.6	2.9	5.4	7.0	3.2	7.9	4.2	5.1	4.3
28-Nov	3.1	1.0	2.2	2.3	5.7	7.2	3.5	7.1	3.4	5.3	4.1
29-Nov	1.6	0.8	2.4	2.2	5.8	6.8	4.2	6.3	2.7	5.3	3.8
30-Nov	2.4	0.6	2.7	2.6	5.6	6.3	4.1	4.9	2.6	4.4	3.6
1-Dec	2.5	0.7	2.9	2.6	5.9	5.3	4.0	4.7	2.9	4.7	3.6
2-Dec	1.9	0.7	3.2	2.2	5.6	4.9	3.3	5.7	1.7	3.9	3.3
3-Dec	2.9	0.4	3.4	2.6	6.2	4.4	2.5	6.0	1.3	2.7	3.2
4-Dec	3.5	0.4	2.3	2.4	5.8	4.8	2.0	6.0	0.6	2.4	3.0
5-Dec	3.7	0.3	3.2	1.9	5.9	4.7	2.0	6.3	0.4	1.7	3.0
6-Dec	3.7	0.2	3.2		5.7	5.2		6.6		0.6	3.6
7-Dec	4.0	0.2	2.8		5.8	5.3		6.3		0.0	3.5
8-Dec	3.2	0.2	2.7	1.5	5.2	5.4		6.1			3.5
9-Dec	2.8	0.2	2.8		4.9	4.9		5.7			3.6
10-Dec	2.4	0.2	3.1		4.8	5.3		5.4			3.5
11-Dec	1.9	0.1	2.9		4.6	5.1		5.2			3.3
12-Dec	1.1		2.7		4.9	4.4		5.1			3.6
13-Dec	0.6		2.8		4.3	4.3		4.9			3.4
14-Dec	0.3		2.3		4.3	4.1		5.1			3.2
15-Dec	0.2		2.4		4.1	3.3		4.9			3.0
16-Dec			3.2		4.5	3.1		4.2			3.8
17-Dec			3.3		4.1	3.2		3.3			3.5
18-Dec			3.6		3.9	2.5		3.5			3.4
19-Dec					2.7	2.2		3.6			2.8
20-Dec					2.1	1.7		3.6			2.5
21-Dec						1.3		3.0			2.2

**Québec - Automne - 2003 - Fall**  
**Température de l'eau - Water temperature**

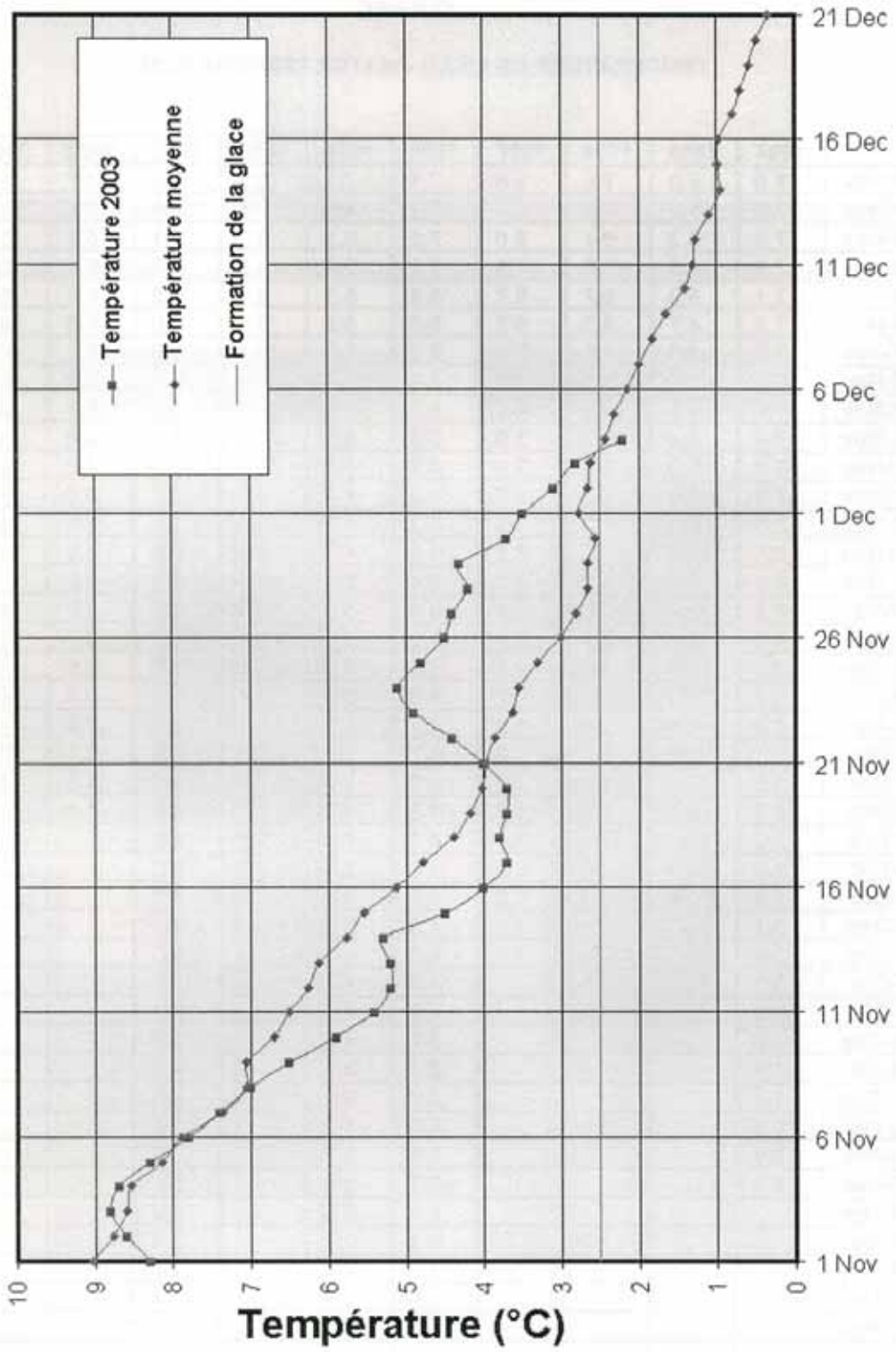



QUÉBEC

TEMPERATURE DE L'EAU - WATER TEMPERATURE °C

	1994	1995	1996	1997	1998	1999	2000	2001	2002	2003	MOY /AVG
10-Nov	8.0	5.8	7.5	8.6	7.7	7.1	9.1	7.9	4.7	5.9	7.2
11-Nov	7.6	5.3	7.9	8.3	7.5	6.6	9.1	7.5	4.9	5.4	7.0
12-Nov	7.8	5.3	6.7	8.0	7.2	6.1	9.1	7.1	5.3	5.2	6.8
13-Nov	7.6	4.9	7.0	7.4	7.1	5.6	8.9	6.6	6.1	5.2	6.6
14-Nov	7.1	5.0	5.7	6.7	6.8	5.3	8.7	6.2	6.5	5.3	6.3
15-Nov	7.1	4.7	5.3	6.2	6.6	5.2	8.5	6.0	6.8	4.5	6.1
16-Nov	7.5	4.0	4.1	5.6	6.2	5.5	8.1	6.0	6.7	4.0	5.8
17-Nov	7.2	4.0	3.6	4.7	5.6	5.4	7.9	6.2	6.2	3.7	5.5
18-Nov	7.2	3.5	3.6	4.2	5.5	4.9	7.3	6.3	5.7	3.8	5.2
19-Nov	7.3	3.4	3.7	3.9	5.3	4.6	6.7	6.3	4.6	3.7	5.0
20-Nov	7.6	3.2	3.8	3.6	4.8	4.3	6.3	6.3	4.0	3.7	4.8
21-Nov	7.6	3.0	3.9	3.6	4.5	4.4	6.0	6.0	3.8	4.0	4.7
22-Nov	7.5	3.1	4.0	3.9	4.3	4.5	5.7	6.1	3.8	4.4	4.7
23-Nov	6.4	3.2	4.1	3.5	4.5	4.7	5.2	6.3	3.9	4.9	4.7
24-Nov	5.9	3.1	3.7	3.1	4.8	5.0	4.4	6.0	3.8	5.1	4.5
25-Nov	4.8	2.9	3.0	2.7	5.0	5.5	4.2	6.0	3.7	4.8	4.3
26-Nov	4.3	2.6	2.5	2.4	4.9	5.8	3.8	6.3	3.7	4.5	4.1
27-Nov	3.7	2.8	1.9	2.3	4.7	5.9	3.4	6.5	3.6	4.4	3.9
28-Nov	3.2	2.0	1.7	2.2	4.6	6.0	3.1	6.5	3.3	4.2	3.7
29-Nov	2.8	1.3	1.4	1.8	4.7	5.8	3.1	6.4	2.8	4.3	3.4
30-Nov	2.1	0.8	1.0	1.6	4.7	5.5	3.1	5.9	2.4	3.7	3.1
1-Dec	2.0	0.4	1.2	1.6	4.8	5.2	3.3	5.3	1.9	3.5	2.9
2-Dec	1.9		1.5	1.8	4.8	4.6	3.3	4.5	1.6	3.1	3.0
3-Dec	2.2		2.1	1.7	4.8	4.0	2.8	4.4		2.8	3.1
4-Dec	2.5		2.4	1.5	4.9	3.8	2.5	4.5		2.2	3.0
5-Dec	2.8		2.4	1.8	4.9	3.8	2.1	4.9			3.2
6-Dec	3.1		2.4	1.8	4.8	3.9		4.9			3.5
7-Dec	3.5		2.0	1.5	4.6	4.1		5.3			3.5
8-Dec	3.1		1.8		4.2	4.2		5.3			3.7
9-Dec	2.6		1.6	1.1	4.2	4.2		5.2			3.2
10-Dec	1.5				3.7	4.2		4.9			3.6
11-Dec	1.5				3.7	4.2		4.5			3.5
12-Dec	1.4				3.7	4.2		4.0			3.3
13-Dec	0.8				3.5	4.0		3.9			3.1
14-Dec	0.0				3.6	3.7		3.9			2.8
15-Dec	0.0				3.5	3.4		3.5			2.6
16-Dec					3.4	3.0		3.2			3.2
17-Dec					3.4	2.7		2.8			3.0
18-Dec					3.2	2.4		2.5			2.7
19-Dec					2.9	1.9		2.4			2.4
20-Dec					2.5	1.5		2.4			2.1
21-Dec						1.3		2.4			1.9

## 11. CARGO HOLD

### 11.1 TANKER – CARGO HEATING SYSTEMS

- a) Drain and blow through cargo heating inlet lines, coils and exhaust lines to remove all presence of water.
- b) If cargo heating is required during the voyage, carry out the following :
  - i. turn on the cargo heating steam before encountering temperatures near freezing;
  - ii. keep the heating on until reaching warmer climates; and
  - iii. blow the coils and lines through with air immediately after turning off the steam.
- c) Install a small diameter line (jumper line) between the supply and return manifolds on the forward tanks to prevent freezing of the exhaust returns.
- d) Test all steam and exhaust valves for tightness so as to prevent leakage into “dry lines”.
- e) Ensure deck seal water heater is on.
- f) On the inert gas system :
  - i. The liquid filled pressure-vacuum breakers will operate at the required pressure only if it is filled to the correct level with liquid of the correct density.
  - ii. Either a suitable oil or a freshwater/glycol mixture should be used to prevent freezing in cold weather.

### 11.2 CARGO

Opening of cargo hatches for considerable periods may freeze water ballast in double bottom tanks as well as in side tanks.

Washing and drying cargo holds could be performed if necessary. The following recommendations should be adhered to :

- a) Precaution of washwater line freezing (see [section 4 – Deck Equipment](#)).
- b) Cargo hold bilge wells are to be stripped dry.
- c) Cargo hold heating guidelines are to be followed (refer to 11.3).



### **11.3 SAFETY NOTICE**

**SUBJECT : Use of propane heating apparatus in ships' cargo holds**

#### **INTRODUCTION**

The various hazards related to the use of propane and the serious consequences thereof demonstrate the need to supervise the operations where propane heating apparatus are used for drying-out ships' cargo holds. These heating operations for drying-out cargo holds are normally carried out with the hatch covers partly closed in order to keep the heat inside the cargo holds. Consequently, accumulation of gas and/or carbon monoxide could be lethal for the people working onboard and could be the source of explosions.

The use of such propane heating apparatus for drying-out cargo holds should therefore be carried out in accordance with the recommendations set herein.

The propane safety material data sheets (SMDS) should be available and referred to.

#### **CLASSIFICATION OF PROPANE**

WHMIS : Class A – Compressed gas;  
Class B, Division 1 – Flammable gas.

DGT : Class 2.1, Flammable gas;  
Identification number UN1075 – Liquefied petroleum gas  
UN1978 - Propane

#### **QUALIFICATION OF PERSONNEL**

All operations involving the use or manipulation of propane and propane working apparatus must be supervised by personnel adequately qualified for handling propane by a recognised organism for the entire duration of such operations. A recognised organism is meant to be organisms such as the Canadian Propane Association, the Propane Training Institute, Superior Propane, or provincial equivalent (*Régie du Bâtiment du Québec*, Ontario Propane Association, etc.).

#### **APPROVAL OF EQUIPMENT**

Each component of the system must be approved concerning their type and classification (cylinders, valves, connectors, regulators, manifolds and hoses). The only liquefied petroleum gas cylinders that can be used for such operations are those cylinders meeting the requirements of the general direction of Transport Canada's Dangerous Goods Transportation.



Other than the storage cylinders, only the gas units and combustible gas apparatus meeting the requirements of the Canadian Gas Association, the Compressed Gas Association, the Underwriters' Laboratories of Canada, or the Underwriters' Laboratories Incorporated can be used.

## **SAFE USE OF EQUIPEMENT**

The propane cylinders must be installed and remain outside of the cargo holds, be carefully handled and properly stowed in specially made racks for the entire duration of the heating operations. The heating apparatus should be installed in accordance with the manufacturer's recommendations and be stowed in such a way as to minimise any movement of those apparatus when the ship is in transit.

All control equipment of the gas circuit provided for the release, regulation or pressure control and the flow of gas should be rigidly mounted at a location providing easy access for use, inspection, maintenance and trial, and be suitable protected against damage.

Excess flow valves should be installed in such a way as to minimise the flow of gas in the system in case where the supply line should be damaged.

All apparatus having a pilot burner or other continuous flame devices should be fitted with a feature that will stop the supply of gas in case of flame failure.

## **GAS DETECTION EQUIPMENT AND « SAFE FOR ENTRY » CERTIFICATES**

Gas detectors capable of measuring at least the oxygen content, carbon monoxide content and lower explosive level (LEL) should be used to monitor and measure the quality of the air in each cargo hold where heating operations will be carried out.

Readings must be taken by qualified personnel using appropriate equipment, approved and duly calibrated. A certificate will be required at the end of the heating operations for every cargo hold indicating, as a minimum, the oxygen content, carbon monoxide content and lower explosive level (LEL).

It is meant by qualified personnel, a person who, due to its knowledge, training and experience, is qualified to carry out such operation in a suitable and safe manner.

## **EMERGENCY AND FIRST AID PROCEDURES**

Emergency and first aid procedures should be put in place.

Cargo holds where heating operations are carried out must be protected against fire by a suitable number of BC type fire extinguishers.