

GUIDE

TO ENERGY EFFICIENCY IN ALUMINUM SMELTERS



Natural Resources
Canada

Ressources naturelles
Canada

Office of Energy Efficiency

Office de l'efficacité énergétique



ASSOCIATION DE L'ALUMINIUM DU CANADA
ALUMINIUM ASSOCIATION OF CANADA

Guide to Energy Efficiency in Aluminum Smelters

A Joint Project by:

**the Aluminum Association of Canada
Natural Resources Canada
the Office of Energy Efficiency
and the
Canadian Industry Program for Energy Conservation (CIPEC)**



Natural Resources
Canada

Ressources naturelles
Canada

Office of Energy Efficiency

Office de l'efficacité énergétique



ASSOCIATION DE L'ALUMINIUM DU CANADA
ALUMINIUM ASSOCIATION OF CANADA



ASSOCIATION DE L'ALUMINIUM DU CANADA
ALUMINIUM ASSOCIATION OF CANADA

1010, Sherbrooke ouest, Bureau 1600, Montréal (Québec) Canada H3A 2R7
Téléphone : (514) 288-4842 Fax : (514) 288-0944 e-mail : associa@aluminium.qc.ca

The Aluminum Association of Canada represents all five Canadian primary aluminum producers that together operate eleven aluminum smelters. For many years an active participant in the Canadian Industry Program for Energy Conservation (CIPEC), the Association has set up a task force on energy efficiency.

Action plans have been submitted yearly and tangible measures have been introduced in each of the plants, yielding excellent results.

Natural Resources Canada, acting through the Office of Energy Efficiency, suggested producing a guide intended especially for the aluminum industry. Thanks to financial support from the Government of Canada, the firm Soprin-ADS was entrusted with the mandate of producing this guide.

All rights reserved. Reproduction under any form, memorization in a documentary system or transmission in whole or in part of this publication, through any process whatsoever, more particularly in electronic, mechanical, photocopy or recording form, are prohibited without prior written authorization by the Aluminum Association of Canada.

The use of trademarks or company names is not for the purpose of promoting any product or commercial system.

April 1998



GUIDE TO ENERGY EFFICIENCY IN ALUMINUM SMELTERS

Under the direction of:

- Pierre Langlois, P. Eng.
Vice-President, Development
Energy Efficiency and Renewable Energies
Soprin ADS
- Christian L. Van Houtte
President
Aluminum Association of Canada

Authors:

Pierre Baillargeon, P. Eng.
Manager, Energy
Soprin ADS

Dominique Leclerc, P. Eng.
Project Manager, Industry and Energy
Soprin ADS

Hakim Zahar, P. Eng.
Manager, Industry and Energy
Soprin ADS

In Cooperation With:

- Yvan Robitaille, P. Eng.
Project Manager, Industry and Energy
Soprin ADS
- Christian L. Van Houtte
President
Aluminum Association of Canada

TABLE OF CONTENTS

FOREWORD

INTRODUCTION

1.0 CONVENTIONAL ENERGY EFFICIENCY MEASURES 1

 1.1 Conversion from One Energy Form to Another 1

 1.2 Controlling Electrical Demand 3

 1.3 Replacing an Existing Motor with a High-Performance Motor 3

 1.4 Installing a Variable-Speed Drive (VSD) on an Electrical Motor 6

 1.5 Optimizing Operation of Compressed Air Systems 7

 1.6 Optimizing Operation of Ventilation Systems 8

 1.7 Installation of Insulating Material 9

2.0 ENERGY EFFICIENCY MEASURES SPECIFIC TO THE ALUMINUM INDUSTRY 11

 2.1 Optimizing Burner Positioning to Enhance Heat Transfer in Reverberatory Furnaces 11

 2.2 Improving Air Tightness in Furnaces 20

 2.3 Installing Heat Recovery Devices on Exhaust Stacks of Aluminum Melting Furnaces 24

 2.3.1 Heat Source 25

 2.3.2 Recovered Heat ReInjection Point 27

 2.3.3 Technical Considerations of Heat Recovery 28

 2.3.4 Potential Use of Recovered Heat 30

 2.4 Heat Recovery Systems 37

 2.4.1 Heat Exchangers 37

 2.4.2 Heat Regenerators 44

3.0 OTHER MEASURES APPLICABLE TO ALUMINUM SMELTERS 49

 3.1 Melting of Secondary Aluminum Using Oxy-Fuel 49

 3.2 Installing a Circulating Pump in Melting Furnaces 50

 3.3 Installation of Real-Time Controls for the Cooling of Aluminum Ingots 51

4.0 CONCLUSION 52

BIBLIOGRAPHY 53

TABLE

Table 1 Percentage Fuel Saved through Preheating of Combustion Air 36

TABLE OF CONTENTS (cont'd)

FIGURES

Figure 1	Typical Performance by Standard and High-Performance Motors.....	5
Figure 2	Power of a Typical Ventilation System as a Function of Flow, According to Various Mechanisms	7
Figure 3	Heat Transfer in a Reverberatory Furnace.....	15
Figure 4	Placement and Positioning of Burners in Furnace for Radiating Heat Transfer.....	17
Figure 5	Placement and Positioning of Burners in Reverberatory Furnace for Convection Heat Transfer	18
Figure 6	Airflow through a 1/2-Inch Gap Around Furnace Door.....	24
Figure 7	Typical Heat Usage Statement (Stable State).....	26
Figure 8	Furnace with Radiating Tubes Equipped with Heat Recovery Devices and a Preheating Unit	32
Figure 9	Heat Recovery Using Two Furnaces.....	33
Figure 10	Radiating Type Heat Exchangers	39
Figure 11	Convection Type Heat Exchangers	40
Figure 12	Plate Type Heat Exchangers	41
Figure 13	Crucible Furnace Equipped with a Self-Recovering Burner	42
Figure 14	Submerged Natural Gas Burner	43
Figure 15	Heat Regeneration.....	45
Figure 16	Self-Recovering Burner	46
Figure 17	Recirculating Combustion Gases.....	47

FOREWORD

This guide to energy efficiency in aluminum smelters has been prepared at the initiative of the Aluminum Association of Canada. It was written by Soprin ADS, a private company specializing for over twenty years in energy efficiency as well as energy management. It was made possible through the financial support of the Department of Natural Resources Canada.

The guide, prepared under the supervision of the Aluminum Association of Canada, bears more precisely on some potential improvements aimed at reducing energy consumption in aluminum smelters. We hope that the information contained in this document will be conducive to the awareness and knowledge of the engineering and operation personnel about the rational use of energy and the opportunity to apply energy efficiency concepts in the discharge of their duties.

The members of the teams who drafted this report wish to thank everybody having contributed to the completion of this work, and more particularly Mr. Christian L. Van Houtte, President of the Aluminum Association of Canada as well as the Association's task force on energy. We also wish to thank Messrs. Marc Montembeault and Gilles Dufour of the Lauralco Smelter who agreed to have us tour their facilities and provide answers to our questions.

Pierre Baillargeon, P. Eng.
Manger, Energy
Soprin ADS
Longueuil, March 1998

Dominique Leclerc, P. Eng.
Project Manager, Industry and Energy
Soprin ADS
Quebec, March 1998

Hakim Zahar, P. Eng.
Manager, Industry and Energy
Soprin ADS
Quebec, March 1998

INTRODUCTION

The aluminum industry is constantly looking for ways to reduce costs and improve product quality. In this respect, with regard to processes involving heating apparatuses, it is often through reduced energy consumption that better output performance is achieved. This search for energy conservation must however be conducted in an orderly fashion, with priorities being well established and met to ensure that all means used lead to concrete, optimal and profitable results. Upon prioritization, the analysis of any interaction among the various energy conservation measures selected will more often than not dictate the future implementation schedule as well as relative profitability.

The establishment of such priorities is obviously a function of several factors such as production capability, age and condition of equipment involved. The feasibility of energy efficiency measures being considered as well as their corresponding profitability may be assessed only after individual analysis for each plant based primarily on its own energy costs.

The prioritization of energy efficiency measures to be implemented in a given plant is often drawn by an energy committee bringing together personnel from various plant sectors, or by a plant management. All persons so involved determine actions to be undertaken to implement measures selected for the plant and afford themselves the means to carry out proper monitoring of results achieved on the basis of energy consumption at the plant.

Generally, these people start by setting an energy consumption objective for the plant or for one of its departments, in conjunction primarily with product forecasts as well as plant maintenance and operating budgets. This objective is defined on the basis of an energy billing period, often referred to as a billing history or baseline year, as well as plant output over the same period.

Such billing history includes all energy, under any form, consumed at the plant, such as electricity, natural gas or fuel oil. It must be weighed in order to take into account all changes occurring over the period that could have significantly affected energy consumption at the plant. Among such changes we could find, for instance, a major equipment failure or a revamping of the production process at the plant. The billing history may be subdivided by sector or by building, according to available energy meters or submeters. In the event there is no such metering devices in a sector where energy managers wish to concentrate their efforts, it may be beneficial to install a submeter to segregate the sector from the rest of the plant and in this way be able to ascertain its energy consumption. Such submetering may be useful later to provide proper monitoring of energy-related measures implemented in that sector.

Such energy consumption objectives normally lead to the definition of priorities with the emphasis placed first on measures requiring low investments or for which the recovery period is rather short. Measures entailing a greater investment effort or a longer payback period will be implemented at a later date, taking into account any interrelation with, or cascading effect from, previously implemented energy efficiency measures.

The payback period is computed as the ratio between total investments required to carry out the measure and the sum of annual monetary savings made possible by the implementation of it. The payback period sought in the industry is generally below 2 years. There are other methods of computing the payback period which take into account, for instance, loss of production, additional annual maintenance expenditures, depreciation or value enhancement brought to the plant through the installation of new equipment, project financing, interest rate forecasts, impact of a given measure on taxes paid by the company, useful life of new equipment, among other factors.

Criteria other than those of a strictly economical nature may also encourage the implementation of energy efficiency measures within an aluminum smelter. This is the case, for instance, of a plant where there is a requirement to increase production beyond the existing capacity of smelting furnaces or to limit the addition of new equipment due to space constraints. This could

also apply to a plant where part of the aluminum production must be transferred to existing equipment on which heat recovery devices must be installed if we wish to increase production capacity and eliminate the use of obsolete or underused furnaces. Also, the financial impact associated with changes to existing equipment to achieve a higher energy efficiency is often less expensive than installing new equipment.

Finally, criteria such as environment protection or increased workers' safety may in many cases add value to the implementation of energy efficiency measures.

The search for energy conservation actions or measures within a plant calls for an overall vision of components in the manufacturing process and equipment used. Simple energy conservation measures such as installation of insulating material on exterior walls and optimizing the operation of electromechanical equipment in the building such as lighting and room heating are also possible. When carrying out an energy efficiency program within a plant, the corresponding measures may have a ripple effect on the personnel when they are properly implemented and do not interfere with workers' comfort.

In this guide, we deal with some energy efficiency measures that may be considered by aluminum smelters as well as technical concepts that make their implementation possible. It is difficult to quantify the extent of monetary savings or the cost of investments associated with a specific measure since the profitability of each action, which must be the subject of an individual study, is directly related to energy costs incurred by the plant. We believe however that energy efficiency measures outlined in this document may, generally speaking, be carried out beneficially and offer an interesting payback period.

In this guide we start with a presentation of conventional energy efficiency measures as they are implemented in any industrial sector. Later, we deal more specifically with measures applicable to melting furnaces such as optimizing burner placement inside reverberatory furnaces, improved air

tightness of furnace doors as well as installation of heat recovery devices in stacks venting aluminum smelting furnaces.

Finally, this guide provides a brief outline of additional energy efficiency measures that may apply to the aluminum industry.

1.0 CONVENTIONAL ENERGY EFFICIENCY MEASURES

Several conventional energy efficiency measures encountered frequently in an industrial environment may be applied to aluminum smelters. The most common are presented here, namely conversion from one form of energy to another, control of electrical demand, replacement of a standard efficiency motor with a high-performance motor, installation of variable speed drives on motors, optimization of the operation of compressed air and ventilation systems as well as installation of insulating material.

This is not a comprehensive inventory of conventional energy conservation measures but rather a means to highlight basic concepts that can be used to reduce energy consumption at the plant.

1.1 CONVERSION FROM ONE ENERGY FORM TO ANOTHER

Conversion from one form of energy to another may be considered after comparing the performance of each of the energy forms available as well as their corresponding cost for a given application.

Companies such as Hydro-Québec and Gaz Métropolitain may offer grants, rate rebates or outright payments for part of the cost of comparative studies or, in some cases, conversion work. We are suggesting that they be consulted and that you keep yourself informed of all available conversion assistance programs.

The basic components of energy billing rates as used by these companies must be well understood. For instance, in terms of electricity consumption, demand power, power factor and penalties are all concepts that need to be understood. It is equally important to properly understand the concept of the winter billing period, which runs from December 1st to March 31st, and during which maximum monthly

electrical demand has an impact on the client's subscribed demand and often involves the application of a winter premium rate.

With respect to natural gas, focus must be on gas and transport pricing, daily consumption volume, subscribed volume as well as the various premiums and rebates. The last few years have seen the emergence of natural gas brokers who make it possible to negotiate the final cost of natural gas.

With respect to fuel oil, conversion of a natural gas burner to a hybrid burner (fuel oil/natural gas) may make room for lower penalties associated with the rate for an interruptible supply of natural gas.

Other resources such as consultants may be called upon to determine the impact of a conversion measure on rates and energy supply contracts entered into with these companies or with a broker.

Even though electricity rates in Quebec are usually higher than those for natural gas or fuel oil for furnace heating applications, the use of electricity may, in some cases, be beneficial and make it possible to do away with other expenses given the fact it is clean, most flexible and has high available energy density. Electrical resistance heating with almost 100% yield may bring one or more technical benefits leading overall a more rational use of energy at a lower cost, just like electrical induction heating, although less efficient.

In other instances, despite performance levels in the order of 70% to 75% achieved with a device using natural gas, the replacement of electrical equipment by new natural-gas-operated equipment makes it possible to decrease power demand at peak time and thus lead to an interesting payback period.

1.2 CONTROLLING ELECTRICAL DEMAND

Controlling peak electrical demand at a plant may prove to be a most profitable energy efficiency measure. Often, such peak demand may account for approximately 50% of monthly billing and it is important to attempt to bring it down as much as possible.

For instance, a most simple measure, most often at no direct cost, is to defer operating some pieces of equipment until the end of peak power demand time at the plant. Often such measure requires only an analysis of billing for electricity at the L rate by Hydro-Québec to determine the plant's peak period along with identification of major equipment having an impact on such maximum power demand. In other instances, there may be a requirement to install a temporary recorder at the plant's electrical entry to monitor the power demand profile over a given time period and measure actual amperage of equipment to determine which equipment could be operated outside the peak demand period.

Another measure that may be considered is to rotate or cycle loads during peak electrical demand periods. Such cycling should not however interfere with plant production and may require the addition of equipment for device control.

1.3 REPLACING AN EXISTING MOTOR WITH A HIGH-PERFORMANCE MOTOR

A high-performance motor is a three-phase induction motor with a performance greater on average than that of standard motors. This more effective motor type owes its high performance to better materials and improved design, which translate into lower losses. Generally, its distinctive manufacturing traits are as follows:

- Thinner stator blades made of higher quality steel;

Conventional Energy Efficiency Measures

- A higher percentage of copper in windings;
- A narrower gap between the rotor and stator;
- Lower friction bearings;
- Reduced ventilation losses;
- Closer machining tolerances.

Replacing an existing motor with a high-performance motor makes energy conservation possible through a reduction in the power rating (kW) and the amount of electrical energy consumed (kWh). This may also contribute to improving the plant's power factor in some instances. The profitability analysis dealing with replacement of an existing motor with a high-performance motor represents an opportunity to check the actual power requirement of such equipment, which is often too high. Most industrial facilities use oversized motors in order to protect themselves against motor failures, have the opportunity to increase production and be able to handle load variations. They must pay the price for such security through a low performance achieved from motors.

The chart below shows that a high-performance motor is generally 3% to 8% more efficient than a standard motor.

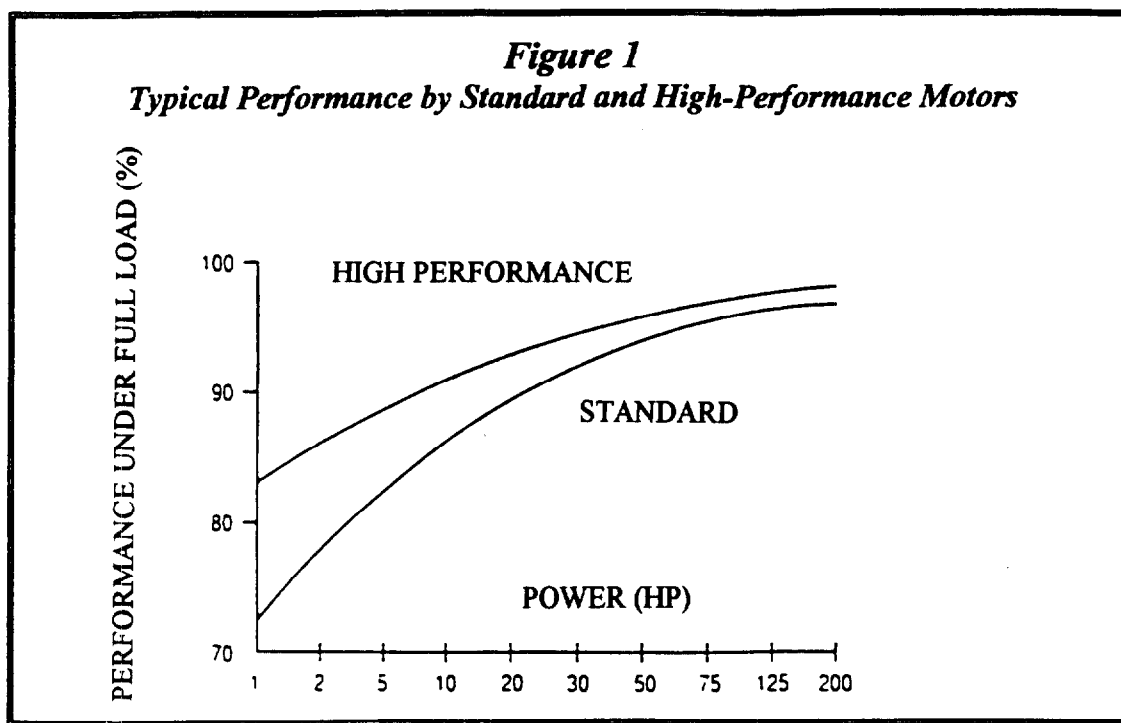

In a plant, the portion of the electricity bill devoted to driving motors may be quite significant. Quite often, a defective standard motor is replaced in a systematic fashion with a high-performance motor given its high impact on peak electrical demand. It is quite often difficult to justify replacing a well running standard motor with a high-performance motor. It is more profitable to wait until the rewinding or replacement of a standard motor is needed to install a high-performance motor. The profitability of the decision becomes then interesting taking into account the additional marginal cost rather than the full cost of such type of motor.

For instance, replacing a standard motor with a 100-hp high-performance motor operated 4,000 hours per year at Hydro-Québec's L rate would yield annual savings in the order of \$500.00 with a price differential between the two motor types in the order of \$700.00. The additional cost associated with the purchase of a high-performance motor would be recovered in less than 2 years.

1.4 INSTALLING A VARIABLE-SPEED DRIVE (VSD) ON AN ELECTRICAL MOTOR

An alternating current (AC) variable-speed drive is an electronic power system controlling the rotational speed of an alternating current motor through variations in the frequency and the voltage applied as input to the motor. It also regulates output voltage according to output frequency in order to maintain a relatively constant ratio between the two. This allows the motor to develop sufficient torque over a range of speeds. A VSD would therefore allow the motor driving a centrifuge device such as a fan or a pump to adjust flow according to processing requirements. It serves to replace the register in a fan or a pump choker, two devices that often leave the motor running full bore notwithstanding changes in flow requirements. A VSD may also be installed on a direct current (DC) motor. However this calls for different technologies to effect changes in rotational speed for this type of motor.

Variable-speed drives are widely used in most industrial sectors in Quebec. A VSD makes it possible to adjust the motor's power to actual load demand. Since the power varies according to the speed reduction cubed, a 20% reduction, for instance, using a VSD will lead to a reduction in power consumption in the order of 50%. Savings become significant when a VSD is installed within the framework of an application with a high percentage of wide load variations, a high number of yearly operating hours and a high power rating. In the case of the aluminum industry, replacing registers on a remelting furnace stack by installing a VSD on the fan motor may prove to be an interesting application.

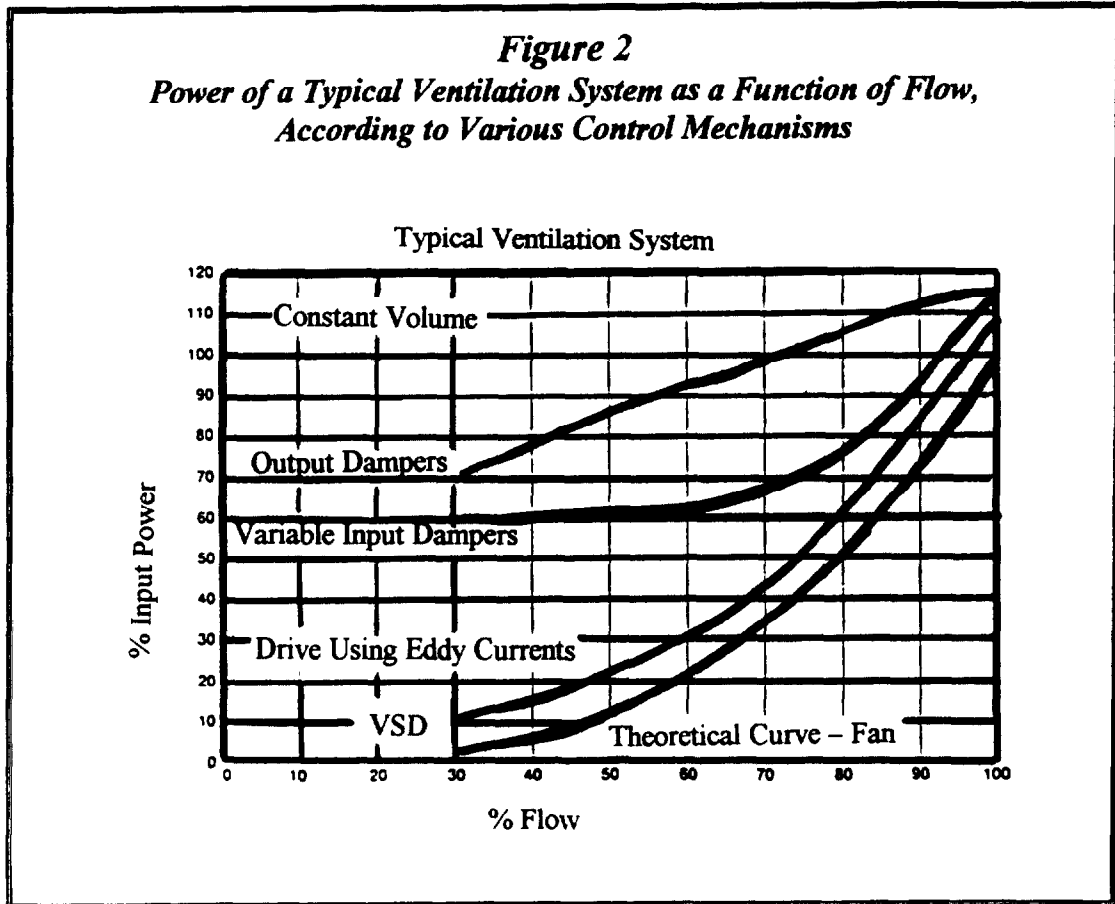

Figure 2 clearly shows power reduction associated with lower load in a typical ventilation system according to various types of airflow controls.

1.5 OPTIMIZING OPERATION OF COMPRESSED AIR SYSTEMS

Examination of the operation of the compressed air systems and networks installed at the plant may also prove necessary and yield notable savings. On a new, well designed, compressed air network, losses in the order of 5% may be expected. Tests conducted at many Quebec-based facilities show compressed air losses in the range of 20% to 40% and averaging 30% of compressed air produced in the existing network. This constitutes a good potential for energy savings. Energy

efficiency measures the most often implemented on compressed air systems are as follows:

- Addition of dew point controls on air dryers instead of having a fixed drying cycle;
- Reduction of significant compressed air leaks on distribution networks. It is not rare to find that once leaks are terminated, it is possible to stop one compressor running;
- Addition of automatic bleed devices with no compressed air loss at egress from cooler and at compressed air tank;
- Substituting the use of compressed air to cool hot surfaces by installing low-pressure fan assembly;
- Optimization of control methods;
- Changing the fresh air intake on compressors;
- Management of compressor operation according to individual performance;
- Adding venturi nozzles on hoses used for equipment cleaning.

1.6 OPTIMIZING OPERATION OF VENTILATION SYSTEMS

Ventilation systems installed in plant buildings may also be examined in order to determine if they are operating in optimum conditions. Often these systems are poorly maintained and operating costs are underestimated. Also these systems may impact on production quality and the comfort of personnel. Energy efficiency measures most often implemented for ventilation systems are as follows:

- Replacing register-based airflow controls with variable-speed drives on fan motors;

- Optimizing static pressure inside ventilation ducts and modifying connectors at the fan's entrance and egress. Often ventilation systems have tight or square elbows installed in ducts before and after fan locations. Such configurations generate significant vortex conditions at the fan entrance and drastically affect performance and efficiency as compared to manufacturer's data. Performance drops in the order of 15% to 30% have been measured on poorly configured venting facilities. This limiting behavior attributed to a deficient design or installation of ventilation systems is referred to as the "system effect";
- Adding a progressive starter on all fans operated on a repeated stop-start basis;
- Introducing computerized management of ventilation systems operation in order to monitor operating times, set points, alarms, etc;
- Replacing fittings on exterior air registers as well as frequently adjusting register blades and actuators.

1.7 INSTALLATION OF INSULATING MATERIAL

Another energy efficiency measure deals with the installation of insulating material on pipes and ducts. Insulation helps maintain a controlled temperature for process liquids carried from one point to another. It also helps protect personnel against extreme equipment temperature and, in so doing, increase their comfort level.

For all these reasons, it is important to select the proper type of insulating material as well as determine its optimum thickness for a given process application. These are two aspects that are the subject of studies in the process of searching for maximum energy efficiency in a plant. The same goes for high-performance insulation of furnaces and major process heating equipment.

Special attention must be paid to those parts of steam piping that are not usually insulated, such as valves and other fittings, for which maintenance access must be provided. For such locations, it is possible to obtain removable insulation jackets, usually secured with Velcro attachments, which can limit heat dissipation without interfering with access to equipment.

Energy Efficiency Measures Specific to the Aluminum Industry

2.0 ENERGY EFFICIENCY MEASURES SPECIFIC TO THE ALUMINUM INDUSTRY

As previously mentioned, this section shall deal most specifically with energy efficiency measures relating to the optimum positioning of burners inside reverberatory furnaces, improving furnace air tightness as well as installing heat recovery devices on melting furnace stacks.

2.1 OPTIMIZING BURNER POSITIONING TO ENHANCE HEAT TRANSFER IN REVERBERATORY FURNACES

Scant data are available on the ideal location of a burner inside a furnace. Location is determined for each facility and is dependent upon various parameters such as location of furnace doors and location of flue ducts. Most relevant information will be obtained from burner manufacturers who may select the best burner type for a given furnace, simulate operation in an existing furnace and determine performance. Burner manufacturers are generally knowledgeable as to the specific aspects of aluminum production and offer burner types suitable for such applications. Information may also be gathered from furnace manufacturers as well as from consultants in the field of industrial combustion.

In most cases, energy savings derived directly from a relocation of burners within a furnace may prove difficult to quantify. The impact of such measure on furnace performance and production capacity is an important benefit in achieving the plant's objective for efficient energy consumption.

We however note that for all combustion-based processes, priorities among measures to be implemented within a plant are often classified as follows, in order of decreasing importance:

Energy Efficiency Measures Specific to the Aluminum Industry

- Proper tuning of burners on the basis of flow regulation, air pressure and excess air;
- Decreasing furnace heat loss through insulation or caulking, reduction in the size of openings and repair of cracks;
- Repairing or modifying burners;
- Adapting heating power to actual aluminum load through automation or addition of controls to vary heating rate;
- Conducting preheating of aluminum load through a lengthening of furnaces (when physically feasible);
- Recovering energy to preheat combustion air fed to the burner;
- Rebuilding or major changes to furnace to increase its efficiency.

It is to be noted that, when such priorities are drawn, the achievement of an energy consumption objective is closely associated with improving the furnace energy efficiency as well as efficiency of combustion in burners. Taking into account the aluminum production process in the furnace, its energy efficiency is dependent upon several factors but mainly overall dimensions, age or condition of furnace, construction quality of its hearth as well as materials used and total area of openings.

For its part, combustion efficiency of the furnace burners is directly related to combustion attributes derived from chemical parameters such as excess air or conversely the lack of air which induces the loss, in escaping flue, of potential energy not released from unburned combustion gases, in addition to remaining latent heat. The temperature of combustion gases at furnace exit and temperature of combustion air at burners are the main physical parameters to be considered when assessing overall efficiency in a process furnace.

Energy Efficiency Measures Specific to the Aluminum Industry

Combustion may be defined as a chemical reaction in which an oxidant reacts quickly with a fuel to release its stored thermal energy, in the form of high-temperature gases. When reaching its theoretical optimum form, such reaction is referred as stoichiometric combustion. It occurs when the theoretically required quantity of oxidation reactant, in the form of oxygen from the air or an oxygen-based gas mixture, is added to a given fuel.

However, such theoretically perfect combustion is impossible to achieve in a commercial type combustion device in which the air-fuel mixture is never in perfect proportions. This is why in practice an additional quantity of air, referred to as “excess air”, is added to ensure that combustion is complete. Such additional air varies according to several factors and amounts to approximately 10%. Excess air may also vary according to the variation in heat production required from the furnace burner. Generally, in a burner operating at less than full capacity, it is more difficult to achieve an adequate air-fuel mixture. This is why excess air percentage is increased for lower loads. For instance, a burner requiring 10% excess air at full capacity may use as much as 30% when operating at 25% of capacity. This excess energy consumption used mostly as a safety margin must therefore be optimized and checked on a regular basis in order to ensure sound management of energy consumption in the combustion process.

Combustion quality is measured as a combustion rate which varies according to the percentage of completeness of the chemical reaction between oxygen and fuel components, the rate at which oxygen is added to the fuel in the air-fuel mixture and the temperature maintained in the combustion area.

Energy Efficiency Measures Specific to the Aluminum Industry

Over the past few years, there were several developments in the technology of natural gas and/or oil burners with significant impact in the aluminum industry. Several manufacturers offer low excess air burners in which the proportion of excess air may be as low as 5%.

Typical reverberatory furnaces used in the aluminum industry use heat transfer through radiation from furnace walls and roof to heat the aluminum load. The introduction of heat transfer using a convection technique in melting, heating and holding furnaces often translate into a more efficient energy consumption as well as increased furnace production.

In a summary fashion, thermal convection is defined as a heat transfer mode involving an energy transfer through the movement of liquid and thermal conduction between molecules. Turbulent flows are important in the thermal performance of this heat transfer method. For its part, thermal radiation is the transfer of electromagnetic energy from one point to another. In a radiation transfer, the transfer rate increases quickly as temperature rises.

Heat transfer through convection may be effected by burners that convey part of their kinetic energy to combustion products. Furthermore, the melting process is speeded up since aluminum in its solid state has a thermal conduction ratio higher than it its liquid state. Since the 80's, many furnaces were fitted with convection burners, often referred to as high-velocity burners.

In a well designed conventional aluminum melting furnace with direct loading, location of burners and flame jets creates most efficient heating conditions at the beginning of the melting process. In its solid state, aluminum quickly absorbs heat from combustion products when they come into contact with the metal pile. By

Energy Efficiency Measures Specific to the Aluminum Industry

directing a large quantity of turbulent high-velocity gases onto the cold metal load, flames and combustion gases act as a torch penetrating the pile. As a result, combustion gases exiting the furnace hearth at this stage of the melting process are at a relatively low temperature. Heat transfer by convection is occurring on all surfaces of the aluminum load exposed to the flow of hot gases while heat transfer by radiation occurs only on surfaces of the load that are directly touching the furnace surfaces.

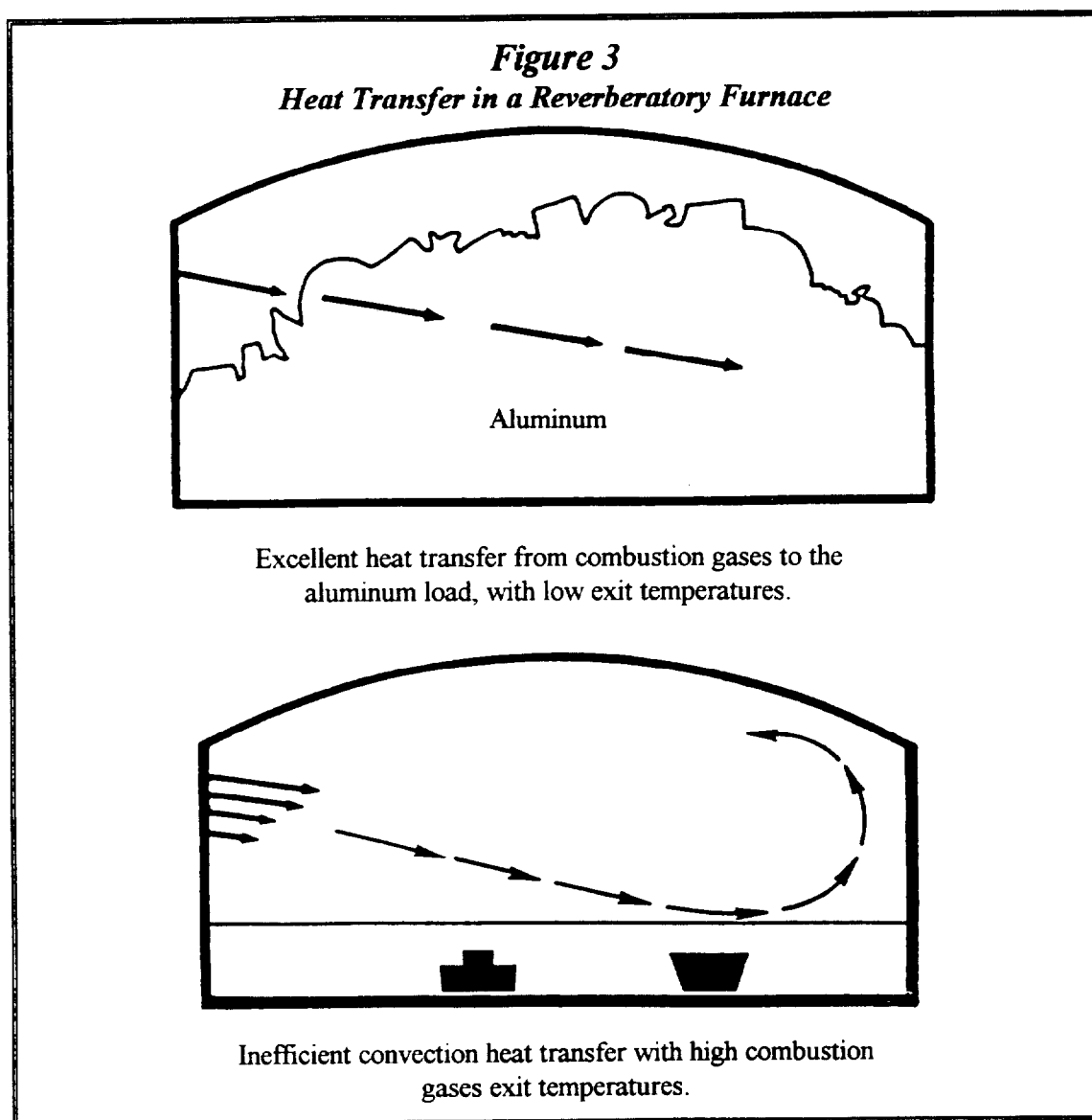

Energy Efficiency Measures Specific to the Aluminum Industry

The increased efficiency achieved with a high-velocity burner is often dependent upon the configuration of the aluminum load. Scrap piles constitute a more open load than a solid ingot and will therefore benefit more from the implementation of this burner type. Partial combustion occurs in the high-velocity burner assembly as well as flame stabilization, which makes it possible to achieve full combustion before the flame reaches the metal bath, thereby reducing metal loss and the formation of scum on the aluminum bath surface.

Temperature of combustion gases increases significantly when the aluminum load starts to become flat and offers fewer solid obstacles to the flame between the burner and the furnace flue opening.

Optimizing the melting process consists therefore in a search for best burner positioning within the furnace and adjusting the flame angle in order to achieve the best possible performance from convection burners. These are generally located lower within the furnace, with a downward flame angle aimed directly at the aluminum load whereas conventional burners are installed horizontally, in the upper part of the furnace.

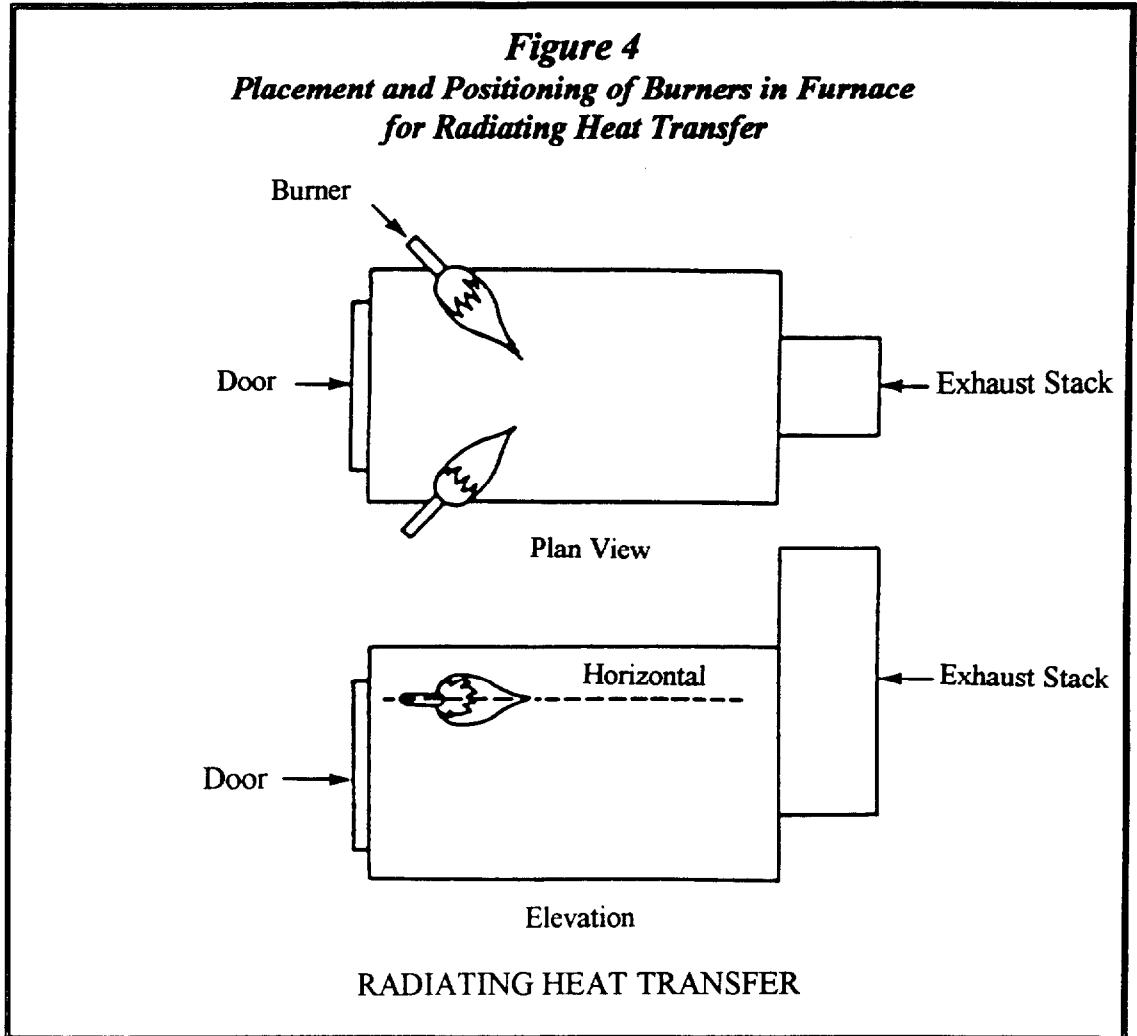

Energy Efficiency Measures Specific to the Aluminum Industry

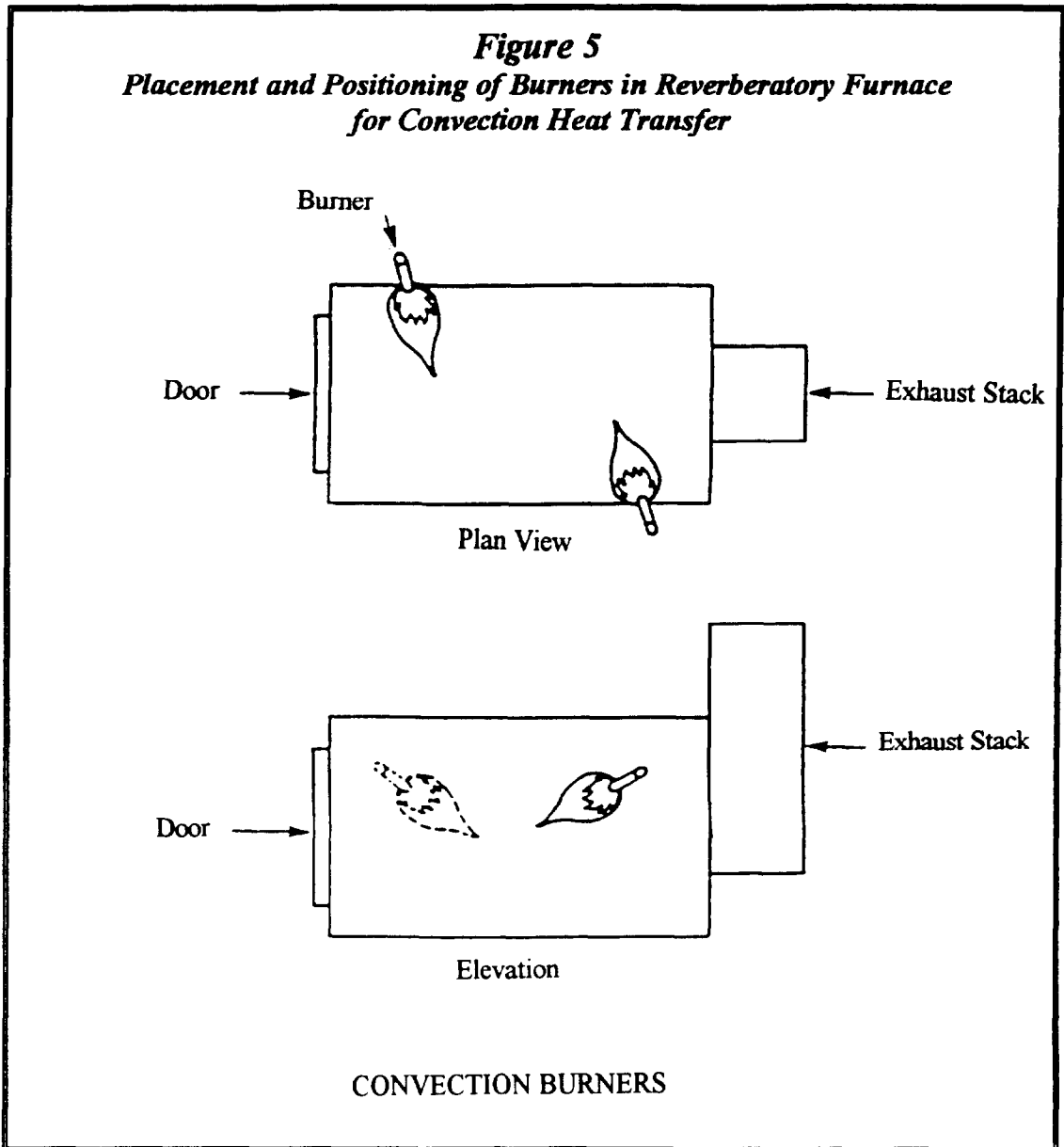

Benefits derived from convection burners turn however less significant when the molten aluminum load settles as a bath with a relatively flat top surface. However, even when this occurs, the flow of combustion gases over the surface of the molten aluminum bath decreases its surface tension, which makes for an improved heat gradient, as compared to the presence of radiating heating, because of more uniform temperatures within the furnace.

Energy Efficiency Measures Specific to the Aluminum Industry

Several studies have shown that the use of convection burners leads to a smaller furnace wall and roof area due to the reduction in radiating heat transfer. Also, since the temperature of combustion gases is lower, heat loss through its components is reduced without noticeable change with respect to metal loss during the melting process. Since temperatures of refractory areas are lower during melting, the useful life of the refractory lining tends to increase with attendant reduction in costly refractory repairs, including production downtimes.

Also, combustion gases generated in the furnace and vented through the exhaust stack represent an important source of pollution with pollutants that may be classified into four (4) categories, namely:

- Products of incomplete combustion of fuel such as smoke, soot, organic compounds, carbon monoxide (CO) and gaseous hydrocarbons;
- Nitrogen oxides (NO_x);
- Emissions resulting from fuel contaminants such as sulfur oxide (SO_x), ashes and some trace metals;
- Emissions resulting from additives associated with the combustion process.

Control of such emissions is regulated and the issue has been hotly debated. Within the framework of this guide, we will only look at NO_x, which are gases forming during combustion at high flame temperatures, namely above 1090 °C. The NO_x abbreviation includes NO and NO₂, NO reacting with oxygen (O₂) contained in the air to form NO₂ and ozone (O₃), the process being accelerated by the presence of sun rays and some volatile organic compounds present in the atmosphere. NO₂ is one of the causes of photochemical smog and acid rain and, because of this, a severe environmental pollutant which is hazardous to health and must be controlled, such as is ozone which, when present at ground level, may impair the breathing function.

Energy Efficiency Measures Specific to the Aluminum Industry

Generally, the main parameters being considered when analyzing atmospheric emissions of NO_x from the furnace are the burner type and its heat jet pattern, the heat ratio in the furnace in relation to hearth size, time during which combustion gases are retained, placement of the aluminum load in relation to the flame, type of refractory construction as well as air leakage through existing openings in the furnace. Mechanisms for controlling NO_x emissions bear mostly for a given fuel, on peak flame temperature, limit oxygen concentrations within the flame and combustion time at peak temperature. These latter parameters are added to an overall study of furnace components with respect to its design, construction, maintenance as well as the total environment and combustion process.

Proper in-furnace combustion quality is essential to heat production. Combustion quality will have a direct impact on energy efficiency and on restricted emission pollutants such as NO_x. In order to achieve proper combustion quality, the first requirement is to select an adequate burner. However, once this burner has been installed within a furnace, its attributes become integrated into those of other furnace components to create an overall picture. Burner construction, heating capacity, level of possible flame variation, location and installation within the furnace are major points to be defined to achieve proper combustion efficiency. The number of burners used in a given furnace is often determined so as to produce uniform temperature within the furnace and obtain a range of heat production capabilities.

2.2 IMPROVING AIR TIGHTNESS IN FURNACES

Energy efficiency as regards air tightness of furnaces used in the aluminum industry begins with an analysis of sound management of furnace door openings and closings, in conjunction with production constraints. Costly additional replacement of equipment can sometimes be avoided by simply ensuring that the number of

Energy Efficiency Measures Specific to the Aluminum Industry

furnace door actuations, and duration of each, are reduced to a minimum. Such management often proves most profitable and must be considered even before so simple and obvious a measure as sealing furnace openings. Other energy efficiency measures may later be implemented in order to attempt to decrease heat losses in furnaces.

In order to improve furnace air tightness, several parameters need to be ascertained such as optimum in-furnace pressure, furnace draft and such other phenomena associated with pressure differentials between air, fuel and combustion gases as they travel through the furnace and other facilities.

Several types of drafts can be found in a furnace. Draft may be forced through addition of air or fuel to create positive pressure in the combustion chamber. It can also be natural or induced through negative pressure at furnace egress. Such negative pressure coax combustion gases to leave the combustion chamber through a chimney effect. Finally, draft may be mechanical through the working of chimney fans and other equipment

Pressure within a furnace is referred to as “positive” when it is greater than atmospheric pressure. A positive pressure has the drawback of thrusting in-furnace heat towards doors and other openings, thereby increasing furnace maintenance costs due to degradation of door fittings due to heat exposure. On the other hand, negative pressure has the drawback of adding to excess air fed to the furnace burner, thus reducing its efficiency and triggering partial cooling of the aluminum load, temperature differentials within the furnace and in the molten metal bath as well as introducing an undesirable oxidation agent. However, a negative pressure is safer for personnel working in the furnace proximity. Achieving a neutral pressure within the furnace is the ideal condition but one that is difficult to maintain. A

Energy Efficiency Measures Specific to the Aluminum Industry

compromise solution is to maintain a balance of pressure within the furnace in order to optimize production benefits and reduce inconvenience to personnel and equipment. The trend is therefore to keep a slightly positive pressure within the furnace.

Several methods may be used in order to maintain a pressure gradient within the furnace, from a positive pressure in the top portion of the furnace, a neutral pressure at the level of manually operated doors and a negative pressure in the lower portion of the stack. Such negative pressure is achieved through a variable resistance from such mechanisms as motorized dampers or variable-speed drive on the stack exhaust fan. Operation of such mechanism is generally coordinated by an automated device with feedback from other parameters, including, primarily, the burners' operating sequence. Other secondary factors such as pressure within the building, the effect of wind on chimney draft and the leakage of air by equipment may influence how pressure maintained in the furnace is controlled.

The energy loss due to air infiltrations is difficult to quantify and calls for a specific study related to a given furnace. Factors such as the size of cracks and their placement in the furnace as well as the number of times furnace doors are opened must also be taken into account. Many users of older furnaces attempt to compensate the air-fuel mixture at the burner in order to adjust the mixture's richness and use infiltrated air as additional oxygen source, thereby diminishing its negative impact on combustion performance. Excess air at the burner may often then be corrected through analysis of the percentage of oxygen present in combustion gases originating from a given furnace.

Air infiltrations caused by a negative pressure in those areas of the furnace containing openings may have a significant impact on NO_x emissions by interfering

Energy Efficiency Measures Specific to the Aluminum Industry

with levels of excess air in the system and providing additional available oxygen to the burner, leading to the formation NO_x . Such air is then mixing with the flame envelope and thus create high local oxygen concentrations in the hottest zones of the flame. Controlling pressure within the furnace is often an effective technique not only to improve furnace performance but also to limit NO_x production.

Depending on equipment installed at the plant, other measures may be taken into consideration but it is always very important to check both their feasibility and impact on production. For instance, installing equipment that creates a forced air curtain when a furnace door is open may be considered in order to reduce airflow in and out of the furnace. However, equipment available on the market must be suited to the furnace and capable of operation at high temperatures without interfering with the personnel's actions nor impair its safety. Measures of this type are less popular because of the inconvenience associated with their implementation. Figure 6 below shows typical air movement around a furnace door as caused by poor air tightness and deficient pressure control.

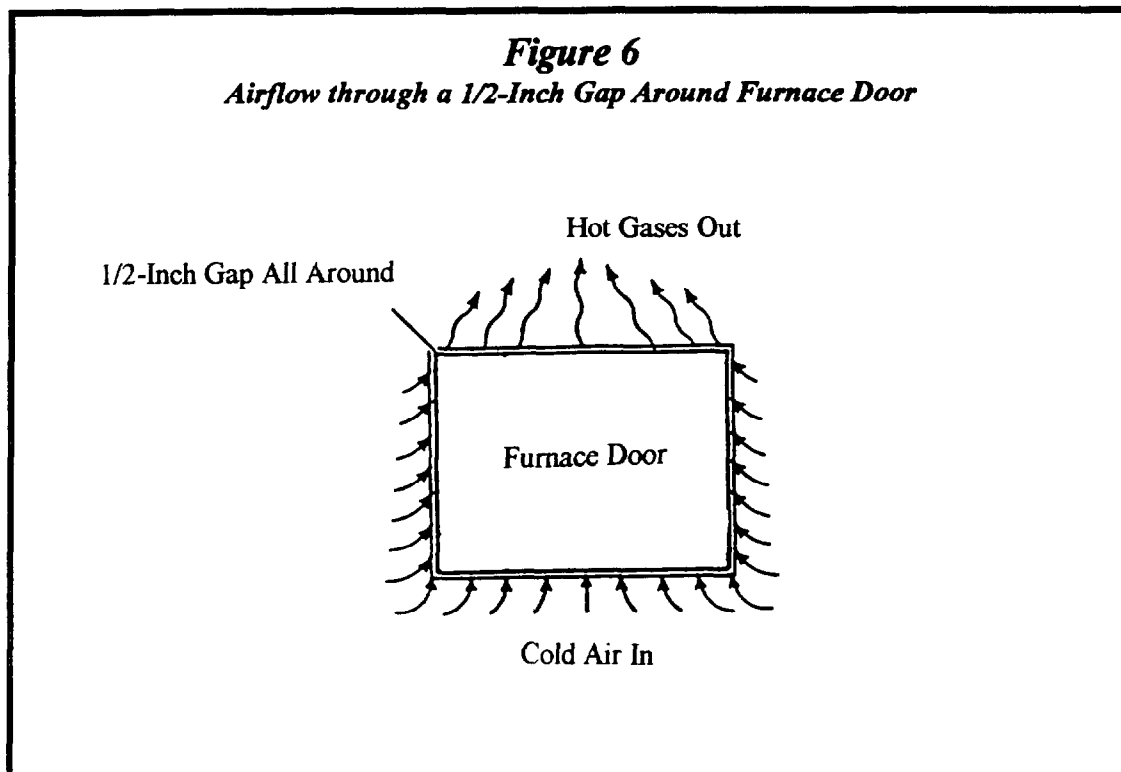

Finally, it is important to check whether the burner has been installed according to the manufacturer's recommendations and ensure it is properly maintained. This is because one of the main causes of burner and furnace failure is refractory expansion and combustion gas leakage in between the furnace outer shell and the refractory lining, especially in the area of burner attachment to the furnace.

2.3 INSTALLING HEAT RECOVERY DEVICES ON EXHAUST STACKS OF ALUMINUM MELTING FURNACES

Hot combustion gases produced in an aluminum melting, holding or alloying process contain a sizeable amount of heat. In order to conserve such energy, it is important to attempt recovering most of this lost heat by lowering as much as

Energy Efficiency Measures Specific to the Aluminum Industry

possible the final exhaust temperature of combustion gases returned to the atmosphere.

This section of the guide deals with the feasibility of a heat recovery process. This project may be defined according to the following three parameters: available heat source, potential placement of the heat recycling point and technical and monetary aspects of the method used for such energy transfer. This section also contains an analysis of potential destinations within the plant for extracted heat and the various concepts found in heat recovery systems available to the aluminum industry.

2.3.1 Heat Source

The heat source available within the plant must contain a significant amount of sensible heat. It may also contain a significant quantity of latent heat, in relation to dew point, that may then potentially increase total recoverable energy. Major parameters in gauging recoverable energy from a heat source are quantity, temperature and quality.

The energy quantity associated with a heat source may be computed through direct measurement of flow and temperature, combined with knowledge of how the medium is made up, such assessment may however be difficult to conduct. It may be arrived at by deduction upon the drawing of an energy usage statement taking into account all heat transfers and flows found as input or output of a process. A sample energy usage statement for a furnace-based process is shown in Figure 7.

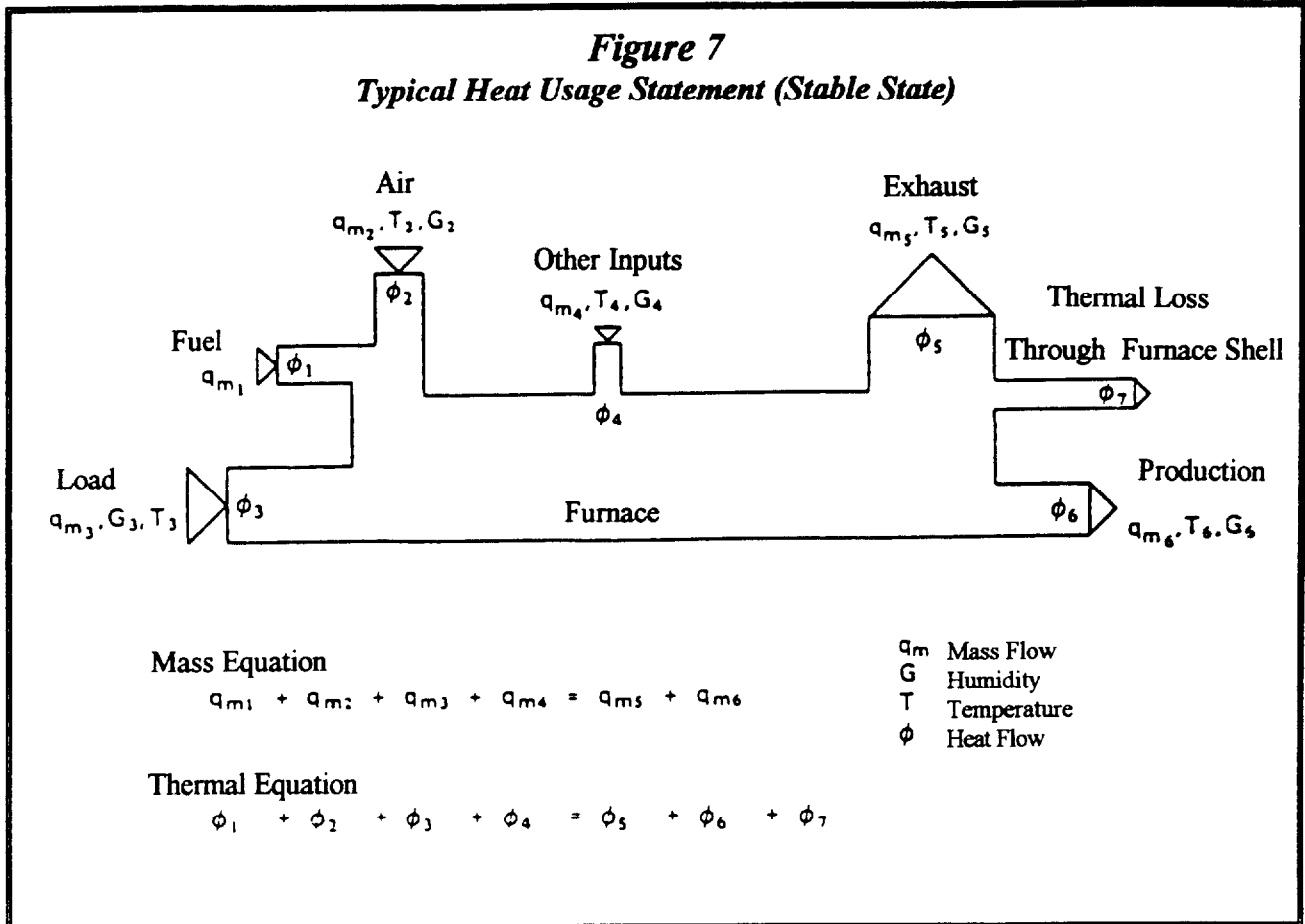

Such an energy usage statement is used to confirm the initial estimated quantification of available heat in the determination of overall thermal efficiency of the process. It may also reveal the priority ranking of heat recovery measures to be integrated into a process. Also, it forces you, at the outset of a heat recovery project, to consider all possible alternatives in order to improve thermal efficiency of the process itself. It is generally more economical to reduce heat quantity used, for instance through elimination of air infiltrations into the furnace, rather than attempt to recover large quantities of excess energy generated in an inefficient operation. It is also preferable to take into consideration a low-cost and more profitable measure such as adjusting excess air to furnace burners before giving consideration to installing a heat recovery device.

Energy Efficiency Measures Specific to the Aluminum Industry

Temperature of the heat source is often the first criterion to be examined in order to determine a project's feasibility. Generally speaking, the higher the temperature in the heat source, the most profitable the heat recovery project.

Finally, quality of the heat source (or lack of it) is usually the main obstacle to implementing a heat recovery project. Examination of the quality of the source deals with all physical and chemical contaminants present in the rejected heat medium, according to available heat profiles. Such contaminants lead to corrosion or clogging of heat exchangers and tend to increase maintenance costs or negate the project's feasibility.

Available heat profiles may be most varied, especially with non-continuous processes. Heat recovery from a steady source is of course more profitable than from a frequently interrupted process or one with wide variations in heat production. It would then be necessary to oversize equipment to handle maximum flow from the source and this tends to increase installation costs and decrease project profitability.

2.3.2 Recovered Heat Reinjection Point

The potential placement within the process of the point where recovered heat is reinjected is as important a criterion as availability of its source. The quantity of heat that may be recovered is normally directly proportional to the temperature differential between the source and destination of recovered heat.

The main problem associated with the desirability of the reinsertion point resides in the heat demand profile. It would be best if such profile would be as close as possible to available heat production. Heat recovery is a most interesting process in the instance where available heat is reused in the same process where it comes from. In all other cases, an analysis and comparison of similarities between heat

Energy Efficiency Measures Specific to the Aluminum Industry

production and recovery profiles must be carried out and will lead to the proper selection of equipment required for optimum and efficient operation.

Other considerations may be beneficially examined to improve the profitability of an energy efficiency project based on heat recovery, when it is possible to store excess energy from a heat source for later reuse in the same process.

2.3.3 Technical Considerations of Heat Recovery

Most aspects of a heat recovery project are determined through an analysis and comparison of the coincidence of production and recovery profiles as in the following design criteria:

- Possibility to isolate or bypass, either manually or automatically, the heat recovery equipment in order to allow for maintenance, according to production criteria (for instance upon production start-up) or for safety purposes;
- Temperatures and pressures involved and controls required for monitoring and safety;
- Controls to operate equipment and interface with existing controls of the production equipment.

Added to these technical design criteria are other conventional technical considerations such as a reduction of heat losses in the recovery system through sufficient insulation, addition of optimized additional motive energy, precautions to be taken to control unwanted condensation and pollutant emissions. It is also important to reduce heat losses in combustion gases upstream from installed recovery equipment as well as heat losses in the medium receiving the recovered energy. The installation of well insulated pipes and ducts is required while keeping pressure loss in the system at a minimum. Special attention must be paid to the

Energy Efficiency Measures Specific to the Aluminum Industry

sizing of ducts and piping in the recovery system in order to take into account decreased combustion gas density downstream from the recovery device as well as the type of insulation selected, together with thickness and installation methods.

To achieve the lowest possible installation and operating costs, the basic requirement is to minimize distance between heat source and reinjection point by keeping as much as possible to a straight line between the two points. To this end, it is often necessary to adopt a compromise solution in order to achieve low pressure loss at the recovery device on the “combustion gas” side, even at the expense of having to add motive power on the “air side”. Such energy is required to create head pressure capable of forcing combustion gases through the recovery device. The cost of this additional energy requirement must be subtracted from energy savings expected from the installation of heat recovery equipment.

A major technical criterion at play in the feasibility and profitability study with respect to installation of a heat recovery system is the determination of the dew point temperature of the combustion gas components. Latent condensation heat contained in combustion gas vapors is an important input of recoverable energy. This additional recovered energy is interesting except where it produces undesired condensation of corrosive liquids that may degrade components in the recovery system. The degree of corrosion resistance of the selected equipment and all its components has a major impact on its initial cost, useful life and maintenance requirements. Formation of non-corrosive liquids may also be a major problem where dirty combustion gases exhausting through the stack lead to the formation of viscous mud in the recovery equipment.

Dew point temperatures in combustion gases vary in direct proportion to excess air at the burner and according to concentrations of O₂, CO₂, SO_x, NO_x and other

Energy Efficiency Measures Specific to the Aluminum Industry

components of combustion gases. To avoid the formation of undesirable liquids, a safety factor is used when computing final combustion gas temperature on the basis of the various dew point temperatures of each of these components. Special attention must be paid to the places in the gas exhaust route where velocity of some of these gases and temperature tend to decrease as well as the section in the stack that protrudes from the building and which will often require to be fitted with insulation material.

With the development of better corrosion-resistant materials such as ceramic, some heat recovery equipment are now designed to deal with condensation and are capable of recovering a greater portion of available latent heat contained in gases. The issue of combustion gas pollution then becomes a problem related to the disposal of recovered liquids.

2.3.4 Potential Use of Recovered Heat

The overall energy efficiency of a typical furnace using a burner fed cold combustion air has not generally exceeded 30%. Approximately 50% to 60% of energy consumed by the furnace is lost in combustion gases escaping through the stack. In this section of the guide, we will see some possible actions to improve energy efficiency through the use of recovered heat, mostly for preheating the aluminum to be loaded in the furnace as well as the combustion air fed to the burner. The opportunity to use recovered heat for other purposes such as heating fluids (e.g. water or building air) is dependent upon existing applications within the plant and must be studied on a case-by-case basis.

Energy Efficiency Measures Specific to the Aluminum Industry

Heat Recovery to Preheat Aluminum Load

Priority towards the achievement of the energy efficiency objective may focus on preheating the aluminum load using the furnace combustion gases. But, this priority may only be established after proper performance of combustion equipment has been verified and the air-fuel mixture has been optimized. It is always implemented by also paying special attention to checking the minimum temperature of combustion gases within the preheating section in order to eliminate the possibility of condensation, which would affect the quality of metal produced and inflict damage to equipment.

Many heat recovery projects have been successfully carried out on aluminum melting furnaces. A project of this type may be initiated after a study with qualified consultants aiming at ascertaining all factors and ultimate feasibility. It may consist in low-cost changes to existing equipment or else it may require more significant investments for the addition of new equipment or revamping of the production line. In some cases, the installation of heat recovery devices or indirect exchangers may make it possible to return a significant portion of the energy contained in combustion gases to the process without these gases ever coming into contact with the aluminum load.

In the case of a continuously loading furnace, as illustrated in Figure 8 below, the addition or extension of a corridor or tunnel without additional heating equipment may be used to preheat the aluminum load coming into the furnace. This results in a decrease in the amount of fuel required to heat the same amount of aluminum.

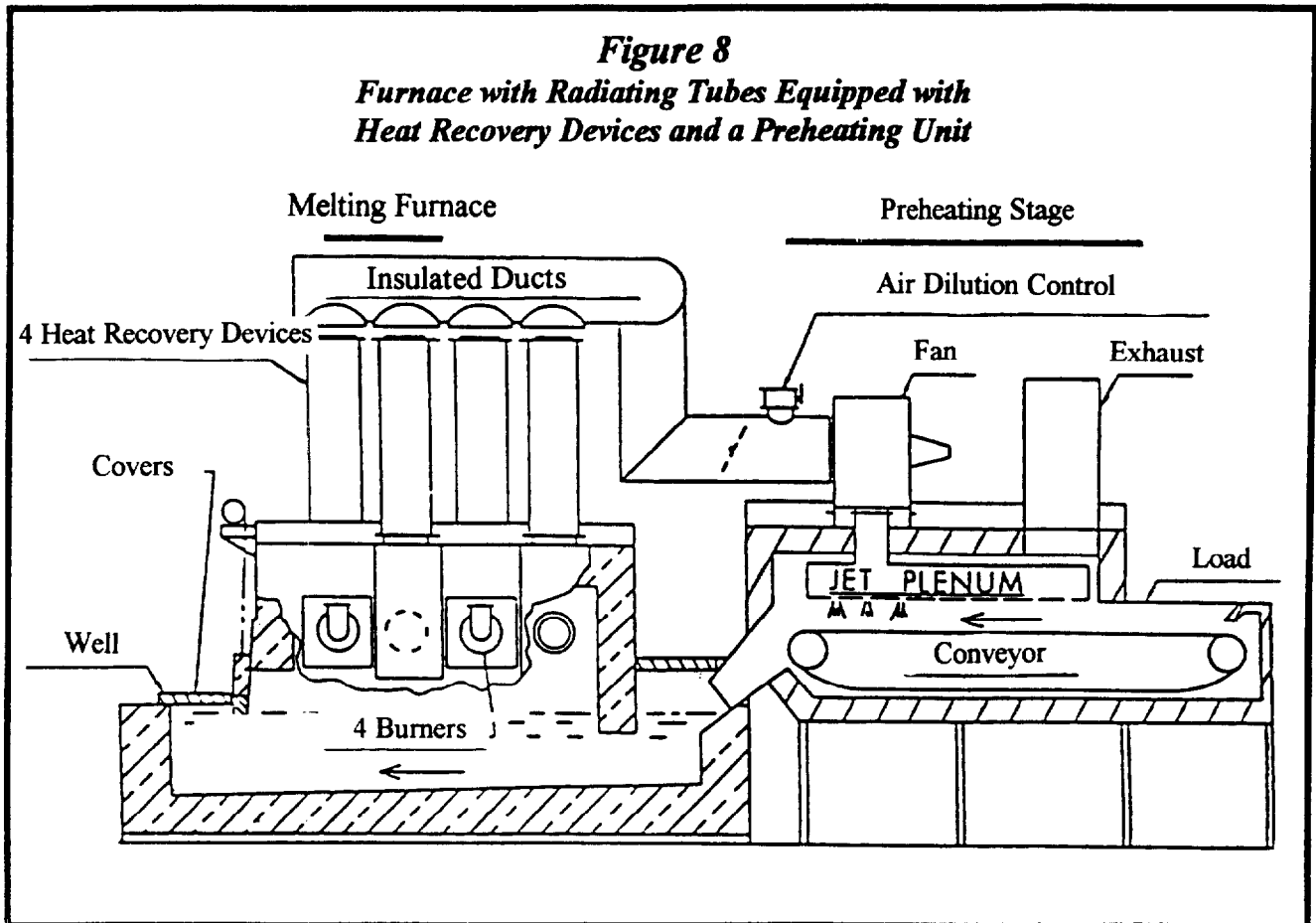

In the case of non-continuous loading furnaces, preheating of the aluminum load may still be possible. However, it may be more profitable to look into changing loading method to make it continuous. Figure 9 shows a preheating furnace built next to a melting furnace and using heat recovered from that melting furnace. The aluminum load must therefore be transferred quickly to the latter to minimize any cooling. Another method that could be considered is the parallel use of two non-continuous loading furnaces in which, where possible, combustion gases from a furnace are used to preheat a new load in the other furnace.

Energy Efficiency Measures Specific to the Aluminum Industry

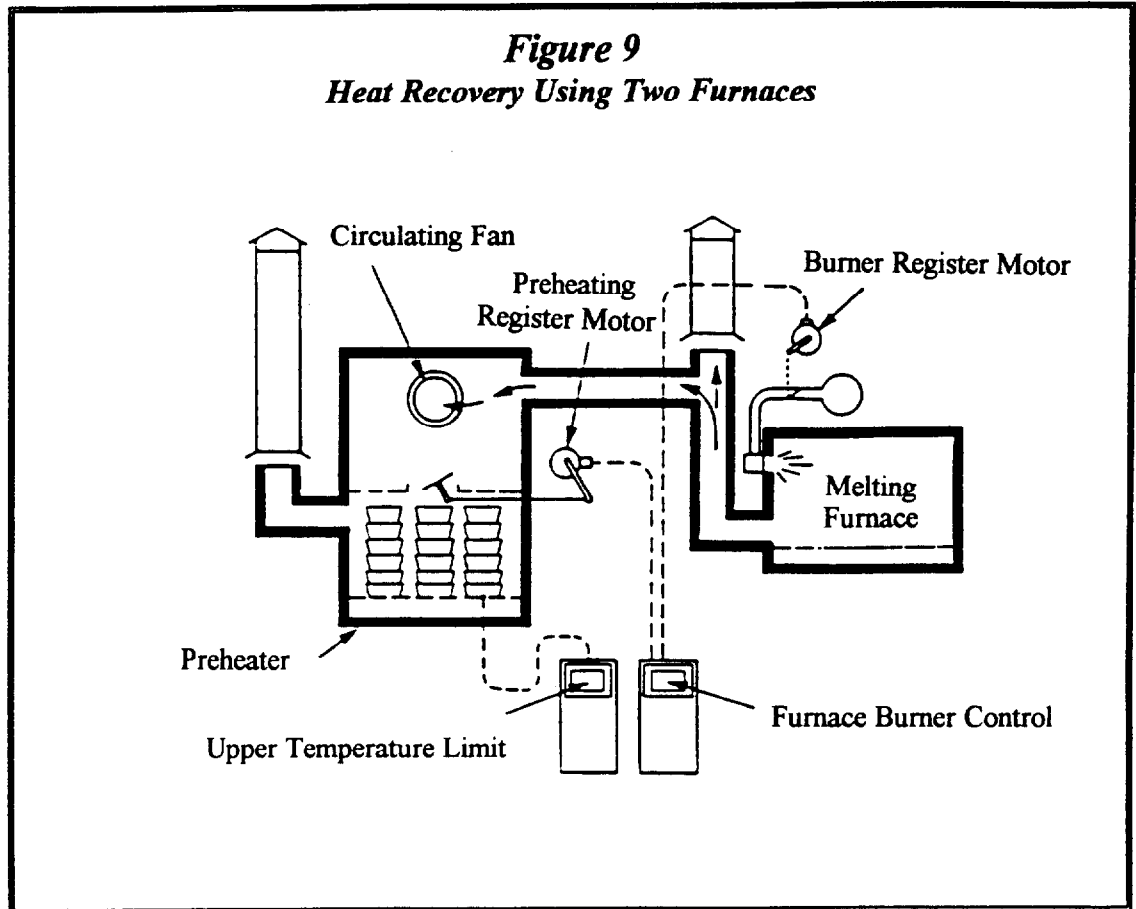

Preheating the aluminum load increases the energy efficiency of the furnace with the added advantage of not increasing flame temperature nor furnace temperature, which, as a result, limits NO_x formation. Proper distribution of heat flow through the preheating zone is an absolute necessity to avoid the localized melting of load or the creation of cool areas with all attendant problems. A heat recovery application may prove simple, without impact on production quality, while making the heating process more energy efficient. In other instances, technical and physical constraints required to not affect production quality may be more onerous.

Heat Recovery to Preheat Combustion Air

Preheating combustion air using heat recovered from combustion gases proves to be an energy measure commonly found within the aluminum industry and is still perceived as the one easiest to implement on a technical level. It also carries a better profitability, primarily in the case of melting furnaces or holding furnaces where major heat losses are through exhaust gases up the duct. As well, profitability of this type of energy conservation is directly related to combustion gas temperature and the percentage of excess air found in the air-fuel mixture fed to burners.

The decision between a metal or ceramic-based heat recovery unit must be made on the basis of gas temperatures and fuel type. Considerable efforts have been expended in research on the manufacture of ceramic-based heat exchangers capable of withstanding high operating temperatures, with better properties in terms of resistance to thermal shock and corrosion, and also easier installation than metal-based heat recovery devices.

Some of the main benefits derived from preheating combustion air are as follows:

- Achieving higher flame temperatures at the burner. For instance, preheating combustion air from 15 °C to 540 °C increases theoretical flame temperature for natural gas from approximately 1950 °C to approximately 2175 °C, which results in improved transfer within the furnace through heat radiating from the flame. Higher air and flame temperatures also contribute to producing a brighter flame further enhancing radiating heat;
- Higher available heat in the furnace and less energy lost in the exhaust stack. The aluminum capacity in either its liquid or solid state to absorb heat from a

Energy Efficiency Measures Specific to the Aluminum Industry

flame with strong radiating heat helps prevent overheating of the furnace walls and roof;

- A higher flame temperature makes it possible to produce a larger quantity of aluminum per hour in a given furnace. Special attention must however be paid by personnel in order to not overheat the metal bath in the furnace. This is because overheating leads to fuel overconsumption and also may increase metal losses and degrade production quality;
- Higher process performance. This may manifest itself though a decrease in the energy required to melt metal or an increased capacity in furnace heating;
- Special attention must be paid to the choking effect on combustion air at the burner when its temperature becomes too high. Such an occurrence may result in an unbalance of the air-fuel ratio;
- In some cases, natural gas may be more competitive than electricity, especially for high-temperature heating applications involving a preheating of combustion air. Conversion to another type of energy may yield monetary savings due to a difference in respective rates.

The major constraints affecting preheating of combustion air is:

- The creation of higher CO levels together with fuel traces in the furnace exhaust as well as higher NO_x levels. These phenomena result directly from a quicker combustion at a higher temperature. They will call for increased monitoring in order to limit their occurrence.

The performance of a heat recovery system is often computed according to one of the following two methods:

Energy Efficiency Measures Specific to the Aluminum Industry

1. The percentage fuel savings is computed as follows:

$$\% \text{ Savings} = 1 - \frac{(\% \text{ Heat Available Without Exchanger})}{(\% \text{ Heat Available With Exchanger})} * 100$$

Table 1 below shows the percentage of fuel savings effected through heat recovery from combustion gases to preheat combustion air at the burner. It is to be noted that all percentage figures are approximate and related to the actual calorific value of fuel used and excess air fed to the burner.

Table 1
Percentage Fuel Saved through
Preheating of Combustion Air

Combustion Gas Temperature (°C)	Combustion Air Temperature (°C)						
	300	400	500	600	700	800	900
600	14	19					
700	15	20	24				
800	16	21	25	28			
900	17	22	27	30	33		
1,000	18	24	29	33	36	38	40
1,100	20	26	31	35	38	40	43
1,200	23	29	34	39	41	44	47
1,300	26	32	38	43	46	49	51

Fuel: Natural gas with 10% excess air

As available heat varies according to fuel selected and the amount of excess air, fuel saving tables published by equipment manufacturers may differ slightly from one source to the next.

Energy Efficiency Measures Specific to the Aluminum Industry

2. Efficiency Ratio (%)

$$\text{Eff. Ratio (\%)} = \frac{(\text{T}^\circ \text{ Air Past Exchanger} - \text{T}^\circ \text{ Air Before Exchanger})}{(\text{T}^\circ \text{ Gases Before Exchanger} - \text{T}^\circ \text{ Air Before Exchanger})} * 100$$

Efficiency may be viewed as the ratio between the actual rise in the temperature of combustion air through the exchanger and the theoretical maximum rise in temperature that could be achieved. Such theoretical maximum could be achieved if air became as hot as combustion gases. However, since this is impossible under the laws of thermodynamics, efficiency will always be less than 100%.

2.4 HEAT RECOVERY SYSTEMS

In industrial combustion processes, there are two main heat recovery methods, namely heat exchangers and heat regenerators. These two types of devices capture the energy contained in combustion gases and recycle it into the process, most often for the purpose of preheating combustion air.

A heat exchanger is a device in which both hot and cold fluids circulate simultaneously, separated by a physical barrier or partition. In this type of equipment, hot and cold fluids never come into contact. A heat regenerator is defined as a heat storage device with capability to return it to the process. A heat regenerator typically operates with a storage cycle and a release cycle.

2.4.1 Heat Exchangers

Heat transfer in a heat exchanger is normally used to preheat combustion air. It takes place through a partition separating combustion air and combustion gases

Energy Efficiency Measures Specific to the Aluminum Industry

The energy saving achieved is often in the order of 30% when combustion air is relatively cold. Heat exchangers offered on the market present a wide selection in terms of size and operating temperature range as well as a good availability of compact and efficient models. This is a proven technology which is widely recognized in the process heating industry. Heat exchangers may be designed to operate with parallel or opposite flows or a combination thereof.

Heat exchangers may for all intents and purposes be divided among two types, namely the radiating type and the convection type. This classification refers to the dominant heat transfer mode from combustion gases through the partition of the exchanger. It is to be noted that because of the very nature of this heat transfer type, recovery through convection will generally be used with combustion gas temperatures lower than 1,000 °C, and radiating recovery at temperatures above this threshold. Some hybrid exchanger models are also available and take advantage of heat transfer using both radiation and convection.

The radiating type heat exchanger is often of a large size with low pressure loss on the combustion gas side. It has a light structural design and is capable of processing gases at temperatures ranging from 1,200 °C to 1,300 °C. Its construction is generally comprised of two ducts installed one inside the other and the exchanger is inserted through replacement of a section in the existing exhaust stack of the furnace.

The air combustion temperature at exit from the exchanger may be as high as 650 °C and varies mostly according to combustion gases temperatures and combustion air flow in the burner. A fan must often be added in order to obtain forced air when pressure drop is greater on the combustion air side of the

Energy Efficiency Measures Specific to the Aluminum Industry

exchanger. Recovery efficiency may reach 40% depending on parameters found in the heating application.

Figure 10
Radiating Type Heat Exchangers

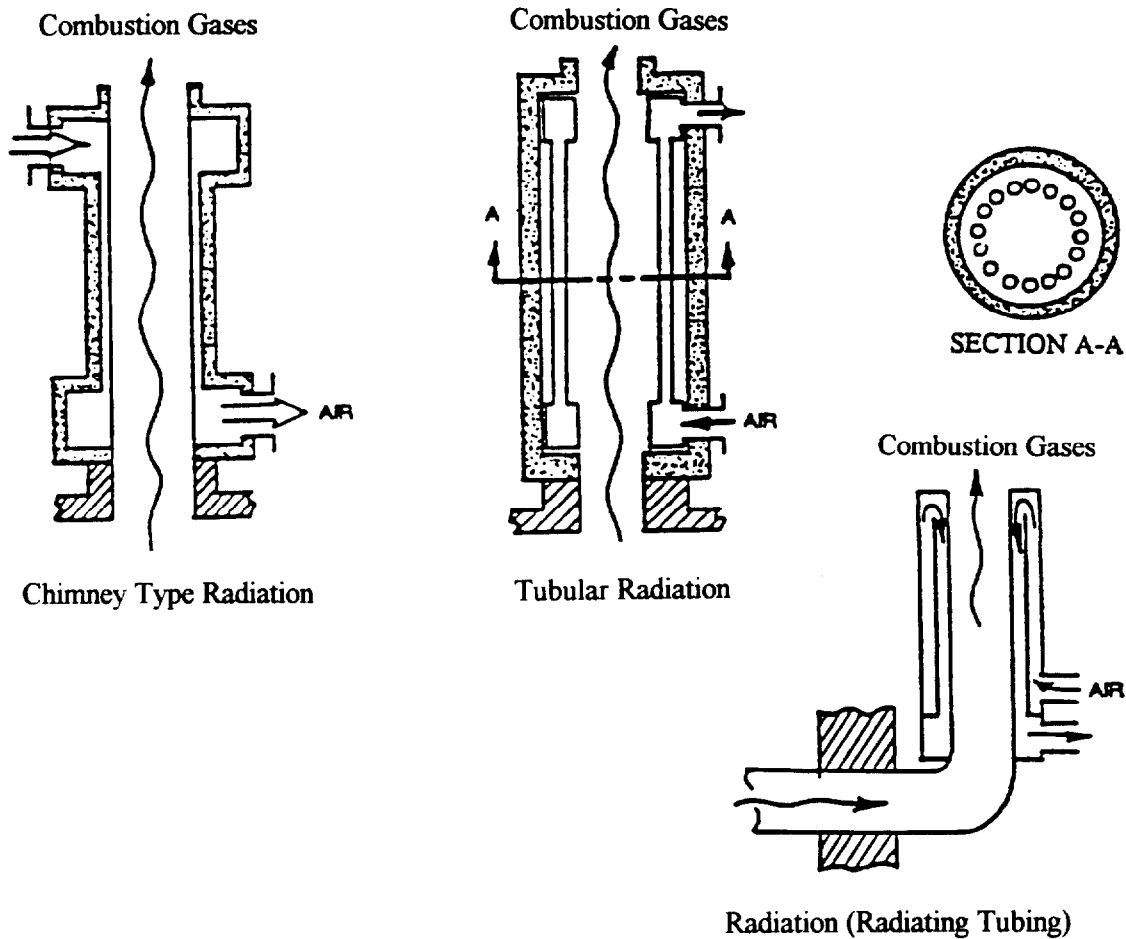

A radiating heat exchanger is recommended for high-temperature applications such as aluminum melting. For the most part, these exchangers are designed with parallel flows in order to prevent overheating at the entrance of combustion gases into the exchanger. An overheating protection mechanism is often installed in the exchanger

Energy Efficiency Measures Specific to the Aluminum Industry

and its operation is generally controlled by an in-exchanger thermocouple. When there is a risk of overheating, the system generally reacts by admitting additional air to dilute hot gases in the admission duct or by purging part of the preheated air at exit of the exchanger in order to maintain sufficient flow. Other types of safety controls are available and are often integrated into the control system.

Several manufacturers recommend that exchangers made of stainless steel not be used when chlorine is added to the molten aluminum bath. This calls for the installation of a bypass duct along the exchanger and the addition of registers. To eliminate the risk of damage, precautions must also be taken to prevent backflow into the exchanger when combustion gases exit through the bypass duct.

The second type of exchangers involve mostly heat transfer through convection. The efficiency of a convection type exchanger varies according to the level of turbulence, velocity and viscosity of fluids flowing through it.

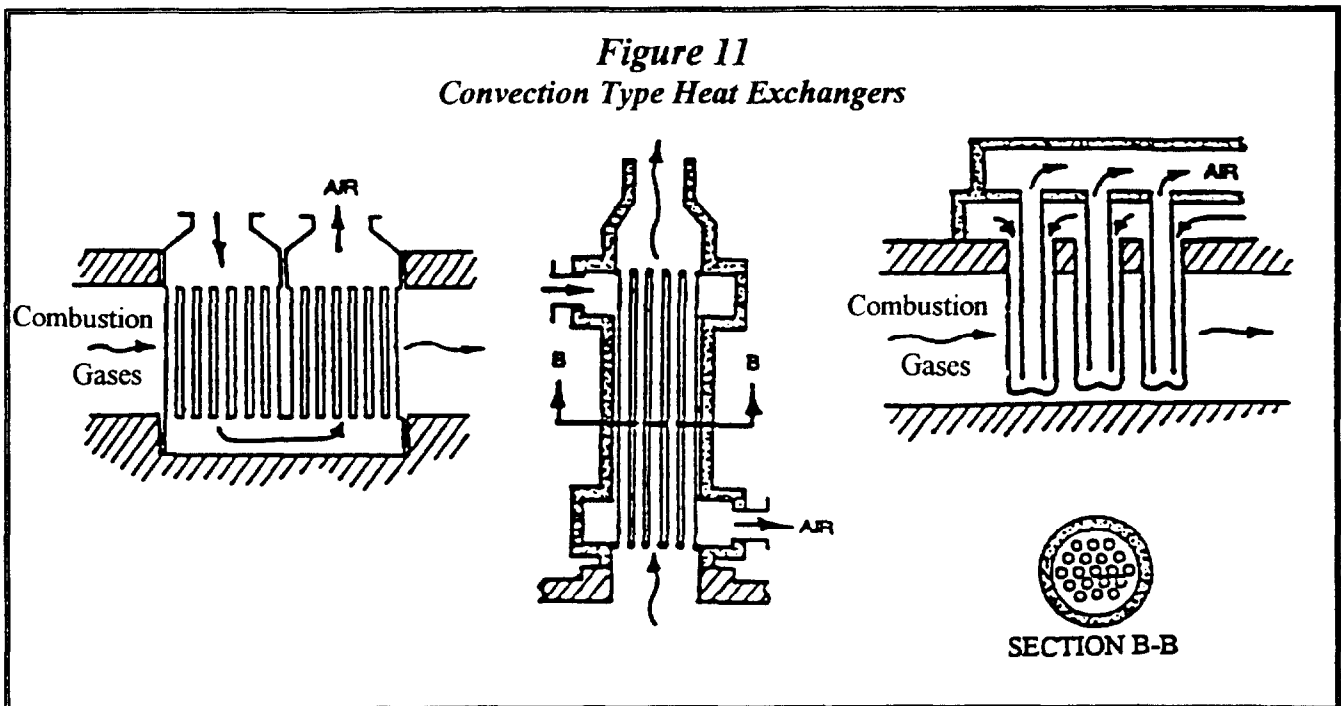

Energy Efficiency Measures Specific to the Aluminum Industry

The convection type exchanger is also of a large size with pressure loss on the combustion gas side greater than in a radiating type exchanger. Its design is generally more complex and it can handle gases at temperatures up to 1,000 °C. Combustion air temperature at exit of exchanger may reach 540 °C dependent upon combustion gas temperature and combustion airflow to the burner. Recovery efficiency may be in the order of 30% and several models are available. They are usually fabricated from steel alloys and some ceramic models may also be available. Generally, combustion gases circulating through this type of heat exchanger must be clean. The convection type exchanger may also be equipped with an overheating protection mechanism involving air dilution or purging, according to the application. Often, a fan is added to compensate for loss of pressure in the exchanger on the combustion air side. The most frequently used exchangers in this category are of a tubular type or plate type. Several configurations are available and this type of exchanger may be installed vertically, horizontally or at an angle.

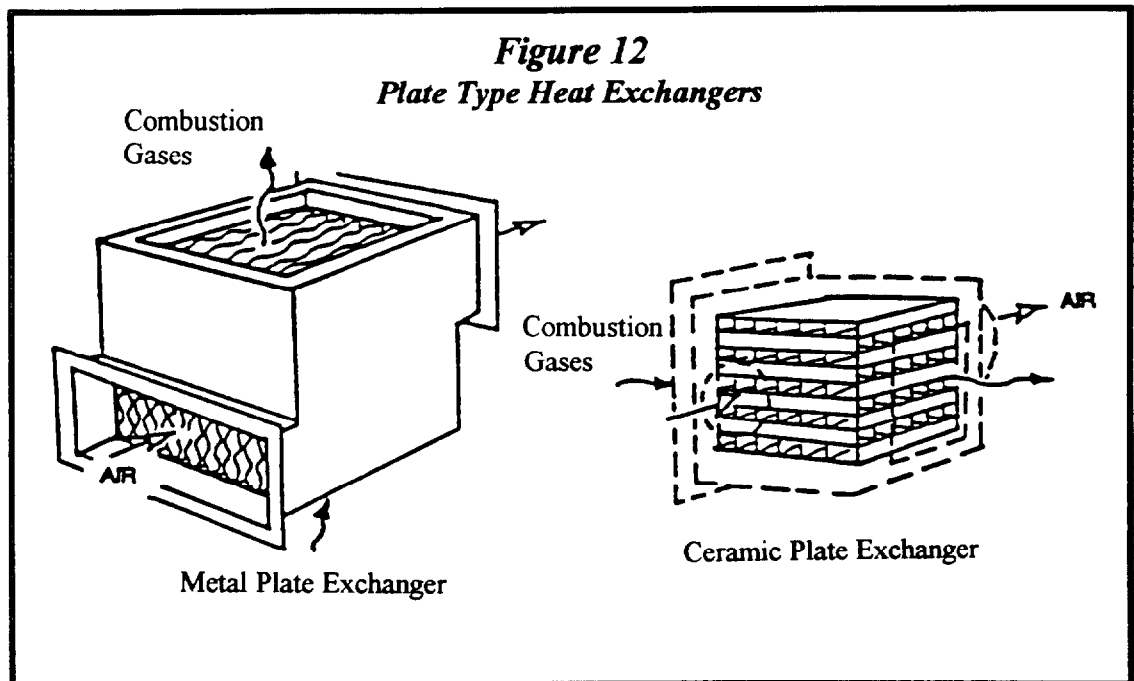

Energy Efficiency Measures Specific to the Aluminum Industry

In another type of convection heat exchanger the exchanger is an integral part of the burner with direct flaming, as in the case of a crucible furnace shown in Figure 13, or radiating type heat, as shown in Figure 14. This recovery technology may be interesting, even for smaller size furnaces.

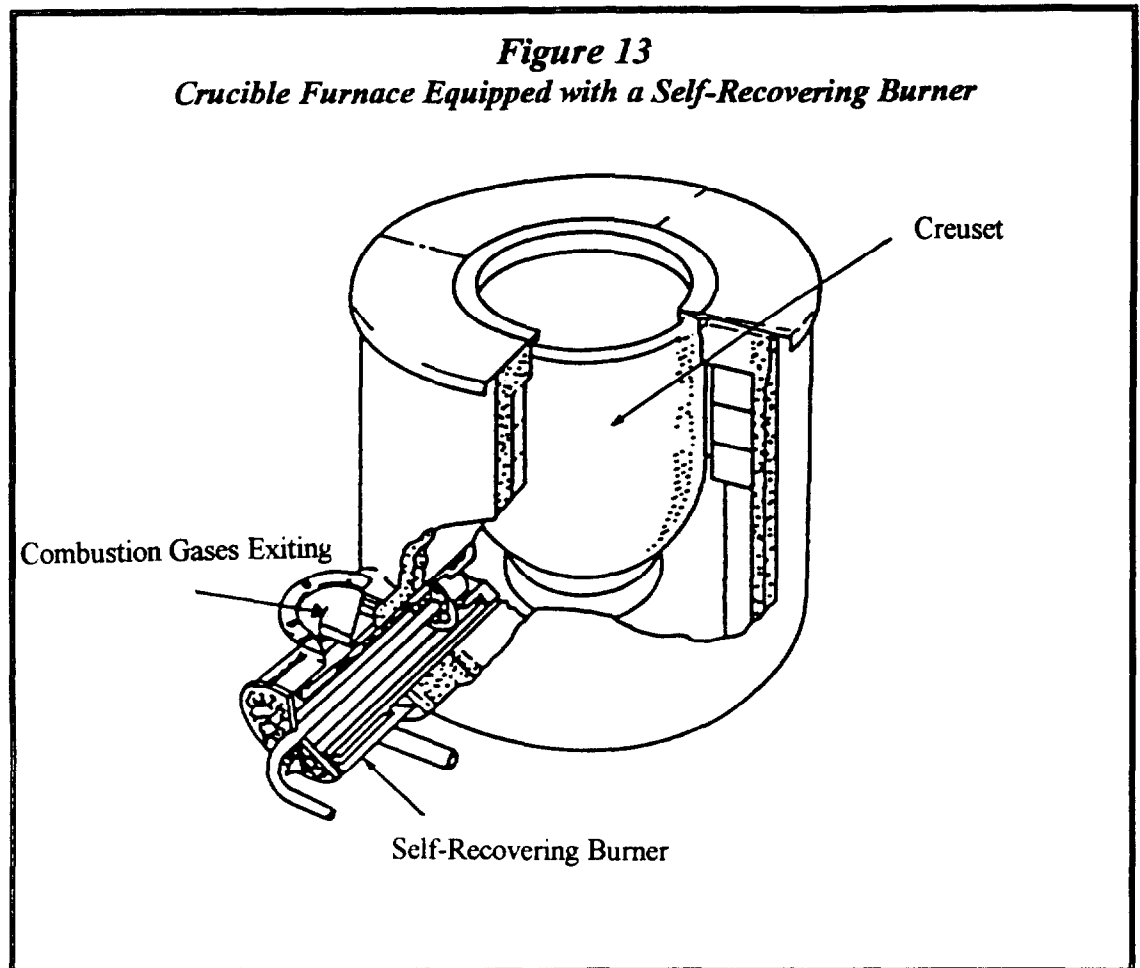
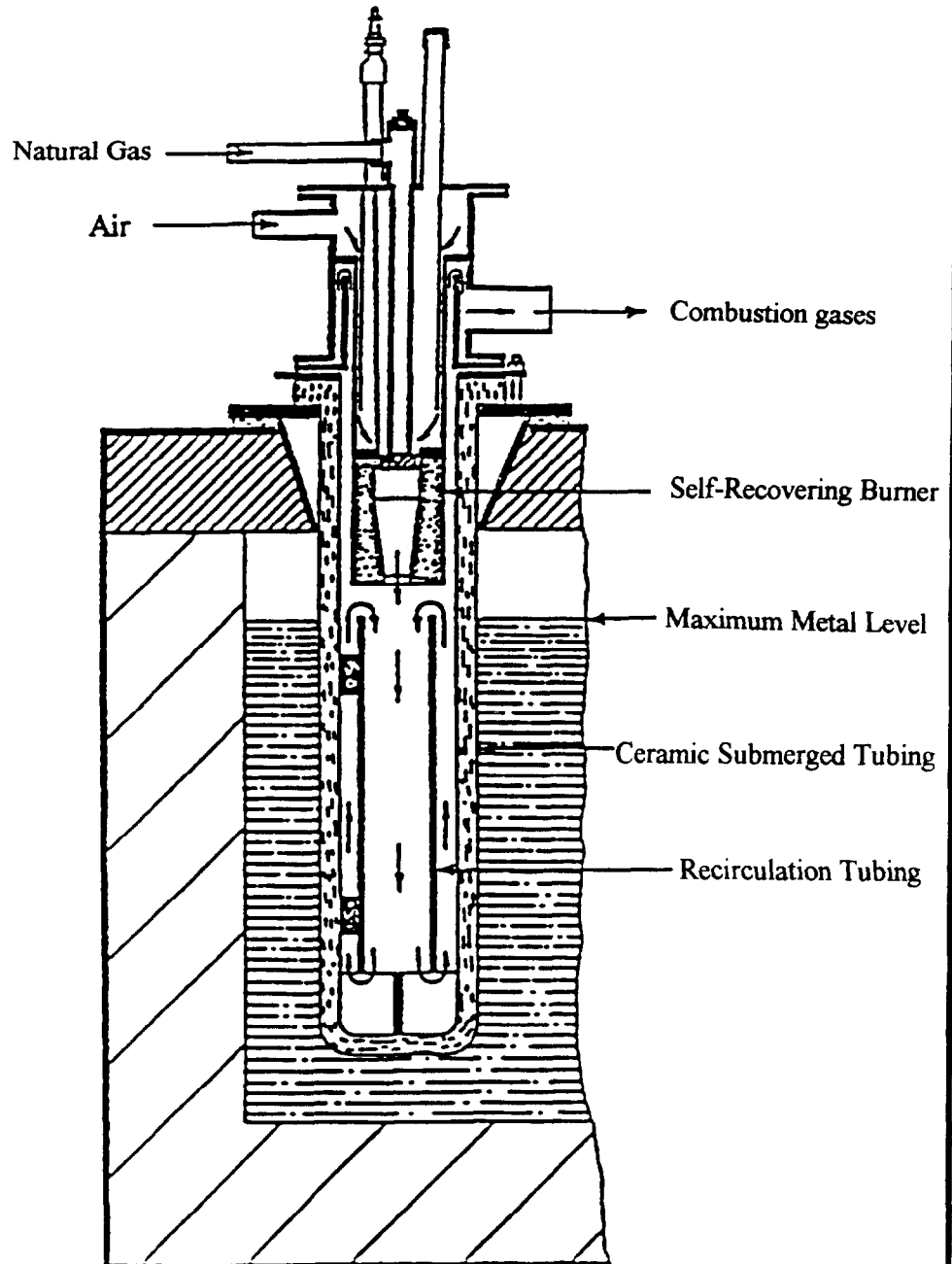

Figure 14
Submerged Natural Gas Burner



Energy Efficiency Measures Specific to the Aluminum Industry

The main drawback of convection exchangers is that they generally process combustion gases at temperatures below 1,200/1,300 °C. Their design is not recommended for some dirty or corrosive environments. It is necessary to check compatibility with the use of chlorine, frequently used in the aluminum melting process, because of potential corrosion problems.

2.4.2 Heat Regenerators

A heat regenerator is defined as a device for the storage of energy. Each regenerator contains heat storing material in which the energy contained in combustion gases may be stored as they pass through. This heat storage material consists of ceramic balls installed in tanks with refractory lining.

This type of equipment operates according to the alternating principle, using short storage loading and release cycles. During the energy loading cycle, the burner becomes the heat source for the regenerator. At the end of the energy storage period in the cycle, the flow of combustion gases is interrupted and cold air (combustion air, for instance) is introduced through the heated storage medium. The cold air then extract heat from this medium and its temperature increases. When a storage medium no longer has enough heat available, the regenerator must be “reloaded”. Airflow is then interrupted to switch to combustion gases until the next regeneration cycle, which often lasts less than 30 seconds in all.

Energy Efficiency Measures Specific to the Aluminum Industry

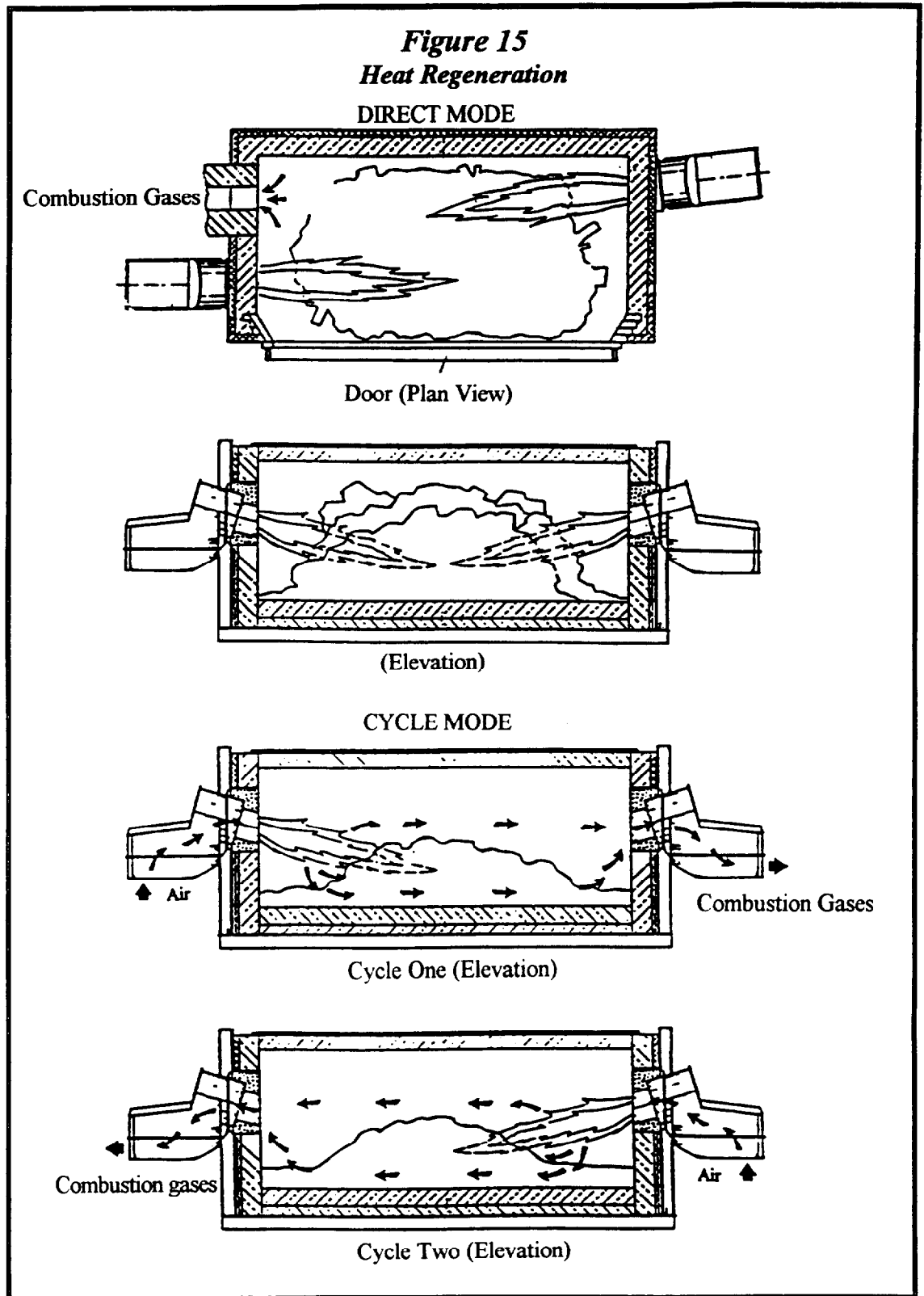
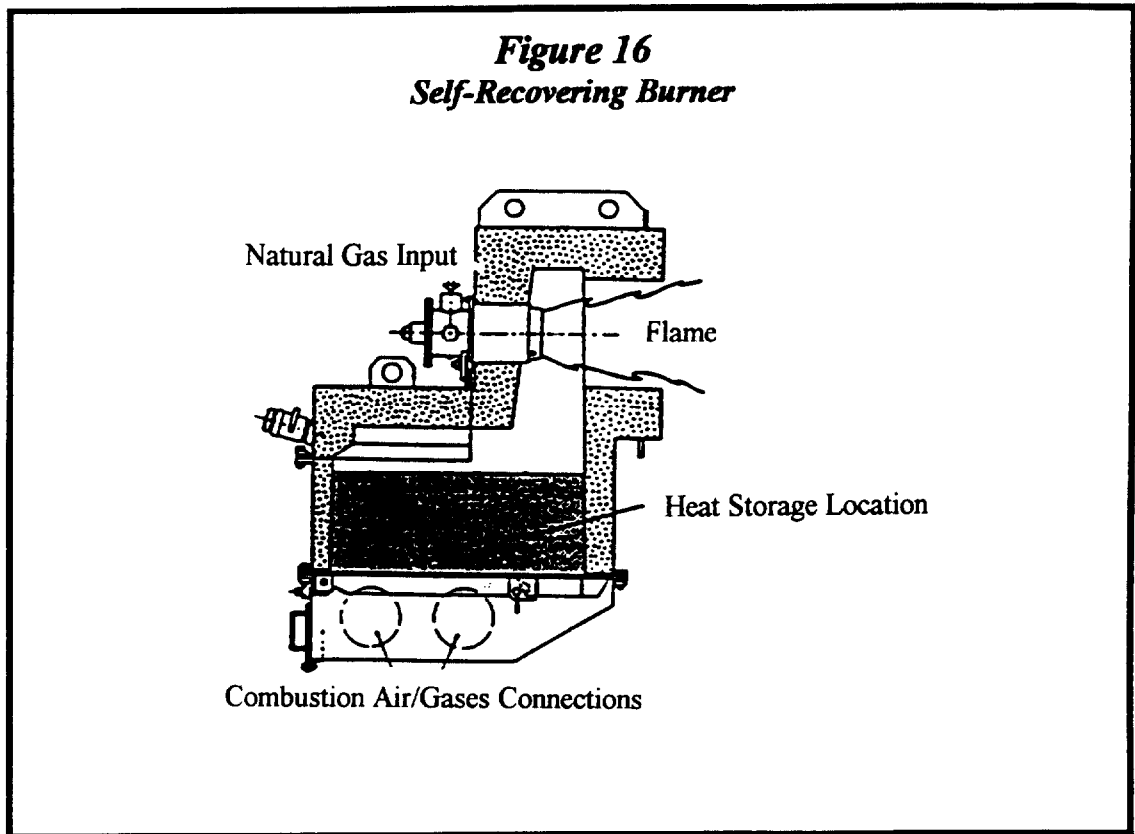
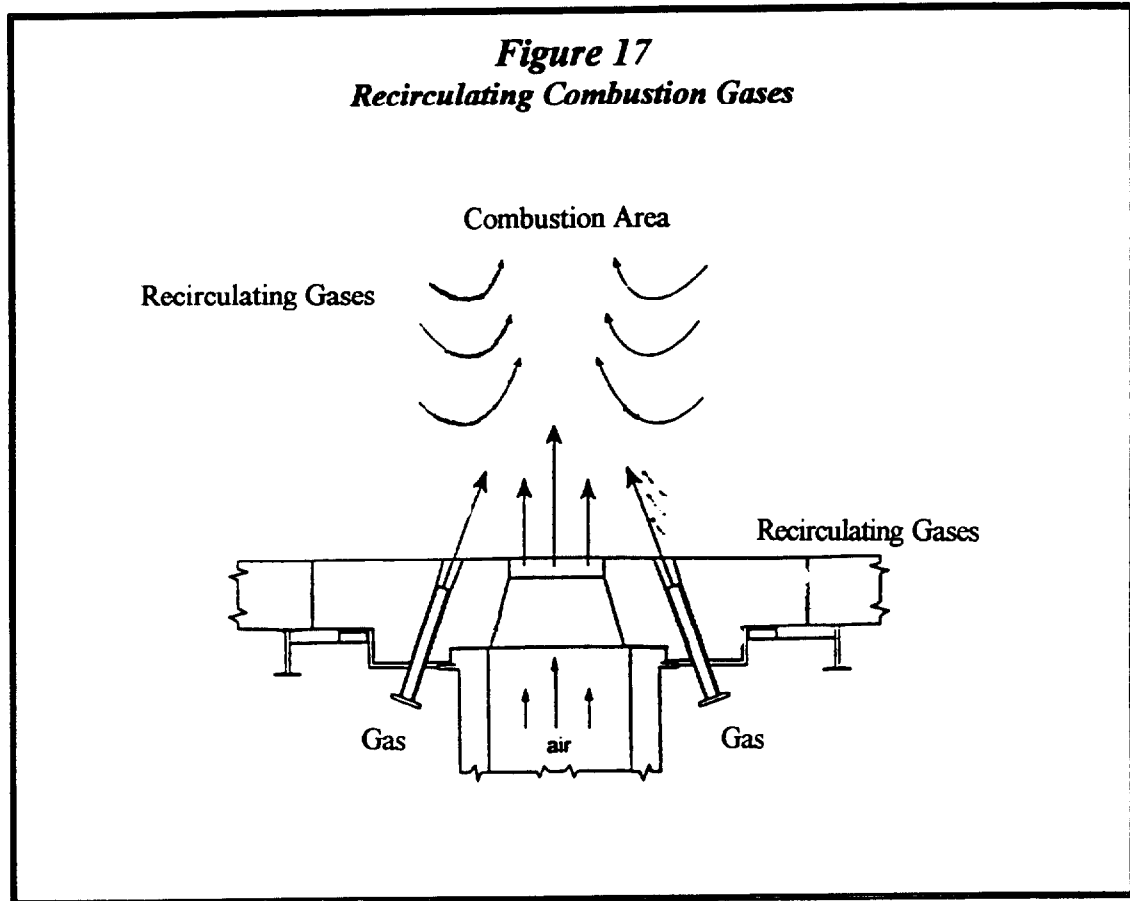

Figure 16
Self-Recovering Burner



In order to maintain continuous flow of air and combustion gases, it is necessary to cycle regenerators as pairs, one being loaded with energy by combustion gases while heat in the second is released in the air. Safety mechanisms are required in order to ensure that temperature of combustion gases does not decrease below the critical threshold represented by the dew point of some of its components. Some burner types use a recirculation of combustion gases inside the furnace hearth in order to maintain NO_x content at an acceptable level. Such recirculation is generated by the venturi effect created by the thrust of the flame and natural gas injection nozzles also aimed at the flame area.



The main benefits provided by heat regenerators include a very high efficiency ratio (75% to 95%), often at high temperature; the capability to be used with combustion gas temperatures as high as 1,370 °C; as well as their great tolerance to dirty or corrosive gases. In addition, since there is no partition nor other physical barrier between combustion gases and combustion air, all issues of seals and tightness go away. Medium cleaning is effected through regularly scheduled washes and on this type of equipment maintenance is often carried out without any production stoppage. In the event of failure or during maintenance work on the heat regeneration system, the furnace operator may choose to bypass the cycling mode and use burners in a direct firing mode.

Energy Efficiency Measures Specific to the Aluminum Industry

On the other hand, the main drawback of heat regenerators are a higher cost than conventional heat recovery devices at a comparable performance level; the requirement to operate them as a pair; as well as high maintenance costs due to the complexity of valves and controls required. Common problems to be monitored are the clogging of ceramic tanks, degradation of materials in the exhaust system and overheating of refractory lining that could occur in some furnace locations through a return of combustion gases to the burner.

3.0 OTHER MEASURES APPLICABLE TO ALUMINUM SMELTERS

This section of the guide presents a brief outline of three (3) other measures that may be implemented in the aluminum industry.

3.1 MELTING OF SECONDARY ALUMINUM USING OXY-FUEL

There are several methods and combinations thereof to create combustion enhanced through the use of oxygen in industrial furnaces such as oxygen enrichment of combustion air, the addition of oxygen injectors and installation of oxy-fuel burners. Improvements to a furnace overall productivity and fuel consumption are more directly influenced by oxygen concentration than by the difference in methods involving the use of oxygen. The main benefit of oxygen enrichment is how simple it is to convert existing burners. Such a step will often increase heat production rates in the furnace in the order of 10% to 20%.

Direct oxygen enrichment of combustion air is the simplest technique towards using oxygen with burners designed for conventional air combustion. Oxygen is often injected into the combustion air intake duct upstream from the burner. Such oxygen enrichment sharply increases flame temperature and precautions must often be taken in order to limit the temperature of the burner assembly and the surrounding refractory lining as well as to properly monitor temperature distribution within the furnace.

Another method used in reverberatory furnaces consists in adding an injector installed at an angle through the furnace wall, close to the location of a conventional burner. Such an injector is often installed below the flame area in order to increase temperature at the base of the flame and foster local heat transfer to the aluminum load below while at the same time minimizing the risk of

overheating the furnace roof. The main benefits of such an injector assembly are a low installation cost and the capability to adjust attributes of the resulting flame.

An oxy-fuel burner may be used as a supplement to conventional burners or as a replacement in order to increase a furnace efficiency. It is often positioned so as to improve temperature distribution within the furnace or, when we wish to use a very high-temperature flame, directly on the aluminum load. Most oxy-fuel burners available today produce low NO_x, involve recirculation of combustion gases and are equipped with a flame adjustment device.

A hybrid air/oxy-fuel burner may be used in oxy-fuel mode during the initial furnace preheating stage, during which the emphasis is on heating the load through convection until melting point is reached since this makes it possible to have a lower in-furnace temperature, generates little NO_x and produces low radiation from the furnace refractory lining at such temperature. Later, the oxy-fuel mode is used again at high temperature since this tends to eliminate most of nitrogen from the furnace atmosphere, thereby decreasing possible production of NO_x and also because of a greater furnace efficiency achieved through a decrease in the order of 20% in combustion gases and related impact.

3.2 INSTALLING A CIRCULATING PUMP IN MELTING FURNACES

The installation of a circulating pump to move the aluminum bath in a reverberatory furnace creates a vortex effect that speeds up the aluminum melting process, improves heat transfer and enhances the furnace overall energy performance, bath temperature uniformity as well as thermal stability. The use of a pump also makes it possible to decrease the number of times the furnace doors are opened, thereby reducing thermal losses.

However, other factors must be taken into consideration when installing such a pump, such as the cost of maintenance, spare parts, additional energy required for pump operation as well as impact on aluminum production quality.

3.3 INSTALLATION OF REAL-TIME CONTROLS FOR THE COOLING OF ALUMINUM INGOTS

The purpose of the secondary cooling system is to control the thermal state of molten aluminum when cast into molds. This technology has been successfully proven in Finland.

The controller used in the aluminum ingot cooling process is based on a real-time heat transfer model. It computes current temperature distribution in the billet according to casting speed, temperature zones and secondary and overheat water flow rates. The water flow rate for each cooling zone is then computed on the basis of the differential between target temperature and actual temperature.

Such cooling control allows for increased production through a decrease in metal losses. There is an indirect energy saving since less energy is consumed remelting aluminum scraps.

4.0 CONCLUSION

The purpose of this guide to energy efficiency in the aluminum industry was to present certain energy conservation measures that may be implemented in aluminum smelters as well as corresponding analysis and implementation methods.

The search for energy savings calls for an overall perspective on all components in the manufacturing process and equipment involved. The resulting list of options includes actions that may deal with the aluminum manufacturing process, such as combustion in a melting furnace or other measures used conventionally in the industrial sector, such as the replacement of registers with the installation of a variable-speed drive on a motor. These more conventional measures may prove most profitable and a study of them should not be neglected. Also, an impact analysis of any of these measures on the manufacturing process must be carried out with the greatest care.

The search for solutions requires a good knowledge of profitability and energy rating principles. Such measures are generally classified in increasing order of profitability and often impact on the overall plant production performance. The drafting of an energy statement at the process or plant level is an excellent tool which makes it possible to determine achievable potential savings within a plant. Finally, implementation of proper monitoring of energy consumption helps achieve the optimum performance level for equipment.

The enlightened choice among energy conservation measures constitutes a significant step towards achieving the energy consumption objectives set for the plant. Their implementation may also extend beyond the simple energy efficiency framework by making the plant competitive — or more competitive — on world markets.

BIBLIOGRAPHY

The Aluminium Association. *Aluminium Industry Energy Conservation Workshop X Papers*. October 1987.

American Gas Association. *Natural Gas Applications for Industry: Volume II: Aluminium Industry*. September 1988.

American Society of Heating, Refrigerating and Air-Conditioning Engineers. *ASHRAE Handbook Fundamentals*. 1997.

British Gas School of Fuel Management. *Combustion Engineering and Gas Utilisation, 3rd Edition*. 1992.

CADDET Analyses Series No. 1. *Learning from experiences with Process Heating in the Metals Industry*. 1993.

Eclipse Combustion Division. *Recuperation and Regeneration Systems*. Undated.

European Aluminium Association. *Ecological Profile Report for the European Aluminium Industry* February 1996.

European Aluminium Association. *Environmental Issues in the Aluminium Industry*. February 1996.

Gaz Métropolitain, Informattech Volume 4, No. 3. *La recherche des économies d'énergie pour les fours industriels*. July 1989.

Hydro-Québec. *Les moteurs à haut rendement*. 1992

Hydro-Québec, Programme d'initiatives et d'analyses énergétiques. *Systèmes de pompage, de ventilation et de compression (SPVC)*. 1994

North American Mfg. Co. *Combustion Handbook Volumes I and II, 3rd Edition*. March 1997.

U.S. Department of Energy in cooperation with The Aluminium Association, Office of Industrial Technologies. *Report of the Aluminium Technology Roadmap Workshop*. February 1997.

U.S. Department of Energy. *Energy and Environmental Profile of the U.S. Aluminium Industry*. Undated.

**AUTHORS AND MAIN ORGANIZATIONS
MENTIONED IN THIS GUIDE**

MAIN COLLABORATORS ON THIS PROJECT:

Aluminum Association of Canada

Mr. Christian L. Van Houtte
1010, Sherbrooke Street West
Suite 1600
Montreal, Quebec Canada
H3A 2R7
Phone (514) 288-4842
Fax (514) 288-0944

**Natural Resources Canada
Office of Energy Efficiency**

Mr. Vaughn G. Munroe, P. Eng.
Industry Officer
Industrial, Commercial and Institutional
Programs Division
580 Booth Street, 18th Floor
Ottawa, Ontario Canada K1A 0E4
Phone (613) 947-1594
Fax (613) 947-4121

Soprin ADS

Mr. Pierre Langlois, P. Eng.
1220, boul. Lebourgneuf
Suite 1200
Quebec, Quebec
Canada G2K 2G4
Phone (418) 626-1688
Fax (418) 626-5464