

Energy Management Information Systems

ACHIEVING IMPROVED ENERGY EFFICIENCY

A handbook for managers, engineers and operational staff



Published by the Office of Energy Efficiency of Natural Resources Canada

Co-authored by James H. Hooke
Byron J. Landry, P.Eng.
David Hart, M.A., C.Eng.

Funded by Natural Resources Canada, Union Gas Limited, Enbridge Gas Distribution



CEATI – End-Use Technologies Interest Group
(BC Hydro, Manitoba Hydro, Hydro-Québec, Pulp and Paper Research Institute of Canada,
New York State Electric & Gas Corporation)

2003



BC hydro
POWER SMART

Manitoba
Hydro
POWER SMART

Hydro
Québec



NYSEG

Disclaimer

The views and ideas expressed in this handbook are those of the authors and do not necessarily reflect the views and policies of the funding organizations. The generic opportunities presented herein do not represent recommendations for implementing them at a specific site. Before modifying any equipment or operating procedures, consult qualified professionals and conduct a detailed site evaluation.

Library and Archives Canada Cataloguing in Publication

Main entry under title:

Energy management information systems: achieving improved energy efficiency:
a handbook for managers, engineers and operational staff

Aussi disponible en français sous le titre : Systèmes d'information sur la gestion de l'énergie.

ISBN 0-662-38024-X

Cat. no. M144-54/2004E

1. Information storage and retrieval systems – Power resources.
 2. Energy conservation – Handbooks, manuals, etc.
 3. Energy auditing – Handbooks, manuals, etc.
- I. Canada. Office of Energy Efficiency.

TJ163.3E53 2004

025.06'33379

C2004-980297-6

© Her Majesty the Queen in Right of Canada, 2004



Recycled paper

Contents

1	Preface	1
2	What Is an Energy Management Information System?	5
	Overview	5
2.1	What Is an EMIS?	7
2.2	Energy Management Programs and the EMIS	7
2.3	What Does an EMIS Deliver?	9
2.3.1	Early Detection of Poor Performance	9
2.3.2	Support for Decision Making	13
2.3.3	Effective Performance Reporting	15
2.3.4	Auditing of Historical Operations	17
2.3.5	Identification and Justification of Energy Projects	18
2.3.6	Evidence of Success	19
2.3.7	Support for Energy Budgeting and Management Accounting	19
2.3.8	Energy Data to Other Systems	20
2.4	What Are the Elements of an EMIS?	20
2.5	Solutions for Different Circumstances	21
3	What Makes an EMIS Successful?	23
	Overview	23
3.1	Elements of Success	24
3.1.1	Management's Understanding and Commitment	24
3.1.2	Company Policies, Directives and Organization	24
3.1.3	Program Responsibilities	25
3.1.4	Procedures and Systems	25
3.1.5	Project Selection and Focus	25
3.1.6	Approved Budget	26
3.1.7	Approved Investment Criteria	26
3.1.8	Training	26
3.1.9	Integrated Information Systems	26
3.1.10	Reports on Savings Achieved	26
3.1.11	Motivation	27
3.1.12	Marketing	27

3.2	Evaluation	27
4.	Real-Time Data Is Required	29
5.	How Can Action Ensure Improvements?	31
	Overview	31
5.1	Who Should Take Action?	31
5.2	What Is Needed to Take Action?	32
	5.2.1 Energy Data	32
	5.2.2 Targets	32
	5.2.3 Reports	33
	5.2.4 Training	33
	5.2.5 Decision Support	34
	5.2.6 Audited Success	34
	5.2.7 Motivation and Recognition	34
	5.2.8 Benchmarking and Best Practices	34
6	How Is an Effective EMIS Designed and Justified?	37
	Overview	37
6.1	Creating a Vision of an Effective EMIS	37
	6.1.1 Address Site Needs	37
	6.1.2 Usefulness of the System	37
6.2	Beginning Design: Consider Measurement Issues	38
6.3	The Next Step: Consider Integration Into Existing Systems	39
6.4	Prepare a Supporting Case: Cost/Benefit	40
6.5	Obtaining Support From Decision-Makers	41
6.6	Designing and Implementing an EMIS: A Checklist	42
7	Effective Energy Reporting	45
	Overview	45
7.1	What Is an Effective Report?	47
7.2	Who Requires Energy Reports?	48
	7.2.1 Executives	48
	7.2.2 Operations Management	49
	7.2.3 Operations Personnel	49
	7.2.4 Engineering	51
	7.2.5 Accounts	51
	7.2.6 Energy and Environmental Managers	51
	7.2.7 External Advisors	52
7.3	A Staged Approach	52



8	Energy Data Analysis	53
	Overview	53
8.1	What Is Energy Data?	55
8.2	Objectives of Energy Data Analysis	56
8.3	Breakdown of Energy Use and Costs	56
8.4	Calculation of Performance Indicators	59
8.5	Understanding Performance Variability: Simpler Techniques	59
8.6	Understanding Performance Variability: Data Mining	62
8.7	Calculating Targets	68
8.8	Data Modelling and “What If” Analysis	71
9	Metering and Measurement	73
	Overview	73
9.1	Introduction	74
9.2	The Need for Metering	74
9.3	Deciding Where to Locate Meters and Sensors	75
9.3.1	Step 1: Review Existing Site Plans	76
9.3.2	Step 2: Develop a Meter List	76
9.3.3	Step 3: Assign Energy Accountability Centres	76
9.3.4	Step 4: Decide on Additional Metering or Measurement	77
9.4	Deciding on What Types of Metering to Use and Practical Considerations	78
9.4.1	Electrical Metering	78
9.4.2	Natural Gas Metering	79
9.4.3	Steam Metering	80
9.4.4	Water and Condensate Metering	82
9.4.5	Compressed-Air Metering	82
9.4.6	Data Loggers	83
9.5	Linking Meters to Monitoring Systems	83
9.6	Cost Considerations	84
9.7	Concluding Remarks	85
10	Do You Have an Effective EMIS? A Checklist	87
	Appendix A: Abbreviations	91
	Appendix B: Figures and Tables	92



Preface

The Kyoto Protocol requires Canada to reduce its greenhouse gas emissions by 6 percent below 1990 levels by 2008–2012. This, in addition to rising energy costs and deregulation in the electricity and gas industry, has once again provided new impetus for companies to improve their energy use efficiency in order to reduce operating costs, increase profits and reduce greenhouse gas emissions that contribute to climate change.

This handbook, written for all levels of management and operational staff, aims to give a structured and practical understanding of an Energy Management Information System (EMIS) and to serve as an instruction guide for its implementation. Because it covers all aspects of an EMIS – including metering, data collection, data analysis, reporting and cost/benefit analyses – this handbook is an integral part of a company's Energy Management Program (EMP). The authors present state-of-the-art techniques coupled with their own experience and technical input from this handbook's sponsoring organizations: Natural Resources Canada, Union Gas Limited, Enbridge Gas Distribution and CEATI – End-Use Technologies Interest Group (BC Hydro, Manitoba Hydro, Hydro-Québec, the Pulp and Paper Research Institute of Canada and New York State Electric & Gas Corporation).

There are vast opportunities to improve energy use efficiency by eliminating waste through process optimization. Applying today's computing and control equipment and techniques is one of the most cost-effective and significant opportunities for larger energy users to reduce their energy costs and improve profits.

In his widely acclaimed book *Megatrends* (1982), John Naisbitt states, "Computer technology is to the information age what mechanization was to the industrial revolution." This insight has proven to be extremely accurate. Modern computing and control techniques, particularly in larger companies, are among the most cost-effective and significant tools with which industrial and commercial facilities can improve energy use efficiency.

"Computer technology is to the information age what mechanization was to the industrial revolution."

– JOHN NAISBITT

Today it is normal for companies, particularly in process sectors, to collect huge amounts of real-time data from automated control systems, including Programmable Logic Controllers (PLCs), Supervisory Control and Data Acquisition (SCADA), etc. In addition, a host of other computerized systems and associated databases are maintained at the corporate and/or managerial level. Integrated computer systems are commonly used to enhance performance in most facets of business, including

finance and accounts, personnel, stock control, sales and marketing, production and scheduling, resource planning, asset management, maintenance planning, process control and monitoring, design, training and other areas.

However, unless this captured data is shared and analysed in an orderly and precise way that identifies problem areas and provides solutions, this mass of data is merely information overload.

Unanalysed data is information overload.

Data is not knowledge! Knowledge is information learned from patterns in data, and it follows that there must be the capacity and ability to convert information into knowledge in order to make sound energy-related business decisions. This is key in any management function. In many businesses it is often difficult to comprehensively analyse total energy use. Patterns of energy use are very complex, particularly in process industries where it is difficult to understand what causes energy use to rise and fall, especially when production rates are highly variable, when the product mix varies, or when there are several interacting processes at a single site. It is vital, however, for managers to be able to decipher this information in order to make good energy and business decisions.

Advances in information technology (IT), defined here as the use of computers to collect, analyse, control and distribute data, have developed rapidly. It is now common for managers and operators to have access to powerful computers and software. Today there are a number of techniques to analyse the factors that affect efficiency, and models are automatically generated based on “what if” scenarios in order to improve decisions to be taken.

In the 1980s, the Canadian Industry Program for Energy Conservation (CIPEC) developed two versions of an energy accounting manual (basic and advanced) to help Canadian organizations in the industrial, commercial and institutional sectors design and implement energy-accounting systems that were capable of monitoring energy productivity and performance. A 1989 revision of these manuals, still available from the Office of Energy Efficiency of Natural Resources Canada, discusses the fundamentals of energy accounting and provides a standard format that can be applied to single- and multi-unit organizations. The manual has been referred to as a first-generation energy management tool for businesses and other organizations.

In the 1990s, the UK Office of Energy Efficiency developed the first recognized energy management system, called Monitoring and Targeting (M&T). Based on the same fundamentals as CIPEC’s energy accounting manual, it took full advantage of the increased use of computers and was the first automated energy management system. In the field of energy management, it was known as the second-generation energy management tool.

Both approaches, however, tend to focus exclusively on energy, with varying degrees of success. Most of the initiatives relate to low- or no-cost projects and seldom look beyond HVAC systems (set-points), compressors (air leaks) and similar actions for



potential savings. Many businesses are unaware of opportunities for increasing energy use efficiency because there has been no in-depth analysis of credible and shared data that will identify profitable energy use efficiency improvements. As a general yardstick, most companies must sell \$10 worth of product to realize a profit of \$1. Conversely, every \$1,000 saved by eliminating waste and improving energy use efficiency is the equivalent of an additional \$10,000 in sales.

Recognizing the proliferation of computerized systems and the potential that databases offer, the consortium members (see inside cover) supported the development of this handbook. Its goal is to identify what a company needs in order to develop an EMIS and what it should do to get there.

This handbook is structured to allow each level of staff within an organization to refer to sections that are specifically pertinent to them, but the authors recommend that all levels of management read the entire handbook.

The authors have been part of the groups that developed and implemented the EMIS examples described in this handbook, and their practical application of proven information reflects the authors' underlying theme that energy is a variable operating cost, not a fixed overhead charge.

*Energy is a variable
operating cost, not a fixed
overhead charge.*



What Is an Energy Management Information System?

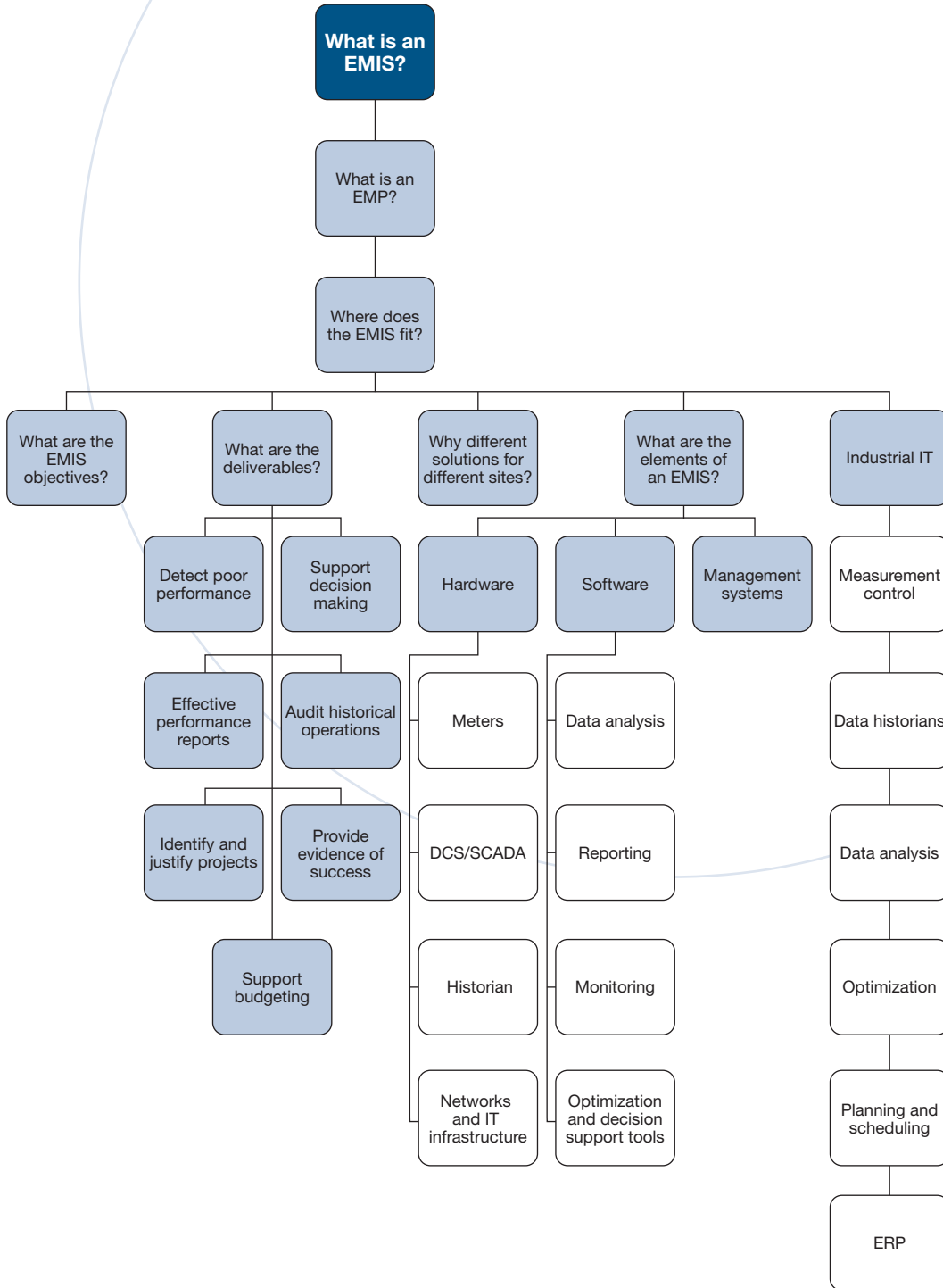
Overview

An Energy Management Information System (EMIS) is an important element of a comprehensive energy management program. It provides relevant information to key individuals and departments that enables them to improve energy performance.

An EMIS can be characterized by its deliverables, features, elements and support. Deliverables include the early detection of poor performance, support for decision making and effective energy reporting. Features of an EMIS include the storage of data in a usable format, the calculation of effective targets for energy use, and comparison of actual consumption with these targets. Elements include sensors, energy meters, hardware and software (these may already exist as process and business performance monitoring systems). Essential support includes management commitment, the allocation of responsibility, procedures, training, resources and regular audits.

This section outlines what constitutes an effective EMIS. The checklist in Section 10 will help determine whether a proposed or existing EMIS will succeed. Questions addressed in this section are summarized in Figure 1.

Figure 1. Basics of an EMIS



2.1 What Is an EMIS?

An EMIS provides information to appropriate personnel within an organization to help them manage energy use and costs. The exact nature of the EMIS will depend on

- the particular site
- the processes and plant involved
- the cost of energy (in relation to other costs)
- existing meters and instruments
- monitoring and control systems
- the data historian
- data analysis and reporting systems
- existing management systems

In this handbook, an EMIS is defined principally in terms of what it delivers to the organization; how the deliverables are achieved is secondary.

Over the years, EMISs have been implemented with varying levels of success and sustainability. The checklist in Section 10 outlines what constitutes an effective EMIS, i.e., one that will reduce energy costs by at least 5 percent and sustain that improved performance. Readers should ensure that their proposed or existing EMIS meets these requirements (examine each of the items in the checklist).

This handbook discusses the components in the checklist in some detail, and we strongly suggest that readers revisit the checklist once they have studied this handbook.

2.2 Energy Management Programs and the EMIS

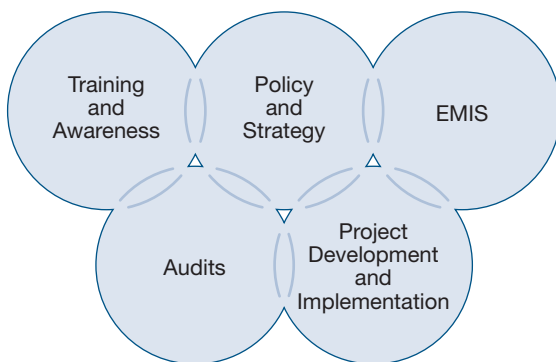
An Energy Management Information System (EMIS) is only one element of a comprehensive energy management program (EMP), albeit an important one without which full benefits will not be achieved and sustained. A good EMIS should reduce energy use (and cost) by at least 5 percent.

Actions that generally need to be taken in order to address energy use in an EMP may include one or more of the following:

- developing and approving an energy policy and strategy
- training and actions to raise knowledge and awareness
- energy audits to identify and evaluate opportunities
- developing and implementing improvement opportunities
- implementing performance management systems, including the EMIS



Figure 2. Elements of an energy management program (EMP)



*How does the EMIS
fit with an Energy
Management Initiative?*

An organization's energy policy should have agreed-upon objectives and demonstrate senior management's commitment. The policy's energy strategy should outline specific plans to achieve improved performance.

Training is essential to ensure that operations personnel understand key energy issues and what actions they need to perform in order to reduce costs. Activities to raise awareness can also be used to emphasize the need to reduce energy use and make the link between energy and the environment.

Energy audits are traditionally the foundation of an organization's energy conservation plan. Audits are usually carried out by experienced engineers and identify and quantify where energy is used and find measures for improvement. These measures may be low- or no-cost changes or require capital investments.

Once opportunities are identified, they need to be developed into projects that can be justified and implemented. Developing the project includes accurate estimates of costs and benefits and assessments of practical, safety and environmental issues.

Performance management systems aim to ensure that benefits are achieved and sustained through monitoring, performance analysis and effective reporting to all levels of an organization.

An EMIS is the key element of performance management; it also provides essential support to the energy auditing process. A modern EMIS will be a software solution that is tightly integrated into an organization's systems for process monitoring and control and IT systems. Furthermore, the EMIS will often be part of a larger system used to manage process (and business) performance more generally.

It is important to recognize that an EMIS does not stand alone. It needs management commitment, procedures, organization, training and appropriate technical expertise.



2.3 What Does an EMIS Deliver?

The principal objective of an EMIS is to support an organization's energy management program. Its specific deliverables are as follows:

- 2.3.1 Early detection of poor performance
- 2.3.2 Support for decision making
- 2.3.3 Effective performance reporting
- 2.3.4 Auditing of historical operations
- 2.3.5 Identification and justification of energy projects
- 2.3.6 Evidence of success
- 2.3.7 Support for energy budgeting and management accounting
- 2.3.8 Energy data to other systems

Understanding what an EMIS can deliver is vital if an effective system is to be designed and implemented. Based on the following discussion, readers should be able to specify the requirements of an EMIS for their particular site.

Specify what the EMIS will deliver.

2.3.1 Early Detection of Poor Performance

A key deliverable of an EMIS is that it will identify poor operations quickly and effectively. Examples are:

- incorrect control set-points
- equipment left operating unnecessarily
- faults with equipment, for example, heat exchanger fouling, air in refrigeration condensers, etc.

Such faults should be identified as quickly as possible and corrected with practical and cost-effective solutions. It is not sufficient to detect a problem that has occurred in the past (for example, last week) that cannot now be rectified because too much time has elapsed and operations have moved on to a new "mode."

Comparing actual performance with targets generally identifies poor performance. A deviation from the target causes an alert. Performance indicators include energy consumption, but can also include measures of efficiency and indirect indicators of performance (for example, the oxygen level in a boiler's exhaust).

Targets can be defined in a number of ways, all of which can be usefully applied. Examples are:

- the performance typically achieved by the process in the past – current and future performance can be measured against this to demonstrate progress (**benchmark**)
- the best performance that the process could achieve or has achieved in the past (**best practice**)
- a desired level of performance, for example, 5 percent below the benchmark (**reduction**)
- budget performance (**budget**)

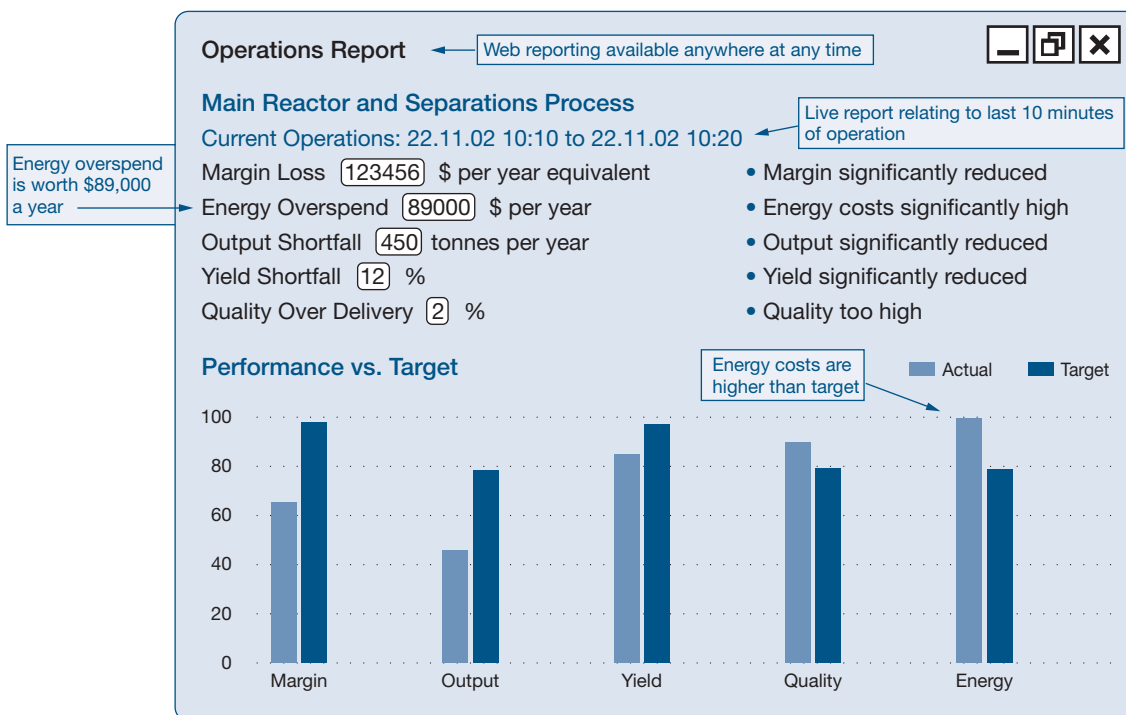
Comparing actual performance with targets identifies poor performance.



Key to success is that targets are sound, taking full account of relevant influencing factors. This is discussed in detail in Section 8.

The frequency of performance monitoring will vary depending on the application. In a complex process that uses a lot of energy, reporting every 15 minutes may be appropriate, especially where the operator can make process changes in response to performance alerts. On the other hand, an EMIS associated with a central refrigeration unit, for example, may report only daily or weekly because faults are likely to be slow to develop and be rectified only through maintenance actions (for example, condenser cleaning, refrigerant charging, etc.).

Figure 3. Operations report showing poor performance



Figures 3 and 4 show examples of reports that identify performance. Shown in Figure 3 is an alert that the last 10 minutes of performance is poor. Shown in Figure 4 is a shift performance summary showing performance that is improving.



Figure 4. Operations report showing improving performance

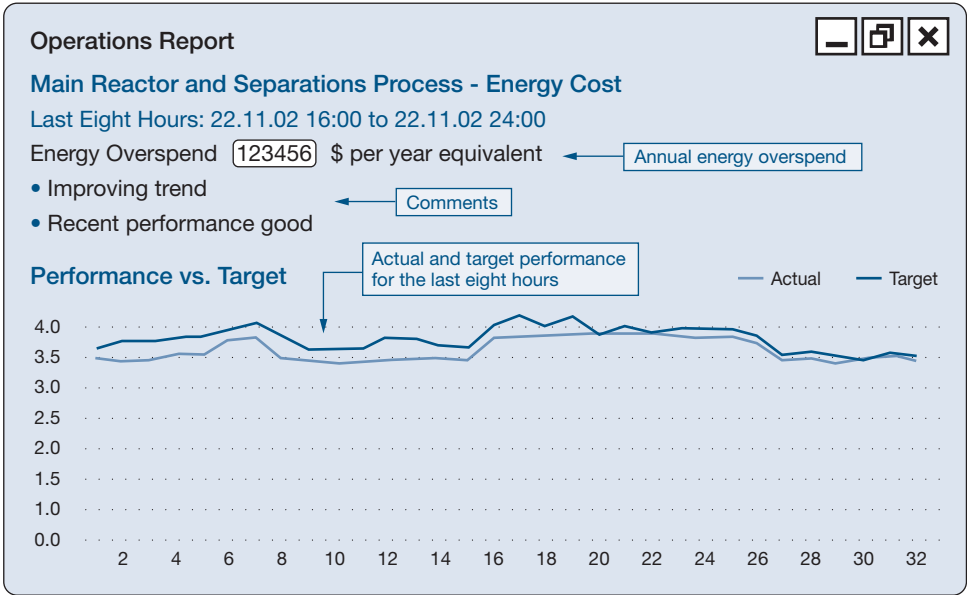


Table 1 lists examples of typical problems and their respective monitoring frequencies that a performance monitoring system can identify.



Table 1. Examples of typical problems that cause higher energy costs

Typical Problems	Monitoring Frequency*
<i>Process Operations</i>	
• incorrect set-points	hourly
• fouled heat exchangers	daily
• advanced controls switched off	hourly
• poor control timing	hourly
<i>Boilers</i>	
• poor air-fuel ratio	hourly
• fouled exchangers	daily
• excessive blow-down	hourly
• incorrect boiler selection	hourly
<i>Refrigeration</i>	
• fouled condenser	daily
• air in condenser	daily
• incorrect superheat settings	daily
• high head pressure settings	daily
• incorrect compressor selection	hourly
<i>Compressed Air</i>	
• leaks	daily
• poor compressor control	daily/hourly
• incorrect pressure	hourly
<i>Steam</i>	
• leaks	hourly
• failed traps	hourly
• poor isolation	hourly
• incorrect set-points	hourly
• low condensate return	hourly
<i>Space Heating/Cooling</i>	
• excessive space temperature	hourly
• excessive fan power use	hourly
• overcooling	hourly
• heating and cooling	hourly
• high chilled water temperature	hourly
<i>Power Generation</i>	
• poor engine performance	hourly
• incorrect control settings	hourly
• poor cooling tower operation	hourly
• fouled heat exchangers	hourly

* Appropriate monitoring frequency depends on the application.



2.3.2 Support for Decision Making

Often, alerting operational personnel and management to poor performance is enough to solve a problem. Such personnel may be experienced enough to understand the reasons for higher energy use and take appropriate remedial action. On the other hand, they may not have the needed experience or sufficient time to conduct an analysis.

Where there is a difficulty in deciding how to act on a problem, decision support systems should be considered as part of an EMIS. Such systems provide supporting information and can take several forms, from guides and charts to sophisticated computer systems.

The “knowledge” within these decision systems can be either

- from experts (**expert systems**, or **knowledge-based systems**); or
- learned from operating data (**data mining**).

The more complex and energy intensive the process, the more likely a decision support system can be justified.



Example 1. Brewery Refrigeration Expert System

A large brewery implemented an expert system to provide decision support to utility plant engineers to help them respond to sub-optimal refrigeration performance. The result was a 29.5 percent reduction in electricity consumption by the refrigeration system. The payback period for the system was well under one year.

The refrigeration plant provided chilled secondary refrigerant at approximately -3.5°C to the brewery to cool process streams, vessels and cold rooms. The energy use efficiency of the refrigeration systems was significantly affected by

- the secondary refrigerant temperature
- evaporator operation, especially fouling and the level of refrigerant
- refrigerant leaks
- expansion valve settings
- condenser performance, especially fouling and the buildup of air and non-condensable gases
- head pressure set-points
- cooling tower performance

Problems had been occurring from time to time, but they had not been specifically identified. Monitoring energy use against targets and using the expert system rectified this. Diagnosing the cause of high energy use is a relatively complex task; the key performance indicators will vary with cooling demand, secondary refrigerant temperature, ambient temperature and humidity. Analysing the situation involves

- modelling refrigeration system operation to determine expected operating conditions
- comparing actual values with the model expectations
- interpreting deviations (for example, the presence of air or non-condensable gases is indicated if the condensing pressure is high or if the liquid sub-cooling is high)

Although engineers can work through this analytical process, few have sufficient time to do so. The expert system automated the task and rapidly diagnosed the problem.

Today, developing and implementing expert systems is relatively easy. Establishing “rules” for such systems should not be difficult or complex; it is necessary only to apply simple rules consistently, accurately and quickly.

Recently, decision support systems have been implemented where “rules” are learned from historical operating data. In these cases, the system tells the operator how to modify process operations in order to achieve the best performance levels observed in the past (see Figure 3). This ensures that operations employ consistent best practices.



Figure 5. Report with instructions on how to achieve optimum operating conditions

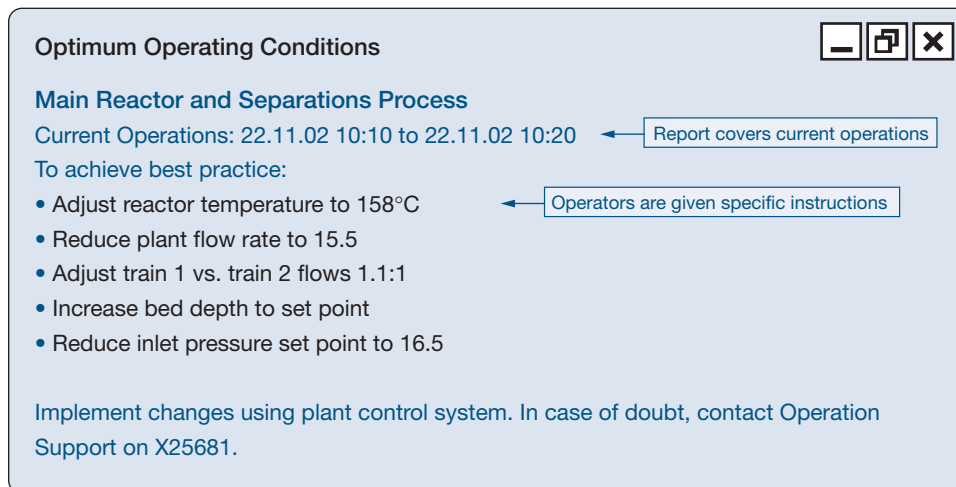
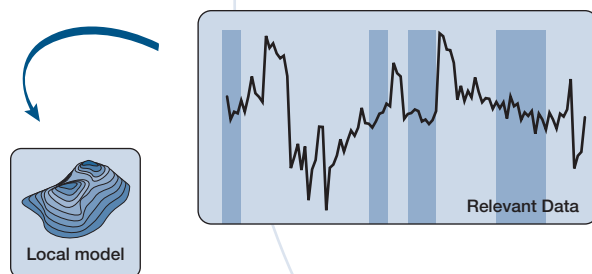


Figure 6 illustrates the concept of learning from data. Operating periods in the past that were similar to current operations (i.e., similar external disturbances such as production levels, quality, ambient conditions, etc.) are found. The best performing periods are then identified and used to determine the best set of operating conditions. In some circumstances, a simple paper-based system (based on experience or theory) can be useful.

Figure 6. Learning from data



In general, capturing knowledge about operations performance is worth serious consideration. This knowledge should be made readily available within the organization (for example, via corporate intranets).

2.3.3 Effective Performance Reporting

In addition to reporting problems to operations staff, the EMIS should also provide reports to management, executives, engineers and other key personnel (see Section 7). This is to ensure that the appropriate resource(s), commitment and expertise are applied to energy use efficiency. It is a key part of the management process to ensure that those responsible for performance are taking effective action.



Figure 7. Example of management report, showing weekly progress

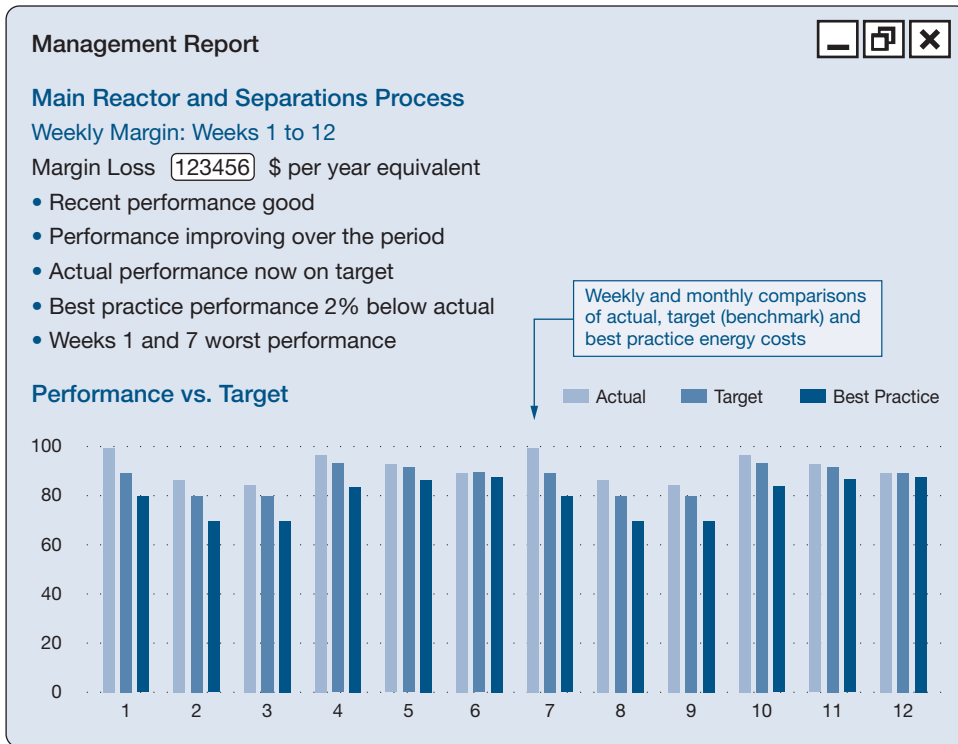
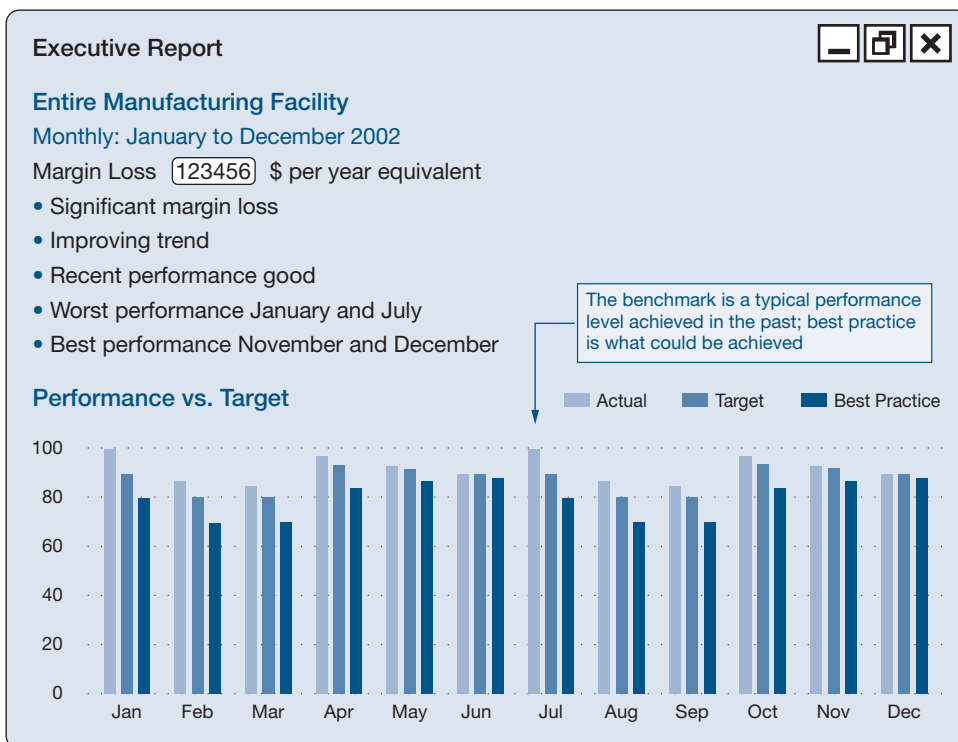


Figure 8. Example of executive report, showing monthly progress



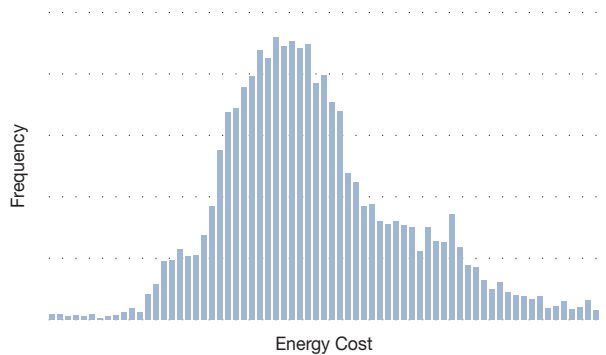
2.3.4 Auditing of Historical Operations

As well as providing ongoing information about the current energy performance of processes and equipment, an EMIS can be used to analyse historical performance. To do this, the EMIS needs a database of historical energy information and influencing factors. With modern data analysis techniques (see Section 8) this data can provide

- an audit of historical operations (**what has happened**)
- an explanation or variations in energy performance (**why energy use varied**)
- an audit of energy use and costs (**what operations cost**)

From this analysis, engineers and managers can improve their understanding of energy use efficiency, leading to better decisions.

Figure 9. Example of frequency distribution

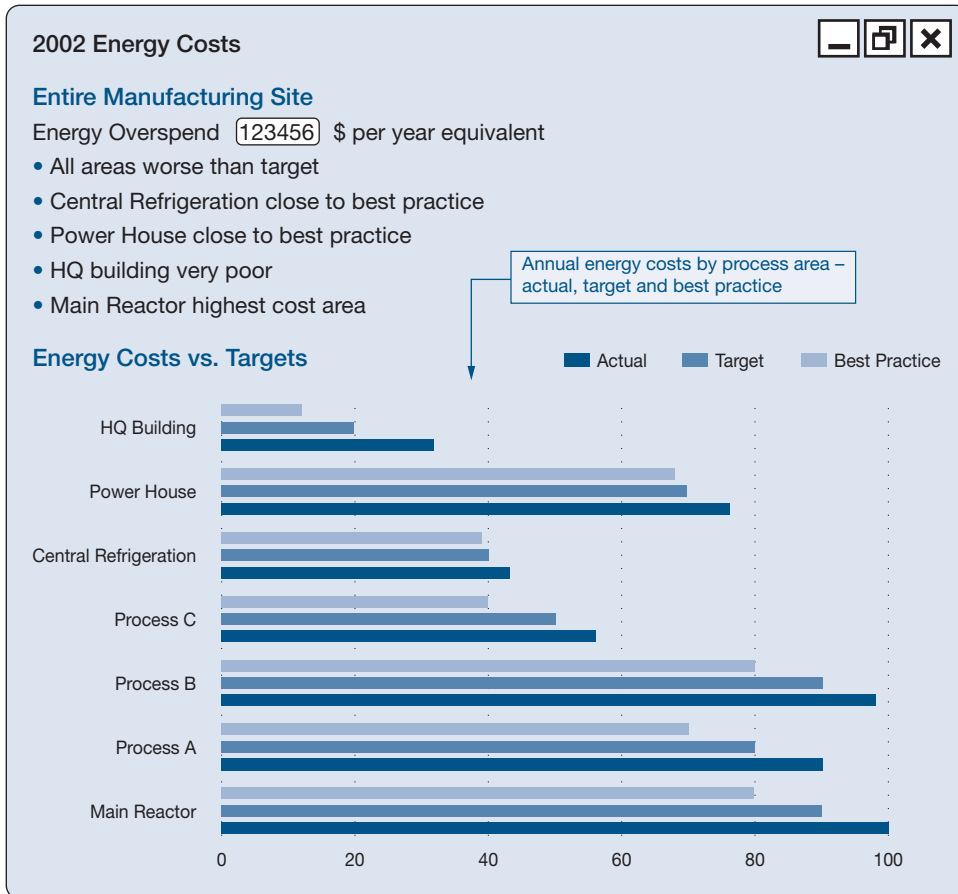


The EMIS facilitates the understanding of energy performance variations. In Figure 9, the frequency distribution shows that energy costs vary considerably about the mean. Is this due to external factors or to decisions made by plant operations and management personnel?

The “what has happened” factor is especially important in order to challenge under-performing areas (see Figure 10).



Figure 10. The EMIS should quantify energy use and costs



2.3.5 Identification and Justification of Energy Projects

An EMIS can be the foundation for identifying and justifying energy use efficiency projects. Improvements to operations and control settings can be identified using historical operating data with advanced analysis techniques (see Section 8). These improvements tend to be low- or no-cost “quick hits” and are especially attractive because they can quickly justify investment in an EMIS. Often it makes economic sense to conduct this analysis as a first step.

Analysing historical data can also reveal opportunities that require investment. Importantly, the data available from a correctly configured EMIS can

- challenge barriers to energy projects, including disagreement about how the plant is operated (e.g., is it operated close to a process or marketing constraint?)
- quantify improvements and allow energy investment to be justified



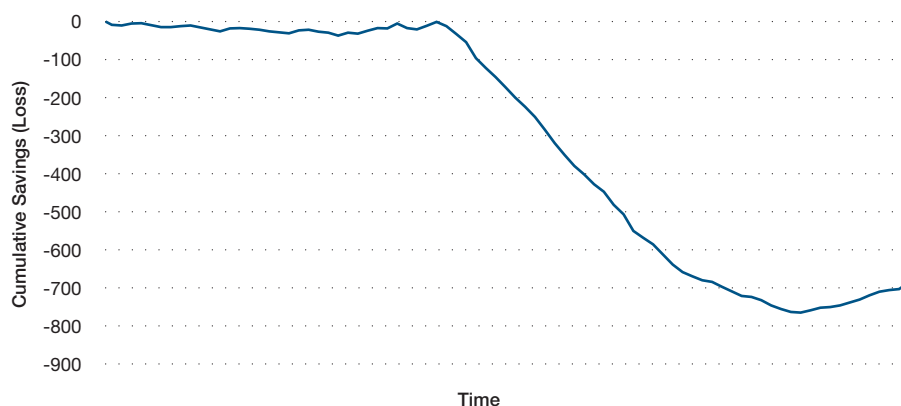
2.3.6 Evidence of Success

The EMIS must clearly show that actions taken to reduce energy use and costs have been successful (or not!). This is to justify ongoing investment in the systems, validate energy-saving decisions, demonstrate the improvements achieved and satisfy regulatory and voluntary reporting, etc.

To do this, there should be a benchmark – a value for energy use that can be compared with current usage. The benchmark must take into account external influences on energy use (production, ambient temperature, etc.). Typically, the benchmark is a model built from historical operating data. Regression is sometimes acceptable, but analysis techniques that are further advanced are more often needed (see Section 8).

A cumulative sum (CUSUM) graph can show improved performance effectively.

Figure 11. Graph showing cumulative savings achieved since an EMIS was installed



2.3.7 Support for Energy Budgeting and Management Accounting

An EMIS provides information to facilitate budgeting. Historical relationships between production and energy use can be used with production estimates to forecast future energy use.

The EMIS will also provide a breakdown of energy use and cost by product, process or department in order to

- improve management accounting;
- determine the true cost of energy, for example, to make specific products; or
- understand the impact of production volumes on energy cost per tonne of product.



2.3.8 Energy Data to Other Systems

An EMIS may also provide energy data and models to other systems. Examples are production planning and scheduling systems, energy, resource planning systems, management information systems, corporate systems and environmental reporting, etc.

2.4 What Are the Elements of an EMIS?

An EMIS comprises a number of elements that are integrated to form a complete solution. These elements include sensors and instruments, data infrastructure and software tools. Typically, separate suppliers will provide individual modules of the system.

As far as possible, EMIS components will be the same as those used to operate and manage the plant and process performance more generally, i.e., the performance management information system. There is a danger in developing an independent system for energy alone, and this approach has resulted in failures in the past. Energy use efficiency is only one aspect of process (and business) performance and should be considered in conjunction with other business objectives such as output, yield, quality, reliability, environment and **profit**.

In addition to hardware, the EMIS includes management systems to ensure that performance improvements are achieved.

It may well be that the elements of an EMIS already exist within an organization but are not employed to manage energy use.

Sensors and instruments include energy meters (electricity, gas, oil, steam), other utility meters directly associated with energy use (heat flow, cooling flow, compressed-air flow) and temperature, pressure, flow, composition and similar devices used to measure factors that influence energy use.

The sensors and instruments will usually be connected to a monitoring system, which should always be the monitoring and control system used for the process generally. This may be a distributed control system (DCS) in larger installations or a SCADA/PLC installation. In commercial installations, building management systems are used that are similar to SCADA/PLC.

Data collection should be automated. A data historian that is designed for time-series data storage is typically used. Manual data collection is considered all but obsolete.

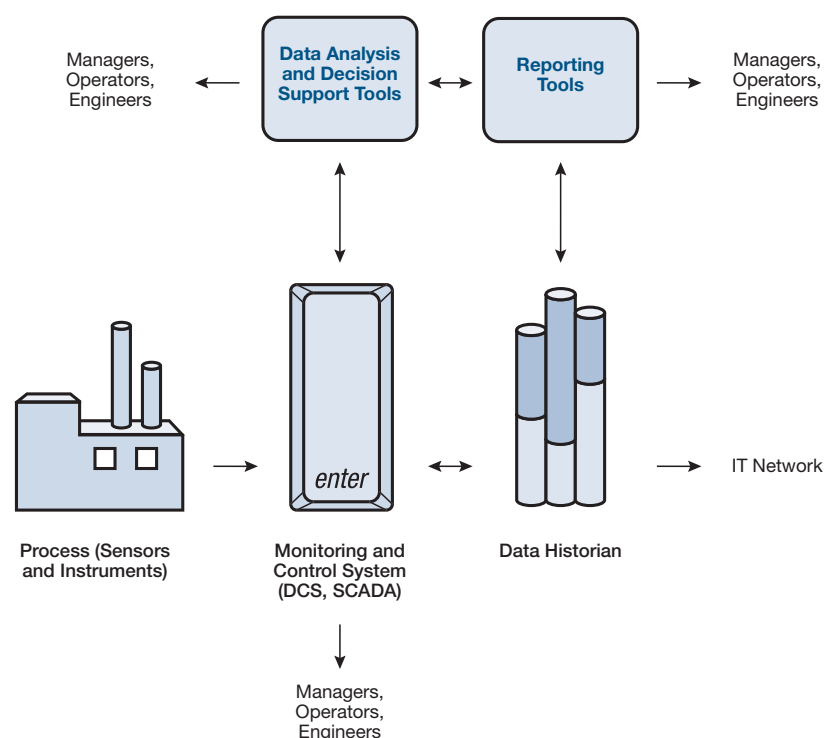
Software tools that form an EMIS typically integrate directly with the control/monitoring system and data historian. These include:

- data analysis tools
- reporting tools
- monitoring software
- optimization and decision support software



Interfaces between these tools and the control/monitoring and data historian systems are standard and generally simple to implement. Typically, the EMIS and process monitoring and management infrastructure will be networked with the corporate IT systems. Figure 12 illustrates the elements of a typical EMIS.

Figure 12. Elements of a typical EMIS



2.5 Solutions for Different Circumstances

The features, benefits and elements of the EMIS should be appropriate to the specific site. At a larger, energy-intensive site where there is a modern monitoring and control infrastructure, all the capabilities described in this handbook will be needed. At a smaller site, however, there may be a case for less comprehensive instrumentation, less frequent monitoring and reporting, and less sophisticated analysis of data. This handbook allows readers to choose system elements that are appropriate for their situations. The optimum solution depends on

- the importance and level of energy cost savings achievable
- the rate at which faults can develop and the time required to act on them
- the existing infrastructure that the EMIS can utilize
- the capital available for investment in the EMIS



Many companies that have developed a vision for an EMIS are obliged to move ahead in stages, earning the capital for the next step from savings realized. In terms of system requirements, there is little difference between an EMIS that is used in the industrial sector or the commercial sector, although its implementation may differ. For example, monitoring in the commercial sector will typically involve the building management system, and more responsibility will rest with facility operating personnel to reduce energy use, although feedback from building occupants should be factored into consideration.

Multi-site organizations may want to introduce a corporate EMIS to report centrally and analyse the organization's energy performance as a whole. To achieve this, data historians at each site should be linked, and the analysis and reporting tools should be able to access the combined data. There may be an additional central database of selected information. In addition to providing corporate energy reports (total company energy use vs. targets, for example), it may be possible to analyse corporate data to reveal higher-level patterns in energy use. For example, where several sites operate processes that are similar, it may be possible to find best-practice operating systems and conditions, optimum maintenance, best contractors, best equipment types and suppliers, etc. Advanced data analysis is discussed in Section 8.



What Makes an EMIS Successful?

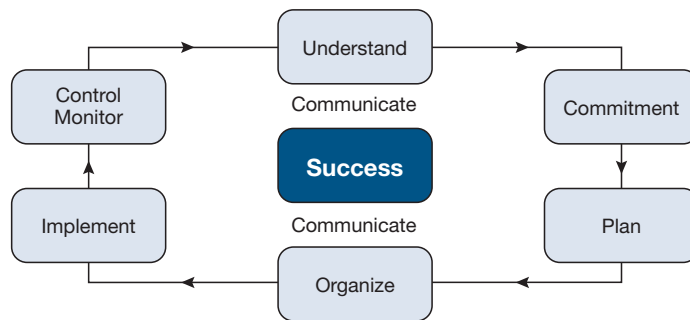
Overview

This section identifies some of the critical elements that should be addressed if an EMIS is to be successful. As stated in Section 2, an EMIS is only one element of an energy management program. Energy management requires the same sound business practices that are applied to finance, production, marketing and administration.

Energy management will deliver sustainable results when there is a clear direction that is embedded in the company's long-range business plan (i.e., policies, objectives, personnel and financial resources).

Sustainability can be achieved only through commitment at all levels of a company's organization – from the board of directors, the president, senior management, operational staff and administration. As shown in Figure 13, the first step toward commitment is understanding. What is not understood will not be supported!

Figure 13. Steps toward achieving success



Although an energy management program and an EMIS are intrinsically connected, there is an important distinction between them. An EMIS provides information; an energy management program takes action and returns results. It is important to recognize the difference when evaluating an organization's situation.

3.1 Elements of Success

The following elements directly influence how successful an EMIS will be:

- 3.1.1 Management's understanding and commitment
- 3.1.2 Company policies, directives and organization
- 3.1.3 Program responsibilities
- 3.1.4 Procedures and systems
- 3.1.5 Project selection and focus
- 3.1.6 Approved budget
- 3.1.7 Approved investment criteria
- 3.1.8 Training
- 3.1.9 Integrated information systems
- 3.1.10 Reports on savings achieved
- 3.1.11 Motivation
- 3.1.12 Marketing

3.1.1 Management's Understanding and Commitment

To achieve any sustainable energy initiative, it is essential to have senior management's visible and active support. This may seem obvious, but it is routinely identified as a major barrier in establishing and maintaining a serious energy management program. Among the reasons for lack of support are:

- The CEO, president and/or board of directors are unaware of the financial benefits that a corporate-approved energy management initiative will have on the balance sheet.
- Senior managers may not be convinced that new initiatives that are part of the company's strategic business plan will be of benefit.
- Previous initiatives have failed to deliver the targeted improvements.

The company's energy manager should consider the following:

- Is senior management being provided with factual and justifiable information upon which they can base their commitment?
- Does senior management receive reports on time and in the required format?
- Are the reports part of the company's Executive Information System (EIS)?

Remember, it is senior management that establishes policies, objectives and associated budgets, not middle management or a designated energy manager (see Sections 5 and 6, especially Section 6.5, "Obtaining Support From Decision-Makers").

3.1.2 Company Policies, Directives and Organization

To ensure that energy use efficiency becomes an integral part of a company's business plan and not just a side issue or ad hoc initiative, a clear set of policies, directives and organizational structure must be developed and approved at the most senior level. Specifically, there should be

- a clear energy use efficiency corporate or company policy statement that specifies energy goals and objectives



- an approved organizational structure and commitment to improving energy use efficiency
- a strategic action plan and time frame
- a strategy and plan to involve all employees by seeking their input and involvement

Energy management is first and foremost a management and organizational effort. Without proper attention, the program will have only marginal success or fail altogether.

3.1.3 Program Responsibilities

Because successful energy management is people-oriented (the more people involved, the more effective the program), the efforts of everyone involved must be structured and planned. The following can be considered a management equation for improving energy use efficiency:

$$\text{Responsibility} = \text{Accountability} + \text{Authority}$$

An assigned responsibility implies accountability. If these two parts of the equation are valid, then the person must have the authority (including an approved budget) to achieve company-approved objectives, goals and targets.

In smaller organizations, it may be that management is responsible for reducing energy consumption as part of its regular management duties.

In larger companies, an energy manager or coordinator must be assigned to be fully responsible for any initiative and be accountable to senior management for its success. Ideally, the individual should be an experienced line manager with some project management background and be people-oriented.

Although fully responsible for an organization's energy initiative, an energy manager obviously cannot work in isolation. The next step is to establish an energy management committee that should include staff from each major energy-using department, including representatives from operational staff, plant maintenance, engineering and finance. In most cases, the energy manager or plant energy coordinator chairs the committee.

3.1.4 Procedures and Systems

Procedures and systems are very important areas that must be challenged and reviewed. Often there can be significant initial low- or no-cost savings.

*Who? What?
Where? When?
How? Why?*

A well-structured EMIS will identify what areas should be reviewed, inspected and audited. It will also help managers and operational staff understand how answers to these questions will improve energy use efficiency. Challenge operational staff by asking, "If there were no financial or physical restrictions, what changes – operationally and financially justified – would you recommend?"

3.1.5 Project Selection and Focus

An efficiency initiative in one area or process will inevitably affect another.



3.1.6 Approved Budget

In today's business environment, there is significant internal competition for financial and human resources. An energy management program will be effective only to the degree that funds and personnel are available to develop and maintain it. It is therefore essential that the energy manager and the energy management committee develop a cost-effective business plan for senior management's approval.

3.1.7 Approved Investment Criteria

It is of little value to pursue initiatives or projects that require capital expenditures if the company's position is not clearly identified and understood.

- First cost: It may be company policy to obtain the best price for new or replacement capital equipment instead of also considering the long-term energy cost.
- Life-cycle cost: The company should consider the operating efficiency (cost) of the equipment during its life cycle.
- Payback period: If it is company policy to have an 18-month period for repayment of initial investment, it is unrealistic to prepare a proposal that has a payback period of, for example, three years.

3.1.8 Training

Training is often forgotten, under-emphasized and under-funded. Unless operational managers and plant staff receive adequate training on new techniques and equipment, many of the projected savings will not be realized.

For example, even though computers are now commonplace in today's working environment, not everyone is computer literate. Because equipment and controls involve computers, training in this area is important and will return value quickly. New techniques in other areas also require training.

3.1.9 Integrated Information Systems

Company information systems must be integrated so that data can be shared among departments. A company may maintain a number of databases, some of which may contain duplicate data. Managers and staff must not feel that if they share data it will somehow infringe upon their area of responsibility. The data belongs to the company, not to individual managers or departments.

3.1.10 Reports on Savings Achieved

Make certain that every saving achieved is recorded and reported to senior management. One of the major barriers to maintaining senior management support is irregular reporting. Relevant information should be forwarded to all company personnel relative to their area of responsibility or involvement. They contributed to the savings and should be apprised of what their efforts have accomplished.



3.1.11 Motivation

Motivation is a key factor in everyone’s workday. Regular formal or informal communications of the objectives, goals, targets and achievements is a considerable factor in the success of an energy management program. Remember that energy management depends on people. Their participation and motivation to contribute to its success are essential – don’t forget them!

3.1.12 Marketing

A company’s image regarding energy and environmental issues is becoming increasingly important. Some companies are already reporting to governmental agencies what energy and CO₂ emissions reductions they have achieved, and they’re also telling their customers and clients. They rightly take pride in documenting and publishing their success stories. Companies want the public to know that they are good corporate citizens – that they are improving their energy use efficiency and reducing greenhouse gas emissions that contribute to climate change.

3.2 Evaluation

It is important to evaluate a present Energy Management Program (EMP); this will also serve to distinguish between an EMP and an EMIS (see Section 2). Tables 2 and 3 will help with evaluating your organization’s corporate energy management program.

Table 2. Success matrix

Factor	Assigned Value	Weighting Factor*	Present Assessment	Improvement Target
Management commitment	20			
Company policies, directives, organization	10			
Program responsibilities	10			
Procedures/systems	5			
Project selection and focus	15			
Approved budget – financial and other resources	15			
Approved investment criteria	3			
Training	5			
Integrated information systems	5			
Achieved savings are reported	5			
Motivation	4			
Marketing within and outside company	3			
Total	100			

*Weighting Factor Multiplier
 No action: 0 percent
 Weak initiative: 25 percent
 Average initiative (including some weaknesses): 50 percent
 Adequate initiative: 75 percent
 Excellent initiative: 100 percent



Table 3. Evaluating a corporate energy management program

Scale	Energy Policy	Organization	Budget	Investment	Information Systems	Training and Motivation
4	<ul style="list-style-type: none"> • Signed and published policy • Detailed action plan • Evaluation and review process as part of corporate business plan and integral to corporate business strategy 	<ul style="list-style-type: none"> • Energy management assigned to senior manager • Line manager's responsibility and reporting is part of job description • Senior management actively participates 	<ul style="list-style-type: none"> • Energy deemed an operating cost, with specific corporate budget by responsibility or operational cost centres 	<ul style="list-style-type: none"> • Favourable investment is applied to all new, replacement or upgrades of equipment, systems and procedures regarding energy • Environmental policies • Life-cycle cost analysis 	<ul style="list-style-type: none"> • Comprehensive EMIS monitors consumption, faults, solutions and savings vs. budget • Integrated with corporate main information system 	<ul style="list-style-type: none"> • Regular upgrading of staff's technical skills • Reports and marketing of results internally and externally via newsletter on other regular publication(s)
3	<ul style="list-style-type: none"> • Formal policy and action plan but is not part of corporate business plan • No active commitment from senior management 	<ul style="list-style-type: none"> • Appointed energy manager reports to a senior manager • Energy committee of major energy users established and chaired by plant energy manager 	<ul style="list-style-type: none"> • Funding approved on a project-by-project basis from general operating budget • Prioritized by energy committee and approved by plant energy manager 	<ul style="list-style-type: none"> • Same payback criteria as for all company investments 	<ul style="list-style-type: none"> • Monitoring and control systems based on sub-metering • No tie-in to corporate system • Savings not reported effectively to management and other staff 	<ul style="list-style-type: none"> • Limited training/awareness programs • Results are publicized internally and externally
2	<ul style="list-style-type: none"> • Unofficial policy established by energy manager or senior departmental manager 	<ul style="list-style-type: none"> • Energy manager appointed and reports to ad hoc committee • Unclear line of authority 	<ul style="list-style-type: none"> • Must compete with other company operating/capital requests or initiatives 	<ul style="list-style-type: none"> • Short-term investment only 	<ul style="list-style-type: none"> • Cost reporting based on meter reading or utility reports retained by individual manager 	<ul style="list-style-type: none"> • Some ad hoc training and awareness initiatives
1	<ul style="list-style-type: none"> • Unwritten policy or guidelines 	<ul style="list-style-type: none"> • Energy management is a part-time responsibility • No line authority or real influence 	<ul style="list-style-type: none"> • No specific funding available 	<ul style="list-style-type: none"> • Low- or no-cost initiatives only 	<ul style="list-style-type: none"> • No information system used to unofficially track energy consumption 	<ul style="list-style-type: none"> • Limited and informal training
0	<ul style="list-style-type: none"> • No stated or implied guidelines 	<ul style="list-style-type: none"> • No responsibility 	<ul style="list-style-type: none"> • No funding 	<ul style="list-style-type: none"> • None available 	<ul style="list-style-type: none"> • No accounting for energy consumed 	<ul style="list-style-type: none"> • No contact with staff

Real-Time Data Is Required

What Is Real-Time Data?

Real-time data is collected automatically at predetermined intervals. For a similar cost, measurements can be recorded every day or every second. To be useful, however, the frequency of data collection should

- be sufficient to allow problems and remedies to be identified in time to save energy (i.e., before the problem is over and the process has moved to another operating mode)
- be more frequent than the fluctuations in energy use that need to be understood (at least twice the frequency)
- should not be so frequent that changes are due to control system variations rather than true variations in energy performance

Low-frequency data produce crude targets and have caused some systems to fail. If a manager cannot see the effect of his or her actions on performance, system credibility will be lost. No savings will be achieved other than those that tend to follow the implementation of any EMIS and/or M&T system because of its sole focus on energy savings. These savings, however, are well below what is possible and typically will not be sustained. An EMIS should operate in real time for the following reasons:

- A real-time system will identify poor performance (i.e., a problem) sufficiently quickly for action to be taken.
- Real-time data can provide a better understanding of historical operations.
- Real-time data can produce better targets (models).
- Real-time information is better for activity-based costing.
- Real-time energy data is consistent with data collection to manage general process performance (energy, yield, etc.), and integration with these systems is key.

Identifying poor performance quickly allows staff to correct the problem and achieve energy savings. Contrast this with a system that simply tells the user that a problem occurred yesterday or last week; the operator is left knowing that an opportunity has been missed and is faced with the problem of making sure that the next problem is identified through real-time monitoring.

Contrast a profile of energy demand with a single value for total energy used. Figure 14 shows the various modes and blips, revealing important patterns and providing a basis for more comprehensive data analysis (see Section 8).

How Can Action Ensure Improvements?

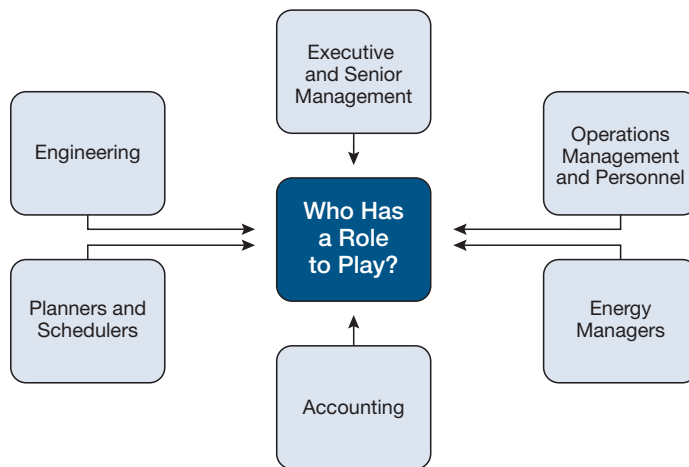
Overview

There is little value in initiating an EMIS if action is not taken on data analysis results. This section focuses on how to ensure that the EMIS is acted upon so that savings are achieved. Also outlined are who should take action, how and when they should act, and what they need to ensure that they take action.

5.1 Who Should Take Action?

Action to achieve improvements is best ensured by an organizational culture that encourages, rewards and sustains initiatives that reduce utility costs. Although an EMIS supplies useful information about a site's consumption patterns, "people skills" are needed in order to effectively communicate, encourage and involve personnel in effectively achieving results.

Figure 15. EMIS impact on organizational structure



As illustrated in Figure 15, using an EMIS as a support tool to encourage action affects a site's organizational structure. Depending on the company's type of business, management and personnel will each fulfil a different role when taking action. The downward and upward exchange of information and data between senior management and operations comprises an open structure that is crucial in order to ensure action and success.

Top management can ensure action by

- clearly stating its energy policy (i.e., define the organization's initiatives in energy use efficiency)
- informing the organization's employees and the general public of its commitment to energy use efficiency and associated cost reduction
- appointing a responsible authority (usually the energy manager) to ensure action

Operations management can best ensure action by involving those who have the most impact on energy consumption. Ultimately, it is operational personnel who take actions to meet energy use efficiency targets and who are accountable for the effectiveness of their efforts. An EMIS is based on transferring responsibility for performance efficiency from those who have limited influence on energy consumption (utilities and physical plant managers) to those who have the greatest influence on performance (the end-user who operates the process).

Actions taken to achieve energy savings will indirectly involve the planning and scheduling, accounting and engineering departments. Any proposed energy use efficiency initiative should be communicated to these groups as early as possible.

5.2 What Is Needed to Take Action?

Reliable and useful information is needed in order to take appropriate action.

Key aspects include

- 5.2.1 Energy data
- 5.2.2 Targets
- 5.2.3 Reports
- 5.2.4 Training
- 5.2.5 Decision support
- 5.2.6 Audited success
- 5.2.7 Motivation and recognition
- 5.2.8 Benchmarking and best practices

5.2.1 Energy Data

Good monitoring information provides a firm foundation to intelligently select measures to be implemented. Additional sub-metering may be needed to provide sufficient data and a basis for action. Data should not be "thrown at" an EMIS with immediate results expected; regard the EMIS as a tool to be engineered into a solution. The capabilities and limitations of an EMIS should be well understood before applying its findings.

5.2.2 Targets

Comparing current energy performance with targets prompts action to improve energy use efficiency. Simply monitoring energy use will only incur capital costs and will not result in cost avoidance.



Targets are calculated from an equation that represents the link between monitored energy consumption and its influencing factors (outdoor temperature, operating hours, production rate, hours of occupancy, etc.). The target equation is derived from statistical analysis or from measured data. To be meaningful and reliable, targets must be

- regularly reviewed (at least quarterly)
- established in line with a definite action plan
- established only after the desired level of monitoring is in place and meaningful data has been confidently obtained
- realistic but not too easy to achieve

Consistently setting appropriate targets will ensure continuous improvement in results and help motivate personnel who influence energy use. Poor target setting can destroy confidence and lead to eventual failure of the EMIS. Several factors affect the target-setting process and the ability to translate information into action. These include the following:

- Identify and agree to desired targets. Keep in mind the justification for the application, and limit the effort to match the desired goals. Do not attempt to monitor the entire site if a preliminary evaluation anticipates that the major benefits will probably come from only one or two areas. Try to keep targets as simple as possible, but no simpler.
- Management personnel cannot support or commit themselves to something that they are not aware of and/or do not understand. Targets should be explained and be agreed to by senior management.

5.2.3 Reports

Reports should be circulated to advise when targets have been met or exceeded and when they have been improved upon. These can serve as motivation tools and should be clear, credible, timely, appropriate and informative. Don't overwhelm the intended audience with too many facts and figures.

The level of detail in reports must be tailored to the intended audience. Executives typically need only a performance overview. Senior management requires similar information that has slightly more detail and compares energy use with targets. Operational managers and their personnel need detailed information. Reports to them should include energy profiles and key influencing factors, which will offer more specific information and help them diagnose faults.

5.2.4 Training

In order for appropriate actions to follow the implementation of an EMIS, personnel must understand the reports that are being generated and what actions they should take. This requires staff training and team building. Training must:

Good target setting motivates; bad targets destroy confidence.

The importance of training and documentation support



- impart a clear understanding to site personnel of the impact that utilities have on a plant's operation and that utilities represent a controllable cost
- use simple graphs, visuals and handouts to illustrate an overview of the site's utilities history and provide a reference to set future goals and targets
- help staff work together as a team and recognize opportunities to reduce energy costs throughout the site
- motivate staff to encourage their fellow employees to become actively involved in efforts to reduce energy use
- emphasize that when a problem occurs, it is regarded as a team problem that needs team support – individuals will not be left to sort out problems by themselves

5.2.5 Decision Support

As already stated in Section 3, effective implementation of energy use efficiency measures must involve various units within an organization. Creating a decision support committee for the responsible authority (i.e., the energy manager) can provide a framework for obtaining agreement on actions that may affect more than one operating unit. This committee could also foster communications between various departments and offer a stronger voice when approaching senior management for project approval.

5.2.6 Audited Success

Motivation will be sustained when a team has early successes with proven results, as validated by the EMIS. Credibility will also enhance motivation and obtain buy-in from all personnel.

5.2.7 Motivation and Recognition

Ways to reward good performance can be developed by an organization's human resources group. This may involve giving recognition through publicity (e.g., testimonial posters, newsletters, non-monetary awards at company events, etc.) or a modest cash award. Motivation will also be enhanced when staff is assured that help is available from the team to correct poor performance.

5.2.8 Benchmarking and Best Practices

Comparisons derived from a benchmarking exercise can provide a catalyst for taking action to improve energy performance and reduce costs.

Although the target review process will help a facility gain insight into its operations and utility cost performance, many organizations want to understand how their performance relates to other sites within the company or with their competitors. Benchmarking offers a tool for managers to measure their organization's performance in relation to others. It also provides an excellent learning opportunity. Improvements in



utility consumption derived from EMIS knowledge can instigate a set of best practices. There are significant benefits from having all areas of an organization use best practices determined from another area of the organization or another industry player.

An organization that is interested in benchmarking must

- first decide which methodology it wants to use as a basis of comparison (e.g., energy consumption per total raw feedstock processed or energy consumption per total refined product)
- determine whose operations it intends to use as a benchmark
- do its homework and arrive well prepared (this is a prerequisite to getting other organizations to partner with you in a benchmarking effort)

Candidates for benchmarking can be determined through trade associations, journals and contact with colleagues. Most companies that are approached to share data are receptive to benchmarking, although some may be reluctant for competitive reasons.

Understand the data you need and the results you want – compare apples with apples.

Companies that understand that they are being approached because they are recognized as being best in their class will often agree to share information. Most companies, however, will not agree to an exchange of information with another company that has not looked at itself first.



How Is an Effective EMIS Designed and Justified?

Overview

This section outlines how to take a structured approach when designing an effective EMIS. Discussed are creating a vision, developing a case and gaining support to implement that vision. Key points are summarized at the end of this section.

6.1 Creating a Vision of an Effective EMIS

A company needs a clear vision if it is to invest in an EMIS. Factors that influence the decision to begin an EMIS project include

- a need to reduce greenhouse gas emissions
- the realization that utility costs are controllable and not fixed overhead expenses
- effective negotiation of utility contracts based on a sound understanding of a facility's or plant's energy use profile
- the need for real-time fault diagnosis, product quality control and the ability to challenge plant performance

The following points should be considered before designing an EMIS.

6.1.1 Address Site Needs

Implementation must address the needs of the site; otherwise the site is buying into a "system," not a management tool. This involves clearly identifying performance measurements that are relevant to the operating strategy of the site.

An EMIS must suit the site, involve process personnel and offer real-time data.

6.1.2 Usefulness of the System

It is necessary to clearly understand how the EMIS will be used and how it will directly or indirectly result in utility cost avoidance. The EMIS must be useful if it is expected to remain in service for several years. This means that it must gather the collective and accumulated experience of a site's operations without having to relearn it. This involves

- gathering and storing a considerable amount of information, organizing it logically and making it accessible with limited effort within reasonable response times

- being flexible enough to accommodate the requirements of a main site in a multi-site organization but also address a unique requirement of a remote site if the load is sizable and represents a constraint on the overall operation
- encouraging collaborative activity and assisting analysis and decision making

6.2 Beginning Design: Consider Measurement Issues

Once a clear vision of how the EMIS will be used is established, details on energy use measurement need to be worked out. To ensure that an effective system is implemented, an EMIS design should be based on two key facets:

- prominent involvement of the person who is in charge of the process
- the presentation of performance measurements in real time

There is little value in designing a sophisticated energy monitoring system that measures consumption too coarsely. Similarly, measurements will be of no help if they are so detailed that it is difficult to determine what historical energy consumption was for a specific area and why it differed from previous values. In practical terms, the person who is in charge of the process best answers this. An effective system also provides tools to the people who are actually processing the product so that they can receive performance indicators during the process and respond appropriately.

The essence of an EMIS is to compare real-time utility consumption with historical records and set targets (e.g., the energy consumption of the present process batch vs. the previous one). Until these two attributes are designed into an EMIS, the site will ultimately be left with a “rearview mirror” syndrome that offers information that no one will have time to go back and review.

It makes sense for the person who is responsible for the process to be assigned the tasks of collecting energy and process data and explaining the performance in real time. Alternate personnel are not likely to have the required knowledge, and they would have to consult closely with the process person in any case.

The degree to which energy use is measured must be factored into the design of the EMIS, and this is subject to the usual trade-off of cost vs. need. If, as a result of insufficient measurement, energy use is not broken down into the same size “pieces” on which the process is managed, the plant will have difficulty introducing the accountability required to effectively manage energy use.

To counter any concerns that an EMIS means needless micro-managing, experienced process operators generally recognize the difficulty of managing a process simply by looking at the total feed-in and comparing it with the total product out every month. It is not unusual for a process vessel to be instrumented with equipment, valued at a range of \$100,000 to \$200,000 and dedicated to micro-managing that part of the process. This is inherent in process control; yet, this approach is rarely applied to energy control with the same regard. If the plant is serious about developing metrics,



challenging current practices and reviewing energy consumption as part of the regular cost review process toward energy management, it should know its energy consumption per unit of product for every process area, at least on a daily basis.

6.3 The Next Step: Consider Integration Into Existing Systems

Careful consideration of how the EMIS will fit into existing management systems on-site must be part of the overall design process. The continuing reduction in the cost of data processing, the increase in available communication bandwidth, and the ongoing improvements in search-engine software encourage the integration of an EMIS within existing IT systems. Many sites already employ a variety of DCS and SCADA systems, enabling a large portion of existing hardware and infrastructure to be used in the design of a new EMIS.

Use existing infrastructure as much as possible.

Since the requirements of an EMIS are likely to be broader than an existing IT system, implementation will probably require additional input or output variables. This could be accomplished with relative ease by adding supplementary field (end) devices such as sensors, tying the signals to spare input cards and applying some reprogramming.

Beyond data acquisition and monitoring and control issues, the design must evaluate which attributes of the management systems, ISO requirements, procedures, etc. that are presently in use can be linked to a new EMIS. The purpose of this evaluation is to gain insight into how the existing systems are used within an architecture that typically integrates data, functions (e.g., analysis, document management, simulation tools, search engine, etc.) and presentation. An understanding must also be gained of the operation of the corporate networks that support this architecture, including intranets, extranets for utility and supplier connections and links to the Internet.

Since all plants have cost accounting systems, the EMIS must effectively mesh with what is currently in place to ensure that energy management is integrated within the core of the business and not relegated as a sideline issue.

It is important to realize that barriers to implementation usually have more to do with cultural and organizational issues than technical issues. Creating a knowledge-based team will require more than supplying software, large databases of information and hardware. Issues that should be addressed when considering the interaction of people and technology include the following:

Consider the interaction of technology and people.

- Existing data that is inconsistent throughout the company should be reconciled before designing an EMIS. Uniform data is a key requirement in a data-sharing environment.
- It will be difficult to encourage people to share information when an organization's culture ranks their employees strictly on individual performance. Foresight will be needed in order to deal with common perceptions that capturing and disseminating knowledge will reduce one's future value to the organization ("Why will I be needed?")



or “Will someone else get all the credit if I share information?”). A collaborative attitude can be fostered within an enterprise when knowledge-sharing contributions and team efforts are recognized in performance appraisals.

- Focusing on technology alone cannot overcome an unwillingness or inability to communicate information across boundaries in hierarchical structures. Plant management must consider who should have complete access to information so that informed decisions can be made during plant operations.

6.4 Prepare a Supporting Case: Cost/Benefit

It is difficult to estimate with certainty the annual utility cost savings that will result from implementing an EMIS. Over the past 15 years, significant development work has been undertaken in the UK. Results indicate that, when properly implemented, an EMIS can save 5 to 15 percent of annual energy costs. As an initial approximation, 8 percent appears to be a reasonable estimate. A more refined estimate of savings can be developed by conducting a “front end” energy survey to assess the extent of a site’s controllable loads and potential reductions through improved operating practices as a result of meaningful, timely information. The results of the survey can be used to identify the areas of greatest energy use and potential savings should it be decided to implement a targeted pilot project with reduced scope before full implementation. In this case, EMIS software (database, graphics, reports, historical archiving and trending) and hardware components (processing power, network bandwidth, disk and memory, and printing) should be designed with sufficient expansion capability for future requirements without requiring a process interruption.

The amount of expenditure that can be justified to implement an EMIS should be proportional to the site’s annual utility costs. This forms the reference point from which the potential energy cost savings can be estimated. Although there are no definitive rules for arriving at a justifiable expenditure, the ranges of cost (based on experience in the UK) outlined in Table 4 can be used as a guideline.

What amount of expenditure can be justified?

Table 4. Approximate justifiable EMIS capital cost

Annual Utility Costs	Approximate Justifiable EMIS Capital Cost
\$125,000	Up to \$25,000
\$250,000	Up to \$40,000
\$600,000	Up to \$50,000
\$1,250,000	Up to \$150,000
\$2,500,000	Up to \$200,000+



The order of magnitude range of costs outlined in Table 4 will cover various levels of hardware and software purchasing. For example, expenditures of up to \$150,000 would encompass a modest number of meters, analysis spreadsheets and perhaps basic data acquisition software and hardware at the upper cost range. Expenditures of greater than \$200,000 will cover a greater degree of metering, data acquisition software and hardware, data analysis tools and networked systems, etc.

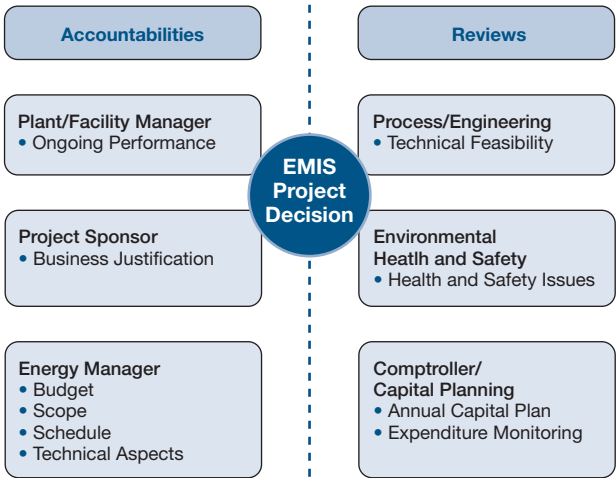
It should be emphasized that beyond the initial installation costs, there is also an operating cost associated with an EMIS (including time and maintenance costs) that should be considered when justifying a project. In addition, capturing lessons learned from the data-gathering process and keeping them current with changes in the business environment will entail ongoing support costs, requiring time and money that should be anticipated and budgeted for.

Having considered aspects of cost/benefit analysis and refining the design development to achieve the required payback period, non-monetary benefits should also be part of the justification. For example, one important benefit of implementing an EMIS is that the organization can retain critical information that could otherwise be lost when personnel leave the company.

6.5 Obtaining Support From Decision-Makers

As outlined in the previous section, implementing an EMIS will involve many different operations and management units within an organization. The final stage in turning the initial vision into reality is to obtain support from key decision-makers. Because of the many players involved in the process, coordination is vital. The energy manager (or project manager) is usually the ideal person to coordinate and organize the submission that will be presented to senior management. Figure 16 illustrates the decision loop, including its key players and their corresponding objectives and drivers.

Figure 16. Decision loop accountabilities and reviews



6.6 Designing and Implementing an EMIS: A Checklist

The following summarizes a structured approach toward designing and implementing an effective EMIS. This checklist is intended to guide readers in finding their own solutions.

Yes	No		
<input type="radio"/>	<input type="radio"/>	Is there a clear definition of what the plant or facility wants to achieve?	Be clear on how the EMIS is to be used, how it will improve the management of utilities, and whether it will be financially viable.
<input type="radio"/>	<input type="radio"/>	Has it been determined how the EMIS will integrate with existing energy management and IT systems?	Consider what existing infrastructure can be used. This will require taking stock of the state of the plant's software, hardware, field devices, employee knowledge base, operations culture and hierarchy.
<input type="radio"/>	<input type="radio"/>	Have all the reports that are needed to meet the objectives and those to whom they will be directed been identified?	What do line staff and management each require? Identify what the reports should contain. What should the presentation format be (paper-based, DCS display, Web-based, etc.)? Beware of information overload, which could deter use of the system.
<input type="radio"/>	<input type="radio"/>	Is identification of data collection requirements necessary in order to meet reporting needs complete?	This is not limited to collecting energy consumption data. Focusing on influencing factors (degree-days, production levels, operating hours) and real-time data collection is important and encouraged. This will allow proper analysis of the factors that affect energy use and help diagnose faults. As much as possible, energy data should be collected by the same systems (SCADA, DCS and PLC) that collect process data.
<input type="radio"/>	<input type="radio"/>	Has it been determined how the data will be properly analysed?	There is no point in collecting data if it is not going to be properly analysed. Data analysis techniques (such as data mining) should reveal information about the relationships between the influencing factors and energy use and help to identify faults that are affecting energy costs. Predictive analysis could also be considered as an advanced feature. Increased efficiency is sure to result if the data analysis software can enable a process control system to reduce deviation from a desired set-point, increase throughput, decrease energy consumption or predict or rapidly diagnose faults.



Designing and Implementing an EMIS: A Checklist (continued)

<input type="radio"/>	<input type="radio"/>	Will the EMIS be marginalized as a sideline issue?	An EMIS should be integrated into existing monitoring and control systems and general IT systems. Information derived from the system should be presented to management along with business performance, production performance, etc. Considering energy alone will result in the EMIS being sidelined.
<input type="radio"/>	<input type="radio"/>	Has a budget allowance for support services been prepared and approved?	Ensure that the budget estimate includes an allowance for support services such as site commissioning, testing, training and site documentation, periodic technical assistance and troubleshooting.
<input type="radio"/>	<input type="radio"/>	Has a front-end energy survey followed by cost-benefit analysis been completed?	The eventual success of an EMIS will be gauged by its cost-benefit performance. A reasonable estimate of simple payback can be developed by completing a front-end energy survey to determine probable annual energy cost savings and budget grade estimates of capital expenditure (can be obtained by consulting with vendors).
<input type="radio"/>	<input type="radio"/>	Is there flexibility to refine the design as required?	Be prepared to refine the design in line with management's budgetary expectations. Extraneous metering, data analysis capability, data storage and report production capability may have to be pared back to reduce costs. Before committing significant capital expenditure and staging the implementation, begin with a pilot project so that expected savings can be proven and increase support for the project. Initial payback can be enhanced by selecting system applications in only those areas that have a high likelihood of yielding significant savings.
<input type="radio"/>	<input type="radio"/>	Is the preparation of a sound justification completed?	The capital allocation request process for most organizations will demand that a well-presented written and verbal case is made to senior management. This presentation should be factual, focusing on business goals, not technology.



Effective Energy Reporting

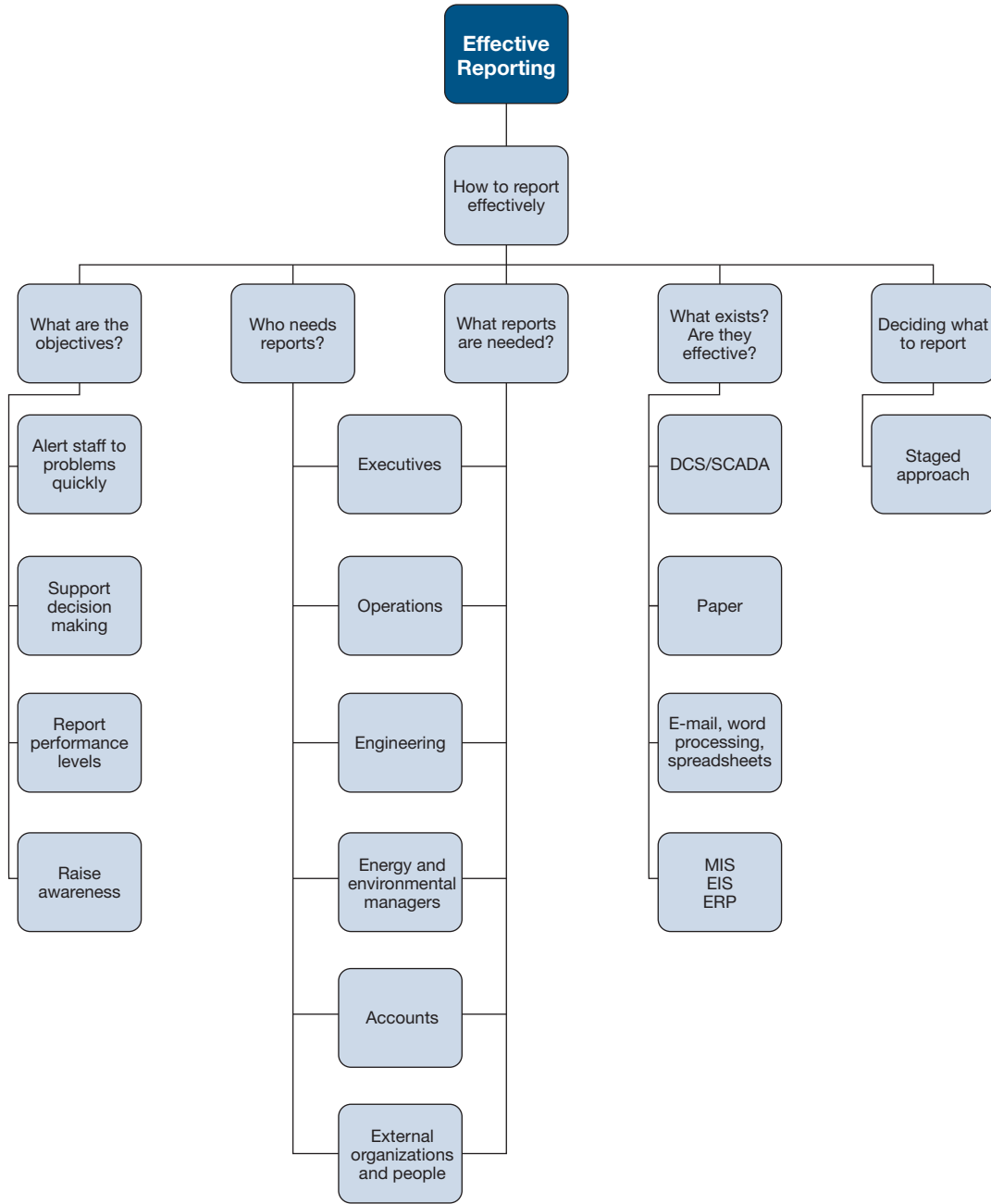
Overview

Effective energy reporting is an essential element of a successful EMIS. Reports are required for a range of individuals and departments in an organization, from operations personnel to the CEO. Each report must include relevant information in an easily understood format, and all data should be consistent.

The reports must provide information to enable the user to act. Operational staff needs to know when a problem has occurred as quickly as possible and know what they should do about it. Senior management, on the other hand, needs summary information to know that procedures and systems are working well. In order to design reports, it is important to understand who needs reports and why.

Existing reporting infrastructure should be used where possible. Graphical techniques can be used with company intranets and the Internet, and the Web can facilitate access to reports anywhere, anytime. Figure 17 summarizes the topics addressed in this section.

Figure 17. Effective energy reporting: Questions and answers



7.1 What Is an Effective Report?

The EMIS should include effective performance reporting to relevant personnel.

This is to

- ensure that staff are alerted to problems in a timely manner
- support effective decision making
- report performance levels internally and externally
- raise awareness and win support for energy management initiatives

A comprehensive EMIS will be targeted to a range of individuals and groups.

These might include

- executives
- operations management
- operations personnel
- engineering
- accounting
- energy and environmental management
- external advisors
- planners and schedulers
- ad hoc users

Reports will differ for each user, but all should be founded on sound data regarding actual process performance, a robust analysis and performance targets.

Data presented must be consistent, and often it makes good sense for all reports to be available to all staff (unless there are significant issues with confidentiality). However, the reports designed for each user should be limited to what he or she needs in order to effectively act. Avoid information overload; staff can consult reports that are more detailed if they choose.

Ideally, reports should be readily available where and when they are needed. A Web interface made available on the corporate/company intranet/network can be highly effective.

As a rule, reports should be tightly integrated into existing performance monitoring and management systems. For example, if operations staff relies on DCS or SCADA systems for information, display the results using these systems. If executives have an Executive Information System (EIS) that is used effectively, use it to communicate results. Similarly, use the corporate energy Web site if one exists.

Moreover, energy reports should be subsets of general performance reports. Energy is seldom, if ever, the sole improvement objective and should be considered with other factors such as output, quality and reliability. Companies exist to make profit, not to save energy, but the two are usually consistent with each other.



Before designing reports and selecting reporting methods, it is important to

- understand who needs reports and why
- understand what existing reporting systems are used and where energy reports could be integrated
- understand that needs will differ from one organization to another

Understand who needs reports and what existing systems are in use.

7.2 Who Requires Energy Reports?

Some of the individuals and groups that may require energy reports are discussed in the following, along with possible reasons and the use the reports will be put to.

7.2.1 Executives

Senior executives will have overall responsibility for energy performance and may well need to report on and explain performance levels to the board or to senior management. They will have delegated the task of managing energy performance and will want to measure the effectiveness of the performance of the responsible individuals.

The availability of sound data that is well presented and, ideally, that demonstrates a successful energy improvement initiative will keep energy high on the executive and management agenda and facilitate approval for expenditure and initiatives.

The executive will typically have little time to spend on energy issues and will require data presented clearly and simply that can be immediately understood. Detail will not generally be necessary. A standard format is a good idea – the chair of the executive board will become used to the information and will understand and expect it. The information might include

- a summary of last year's costs, broken down into key areas
- a summary of the current year's performance on a monthly basis
 - against budget
 - against the previous year
 - against targets
- a note of the savings (or losses) achieved to date and how they were achieved
- a note of additional savings opportunities and what actions are ongoing to address them

A new report should be issued each month and be available in time for board meetings (with time for the executive to include figures in his or her own reports and ask any questions).



The reporting method will vary from paper-based reports or electronic documents that can be easily incorporated into board reports, to computer-based systems. The executive may be using an EIS, be familiar with Web browsers or be familiar with a spreadsheet program or similar software.

7.2.2 Operations Management

Operations management will be responsible for operating processes and plant efficiency. They will need to know on a shift, daily, weekly or monthly basis (depending on the nature of the process and the level of energy use) what energy has been used and how this compares with various targets. The information will be used to

- measure and manage the effectiveness of operations personnel and process plant and systems
- identify problem areas quickly
- provide a basis for performance reporting (to executives)

The operations manager will typically require simple reports either via a Web interface, a word-processed document, a spreadsheet program or through an existing management reporting system. The information may need to be incorporated into existing process and plant performance reports.

7.2.3 Operations Personnel

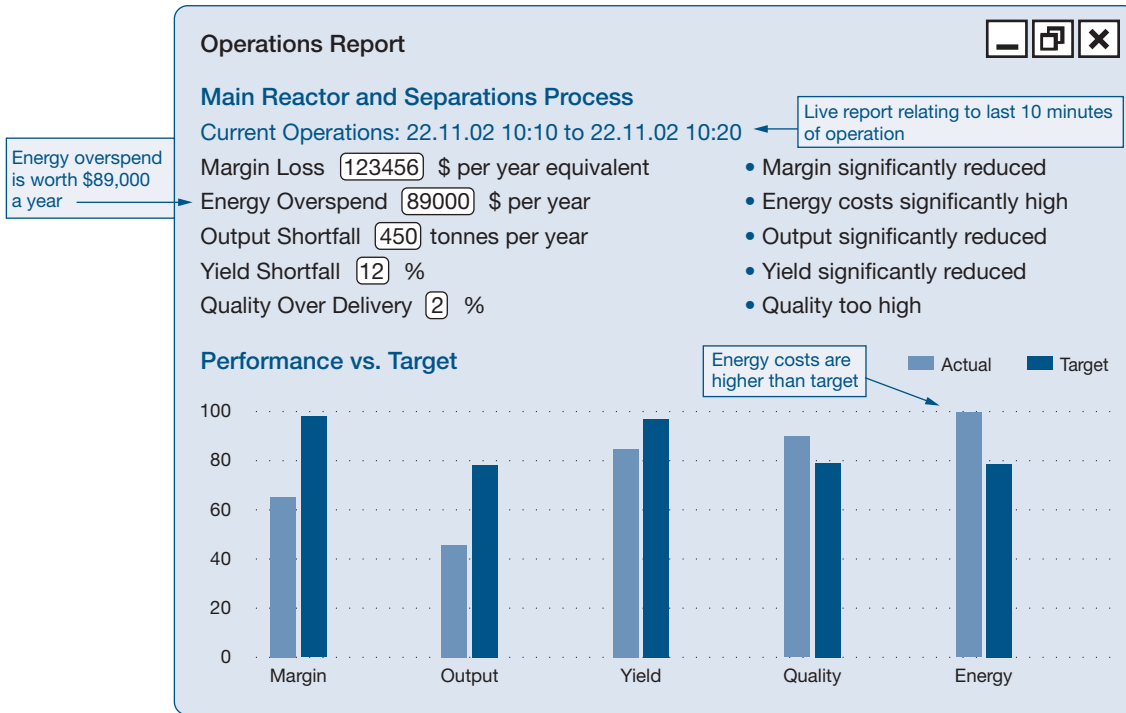
Operations personnel need to know when a problem has occurred and what needs to be done to rectify it. This information needs to be

- provided in a timely manner, which might mean within a few minutes of the event for a major energy-using process, or within a day or a week
- reported using a system that is easy to use and readily accessible (typically the DSC, SCADA or a Web browser interface)

Figure 18a illustrates an alert that energy performance has been poor over the last 10 minutes.



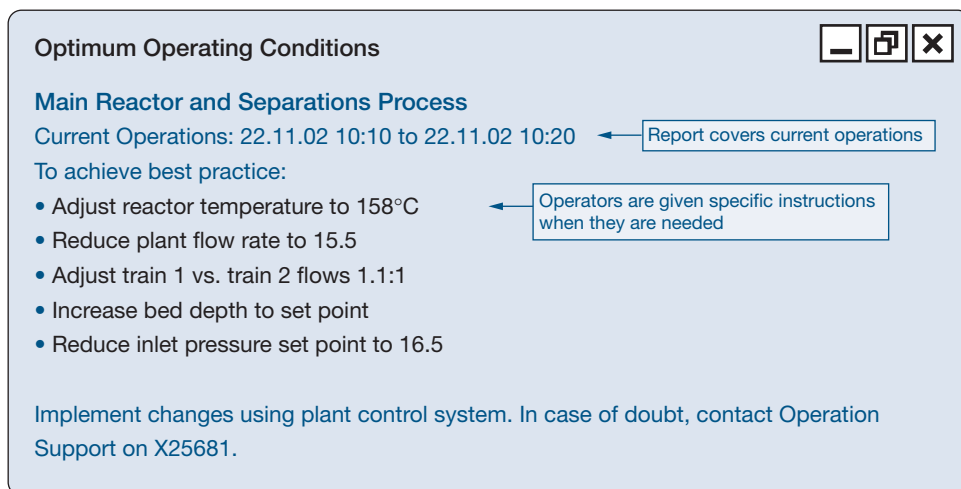
Figure 18a. Example of an operations report alert



The energy information should be presented alongside other key performance factors, as illustrated in Figures 18a and 18b.

Decision support solutions may also be required in order to instruct operators on how to respond to poor performance.

Figure 18b. Another example of an operations report alert



7.2.4 Engineering

Engineering staff has a number of roles, including operations, support and projects.

Engineers associated with operations will need reports similar to those for operations personnel (described in Section 7.2.3). Engineers may typically be involved with problems where there is more time to act (compared with process operators), for example, cleaning heat exchangers, solving a control problem or removing air from a refrigeration condenser.

Engineers who are not directly in operations but who provide support will need more detailed historical information. Typically, these individuals will be involved in analysing historical performance, developing targets and modelling. They will require access to the plant data historian and will use analysis tools, ranging from commonly available spreadsheet software to advanced data mining and similar software.

Engineers that are involved in projects will need supporting data, for example, levels of energy use, process operating conditions, etc. They will also need access to the raw data in the historian and access to analysis tools.

Energy data and associated analysis tools need to be well documented and supported.

7.2.5 Accounts

The accounts department may be interested in actual energy usages and costs to compare with budgets. They will need information that is broken down by department so that costs can be allocated to related activities. Accurate costing of operations and the cost of producing goods can improve decisions regarding product pricing, for example, and the allocation of resources.

7.2.6 Energy and Environmental Managers

Energy and environmental managers will need summary data that identifies the performance achieved and trends, much like what executives and operations managers require. Like engineers, they may require more detailed information for specific analysis.

The environmental department may want energy consumption expressed as equivalent CO₂ emissions, and the energy reports may need to be integrated into environmental reports that are more general. Summary information may be required for annual energy and environmental reporting and may be needed more frequently by regulatory bodies.

The energy manager may be involved in energy purchasing as well as efficiency. He or she may need information about the profile of energy use (using a half-hourly graph, for example), peak usage, nighttime usage, etc. The energy manager will also need access to the raw data in order to allow evaluation of purchasing options and to check bills.



The energy manager may also be responsible for managing tax rebates (e.g., the Accelerated Capital Cost Allowance provision 43.1 has a cogeneration performance requirement that must be assessed for regulation applicability).

7.2.7 External Advisors

External advisors such as consultants will need access to raw data for detailed analysis and to summary data.

7.3 A Staged Approach

Consider the following approach in order to design effective reports.

Identify the target personnel – these are people whose involvement can help to save energy. Determine their specific needs:

- understand the existing performance reporting systems in use
- evaluate the effectiveness and suitability of existing systems for energy information
- discuss and agree on the format, content and timing of the reports with the users
- focus especially on reports to operations personnel, including on-line monitoring and decision support
- implement reporting, making use of existing monitoring and data infrastructure
- ensure adequate testing and ongoing support for the reporting systems
- continuously revise and refine reports

Defining reporting needs will determine data analysis and monitoring/metering needs. It is an essential early stage task when developing an EMIS and follows the determination of EMIS deliverables (see Section 2.3).



Energy Data Analysis

Overview

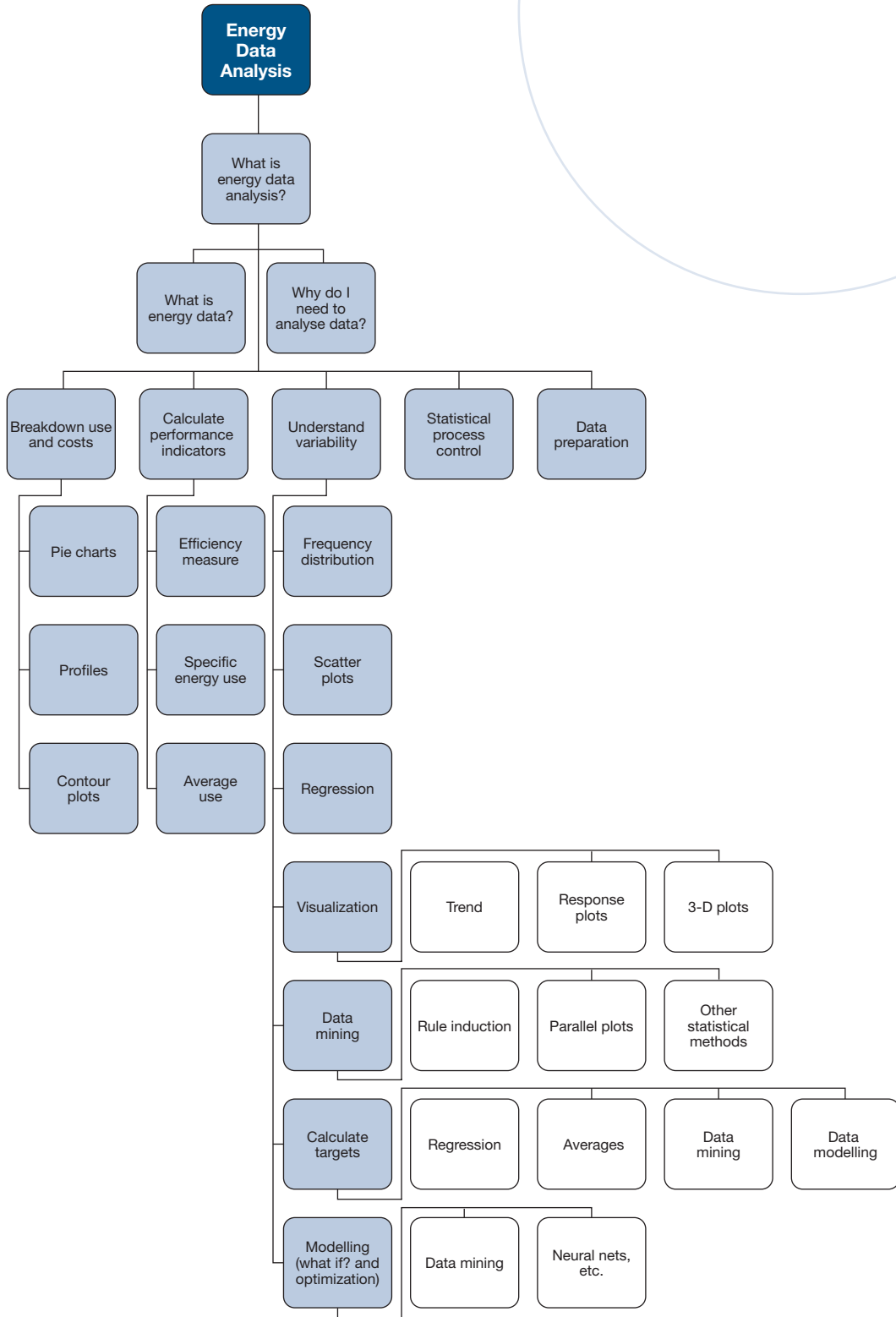
The following discusses the analysis of energy data and is a key section of this handbook. Effective data analysis is essential but is often not given appropriate priority. In fact, poor analysis of data can destroy the operation of an EMIS and result in misleading messages.

Energy data includes not only energy usage but key influencing factors as well. Data must be collected at a higher frequency than any variations that are being studied.

The objectives of data analysis are to better understand energy use and costs, calculate performance levels, calculate targets and model energy use. A range of techniques can be utilized, from simple to complex. These should be selected to suit the problems being addressed (rather than selecting an analysis technology and then finding a problem to suit).

The block diagram shown in Figure 19 summarizes the topics covered in this section.

Figure 19. Block diagram showing elements of energy data analysis

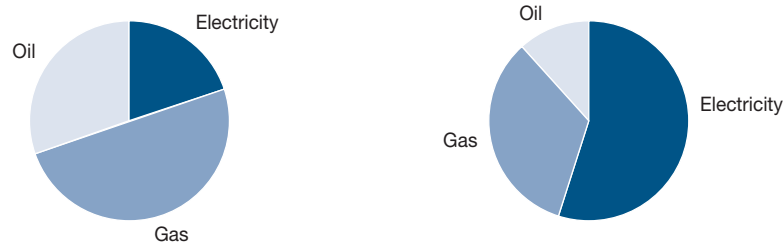


In the examples in Figure 20, utilities (electricity, gas, oil, steam, etc.) have been combined, typically shown on a cost basis.

Charts based on energy use (MJ, kWh, etc.) or CO₂-equivalent emissions may also be useful. It can be instructive to show the various utilities use and costs graphically. All of these graphs are essential in energy management and are typically based on a year's worth of data.

Figure 21 shows utilities broken down by energy and cost (cost is shown at right), showing the relatively high cost of electricity and the impact this has on energy use efficiency priorities.

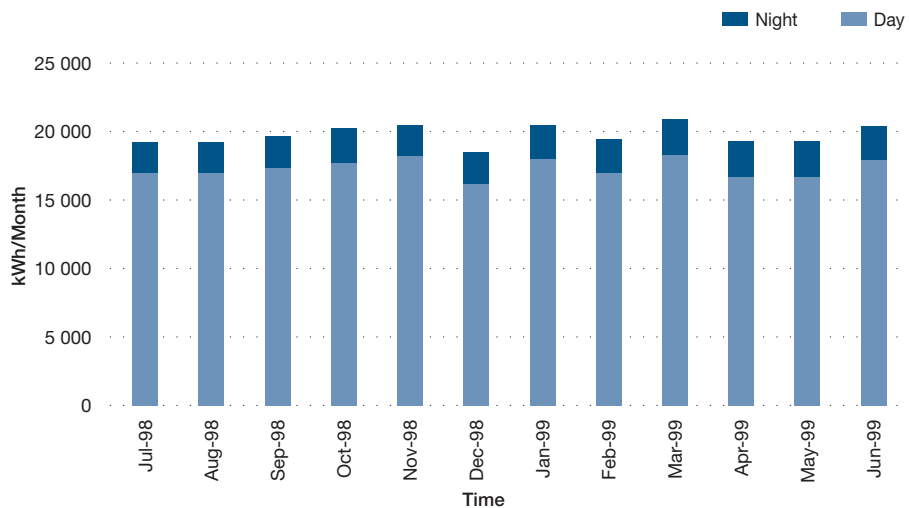
Figure 21. Breakdown of utilities' use and cost



Charts such as these can easily be produced using standard spreadsheet packages or similar software and can be easily published, for example, as part of an energy Web site on the corporate intranet.

In some cases it can be useful to subdivide energy use by time. For example, determining average energy use during non-productive periods (e.g., nighttime, holiday periods) can be highly informative, revealing poor control of plant operations (e.g., poor isolation of compressed air).

Figure 22. Monthly breakdown of electricity use showing day and nighttime units



Determining peak demands can also be informative. Where possible, a demand profile should be studied.

Figure 23a. Typical half-hourly demand profiles (as a line graph)

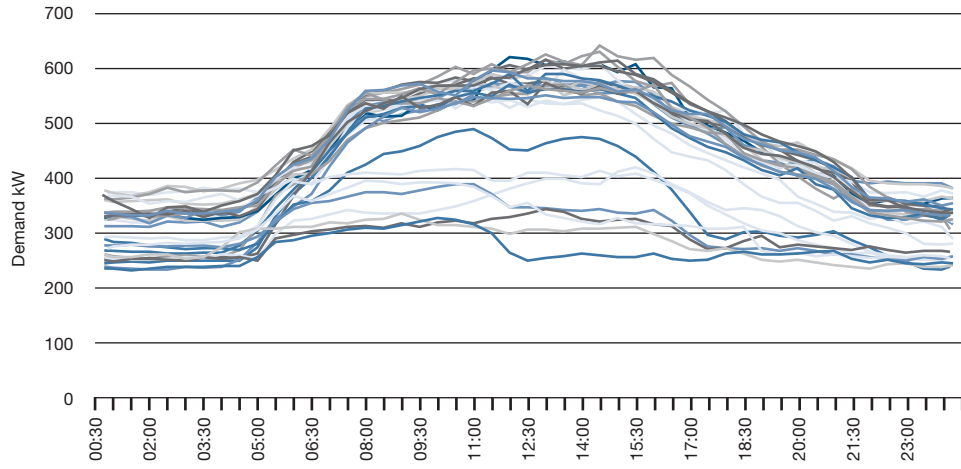
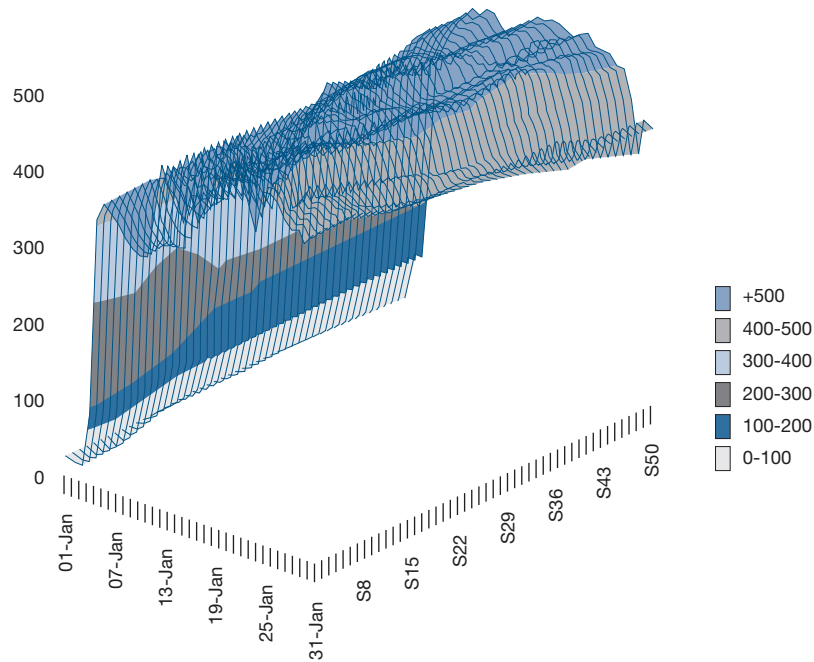


Figure 23b. Typical half-hourly demand profiles (as a contour plot)



8.4 Calculation of Performance Indicators

Energy performance can, in some cases, be a simple measure, such as the energy use of an area or process. However, energy use is often affected significantly by external factors, such as production rate, in which case organizations may use “specific energy use,” i.e., energy use divided by the production level.

These and similar measures should be interpreted very carefully! A process that has a high base-load energy demand, for example, will have a lower specific energy use at higher production rates, even if the underlying efficiency of operations remains unchanged.

Other measures of efficiency can be used, such as the efficiency of a boiler or the coefficient of performance (COP) of a refrigeration system. These values would also be expected to vary (boiler efficiency, for example, with steam loading and COP with ambient temperature).

Performance indicators are useful; however, they should be compared with targets, including

- targets derived from a model of operations
- targets based on the achievement of similar plant/processes under similar conditions (either the same plant/process in the past or another process that is very similar)

8.5 Understanding Performance Variability: Simpler Techniques

There are a number of simpler techniques that can be used to understand variability in energy use. Variability can be displayed as a frequency distribution, which shows the average value, spread (or standard deviation) and the shape of the distribution.

Figure 24. Example of frequency distribution

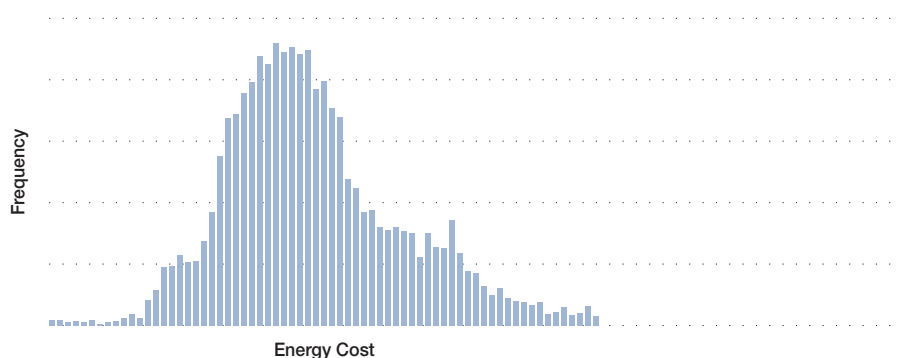
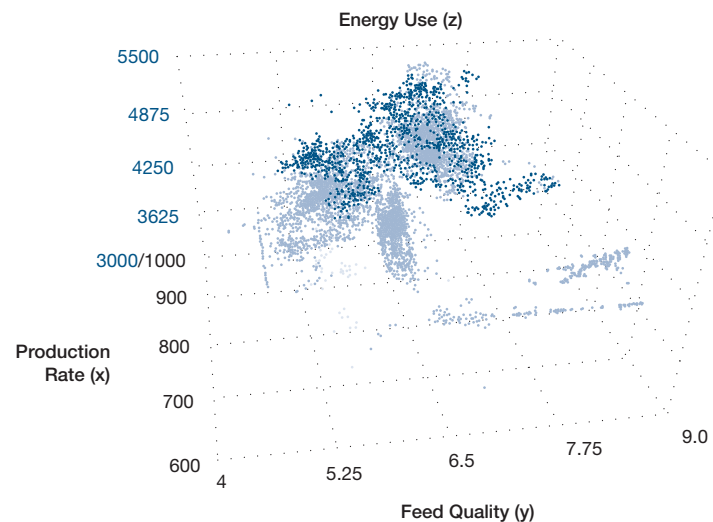


Figure 24 shows a typical example of the specific energy cost of a process operation. There is a significant spread, which an analysis would aim to explain. Is the spread due to external factors or a decision made by operations?



Figure 26. Example of three-dimensional plot, showing energy use vs. production and feed quality



Multiple regression techniques can produce extended equations to describe the relations.

$$y = m_1 x_1 + m_2 x_2 + m_3 x_3 + \dots + c$$

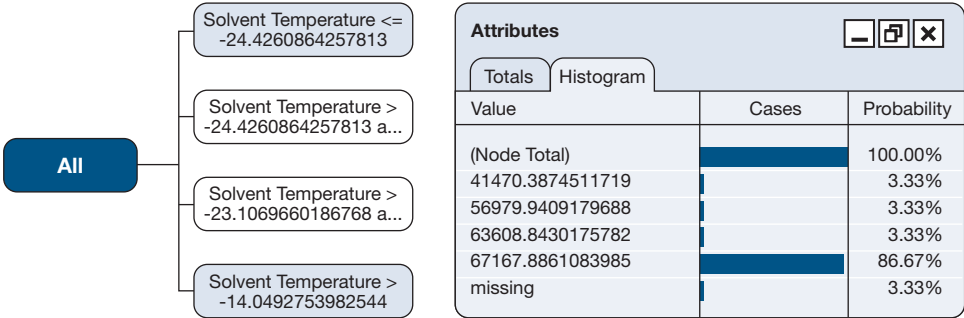
Software tools are readily available to facilitate these graphs and calculations; commonly available spreadsheet programs have most or all of the capabilities needed.

Trying to decipher patterns from numerous single plots of many variables can be very cumbersome. Multiple two-dimensional scatter plots offer a means of finding relationships between multiple variables (matrix plots) by illustrating, at a glance, the patterns that are inherent in the data. In Figure 27, the shaded cells identify the axis labels for each variable that is plotted. The first non-shaded cell in the top row plots production rate on the y-axis vs. energy use on the x-axis. The first cell on the bottom row plots the controllable value "Control 1" on the y-axis vs. "production rate." High-energy-use data is coloured light blue. As an example of the patterns that may be spotted in this multiple two-dimensional scatter plot, the relationships between energy use and feed quality are clear. Another example of high energy use is associated with lower values of the controllable value "Control 2."



Rules are generated automatically in such an analysis. The user defines only the objectives and influencing factors. The process essentially subdivides historical operations into modes; where energy use is different, the modes are characterized by rules.

Figure 28. Simple decision tree



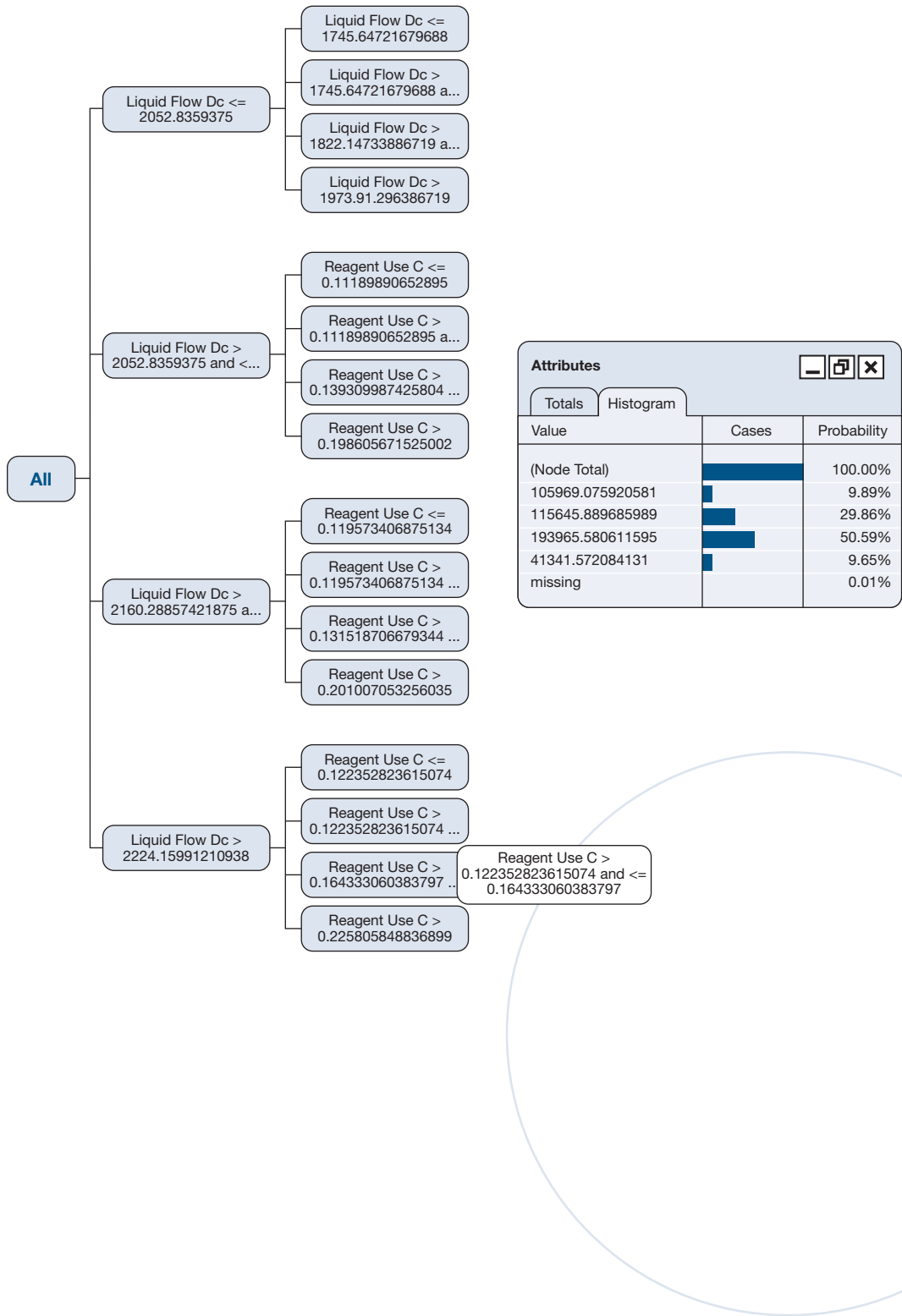
A real analysis will create substantially more complex decision trees (there are more complex rules), such as the one illustrated in Figure 29. Such a tree will

- identify key drivers
- quantify the impact on energy use
- identify the best operating modes

Figure 29 identifies a node path for the liquid flow and reagent use that determines a 50.59 percent probability that energy consumption will be 193 965 units under these conditions.

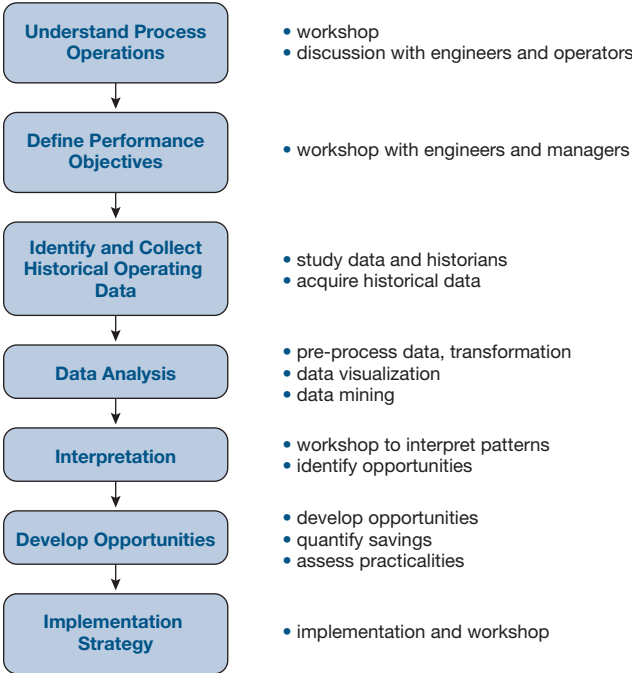


Figure 29. Complex decision tree



Data-mining tools are readily available and widely used. Figure 30 shows the typical stages of such an analysis.

Figure 30. Stages of an initial data-mining analysis



These stages apply to any comprehensive data analysis project.



Example 2: High-Pressure Boiler Plant Performance

An analysis of the efficiency of a high-pressure boiler plant was completed. The plant houses three boilers, two of which are normally in service at any one time. The boilers are capable of dual-fuel firing on natural gas or oil and generate steam at a maximum pressure of 1600 psig (11 Mpa) to supply steam turbines and other loads at reduced pressure.

Data was collected from the plant following modification of the site-monitoring systems and mined, with operating cost per unit of steam being the main focus.

Figure 31. Boiler manifold steam pressure



Attributes included the selection of boilers into the operating sequence, loads, pressures, temperatures and turbine bleed steam flows.

Figure 31 illustrates the boiler manifold steam pressure over a half-hour period.

The impact of manifold header pressure (mpress) on the operating cost is illustrated in the decision tree that is partially illustrated in Figure 32. In this case, a higher steam pressure reduces the operating cost per unit of steam produced. In comparison, Figure 33 illustrates that simply relying on plots of cost vs. manifold steam pressure would not clearly show the influence of manifold steam pressure. This is due to the changes within the data set that are happening for many other factors that affect performance.



Figure 32. Impact of manifold pressure on operating cost – partial decision tree

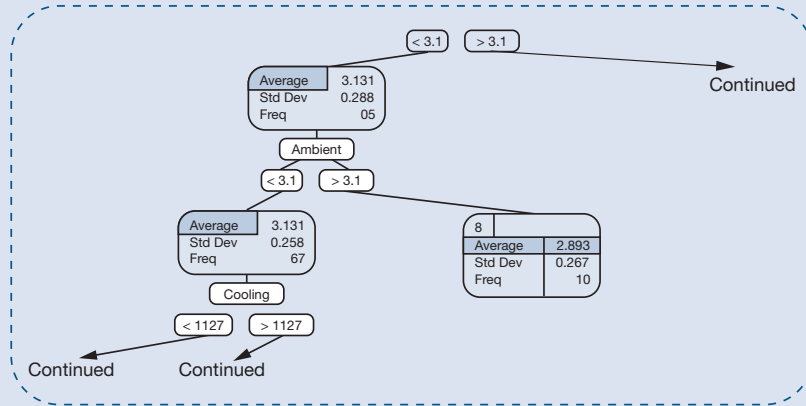
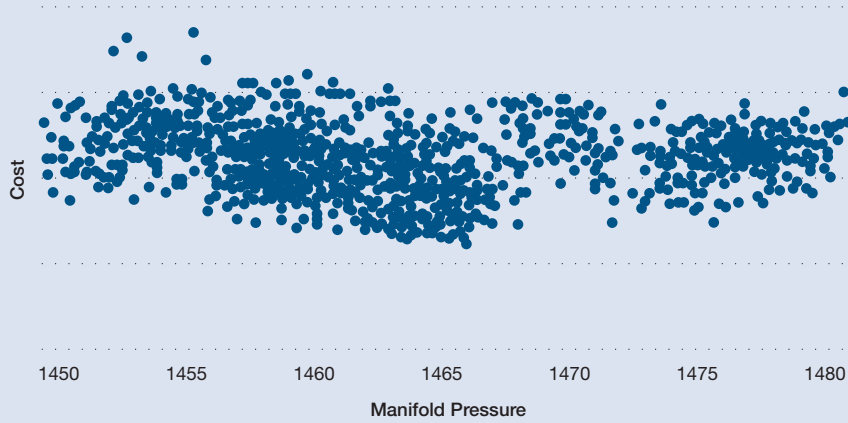


Figure 33. Cost vs. manifold pressure



In total, annual cost avoidances of 4 percent were identified (valued at approximately \$500,000), yielding a simple payback period of approximately one year.



8.7 Calculating Targets

Targets are expected performance values that can be compared with actual performance to discover whether a plant or process is performing well or not. Targets take several forms, including the following:

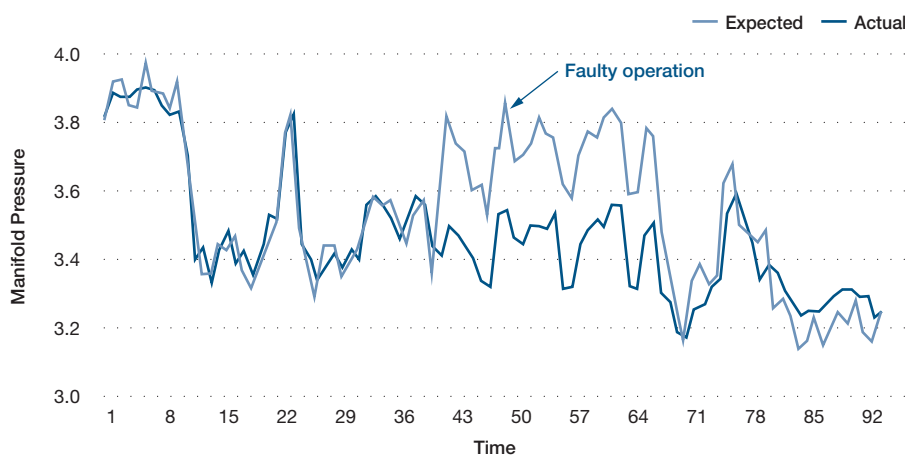
- Historical average performance is a commonly used target. These can be used to alert operations staff when performance is below average.
- The simplest form of such a target is the average energy use during an earlier period, for example, the last year or the last month.
- Often, targets will have some adjustment for external influencing factors, such as production rate or ambient temperature. Typically, this adjustment is based on a regression or multiple-regression analysis.

In some cases, the target is adjusted to reflect a desire to improve. For example, the target may be adjusted to further reduce energy use by 5 percent across the board.

The accuracy and robustness of targets is vitally important. An incorrect target will mislead; improvements may not be reflected in the calculations or poor performance may not be identified. Poor targets result in a loss of confidence in monitoring and ultimately failure to achieve energy savings.

A more sophisticated historical target can be developed using data mining and similar techniques. More data can be analysed, more influencing factors can be accounted for, and non-linear relationships can be handled effectively.

Figure 34. Actual vs. target performance



A target produced from a detailed analysis of data collected (for example, hourly or every 15 minutes) can be sufficiently accurate to implement on-line in real time. The benefits of this include more rapid identification of operating problems. Such an approach should be seriously considered for major energy users.



The historical average performance can be considered a benchmark against which future performance can be compared. It represents what typically would have happened had no changes (improvements) been made.

A best-practice target identifies what a process or plant could achieve if it were operated well. It differs from average historical performance and a desired improvement since it is based on facts about the improvement potential.

Best practice can be calculated from first principles, in which case it represents what theoretically can be achieved. Computer models are applied widely in major processes such as oil refining and petrochemicals and are becoming more common in other sectors. Models of utility systems such as boilers and refrigeration plants are also in use.

Alternatively, best-practice targets can represent the best performance achieved in the past, given the particular (external) conditions. This can be discovered from historical operating data using data mining and similar techniques.

A best-practice target is discovered by identifying periods of operation in the past where external conditions were similar to those currently in place and then selecting the best performing period as the target. Software tools are available to automate this process.

Performance against targets can be represented in a number of ways. Poor performance as compared with the target can be reported as it becomes known and expressed, for example, in terms of the annual cost if the faults are not fixed.

Figure 35a. Performance reporting

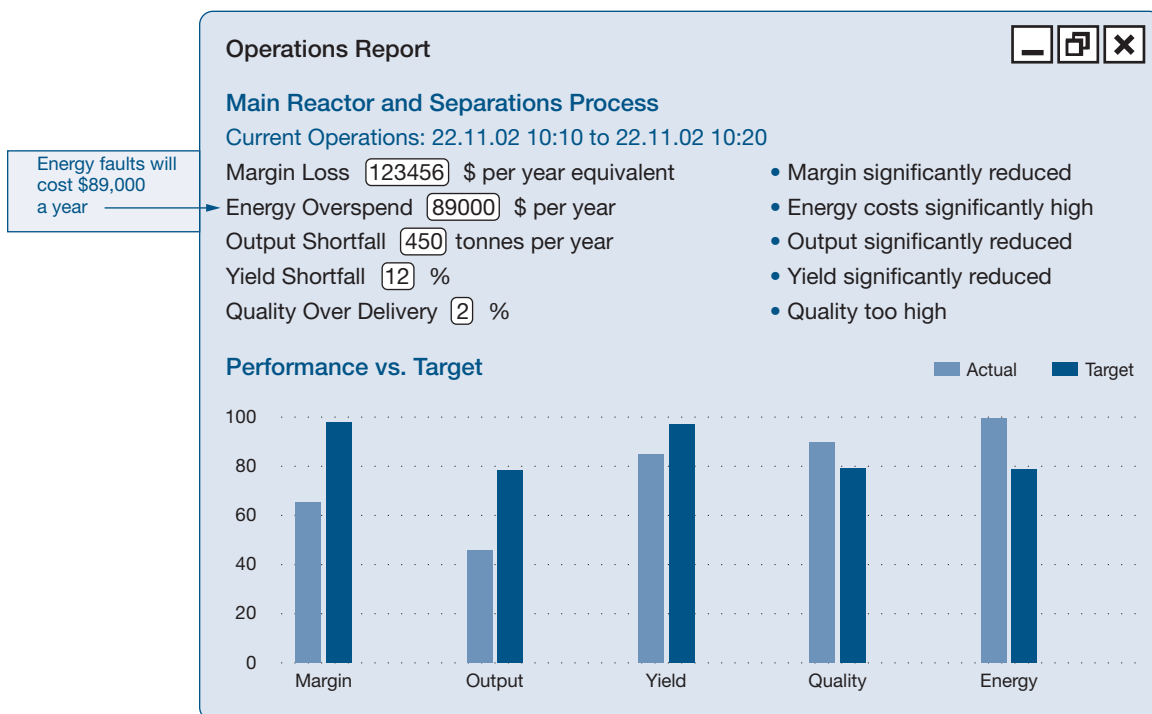


Figure 35b. CUSUM reporting (as a line graph)

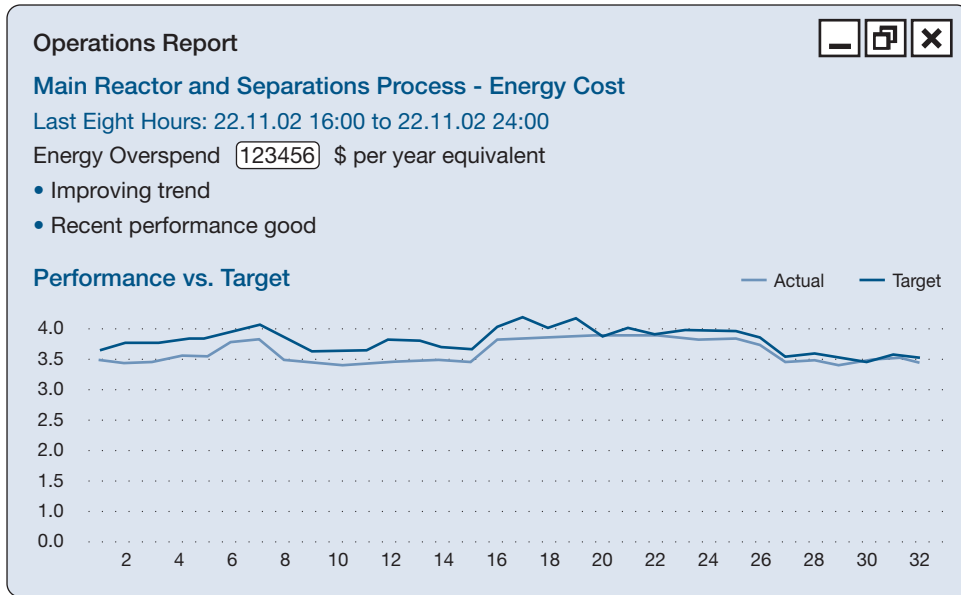
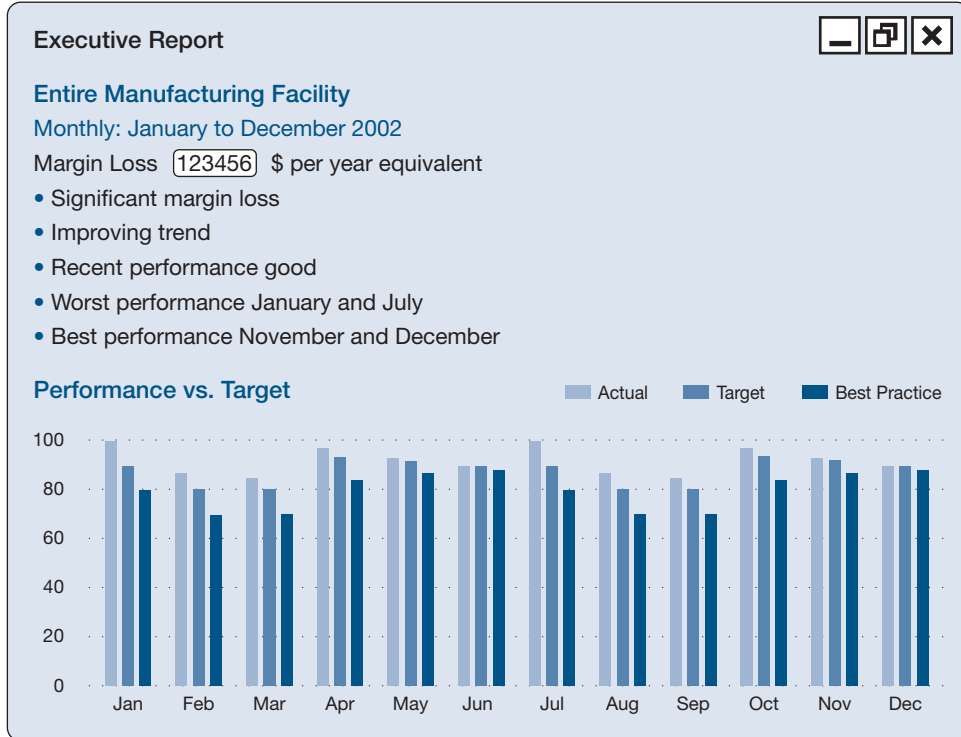
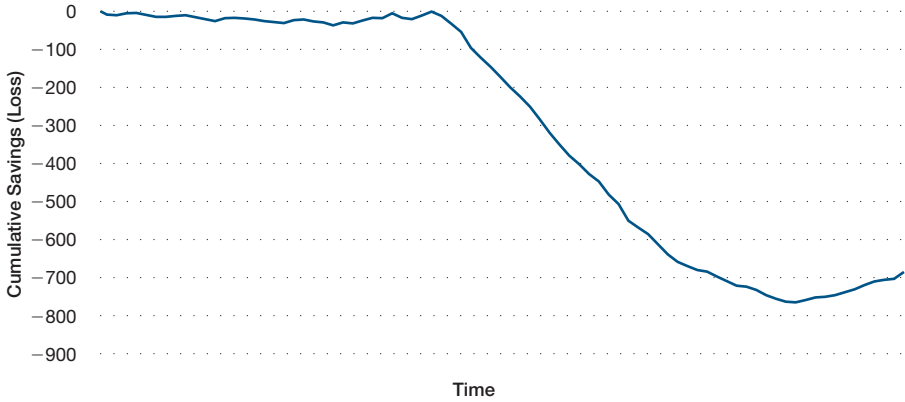


Figure 35c. CUSUM reporting (as monthly, weekly or yearly summaries)



Cumulative sum (CUSUM) techniques show the cumulative savings made over a period. Figure 36, for example, shows cumulative savings over a period of eight weeks.

Figure 36. CUSUM reporting



CUSUM figures are calculated by adding the savings of each period to produce a running total. If the process is on target, the savings will on average be zero, and the CUSUM line will be horizontal. Off-target performance will “lose” each period, and the slope of the CUSUM line will be negative. Above-target performance will produce a positive slope. A change of gradient on a CUSUM graph signifies an “event” – a change in the performance of the process.

8.8 Data Modelling and “What If” Analysis

Targets are calculated by producing a model of operations using historical operating data (or a first-principles model).

Other modelling techniques can be considered, including neural networks, case-based reasoning and other statistical and mathematical techniques. These techniques should be applied carefully – modelling process operations requires a good understanding of the relationships between variables on the part of the analyst. Rule induction facilitates that understanding.

In spite of the pitfalls, data modelling can be an effective basis for monitoring control and optimization solutions, and the models can be used to study the impact of altered conditions – a “what if” analysis.



Metering and Measurement

Overview

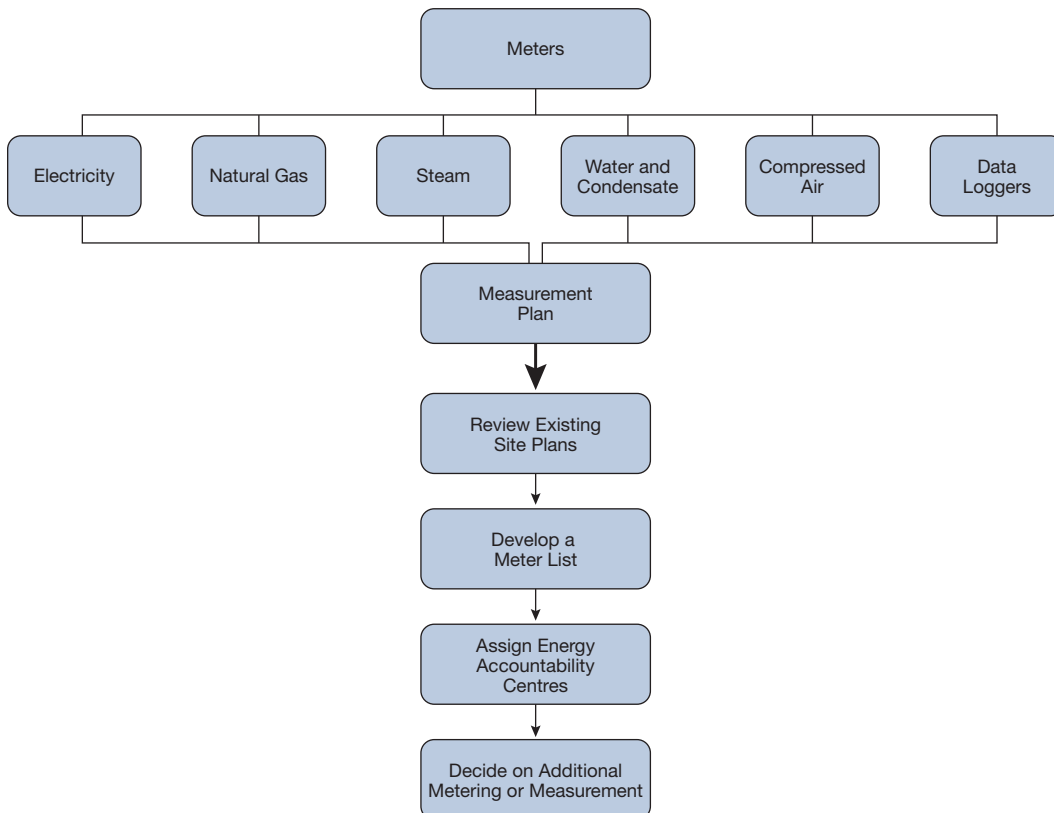
This section discusses the characteristics of available metering and the required infrastructure to collect and store data.

Outlined in the following is an approach to guide the end-user toward implementing a metering and measurement system, bearing in mind the following key questions:

- Do I need any additional meters to manage energy use?
- How do I decide where to install meters?
- What meters should I use?
- How do I link these meters to my monitoring systems?
- Can I afford them? If not, what are the priorities?
- What are the practical and other issues I need to know about?

A structured approach to developing a measurement plan is illustrated in Figure 37.

Figure 37. Measurement plan – A structured approach



9.3.1 Step 1: Review Existing Site Plans

If up-to-date site plans are available, single-line diagrams should illustrate natural gas and electrical distribution to major loads. The electrical schematics will illustrate the power distribution to transformers, motor control centres and major loads. The schematics, having revealed the configuration of the energy distribution and metering, will provide valuable insight as to whether the existing distribution systems readily lend themselves to metering for cost allocation purposes.

A structured approach to a measurement plan

In many instances, many of the main gas metering points or motor control centres could supply loads in different plant or facility cost centres. Installing additional metering for all these loads would likely be cost-prohibitive or at odds with the site's budgetary constraints. The steps listed in the following will help rationalize the decision as to the number and location of meters that will strike a balance between the site's objectives and budgetary constraints.

9.3.2 Step 2: Develop a Meter List

A list of meters that will be included in the overall cost allocation strategy should be developed. A simple example of such a metering list is illustrated in Table 7.

Table 7. Metering list

Metering Point	Metered Load
CA 1	No. 1, No. 2 air compressors
E 1	115 kV sub
E 2	Administration building
W 1	Municipal water service
NG 1	Main site entrance
NG 2	Dryers
E 3	Parking lot car block heaters and lighting
W 2	No. 1, No. 2, No. 3 service water pumps
S 1	Utility boilers No. 1, No. 2
E 4	HVAC units No. 1, No. 2, No. 3

9.3.3 Step 3: Assign Energy Accountability Centres

After completing the metering list, energy accountability centres can be assigned in accordance with the plant or facility's business units. Table 8 illustrates an example as to how the energy accountability centres may be configured in accordance with the metering list presented in Table 7.



Table 8. Energy accountability centres

Business Unit	Energy Accountability Centre	Performance Variable	Metered Load
Site services	Administration	Tonne of product	E 2
Site services	Parking lot	Tonne of product	E 3
Site services	Building heating	Outdoor air temperature	NG 1 – NG 2
Site services	Air conditioning	Outdoor air temperature	E 4 – Calculated Factor
Site services	Domestic water	Tonne of product	W 1
Process	Materials handling and production	Tonne of product	E 1 – (E 2 + E 3 + E 4)
Process	Process heating	Tonne of product	NG 2
Process	Compressed air	Tonne of product	CA 1
Process	Process water	Tonne of product	W 2
Process	Process steam	Tonne of product	S 1

9.3.4 Step 4: Decide on Additional Metering or Measurement

Adopting a systematic approach to tabulate a metering list and energy accountability centres reveals areas where metering and measurement can be improved.

For example, major process loads such as pumps, motor drives, etc. could be electrically sub-metered to gain more knowledge on usage rather than having to rely on a coarse measurement from meter subtraction for process, as illustrated in Tables 7 and 8.

Also, there is a gap in potential useful information to be gained from the compressed-air system, which is not power metered according to the metering list. At the moment, compressed-air flow (m³/sec) can be “ratioed” against total production (tonne of product). Electrically sub-metering the bank of air compressors (No. 1 and No. 2) would enable the performance of the air compressor equipment to be tracked – (m³/sec)/kW – yielding valuable diagnostic information. If Metering Point E 5 were added in this regard, the energy accountability centre tabulation would be amended with the following addition:

Business Unit	Energy Accountability Centre	Performance Variable	Metered Load
Process	Compressed air	Total airflow	E 5



9.4 Deciding on What Types of Metering to Use and Practical Considerations

9.4.1 Electrical Metering

In many cases, power quality and feed protection issues represent the driving force for sub-metering electrical power instead of energy management considerations. In moving to an energy management and cost control justification for installing additional metering capability, the following should be considered when reviewing the types of commercially available metering equipment and subsequent selection.

As a start, existing utility revenue metering should be utilized to the fullest possible extent, particularly to gain an appreciation of a site's total electrical load profile or for billing verification. Special concerns related to using existing revenue metering include the following:

- Because the revenue meter is the property of the utility and is a regulated device, utility personnel should make any modifications.
- Modifications typically include retrofit with a pulse initiator or installation of a pulse splitter on an existing pulse initiator.
- It is key that the pulse value is obtained from the meter or the utility.
- When existing facility panel meters cannot be refitted with pulse initiators or when voltage levels prohibit cost-effective installation of new meters, new 5-amp current transformers could be installed on the secondary side of existing meter current transformers, which would in turn be connected to new metering equipment. This metering approach is not as accurate as direct metering because measurements based on secondary current introduce a second measurement error.

Tying into existing power utility revenue metering

Power meters owned by the site for monitoring total power to a major load centre would typically be located at the point of delivery (sub-station) and monitor the watts and Q-pulse from the utility revenue meters. Total kVA, kW and kVAR readings would then be calculated from these signals. A typical digital power meter for this application would offer a digital readout display and a maximum sampling rate of 128 Hz. A standard version may allow for a maximum of four channels. In comparison, a premium, more advanced version of this power meter would include most of the same features but have a video display terminal and allow for a maximum of 42 channels. The premium version is generally more suited to revenue grade metering and would offer power quality analysis, event-triggered data storage and logging.

An economical power measurement unit for sub-metering could typically offer a digital readout display and a maximum sampling rate of 32 Hz. Typical power measurement would include apparent power (VA), reactive power (VAR) and power factor (PF), as in the more premium models previously referred to. This unit would typically be ideal for use as a power transducer for DCS, EMS, SCADA and PLC systems.



A deregulated power market application may impose certain metering requirements. The following Web sites are included for reference, representing power-metering products that are deemed to conform to the requirements of some open markets:

- Conforming list for an Independent Electricity Market Operator in Ontario:
www.iemo.com/imoweb/metering/meterlist.asp
- IEMO Wholesale Revenue Metering Standard:
www.iemo.com/imoweb/pubs/metering/mtr_wrmStdHw.pdf

End-users are encouraged to research the particular requirements that apply to the region in which their plant or facility is located.

9.4.2 Natural Gas Metering

In most cases, natural gas sub-meters with dial indicators are used. Although equipped with pulse output capability, this feature is rarely used, largely due to perceived cost considerations. Larger areas of natural gas consumption may have meters that make use of the utility's pulse signal.

Natural gas meters range in size and capacity from 2-in. (50-mm) flanged connections at 800 CFH (22.6 m³/hr.) capacity to 56 000 CFH (1600 m³/hr.) rating. For small commercial loads of up to 15 psig (1 bar), compact line-mounted meters with a dial-face or odometer-type index can be purchased. For higher-volume industrial loads, a full range of meters that are rated for working pressures of up to 300 psig (24 bar) are available.

Many site-owned meters remain uncorrected for temperature and pressure, bringing the accuracy of many site-metered volumes into question. Compensation for temperature effects can be accomplished by a mechanical computer with a spiral bi-metallic thermocouple probe, positioned at the meter inlet within a sealed temperature well. Natural gas volume readings may be corrected to a 60°F (15°C) basis to yield readouts in standard cubic feet (SCF) or normal cubic metres (Nm³) between flowing temperatures of –20°F to 120°F (–29°C to 49°C).

Ensure that pressure/temperature compensation is applied to natural gas meters.

Pressure correction factors may be calculated according to the following formula:

$$\frac{\text{Utility delivery pressure} + \text{Site atmospheric pressure}}{\text{Atmospheric pressure at sea level}}$$

For example, if the utility delivery pressure is 50 psig (345 kPa), estimated site atmospheric pressure is 14.6 psi (100.66 kPa) and atmospheric pressure at sea level is 14.73 psi (101.56 kPa), then the pressure correction factor would be

$$\frac{50 + 14.6}{14.73} = 4.39$$

As such, the metered volume would be multiplied by 4.39 to obtain a “true” reading in this case.



Temperature- and pressure-compensated meters are commercially available from major vendors. Some meters are available with battery-powered microprocessor-based correction for temperature and pressure effects. The corrector may be integrally mounted within the body of the meter or externally mounted on a wall, pipework or standard instrument drive.

Thermal-dispersion-type flow meters offer relative simplicity of measurement through a single-pipe penetration, thus eliminating temperature and pressure transmitters and density compensation calculations required by differential pressure, vortex and turbine type metering. As such, less hardware is needed for a metering system, and this flow meter offers an alternative and accurate means of gas-flow measurement. Communication between the flow meter and signal processor assembly is over two-wire pair. Linear output signals of 0-5 V DC or 4-20 mA can interface with either RS 232 or RS 485 communication.

It must be remembered that because gas service entrances and meters are usually located outdoors, a \$1,000 metering point can incur a final cost of \$10,000 when the costs of trenching, buried conduit and structural penetrations through buildings for pipework are considered. In these cases, wireless data communications may present a viable alternative.

Much like electrical meters, a pulse initiator could be installed on existing natural gas meters by the utility to provide shared signals. For cases where a pulse initiator is already present on the meter, a pulse splitter may be installed. Important points to consider in using shared signals for natural gas metering include

- allocate enough coordination time with the utility
- obtain from the utility the correct scale factor for the meter
- temperature and pressure compensation of the output from the pulse initiator

It should be emphasized that although sharing signals with utility meters can be cost-effective, sharing signals with existing facility meters can entail unforeseen calibration and repair expenses. Related concerns include

- all the inaccuracies of the existing metering system are assumed
- existing facility meters could potentially be improperly sized
- calibration documentation could be limited or unavailable
- impracticality of removing meters from a live system could leave no alternative but field calibration, with its associated approximations

9.4.3 Steam Metering

Orifice plate meters are in common use throughout plants. Calibration data would have to be obtained either from the facility's calibration records or from a meter's nameplate data. Steam flow is proportional to the square root of the pressure difference across the measuring orifice plate. At low flows, significant changes in flow may not generate significant changes in differential pressure, leading to measurement error. This is a concern if steam generation falls below the turndown ratio for rated accuracy of the orifice plate measuring device, leading to inaccurate data logging.



Another caution regarding the use of orifice plate steam flow meters relates to when steam pressure is lowered. Steam flow readings extracted by differential pressure orifice plate devices are usually affected when steam pressure is lowered due to a corresponding reduction in steam density. This in turn results in a greater pressure drop at the orifice plate for a given flow, yielding a proportionally higher steam flow reading. Calculated mass flow correction factors must be applied to steam flow readings in this case to obtain a true reading. Discussions with site personnel reveal that automatic pressure compensation is rarely applied.

An example of mass flow correction as applied to orifice plates for saturated steam is outlined as follows:

Given a flow reading of 13 607 kg/hr. of saturated steam, an operating pressure of 690 kPa and an orifice plate design pressure of 862 kPa, what is the actual corrected mass flow?

The correction formula is: $C_m = \sqrt{(dD/dA)} \times (dA/dD)$

Where dA = steam density at actual pressure

dD = steam density at design pressure

C_m = mass flow correction factor

From steam tables: $dD = (1/\text{specific volume}) = 1/0.201 = 4.976 \text{ kg/m}^3$

$dA = (1/\text{specific volume}) = 1/0.243 = 4.120 \text{ kg/m}^3$

$C_m = \sqrt{(4.976/4.120)} \times (4.120/4.976) = 0.9098$

Therefore, the actual steam flow is $0.9098 \times 13\ 607 = 12\ 380 \text{ kg/hr.}$

Differential pressure is usually measured by a differential pressure transmitter and conditioned into a 4-20 mA or other industry standard signal to an energy management and control system.

Vortex flow meters, although more costly, offer greater accuracy compared with orifice plate flow meters and have over three times the “rangeability.” Another alternative to flow measurement by orifice plate is offered by annubars, which consist of diamond-shaped sensors that are inserted in the flow stream. Annubar flow sensors generate lower permanent pressure loss due to reduced flow restriction and require less labour to install. As an example, an annubar installed on an 8-inch (200-mm) pipe requires only 4 linear inches (20 cm) of welding compared with an orifice plate, which requires 50 inches (125 cm) of welding for the same pipe. Installed cost savings range from 25 percent on smaller pipes to 70 percent on larger pipes. As in the case for orifice plates, manufacturer’s data must be consulted to determine the appropriate temperature and pressure compensation factors. Rangeability will be similar to orifice plates.

Beware of calibration for orifice plate steam metering.



9.4.4 Water and Condensate Metering

Unless a meter is very old, existing turbine, rotating disc, vortex and magnetic flow meters can usually be retrofitted with a pulse head. Final confirmation of this should be made with the meter manufacturer. Although rarely calibrated, most of these flow meters probably have reasonable accuracy if the meters are in serviceable condition. Be aware that the costs of meter removal, replacement of worn parts and recalibration could often equal the cost of a new meter. It is suggested that any pulse-head retrofit should be accompanied by the installation of a local register to provide a check reading.

Pulse head retrofit is usually required for water meters.

If the metering pipework includes a check valve to stop the flow of condensate or water through the meter, and if the check valve fails, the flow may be correctly metered on the local register but metered multiple times by the pulse head.

Numerous types of venturi, annubar and orifice plate meters that use differential pressure transmitters will be encountered in the field. These are susceptible to numerous operational and calibration issues.

Non-intrusive type flow meters offer a means of performing spot checks for liquid flow measurement. These include magnetic, transit time and doppler-type sonic flow meters. The main advantage of this metering equipment is that it offers portability of measurement and unobstructed flow with no pressure drop in the pipework. Important points to consider in selecting non-intrusive meters include

- magnetic flow meters are relatively expensive but offer high rangeability (30:1) and are suitable for dirty fluids and bi-directional flow measurement
- transit-time-based sonic flow meters offer high accuracy for relatively clean flows but are adversely affected by bubbles or particles in the flow stream and internal deposition on pipe walls, and require full pipe flow with moderate turbulence
- the accuracy of doppler-type sonic flow meters depends on the presence of suspended particles or bubbles in the liquid flow stream

9.4.5 Compressed-Air Metering

Although widely used, orifice plates are inappropriate for compressed-air systems because they offer limited turndown capability (3:1), and they generate relatively high differential pressures. It is suggested that Pitot-tube-based instruments offer improved turndown and relatively negligible differential pressure. Selection of a Pitot-tube-based measurement should include temperature and pressure compensation in order to produce true flow readings. Both the Pitot tube and Type J thermocouple should be installed in an undisturbed section of the compressed-air line from each compressor.



Lack of pressure gauges or uncalibrated gauges in the system restrict measurement of differential pressures on critical components such as filters, coolers and separators. Installation of test taps at selected locations would enable the use of one calibrated precision instrument to obtain reliable pressure readings and avoid maintaining and calibrating a number of gauges.

9.4.6 Data Loggers

In situations where access is cumbersome (e.g., motor and fan housings, electrical junction boxes, air vents, etc.), data related to temperature, relative humidity, voltage, amperage, pressure and CO₂ can be monitored by data loggers. Since they are stand-alone devices, they can also be re-used for other assignments. Relative cost is low compared with more permanent data-acquisition systems.

The role of data loggers

Most data loggers can interface with a PC. Some have external input capabilities that may be wired to existing gauges and sensors that are equipped with voltage output terminals, also enabling these devices to be monitored and recorded.

Data loggers offer an alternative measurement application for opportunities where a small number of simple retrofit measures (e.g., lighting) are replicated in great quantity and only a representative sample requires metering. Knowing the operational profile of a motor or lighting system that has a flat amperage-draw profile enables energy consumption to be readily computed.

9.5 Linking Meters to Monitoring Systems

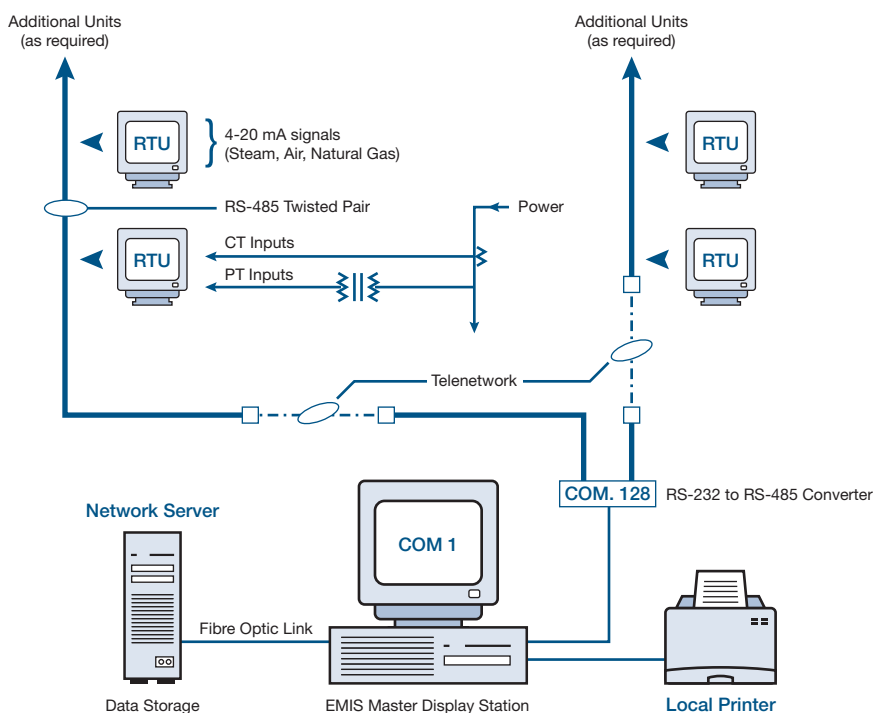
Following the selection of metering equipment, the architecture of the system that links the data collected in real time from various remote electronic meters (natural gas, power, compressed air, steam and water) to the EMIS software must be configured.

Currently, most meters have analogue output options (4-20 mA), serial digital interface options (direct RS 232) and network bus communication interface capability, for example, Ethernet, Modbus remote terminal unit (RTU), etc. As such, although most meters can be initially used on a stand-alone basis, these can be integrated within a complete plant or facility-wide system for monitoring and control through a common communication link, offered through open architecture.

Figure 38 illustrates a commonly used system that utilizes RTUs mounted in the field to monitor energy use in various areas of a plant or facility. The RTUs are interconnected via a local area network (LAN) to a main EMIS computer.



Figure 38. Common EMIS configuration



9.6 Cost Considerations

Cost is always a prime consideration, and having planned for measuring and data acquisition, a decision must be made as to whether the existing metering infrastructure should be used or whether new metering equipment should be purchased. It should be cautioned that the avoided cost of using an existing meter can be offset by the costs of converting to meet new metering requirements, in addition to inspection, repair and calibration costs. Other considerations include technical requirements of the project, whether the meter still has to fulfil its original duty and whether a permanent installation is required.

The cost-effectiveness of metering depends highly on the economies of scale of the end-use. For example, metering of a 200-hp motor is comparable to a 20-hp motor, but the 200-hp motor has the potential for yielding 10 times the savings for similar cost.

Costing is difficult to estimate for the purposes of this handbook in the absence of detailed engineering and the susceptibility of costs to market conditions.



Do You Have an Effective EMIS? A Checklist

The following can help assess an EMIS and compare it with the structured approach presented in this handbook. This checklist may indicate that many of the elements of an EMIS as presented are there, but are under-utilized or not utilized at all. Several desirable elements may be able to be implemented at minimal cost. At the very least, this checklist will indicate what is missing vs. what is achievable and can lead to greater profitability through improved energy use efficiency.

An effective EMIS should include the items listed in the following checklist. Implementing these items should reduce annual energy costs by at least 5 percent.

Features: Does the EMIS Include the Following Key Features?

Yes	No		
<input type="radio"/>	<input type="radio"/>	Effective storage of energy and related data	A modern database, historian and warehouse.
<input type="radio"/>	<input type="radio"/>	Ready access to relevant data by all relevant staff:	Data easily accessed by relevant staff using standard tools (spreadsheet, executive information system, enterprise resource planning, management information system, applications programs, DCS, SCADA, etc.).
<input type="radio"/>	<input type="radio"/>	• Executives	
<input type="radio"/>	<input type="radio"/>	• Senior managers	
<input type="radio"/>	<input type="radio"/>	• Operations management	
<input type="radio"/>	<input type="radio"/>	• Engineering	
<input type="radio"/>	<input type="radio"/>	• Operations personnel	
<input type="radio"/>	<input type="radio"/>	• Planning and scheduling	
<input type="radio"/>	<input type="radio"/>	• Accounts	
<input type="radio"/>	<input type="radio"/>	• External bodies	
<input type="radio"/>	<input type="radio"/>	• Other relevant staff	
<input type="radio"/>	<input type="radio"/>	Calculation of effective targets from historical data or plant simulation	Incorporates modern data analysis tools to create effective targets that take account of multiple influencing factors (beyond multiple, linear regression) and/or includes first principles models of plant operations as targets.
<input type="radio"/>	<input type="radio"/>	Comparison of actual performance against targets	Compares the actual values of energy use and key performance indicators and influencing factors against target values.
<input type="radio"/>	<input type="radio"/>	Historical data analysis	Tools to identify patterns in historical data, ranging from simple graphics to visualization and data mining.
<input type="radio"/>	<input type="radio"/>	Graphical reporting	Reports include simple but effective graphics (line, scatter, bar, CUSUM, three-dimensional, etc.).
<input type="radio"/>	<input type="radio"/>	Data validation	Heat and mass balances, range checks, etc.

Elements

Yes	No		
<input type="radio"/>	<input type="radio"/>	Energy meters	Energy meters in sub-areas of the site automatically read.
<input type="radio"/>	<input type="radio"/>	Measurement of influencing factors	Measurement of influencing factors automatically read.
<input type="radio"/>	<input type="radio"/>	Measurement of key performance indicators	Measurement of KPIs automatically read.



Elements (continued)

<input type="radio"/>	<input type="radio"/>	Automated data acquisition	Automated data collection is a key requirement of an effective EMIS.
<input type="radio"/>	<input type="radio"/>	Data historian	A database that can store and effectively serve.
<input type="radio"/>	<input type="radio"/>	Data analysis tools	A suite of data analysis tools from regression to data mining.
<input type="radio"/>	<input type="radio"/>	Reporting tools	Ideally, tools are already used to report process and business performance.
<input type="radio"/>	<input type="radio"/>	Decision support tools	Software tools or paper-based.
<input type="radio"/>	<input type="radio"/>	Interfaces	To enterprise resource planning, management information system, DCS, SCADA, spreadsheet, etc.

Support

Yes	No		
<input type="radio"/>	<input type="radio"/>	Energy management program	A comprehensive energy management program of which the EMIS is one element.
<input type="radio"/>	<input type="radio"/>	Management commitment	Support and commitment for the energy management program from the CEO and senior management.
<input type="radio"/>	<input type="radio"/>	Allocated responsibilities	Responsibility for energy performance allocated to relevant production, operations and department management, not the energy manager.
<input type="radio"/>	<input type="radio"/>	Procedures	Procedures to ensure the tasks necessary to operate the EMIS and to achieve savings are understood and adopted.
<input type="radio"/>	<input type="radio"/>	Training and support	Technical training, training in using software, support to EMIS users.
<input type="radio"/>	<input type="radio"/>	Resources	Financial commitment and personnel appropriate to the achievable benefits.
<input type="radio"/>	<input type="radio"/>	Regular audits	To check system performance, adherence to procedures and benefits realized.



Appendix A: Abbreviations

CFH	Cubic feet per hour
CIPEC	Canadian Industry Program for Energy Conservation
CO ₂	Carbon dioxide
DCS	Distributed control system
EIS	Executive information system
EMIS	Energy management information system
EMP	Energy management program
ERP	Enterprise resource planning
HVAC	Heating, ventilating and air conditioning
ISO	International Organization for Standards
IT	Information technology
KPI	Key performance indicator
M&T	Monitoring and targeting
MCF	Thousand cubic feet
MIS	Management information system
Nm ³	Normal cubic metres
PLC	Programmable logic controller
psig	Pounds per square inch gage pressure
SCADA	Supervisory control and data acquisition
SCF	Standard cubic feet



Appendix B: Figures and Tables

Figure 1.	Basics of an EMIS	6
Figure 2.	Elements of an energy management program (EMP)	8
Figure 3.	Operations report showing poor performance	10
Figure 4.	Operations report showing improving performance	11
Figure 5.	Report with instructions on how to achieve optimum operating conditions	15
Figure 6.	Learning from data	15
Figure 7.	Example of management report, showing weekly progress	16
Figure 8.	Example of executive report, showing monthly progress	16
Figure 9.	Example of frequency distribution	17
Figure 10.	The EMIS should quantify energy use and costs	18
Figure 11.	Graph showing cumulative savings achieved since an EMIS was installed	19
Figure 12.	Elements of a typical EMIS	21
Figure 13.	Steps toward achieving success	23
Figure 14.	A profile showing blips in energy use	30
Figure 15.	EMIS impact on organizational structure	31
Figure 16.	Decision loop accountabilities and reviews	41
Figure 17.	Effective energy reporting: Questions and answers	46
Figure 18a.	Example of an operations report alert	50
Figure 18b.	Another example of an operations report alert	50
Figure 19.	Block diagram showing elements of energy data analysis	54
Figure 20.	Breakdown of energy use	56
Figure 21.	Breakdown of utilities' use and cost	57
Figure 22.	Monthly breakdown of electricity use showing day and nighttime units	57
Figure 23a.	Typical half-hourly demand profiles (as a line graph)	58
Figure 23b.	Typical half-hourly demand profiles (as a contour plot)	58
Figure 24.	Example of frequency distribution	59
Figure 25.	Energy use vs. production	60
Figure 26.	Example of three-dimensional plot, showing energy use vs. production and feed quality	61
Figure 27.	Multiple scatter plot	62



Figure 28.	Simple decision tree	63
Figure 29.	Complex decision tree	64
Figure 30.	Stages of an initial data-mining analysis	65
Figure 31.	Boiler manifold steam pressure	66
Figure 32.	Impact of manifold pressure on operating cost – partial decision tree	67
Figure 33.	Cost vs. manifold pressure	67
Figure 34.	Actual vs. target performance	68
Figure 35a.	Performance reporting	69
Figure 35b.	CUSUM reporting (as a line graph)	70
Figure 35c.	CUSUM reporting (as monthly, weekly or yearly summaries)	70
Figure 36.	CUSUM reporting	71
Figure 37.	Measurement plan – A structured approach	73
Figure 38.	Common EMIS configuration	84
Table 1.	Examples of typical problems that cause higher energy costs	12
Table 2.	Success matrix	27
Table 3.	Evaluating a corporate energy management program	28
Table 4.	Approximate justifiable EMIS capital cost	40
Table 5.	Examples of areas that require utility metering	55
Table 6.	Examples of influencing factors	56
Table 7.	Metering list	76
Table 8.	Energy accountability centres	77



Canadian
Industry
Program for
Energy
Conservation



CIPEC

For more information or to receive additional copies
of this publication, write to

Canadian Industry Program for Energy Conservation
Office of Energy Efficiency
c/o Natural Resources Canada
580 Booth Street, 18th Floor
Ottawa ON K1A 0E4
Tel.: (613) 995-6839
Fax: (613) 992-3161
TTY: (613) 996-4397 (teletype for the hearing impaired)
E-mail: cipec.peeic@nrcan.gc.ca

Leading Canadians to Energy Efficiency at Home, at Work and on the Road

The Office of Energy Efficiency of Natural Resources Canada
strengthens and expands Canada's commitment to energy efficiency
in order to help address the challenges of climate change.

Canada