

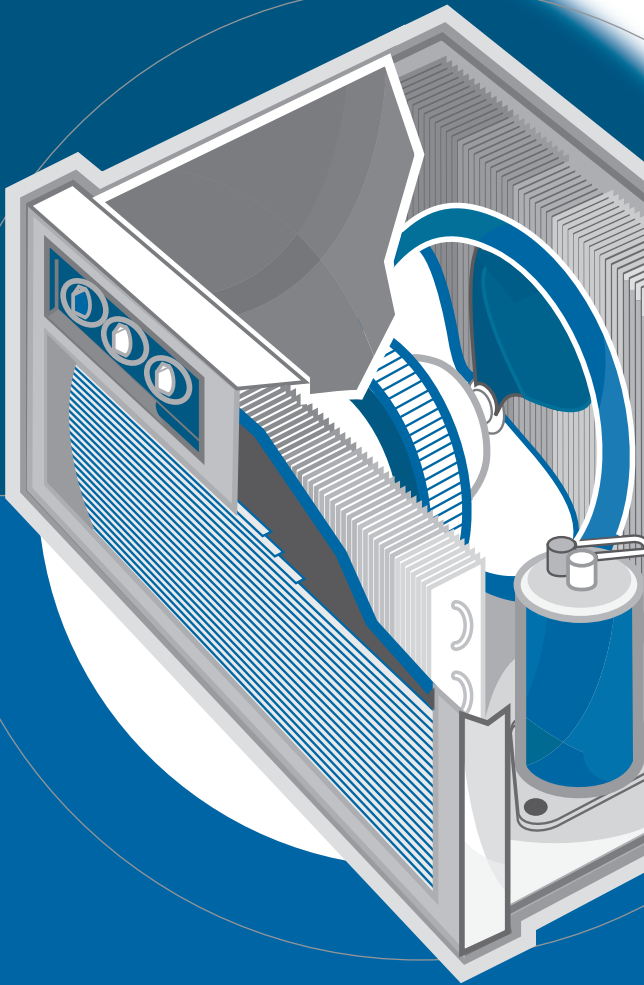

# Air Conditioning Your Home



Natural Resources  
Canada

Ressources naturelles  
Canada

Canada



## **Air Conditioning Your Home**

Produced by  
Natural Resources Canada's  
Office of Energy Efficiency  
**EnerGuide**

The Heating and Cooling Series is published by EnerGuide of Natural Resources Canada's Office of Energy Efficiency. EnerGuide is the official Government of Canada mark associated with the labelling and rating of the energy consumption or energy efficiency of household appliances, heating and ventilation equipment, air conditioners, houses and vehicles.

EnerGuide also helps manufacturers and dealers promote energy-efficient equipment and provides consumers with the information they need to choose energy-efficient residential equipment.

Improving energy efficiency reduces greenhouse gas (GHG) emissions that contribute to climate change.

By using energy efficiently and making wise consumer choices, you can reduce your individual GHG emissions by one tonne, or about 20%. Like most Canadians, you probably already take steps to conserve resources and protect the environment. Now the One-Tonne Challenge calls on you to make a bigger commitment.

## **Air Conditioning Your Home**

Rev. ed.

### **Canadian Cataloguing in Publication Data**

The National Library of Canada has catalogued this publication as follows:

Air Conditioning Your Home

(Home Heating and Cooling Series)

Issued also in French under title: Climatiser sa maison

ISBN 0-662-37481-9

Cat. No. M143-2/7-2004E

1. Dwellings – Air conditioning – Handbooks, manuals, etc.
2. Dwellings – Energy conservation.
  - I. Canada. Natural Resources Canada.
  - II. Series.

TH7687.A37 1996 697.9'38 C96-980184-X

© Her Majesty the Queen in Right of Canada, 2004

Reprinted November 2004

*Aussi disponible en français sous le titre :*

*Climatiser sa maison*

To receive additional copies of this free publication, write to  
Energy Publications

Office of Energy Efficiency

Natural Resources Canada

c/o S.J.D.S.

1770 Pink Road

Gatineau QC J9J 3N7

Tel.: 1 800 387-2000 (toll-free)

Fax: (819) 779-2833

In the National Capital Region, call 995-2943.

TTY: (613) 996-4397 (teletype for the hearing-impaired)

You can also view or order several of the Office of Energy Efficiency's  
publications on-line.

Visit our Energy Publications Virtual Library at

**[oee.nrcan.gc.ca/infosource](http://oee.nrcan.gc.ca/infosource)**.

The Office of Energy Efficiency's Web site is at **[oee.nrcan.gc.ca](http://oee.nrcan.gc.ca)**.



Recycled paper



|  |    |
|--|----|
| <b>Introduction</b> .....  | 1  |
| <b>Types of Air Conditioners</b> .....   | 4  |
| <b>Coming to Terms with Air Conditioners</b> .....                               | 5  |
| <b>Energy Efficiency Regulations – Labelling, Rating and Certification</b> ..... | 7  |
| Room air conditioners .....  | 8  |
| Central air conditioners .....   | 12 |
| <b>Room Air Conditioners</b> .....   | 14 |
| How does a room air conditioner work? .....                                      | 15 |
| Energy efficiency considerations .....   | 16 |
| Sizing considerations .....  | 17 |
| Installation considerations .....  | 17 |
| Operation considerations .....   | 19 |
| Other selection considerations .....   | 19 |
| Maintenance .....  | 21 |
| Operating costs .....  | 22 |
| Life expectancy and warranties .....   | 22 |
| <b>Central Air Conditioners</b> .....  | 23 |
| How does a central air conditioner work? .....                                   | 23 |
| Energy efficiency considerations .....   | 24 |
| Sound considerations .....   | 26 |
| Sizing considerations .....  | 26 |
| Installation considerations .....  | 26 |
| Operation considerations .....   | 28 |
| Maintenance .....  | 29 |
| Operating costs .....  | 30 |
| Life expectancy and warranties .....   | 31 |
| Replacing an existing central air conditioner .....                              | 31 |
| <b>Air-Conditioning Operating Costs</b> .....                                    | 32 |
| Factors affecting cost .....   | 32 |
| Method of calculating annual energy cost .....                                   | 33 |
| <b>Answers to Some Commonly Asked Questions</b> .....                            | 37 |
| <b>Annex A. Capacity Estimation Procedure for Room Air Conditioners</b> .....    | 41 |
| <b>Need More Information?</b> .....  | 46 |



## INTRODUCTION

---

In summer, high relative humidity, elevated air temperatures and bright sunshine can sometimes combine to produce an uncomfortable indoor environment. An air-conditioning system can provide comfort for occupants by lowering the air temperature and the humidity level in the home.

Options that are open to the consumer include a room air conditioner, a central air conditioner or a heat pump. The best choice of system will depend on your circumstances; therefore, it is worthwhile taking the time to evaluate your needs.

Does the whole house need to be air-conditioned or would cooling in one or two rooms be sufficient? Room air conditioners offer an effective, low-cost approach to providing comfort in a small space, up to three rooms, with minimum installation effort. Central air conditioners and heat pumps are used to cool the entire space. Central air conditioners are cooling-only products, whereas heat pumps provide winter heating as well. The cost of a heat pump is greater than that of a central air conditioner, which is greater than that of a room air conditioner. The choice between central air conditioners and heat pumps is examined in Natural Resources Canada's booklet *Heating and Cooling With a Heat Pump*.

If you are currently renting your home or apartment or if you are planning to move in the near future, a significant investment in either a central air-conditioning system or a heat pump probably does not make sense. However, a room air conditioner can be moved with you and re-installed in another residence.

If your home has a central air-duct system and an acceptable place to mount the outdoor unit (see "Installation considerations," page 26), installation of a central air conditioner or heat pump should be straightforward.

In bungalows with unfinished basements, the addition of a duct system may be relatively simple and inexpensive, but in other cases, this option is usually expensive and frequently impractical. In these cases, there are two other options for central systems:

- Mini-split units that distribute cooling by using two or three indoor sections connected to a single outdoor unit.
- Central air-conditioning systems that use small-diameter high-pressure ducts, designed to facilitate retrofit installation through walls, floors and attic spaces.

There are a number of things that you can do to reduce the need for mechanical cooling in your home, thereby minimizing the capacity and cost of the equipment that you purchase and the amount of electricity that it will consume. Actions you can take to reduce cooling requirements are as follows:

- Caulk and weatherstrip to seal air gaps, and ensure that the attic and exterior walls are insulated to meet or exceed the minimum recommended levels to minimize heat transfer to the interior.
- Use awnings, blinds or drapes to keep direct sunlight from entering the living space. Deciduous trees planted on the south and west sides of the house and wide roof overhangs will reduce solar heat gain to the interior in summer, while having only a small effect on heating in winter. Light-coloured exterior finishes will also help reduce solar heat gain year-round.
- Turn on the kitchen rangehood fan when cooking, if it exhausts outside, and turn on the bathroom fan while bathing to minimize moisture buildup in the space.
- Turn off lights and appliances that are not needed. Plan heat- and moisture-generating activities (cooking, dish washing, drying clothes and bathing) for cooler morning and evening hours. Consider using appliances with time-delay controls. In addition to generating heat and humidity at a less noticeable time (after midnight,

for example), your air conditioner will operate more efficiently in the cooler night hours.

- Select compact fluorescent lamps and energy-efficient appliances, since they produce less waste heat than conventional products. The electricity consumed by a less efficient refrigerator, for example, is converted to heat, which is released into your kitchen.

There are several common heat sources in a house.

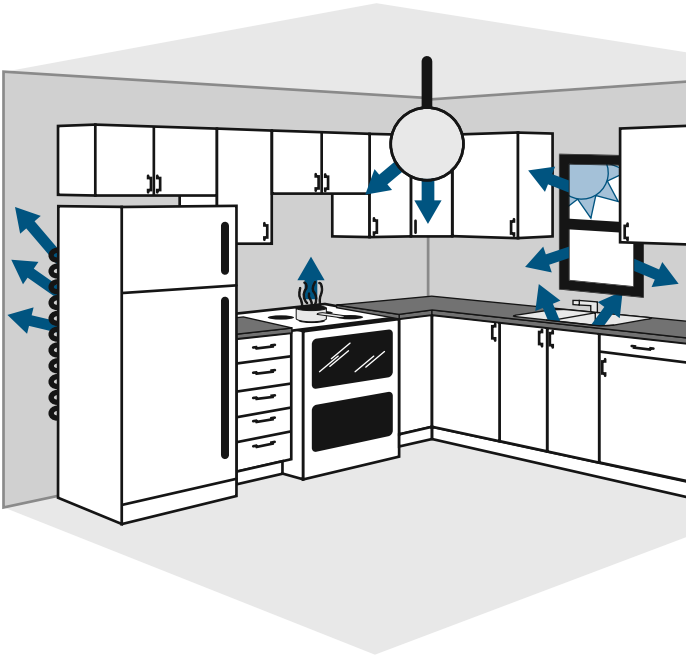

Becoming informed about all aspects of air conditioning your home is the way to ensure that the correct choices are made for your particular cooling needs. This booklet identifies the commonly available air-conditioning equipment and discusses factors involved in selecting, installing, operating and maintaining an air-conditioning system. It provides you with a sound basis for making a smart purchasing decision.



## TYPES OF AIR CONDITIONERS

As mentioned previously, there are two basic types of air conditioners – room air conditioners and central air conditioners. However, there are several different kinds within each type. Variations of room air conditioners are as follows:

- **Window-mounted** types are available for installation in single- and double-hung windows, as well as for horizontal sliding windows and even casement windows.
- **Wall-mounted** units use a sleeve to allow for through-the-wall mounting instead of window mounting.
- **Free-standing portable** units are easily moved on casters; some require temporary ducting to the outdoors.

Variations of central air conditioners are as follows:

- A **single-package** unit contains all the components and generally mounts through the wall or on the roof. Ducting to and from the unit conveys air to and from the rooms. This type is not commonly used in residential applications.
- A **split-system** unit consists of indoor and outdoor sections. The indoor heat exchanger, or coil, mounts above the furnace, inside the ducting. The outdoor section consists of the remaining components, and the two sections are joined by refrigerant lines connecting the indoor coil to the refrigeration components in the outdoor section.
- A **mini-split** unit is similar to a split-system but contains more than one indoor coil connected to one outdoor unit. Some mini-split units have as many as three indoor units. These units are ideal for homes with new additions, as there is no need for ductwork. The indoor section simply mounts on an inside wall, the ceiling or the floor. The outdoor and indoor units generally have a very slim profile compared to conventional split-systems. The

efficiency of mini-split units tends to be lower than other split-systems, which needs to be taken into account when considering such a unit.

- A **mini-duct** unit is a central air conditioner where the indoor section is installed in the attic, and air is distributed through plastic pipes in partition walls to outlets and inlets. These units can be retrofitted in homes with electric or hydronic baseboard heating that have no ductwork.
- Finally, **water-cooled** residential air conditioners can be connected to city or well water. Check with local authorities to determine if water-cooled equipment is permitted. These types are seldom used in Canadian applications, even if permitted, because operating costs would include electricity, as well as water and sewer charges.

The remaining sections provide more information on the two basic types of air conditioners.

## COMING TO TERMS WITH AIR CONDITIONERS

Here are some common terms you will come across when comparing and determining the best choice for air conditioners:

### COMPONENTS OF AN AIR CONDITIONER

The **refrigerant** is a substance that circulates through the air conditioner, alternately absorbing, transporting and releasing heat.

A **coil** is a system of tubing loops through which refrigerant flows and where heat transfer takes place. The tubing may have fins to increase the surface area available for heat exchange.

The **evaporator** is a coil that allows the refrigerant to absorb heat from its surroundings, causing the refrigerant to boil and become a low-temperature vapour.

The **compressor** squeezes the molecules of the refrigerant gas together, increasing the pressure and temperature of the refrigerant.

The **condenser** is a coil that allows the refrigerant gas to give off heat to its surroundings and become a liquid.

The **expansion device** releases the pressure created by the compressor. This causes the temperature to drop and the refrigerant to become a low-temperature vapour/liquid mixture.

The **plenum** is an air compartment that forms part of the system for distributing warmed or cooled air through the house. It is generally a large compartment immediately above the heat exchanger.

#### **OTHER TERMS**

A **Btu/h**, or British thermal unit per hour, is a measure of the heat output of a heating system. One Btu is the amount of heat energy given off by a typical birthday candle. If this heat energy were released over the course of one hour, it would be the equivalent of 1 Btu/h.

A **kW**, or kilowatt, is equal to 1000 watts. This is the amount of power required by ten 100-watt light bulbs.

A **ton** is a measure of cooling capacity. It is equivalent to 3.5 kW or 12 000 Btu/h.

The **capacity** of an air conditioner is a measure of the maximum rate at which it can remove heat from the conditioned space. Capacity is expressed in British thermal units per hour or tons and is determined under a specific set of test conditions.

The **cooling load**, also stated in British thermal units per hour, is the maximum amount of heat that builds up in a space without a cooling system operating. It is calculated to determine the capacity of air conditioner required.

**Heat gain** is a term applied to various components of the heat load, such as appliance heat gain and solar heat gain. All of the heat gain components are summed to calculate the cooling load.

**Oversizing** is the practice of selecting an air conditioner with a cooling capacity greater than the cooling load.

**Undersizing** is the practice of selecting an air conditioner with a cooling capacity smaller than the cooling load.

The **energy efficiency ratio (EER)** is a measure of how much cooling effect is provided by the air conditioner for each unit of electrical energy that it consumes under steady-state operation. It is determined by dividing the cooling output of the unit, in British thermal units per hour, by the electrical power input, in watts, at a specific temperature. The higher the EER, the more efficient the unit.

The **seasonal energy efficiency ratio (SEER)** is a measurement of the cooling efficiency of the air conditioner over the entire cooling season. It is determined by dividing the total cooling provided over the cooling season, in British thermal units per hour, by the total energy used by the air conditioner during that time, in watt/hours. The SEER is based on a climate with an average summer temperature of 28°C.

The **bel (B)** is a unit of sound measurement equivalent to 10 dB (decibels). One bel is the threshold of human audibility. The sound level in a busy typing and accounting office would be approximately 6.5 B.

## **ENERGY EFFICIENCY REGULATIONS – LABELLING, RATING AND CERTIFICATION**

Both room air conditioners and central air conditioners are covered under Canada's *Energy Efficiency Regulations*, which came into effect February 3, 1995. These regulations, which cover several types of energy-using products, help

Canadians save money and protect the environment by reducing electricity demand. Improving energy efficiency reduces greenhouse gas (GHG) emissions that contribute to climate change. Under the Regulations, energy-using products, such as room air conditioners and central air conditioners, must meet minimum efficiency standards of performance if they are to be imported into Canada or shipped across provincial and territorial boundaries.

## Room air conditioners

The *Energy Efficiency Regulations* specify that room air conditioners must carry an EnerGuide label, which helps you obtain consistent and reliable information about the relative energy efficiency of room air conditioners on the market.

### THE ENERGUIDE LABEL FOR ROOM AIR CONDITIONERS

You may already be familiar with the EnerGuide label found on major electrical household appliances, such as refrigerators, ranges, freezers, dishwashers, clothes washers and clothes dryers. Although the label for room air conditioners (see Figure 1) looks similar to the one found on appliances, it is quite different. The large bold number found on the EnerGuide label for room air conditioners is known as the **EER** of the unit, and the **higher** the EER, the **more efficient** the room air conditioner. The inverted triangle and the graduated bar can be used to compare the performance of a particular model with others of the same class. Class refers to the type (louvred or non-louvred) and cooling capacity category, which are indicated near the bottom of the label. The further the triangle is to the **left** of the scale, the **less efficient** it is. The further the triangle is to the **right** of the scale, the **more efficient** it is.

To further help you choose energy-efficient room air conditioners, Natural Resources Canada (NRCan) publishes the *EnerGuide Room Air Conditioner Directory*. It ranks room air conditioners by type and cooling capacity, starting from the highest EER to the lowest. See “Need More Information?” on page 46 to find out how to order a copy of this directory.

**Figure 1** EnerGuide label for room air conditioner

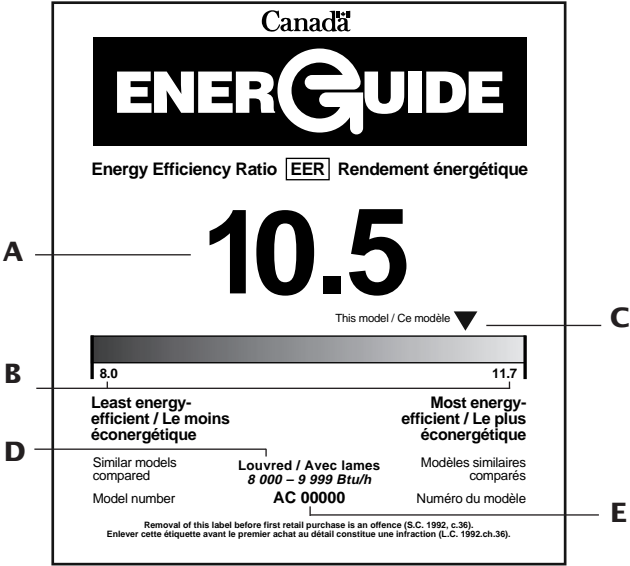

Sample room air conditioner EnerGuide label

Note: The EnerGuide label for room air conditioners always compares models of the same type and with similar cooling capacities.

- A** This number shows the energy efficiency ratio – EER – of the room air conditioner model. The EER is based on a Canadian Standards Association (CSA) test procedure that manufacturers must follow.
- B** The numbers shown on the left and right of this line indicate the range of EERs available for similar models (same type and similar cooling capacity) during one year.  
 The number on the right is the most energy-efficient model produced or available in a given year, as listed with EnerGuide.  
 The number on the left of this line is the EER of the least efficient model produced or available in a given year, as listed with EnerGuide.  
 The numbers on this scale are provided by EnerGuide to all manufacturers and dealers, and are updated every year to reflect new models introduced in Canada.
- C** This triangle places the EER of the model on the label in comparison with the least and most efficient EERs (numbers on the left and right) of models of the same type and with similar cooling capacities.
- D** This is the type and cooling capacity category. Types are either louvred or non-louvred. Cooling capacity category is in Btu/h.
- E** This is the actual model number of the unit on which the label should be placed.

## **ENERGY STAR® means high energy efficiency**



EnerGuide now has a powerful new ally: the international ENERGY STAR symbol. While EnerGuide provides comparative information on the energy consumption of different products, the ENERGY STAR symbol on a room air conditioner or on its EnerGuide label assures you that the unit is one of the top energy performers on the market.

**Consumers now recognize the ENERGY STAR symbol as a symbol for energy efficiency.**

ENERGY STAR®



**Look for the new ENERGY STAR symbol in 2004.**



To qualify for the ENERGY STAR symbol, a room air conditioner must meet a standard of premium energy efficiency. To earn this status, a room air conditioner must exceed the Government of Canada's minimum standard of energy efficiency by at least 10 percent. See the table on the next page for details on ENERGY STAR performance levels.

New for 2004: ENERGY STAR performance levels for thorough-the-wall and casement units.

| TYPE                         | WINDOW-MOUNTED<br>(LOUVRED SIDES)            | THROUGH-THE-WALL<br>(WITHOUT LOUVRED SIDES)    |
|------------------------------|--|--|
|                              | <b>Cooling Capacity<br/>(Btu/h) Standard</b> | <b>Minimum EER to be ENERGY STAR qualified</b> |
| Less than 6 000              | 10.7   | 9.9  |
| 6 000 to 7 999               | 10.7   | 9.9  |
| 8 000 to 13 999              | 10.8   | 9.4  |
| 14 000 to 19 999             | 10.7   | 9.4  |
| 20 000 and over              | 9.4  | 9.4  |
| <b>Casement-only – all</b>   | 9.6  |  |
| <b>Casement-slider – all</b> | 10.5   |  |

Note: Units with heating elements or reverse cycles (i.e. mini heat pumps) do not qualify for ENERGY STAR.

By replacing your old air conditioner with an ENERGY STAR qualified model, you can realize substantial savings in electricity costs. Today's ENERGY STAR qualified units use 30 to 40 percent less energy than most models sold 10 to 15 years ago.

Room air conditioners contribute more to the summer peak demand for electricity from the electricity grid than any other household appliance. On hot days, when the demand for electricity for air conditioning increases, the generation of coal-fired electricity can soar, with a corresponding increase in nitrogen oxides (NO<sub>x</sub>), sulphur oxides (SO<sub>x</sub>), carbon dioxide (CO<sub>2</sub>) and other emissions that lead to smog, acid rain and climate change.

By choosing an ENERGY STAR qualified room air conditioner, you can help the environment and realize significant electrical savings.

For more information on ENERGY STAR in Canada, visit the Web site at [energystar.gc.ca](http://energystar.gc.ca) or call 1 800 387-2000 toll-free.



## **Certification**

The room air conditioner EER and cooling capacity are determined in accordance with the Canadian Standards Association (CSA) Standard C368.1-M90, which specifies methods of testing, test conditions and tolerances.

Certification organizations accredited by the Standards Council of Canada, such as CSA, operate energy efficiency verification services for manufacturers, distributors and importers of room air conditioners to help them demonstrate compliance with federal and provincial regulations. These verification services assess the products' performance against mandated requirements and put in place a process to ensure that production units continue to meet these requirements.

## **Central air conditioners**

As mentioned earlier, central air conditioners must meet minimum efficiency standards of performance under Canada's *Energy Efficiency Regulations*, as well as under similar regulations in many provinces. These regulations specify the minimum seasonal energy efficiency ratio (**SEER**) for central air-conditioning equipment.

### **THE ENERGUIDE RATING FOR CENTRAL AIR CONDITIONERS**

NRCan and the Heating, Refrigerating and Air Conditioning Institute of Canada (HRAI) have established an industry-managed energy efficiency rating system for furnaces, central air conditioners and heat pumps. The energy efficiency rating scale appears under the EnerGuide logo on the back of the manufacturers' brochures (see Figure 2). As with the EnerGuide label for room air conditioners, the inverted triangle and graduated bar can be used to compare a particular model with other model designs and types.

**Figure 2** EnerGuide rating for central air conditioners and heat pumps

Air conditioner and heat pump (cooling mode) energy efficiency is measured by SEER (seasonal energy efficiency ratio). The higher the number, the more energy efficient the model.

Note: There is an EnerGuide rating for every model, not just for the most energy-efficient ones.

Lowest energy efficiency level permitted for sale in Canada for central air conditioners and heat pumps (cooling mode) in accordance with provincial and federal regulations.

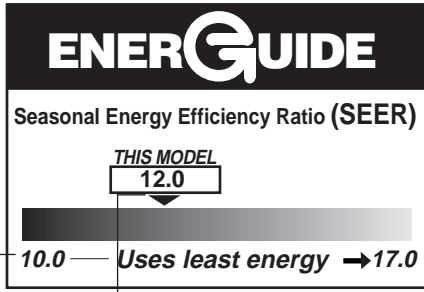

This indicator tells you the energy efficiency of the model featured in the brochure, compared with the SEER rating of all units available for sale in Canada. In some cases, there may be a range of numbers shown in this box and two arrows pointing to the rating line. This indicates that there is more than one model or size referenced in the brochure. The range represents the lowest and the highest SEER ratings for the models featured in the brochure.

Highest SEER available in Canada for this type and category of model.

## Certification

The central air conditioner SEER and cooling capacity are determined in accordance with CSA Standard C273.3-M91: *Performance Standard for Split-System Central Air Conditioners and Heat Pumps*. The standard specifies the tests and calculation procedures to be used to determine SEER and capacity ratings. The standard also specifies the minimum efficiency requirements.

Certification organizations accredited by the Standards Council of Canada, such as CSA, operate energy efficiency verification services for manufacturers, distributors and importers of central air conditioners to help them demonstrate compliance with federal and provincial regulations. These verification services assess the products' performance against mandated requirements and put in place a process to ensure that production units continue to meet these requirements.



Today's ENERGY STAR<sup>®</sup> qualified central air conditioners use up to 20 percent less energy than standard new central air conditioners. The ENERGY STAR specification for central air conditioners requires that the EnerGuide SEER rating be 12.0 or greater for a single-package unit and 13.0 or greater for a split system.

Central air conditioners are major contributors to the summer peak demand for electricity from the electrical grid. On hot days, when the demand for electricity for air conditioning increases, the generation of coal-fired electricity can soar, with a corresponding increase in  $\text{NO}_x$ ,  $\text{SO}_x$ ,  $\text{CO}_2$  and other emissions that lead to smog, acid rain and climate change.

By choosing to buy an ENERGY STAR qualified central air conditioner that is sized correctly for your home, you can help to reduce GHGs and smog precursors, realize substantial electrical savings and increase your household's comfort.

## ROOM AIR CONDITIONERS

A room air conditioner is essentially a smaller version of a central air conditioner and is intended to cool only a small area, usually one room. Powered by electricity, it removes heat from the living space to maintain comfort conditions during hot, humid weather and conveys it to the outdoors. Unlike a central air conditioner, no ductwork is required, and all components are built into a single package that is mounted in a window opening or through the wall (Figure 3). Smaller

**Figure 3** Components of a room air conditioner

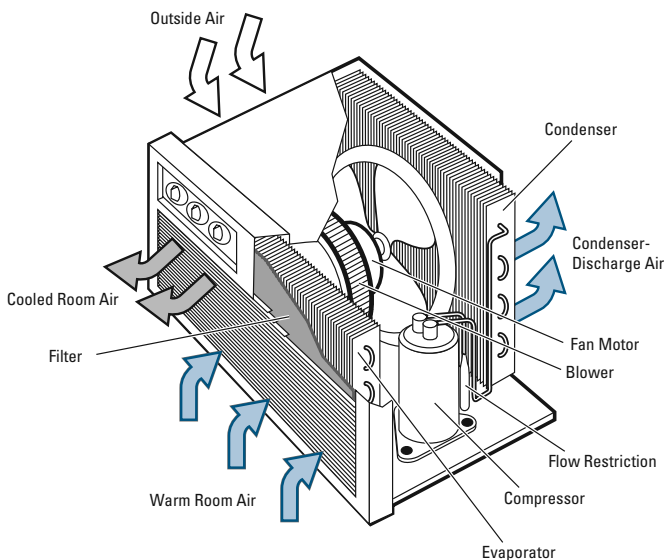

capacity room air conditioners are portable, as they are easily moved from one room or residence to another. Two major categories of room air conditioners are available: units with louvred sides that are intended for installation in window openings, which are the most common type, and units without louvred sides intended for through-the-wall installation.

## How does a room air conditioner work?

Room air conditioners function in much the same way as refrigerators do – heat is extracted from the space that is being cooled and is conveyed outside of that space.

A fan circulates room air through the evaporator, which contains low-pressure refrigerant (see Figure 4). Evaporation of the refrigerant cools the tubes and fins, extracting heat from the air and causing moisture in the air to condense on the evaporator's outer surface. The cooler, drier air is returned to the room, and the gaseous refrigerant leaving the evaporator is drawn into the compressor where mechanical compression raises its temperature and pressure. The hot, high-pressure refrigerant passes through the condenser, where it loses heat to outdoor air (which is blown over it with a second fan) and condenses. This high-pressure liquid refrigerant passes through a restriction and into the low-pressure side of the circuit, and the entire process is repeated.

**Figure 4** Basic cooling cycle

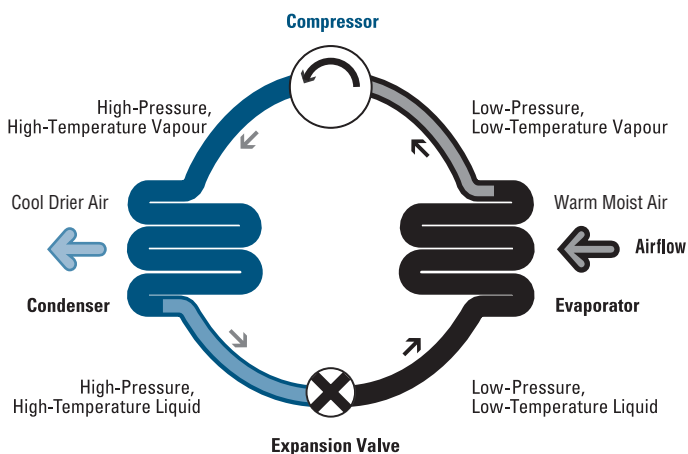

# Energy efficiency considerations

The efficiency of room air conditioners in converting electricity into cooling effect varies widely, depending on the manufacturer's design choices. Models for window mounting are available with EER ratings between 12.0 and 8.0, and units intended for through-the-wall applications have EERs between 9.5 and 8.0.



An ENERGY STAR<sup>®</sup> qualified window-mounted room air conditioner with a cooling capacity under 20 000 Btu/h must have an EER rating of at least 10.7.

High-efficiency units generally incorporate efficient rotary compressors, large evaporators and condensers with louvred fins and internally rifled tubes, as well as efficient fans and a slinger ring to deposit water collected from the evaporator onto the hot condenser. Minimum efficiency units tend to use small conventional heat exchangers and standard compressors and fans (Figure 5).

**Figure 5** Efficiency of a room air conditioner

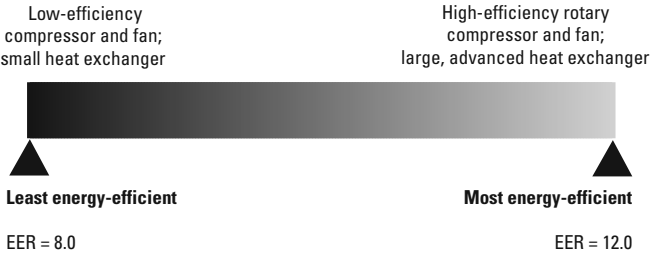

While higher efficiency units are more expensive to manufacture, retail prices do not necessarily reflect this premium. Select a unit with as high an EER as is practical, to minimize operating costs.

## **Sizing considerations**

The amount of cooling that the air conditioner must provide to maintain comfort conditions is called the cooling load. It is affected by the size of the room, the size and orientation of windows, attic and wall insulation levels, and the amount of heat being generated in the room, etc. As a rough rule of thumb, 200 Btu/h of room air conditioner capacity will be required to cool and dehumidify each square metre of living space. Ideally, the unit should be sized by a qualified air conditioning contractor, using detailed calculations that take into account the size of rooms, insulation levels, size and orientation of windows and doors, shading, number of occupants, appliances, lighting, climate, etc. Annex A, on page 41, provides a capacity estimation procedure for room air conditioners. Although this procedure is fairly detailed and complex, it can provide an accurate cooling load for your particular needs.

## **Installation considerations**

Room air conditioners are available in styles that are designed to be mounted either through the wall or in a window opening. There are considerably more window-mounted models available, providing you with a good choice of features and suppliers.

Through-the-wall units offer the advantage of leaving windows available for aesthetic reasons, natural lighting and ventilation, but they do require the construction of a special opening in the wall, which can be costly. If the air conditioner is to be left in place year-round, this approach should be considered as it lends itself to a tighter installation.

While there usually isn't any choice as to the orientation of a room air conditioner, a northern exposure is ideal, since solar heating of the unit is minimized.

Some room air conditioners can be quite heavy and awkward to handle. Ensure that you use enough helpers to make the

If possible, locate room air conditioners on a north wall or on a wall that is shaded.



installation a safe one. Once the unit is securely fastened in place, seal up all air leaks to avoid unnecessary air exchange (and cooling load) during air conditioner operation. Fill the large gaps using the panels or side curtains provided in the installation kit. Seal any remaining cracks with either *peelable* caulking or a sealant strip that stops draughts and can be removed without damaging the paint. An airtight seal will also prevent insects from entering the house through the air conditioner opening.

Some room air conditioners, particularly those with larger capacities, will require a dedicated electrical circuit or have specific requirements regarding the current rating of the wiring and the breaker. Before you buy, investigate your electrical system. Identify which other electrical loads are on the circuit that you plan to use, and with the help of an electrical contractor, check existing wiring to determine how much additional load can be safely added. If a new circuit is needed, it should be installed by a qualified electrical contractor and inspected for conformity with the electrical code.

## **Operation considerations**

The cost of operating a room air conditioner may be minimized by selecting a unit with a high EER and taking the simple steps listed below:

- Select the highest thermostat setting that results in acceptable comfort. A temperature of 25.5°C is usually recommended.
- If the space is going to be unoccupied for more than four hours, the thermostat should be turned up to achieve a temperature of about 28°C. If it will be unoccupied for more than 24 hours, it should be shut off.
- Keep the house closed up tight during hot days and use natural or forced ventilation at night, when the air is cooler. Use the “ventilate” or “outside air” control on the room air conditioner sparingly.
- Do not block the air conditioner vents with drapes or furniture.
- Use continuous air conditioner fan operation only when the resulting air movement is required to maintain comfortable conditions in the room.

## **Other selection considerations**

Choose an air conditioner with the proper cooling capacity for your application. An oversized unit may not stay on long enough to properly dehumidify the room, and an undersized unit will not be able to handle the cooling load in extremely hot weather. Determining the capacity required for your room is addressed in the section on sizing considerations (page 17).

Noise level inside the room is also an important consideration, particularly if the air conditioner is used in a bedroom. In some installations, a low outdoor-noise level is important; for example, when the unit is located opposite a neighbour’s bedroom window. Also, some jurisdictions have



noise-limiting by-laws that may restrict the operating hours of noisy equipment. Noise levels for room air conditioners are sometimes reported by independent consumers' groups but are seldom found in manufacturers' literature.

Good control over the direction and distribution of cool air from the unit is also important. Consider whether you need a high-velocity jet of cool air to penetrate well into a large room or if there are specific regions that cool air should be directed away from. Select a unit with appropriate louvre adjustments to fit your needs.

Controls should also match your requirements. Generally, two or three fan speeds are available. In normal operating mode, the fan runs continuously. Some models have an energy-saver mode that turns the fan off at the same time as the compressor; others have a timer that can turn the air conditioner on and off at preset times; and some units can be turned on or off.

Most units can exchange stale room air with outdoor air through fan operation without the compressor running; however, ventilation rates are generally modest.

Room air conditioners usually weigh 25 kg or more and can be quite bulky. Consider design features, such as a slide-out chassis, that improve the ease and safety of installation and removal.

Although room air conditioners are generally considered to be reliable appliances, the security offered by a manufacturer's warranty can provide peace of mind and valuable protection if failures do occur.

## Maintenance

- Clean the air filters at least once each season. A dirty air filter reduces airflow and, in some cases, this could cause damage to the room air conditioner.
- Keep the condenser clean and free of leaves and other debris.
- Clean condensate drain holes or tubes that become blocked.
- If the unit's performance seems to have deteriorated, have it serviced. A small loss of refrigerant can cause a significant drop in efficiency. It is important to have leaks fixed and that the refrigerant be recycled when service is performed. Otherwise, if it is released into the atmosphere, it damages the ozone layer and acts as a greenhouse gas.

Clean air conditioner air filters regularly.

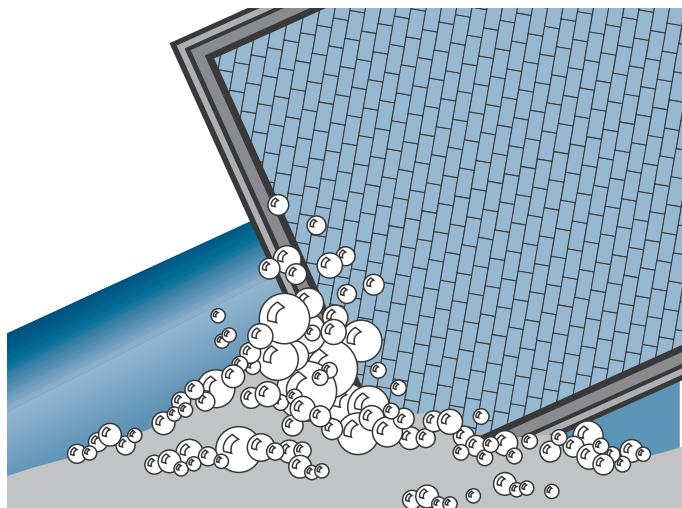

- Check your owner's manual or contact your service technician about the correct maintenance schedule for your unit. Some models require additional attention, such as periodic oiling of the fan motor.

## **Operating costs**

The cost of operating a room air conditioner will depend on the cost of electricity in your area, the cooling capacity, the EER of the unit and, most importantly, the amount of time that it operates. The weather and the factors highlighted in the “Operation considerations” section, on page 19, will significantly influence the number of hours that it runs each year.

NRCan’s *EnerGuide Room Air Conditioner Directory* includes conversion tables that provide the approximate energy consumption, in kilowatt hours, of different room air conditioners for different locations across Canada. You can use these tables to estimate the operating cost for your location, air conditioner capacity and EER rating. See the section of this booklet entitled “Need More Information?” on page 46 to find out how to order a copy of the directory.

Remember that the way you operate the unit can have a large impact on the actual operating cost: heavily used room air conditioners run for three or four times as many hours as their seldom used counterparts.

## **Life expectancy and warranties**

In general, room air conditioners are expected to have a service life of approximately 10 years. Lower annual run-time results in a greater than average life expectancy.

Warranties vary from one manufacturer to another. Frequently, some form of five-year warranty is offered with complete parts and labour coverage in the first year. Subsequent coverage is usually limited to, for example, the cost of sealed refrigeration-system parts being covered. Check warranty details before buying.

# CENTRAL AIR CONDITIONERS

Central air conditioners are designed to cool the entire house. The large compressor and outdoor coil are located outdoors and are connected by refrigerant lines to an indoor coil mounted in the furnace (Figure 6). The same duct system is used for both heating and cooling air distribution.

**Figure 6** Installed central air conditioner

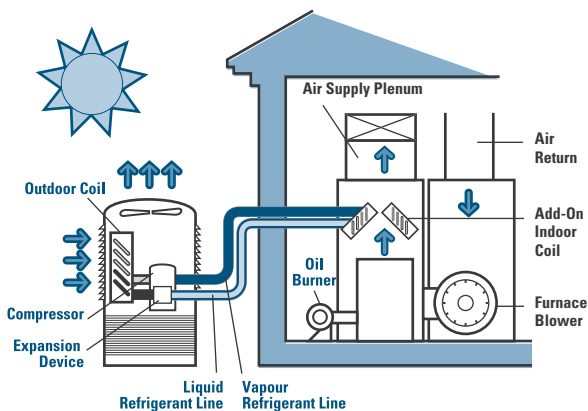

## How does a central air conditioner work?

A central air conditioner uses energy to take heat away. The most common type uses a compressor cycle (like a refrigerator), illustrated in Figure 7, to transfer heat from the house to the outdoors. Using a special fluid called a refrigerant, heat is absorbed and released when the refrigerant changes back and forth between a liquid and gas state. As it changes from liquid to gas, it absorbs heat; in changing back to a liquid from a gas, it releases heat.

The compressor cycle passes liquid refrigerant through an expansion device, changing the liquid to a low-pressure liquid/gas mixture. In the indoor coil or evaporator, the remaining liquid absorbs heat from household air and becomes a low-temperature gas.

**Figure 7** The operation of a central air conditioner

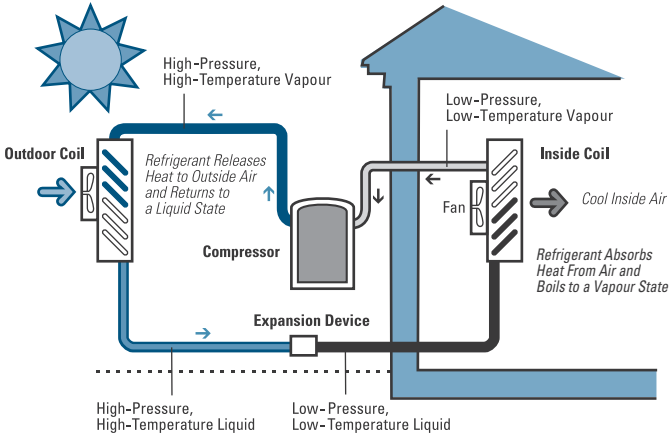

The low-temperature gas is compressed by a compressor that reduces its volume and increases its temperature, causing it to become a high-pressure, high-temperature vapour. This vapour is sent to the outdoor coil or condenser where its heat is transferred to the outdoor air, causing the refrigerant to condense into a liquid. The liquid returns to the expansion device and the cycle is repeated.

Household air is cooled and dehumidified as it passes over the indoor coil. The moisture removed from the air, when it contacts the indoor coil, is collected in a pan at the bottom of the coil and sent to a house drain.

## Energy efficiency considerations

Select a central air conditioner with as high a SEER as is practical within your budget. The annual cooling efficiency of a central air conditioner is affected by the manufacturer's choice of features and components. The SEER of central air conditioners ranges from a minimum of 10.0 to a maximum of about 17.0.



An ENERGY STAR<sup>®</sup> qualified central air conditioner must have a SEER rating of at least 12 or greater for a single-package unit and 13.0 or greater for a split system.

More efficient compressors, larger and more effective heat exchanger surfaces, improved refrigerant flow and other features are largely responsible for recent improvements in the efficiency of central air conditioners.

**Figure 8** Efficiency of a central air conditioner

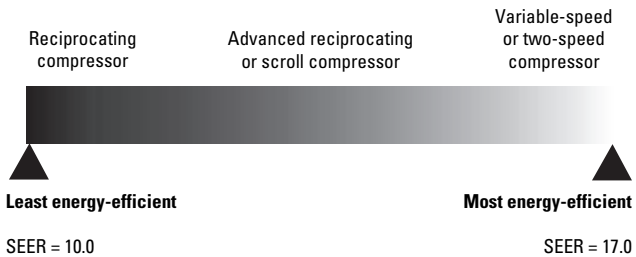

Advanced reciprocating, scroll and variable-speed or two-speed compressors, when combined with the current best heat exchangers and controls, permit SEERs as high as 17.0 (Figure 8). Central air conditioners with the highest SEERs always use variable-speed or two-speed high-efficiency compressors.

## **Sound considerations**

Select a central air conditioner with an outdoor sound rating of about 7.6 B or lower, if possible. The sound rating is expressed in bels. The lower the sound rating, the lower the sound power emitted by the outdoor unit. New, energy-efficient designs often have low sound ratings. The ratings are published by the Air-Conditioning and Refrigeration Institute (ARI), 4301 North Fairfax Drive, Arlington, Virginia, 22203 U.S.A.

## **Sizing considerations**

Cooling loads should be determined by a qualified air-conditioning contractor, using a recognized sizing method such as that specified in CSA-F280-M90: *Determining the Required Capacity of Residential Space Heating and Cooling Appliances*. Do not rely on simple rules of thumb for sizing, but insist on a thorough analysis from the sales representative.

Select a central air conditioner size or capacity to just meet the design cooling-load calculated. Oversizing the unit will result in short operating cycles, which will not adequately remove humidity, resulting in an unpleasantly cold and damp home. Undersizing the unit will result in an inability to attain a comfortable temperature on the hottest days.

Also, with a central air conditioning system, the equipment cost is much more proportional to size than it is with heating equipment. Unnecessary oversizing will increase the purchase price and increase on-and-off cycling, which will decrease the unit's overall efficiency.

## **Installation considerations**

When installing a central air conditioner, it is important that the contractor follow the manufacturer's instructions carefully.

The outside compressor for a central air conditioner should be shaded from direct sun.

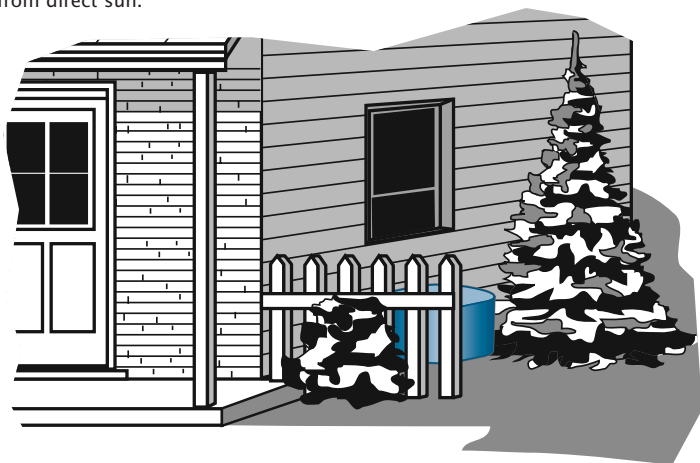

The following general guidelines should be considered when installing a central air conditioner:

- Locate the outdoor unit or condenser in a cool, shaded place where the waste heat can be readily rejected.
- Locate the outdoor unit where its noise will not be a problem for you or your neighbour. This generally means away from bedroom windows or patios and not between houses.
- In new construction, consider installing the central air conditioner outdoor unit on a frame mounted to the house. This avoids problems due to settlement of backfill around the foundation, which causes the outdoor unit to lose its level.
- The central air conditioner will generally require more airflow than the furnace needs for heating. Consider a two-speed fan motor with the correct speed automatically selected depending on whether cooling or heating is called for.
- Keep refrigerant lines as short as possible, and where the lines pass through the outside wall, ensure that the surrounding space between the lines and the wall is packed with a resilient material, such as plumber's putty. This will prevent noise or vibration problems and air leaks.



The cost of installing a central air conditioner will vary depending on the nature of the existing furnace, whether or not the existing ductwork needs to be modified, and whether there is a need to upgrade the electrical service to deal with the increased electrical load of the central air conditioner.

Where an existing central air conditioner is being replaced, ensure that the existing indoor coil is replaced by one matched to the new outdoor unit. If the existing indoor coil is not replaced, the new unit will not deliver its rated efficiency.

## **Operation considerations**

In the interest of energy efficiency, use central air conditioning only when ventilation is inadequate to ensure comfortable conditions. Natural ventilation of the house at night, when it is relatively cool, combined with closing up the house during hot days and running the central air conditioner can be an effective strategy.

The indoor thermostat should be set somewhere in the range of 22–25°C, depending on your comfort requirements. A setting at the higher end of the range will result in lower air-conditioning costs. If the humidity level is lower, temperature settings can be at the higher end. Humidity levels can be reduced by using a bathroom exhaust fan when you bathe or shower and by using a range-hood fan, if it is vented outside, when cooking on the range top.

Continuous indoor fan operation can keep the temperature more uniform throughout the house by eliminating temperature differences due to stratification. It can also help keep the home cleaner, especially if there is an electronic air cleaner installed.

However, continuous indoor fan operation can increase operating costs compared with on-off or automatic fan operation. In more humid climates, the moisture removed during compressor operation is re-evaporated by the fan

operation when the compressor is off. This can increase humidity levels and cause discomfort.

As in winter, adjusting the thermostat when the house is unoccupied can reduce operating costs. If the house will be empty during the day, you can raise the thermostat a few degrees before you leave and reset it to the preferred temperature when you return. An automatic programmable thermostat will reliably adjust the temperature for you to help you save money on cooling costs.

The power to the central unit should be shut off when the cooling season ends. Most central air conditioners have a small electric heater on the compressor to keep refrigerant out of the lubricating oil. Flip the circuit breaker to turn this heater off. To prevent damage to the compressor, remember to turn the power back on a day or two before you need to operate the central air conditioner.

## **Maintenance**

Proper maintenance is critical in ensuring that your central air conditioner will operate efficiently and have a long service life. You can do some of the simple maintenance yourself, but you may also want to have a competent service contractor do a periodic inspection of your unit. The best time to service a central air conditioner is just prior to the cooling season.

*Filter and coil* maintenance can have a dramatic impact on system performance and service life. Dirty filters and dirty indoor and outdoor coils and fans reduce airflow through the system. This reduction in airflow decreases system efficiency and capacity and can lead to expensive compressor damage if left for an extended period of time.

*Furnace filters* should be inspected and cleaned or replaced, depending on the type of furnace and the furnace manufacturer's instructions. The *outdoor coil* should be vacuumed or brushed clean to keep it clear of dirt, leaves and grass clippings. It can be carefully cleaned with a garden hose

after debris is vacuumed off. Consider a professional cleaning if the outdoor coil becomes badly plugged.

Both the furnace fan and outdoor unit fan should be cleaned and lubricated where applicable and following manufacturers' instructions. The furnace-fan speed can be checked and adjusted at the same time, to ensure peak performance.

*Ductwork* can be professionally cleaned if needed, but the need for cleaning can be reduced by a proper filter replacement and cleaning routine. To ensure that all ducts are airtight, seal the joints with a special duct mastic (sealant). This should reduce or eliminate air leaks. High-temperature duct tape may work, although it tends to degrade or permit air leaks over time. Be sure that *vents* and *registers* are not blocked by furniture, carpets or other items that can resist airflow. Extended periods of inadequate airflow can lead to compressor damage. For professional cleaning or supplies, look in the Yellow Pages™ under “Furnaces – Heating” or “Furnaces – Supplies and Parts.”

Using a high-efficiency air cleaner on a central cooling/heating system is one way of ensuring a clean indoor coil and a cleaner indoor environment.

If, after attending to filter maintenance and coil cleaning, your central air conditioner does not appear to be doing its job, you will need to hire a competent service contractor to undertake more difficult maintenance or service, such as checking the refrigerant level or making electrical or mechanical checks and adjustments.

## **Operating costs**

The operating cost of a central air conditioner is influenced by a number of factors, such as how much you use your air conditioner and how efficient it is, the amount of insulation and glazing in your home, and the frequency and duration of door and window openings when the system is operating.

It also depends on the activities in your home and the use of other equipment and appliances that increase the load on the air conditioner. Finally, it depends on the local climate and electricity costs.

The section of this guide entitled “Air-Conditioning Operating Costs,” on page 32, provides estimates of the cost of operating a central air conditioner in different regions of Canada.

## **Life expectancy and warranties**

The life expectancy of a central air conditioner is 15 years or longer. When the air conditioner starts giving more problems than seem cost-effective to fix – particularly when major components, such as a compressor, require replacement – it may be time to replace the central air conditioner. New units offer greater efficiency and lower operating costs; it may be more cost-effective in the long run to replace rather than repair.

The warranty on your equipment will vary according to the manufacturer. Air conditioner warranties range from one year for complete parts and labour to five years for the compressor. Some manufacturers are now offering 10-year warranties on their compressors. Make sure you fully understand the terms of a warranty. Ask the contractor or manufacturer for an explanation, if necessary.

## **Replacing an existing central air conditioner**

If your existing air conditioner needs replacement or is more than 10 years old, chances are good that it is also inefficient. A 10-year-old air conditioner probably has a SEER rating between 7.0 and 8.0, compared with some new models that are twice as efficient. The more efficient unit should pay for itself through decreased utility bills and offer improved reliability and warranty protection.

If you have an electric or oil furnace or a conventional gas furnace and your space heating costs \$1,000 or more per year, you should consider installing an efficient air-source or ground-source heat pump instead of a central air conditioner. Find out from two or three contractors how much more it would cost to add a heat pump to your furnace. Heat pump equipment SEER ratings are competitive with those of central air conditioners, but heat pumps have the added advantage of providing savings in heating costs during the winter.

Heat pump savings range from a low of about 20 percent, where gas is the primary heat source, to as high as 60 percent, where an electric furnace is the main source of heating. If the additional capital cost divided by the estimated savings is five years or less, consider installing a heat pump instead. They are good for the environment and are an efficient way of using electricity for home heating.

For more information about heat pumps, read the companion NRCan booklet *Heating and Cooling with a Heat Pump*. See the section of this booklet entitled “Need More Information?” on page 46 to find out how to order a copy.

## **AIR-CONDITIONING OPERATING COSTS**

If you are interested in purchasing an air conditioner, chances are that comfort is the main reason. However, cost is also a major factor. You may want to calculate the annual cost of operating an air conditioner to determine whether it is worth the investment. This section may also be valuable to you for comparing the performance and cost of equipment with identical cooling capacities before making a purchase decision.

### **Factors affecting cost**

Many factors affect the operating cost of an air conditioner:

- geographical location of the house

- variance of weather conditions from year to year
- efficiency rating of the air conditioner (SEER or EER)
- size of the air conditioner relative to house cooling load
- thermostat setting
- number of occupants in the house
- habits of people in the house – if windows are open or closed; if window shading is used; and frequency of appliance, cooking and lighting use
- local cost of electricity

## Method of calculating annual energy cost

### *Important note*

The following formulas are intended to provide an *estimate* of the operating cost of an air conditioner. The actual energy consumption can vary depending on several factors, including those listed in the previous section entitled “Factors affecting cost.”

The annual cost of operation of an air conditioner can be calculated as shown below. The method can also be used to provide an estimate of the energy-cost savings of using a more efficient (i.e. higher SEER or EER rating) air conditioner.

Formula for calculating the yearly operating cost of **central air conditioners**:

$$\text{Cost of operation} = \frac{24 \times DD_{C \cdot 18}}{T_{OD} - 18} \times \frac{CAP (35^\circ C)}{SEER} \times \frac{\text{Cost/kW}}{1000}$$

Formula for calculating the yearly operating cost of **room air conditioners**:

$$\text{Cost of operation} = \frac{24 \times DD_{C \cdot 18}}{T_{OD} - 18} \times \frac{CAP (35^\circ C)}{0.9 \text{ EER}} \times \frac{\text{Cost/kW}}{1000}$$

where,

**DD<sub>C.18</sub>** = number of cooling degree-days  
(base 18°C) from Table 1 (page 36)

**T<sub>OD</sub>** = summer outdoor design temperature (°C)  
for location from Table 1

**CAP (35°C)** = the capacity of the air conditioner  
(in Btu/h) at an entering air  
temperature of 35°C

**SEER** = the rated seasonal energy efficiency  
ratio (Btu/h/W)

**EER** = the rated energy efficiency ratio

**Cost per kWh** = local electricity cost (in \$/kWh)

Note that the local utility cost should be the cost per kilowatt hour based on your last monthly purchase. Most utility billing structures are such that the more energy you purchase, the less it costs per kilowatt hour.

#### SAMPLE CALCULATION

A Toronto resident is considering purchasing a central air conditioner. The utility rate for electricity is \$0.0826/kWh. From Table 1, Toronto has 347 cooling degree-days and a summer outdoor design temperature of 31°C. The rated capacity of the unit is 36 000 Btu/h with a rated SEER of 10.0.

Substituting the values into the equation yields

$$\begin{aligned}\text{Cost of operation} &= \frac{24 \times 359}{(30 - 18)} \times \frac{36\,000}{10} \times \frac{0.0826}{1000} \\ &= \text{\$214/year}\end{aligned}$$

The resident is also considering another unit with identical capacity but with a SEER of 12.0. This unit sells for \$250 more. To compare the two units, perform the same calculation, substituting 12.0 for the SEER.

$$\begin{aligned}\text{Cost of operation} &= \frac{24 \times 359}{30 - 18} \times \frac{36\,000}{12} \times \frac{0.0826}{1000} \\ &= \mathbf{\$178/\text{year}}\end{aligned}$$

The savings are about \$36 per year. This represents a simple payback period of about seven years.

Remember that the more efficient model may also have a lower sound rating, and while there is no payback for noise reduction, it can be important to you and your neighbours.



**Table 1. Cooling Degree-Days and Summer Outdoor Design Temperature**

| PROVINCE/CITY                    | DD <sub>C-18</sub> | T <sub>OD</sub> (°C) |
|----------------------------------|--------------------|----------------------|
| <b>British Columbia</b>          |                    |                      |
| Kamloops                         | 261                | 34                   |
| Penticton                        | 213                | 32                   |
| Prince George                    | 22                 | 27                   |
| Vancouver                        | 44                 | 25                   |
| Victoria                         | 24                 | 26                   |
| <b>Alberta</b>                   |                    |                      |
| Calgary                          | 40                 | 29                   |
| Edmonton                         | 28                 | 28                   |
| Lethbridge                       | 108                | 31                   |
| Medicine Hat                     | 187                | 32                   |
| <b>Saskatchewan</b>              |                    |                      |
| Moose Jaw                        | 177                | 32                   |
| Regina                           | 146                | 32                   |
| Saskatoon                        | 117                | 31                   |
| <b>Manitoba</b>                  |                    |                      |
| Brandon                          | 119                | 31                   |
| Winnipeg                         | 186                | 31                   |
| <b>Ontario</b>                   |                    |                      |
| London                           | 236                | 30                   |
| North Bay                        | 119                | 27                   |
| Ottawa                           | 245                | 30                   |
| Sudbury                          | 138                | 29                   |
| Thunder Bay                      | 70                 | 29                   |
| Toronto                          | 359                | 30                   |
| Windsor                          | 422                | 31                   |
| <b>Quebec</b>                    |                    |                      |
| Montréal                         | 236                | 30                   |
| Québec                           | 133                | 29                   |
| Sept-Îles                        | 9                  | 22                   |
| Sherbrooke                       | 101                | 29                   |
| <b>New Brunswick</b>             |                    |                      |
| Fredericton                      | 143                | 30                   |
| Moncton                          | 103                | 28                   |
| Saint John                       | 37                 | 26                   |
| <b>Nova Scotia</b>               |                    |                      |
| Halifax                          | 104                | 27                   |
| Sydney                           | 84                 | 27                   |
| <b>Prince Edward Island</b>      |                    |                      |
| Charlottetown                    | 100                | 26                   |
| Summerside                       | 112                | 26                   |
| <b>Newfoundland and Labrador</b> |                    |                      |
| Gander                           | 43                 | 26                   |
| St. John's                       | 32                 | 24                   |

Sources: Environment Canada, ASHRAE

## ANSWERS TO SOME COMMONLY ASKED QUESTIONS

---

*When is the best time to buy an air conditioner?*

Like many other things, the best time to buy is during the off-season. Contractors will have more time to spend with you to consider your particular needs and to help determine exactly what system is most suitable.

*How can I select a good contractor from whom to purchase a central air conditioner?*

Selecting a reputable contractor is a key consideration in the decision to buy a central air-conditioning system. The following tips should help you choose:

- Ensure that the contractor is qualified to install and maintain the equipment.
- The contractor should calculate the cooling load for the house and be prepared to explain this to you.
- The contractor should ensure that the ductwork system is designed to provide adequate airflow and distribution to all areas of the house. When the existing fan and ductwork are used, they should be examined to see if they are adequate, since an air-conditioning system may require greater airflow than the system was designed to handle.
- The contractor should ensure that the electrical system can accommodate the increased load of the air conditioner.
- The contractor should be willing to provide you with information on the unit and its SEER rating, operation and warranty, and to offer a service contract on the installation. The contractor should be prepared to guarantee the installation work.

In addition, follow the usual process for selecting a contractor: ask friends and relatives for referrals; get firm (written) quotes from at least two contractors; check with previous clients to see if they were satisfied with the equipment, installation and service provided; and follow up with the Better Business Bureau to find out if there are any outstanding claims against the contractor. If you know which brand of air conditioner you want to have installed, the manufacturer may recommend a contractor in your area.

*Are there any municipal by-laws that affect the use of air conditioners?*

Some municipalities have enacted by-laws that limit the permissible noise level from such equipment. Generally, maximum noise levels are specified at the lot line. Check with your local municipal office to find out if such by-laws are in effect or if there are any additional requirements you will need to satisfy.

*Should I replace both my outdoor condensing unit (which includes the compressor) and the indoor coil on my central air conditioning system at the same time?*

Yes, under most circumstances. The indoor and outdoor components of central air conditioners are intended to operate together, and the rated SEER is based on tests of these components working together. Matching a new high-SEER condensing unit with an old indoor coil would result in an unknown SEER and probably suboptimum efficiency.

*If I am buying a house, how can I make sure that the air-conditioning system is in good working order?*

You can check the system yourself. Turn the system on and listen for unusual sounds. Feel how cool the air is and how much airflow is coming from the vents. Listen to the indoor and outdoor sections of the system. Within a few minutes of start-up, air from the vents should be considerably cooler than the rest of the air in the house.

Although this personal inspection will provide a good indication of normal operation, the best way is to hire an air-conditioning contractor to inspect the system.

*Should I let the air conditioner fan run all the time (the “on” setting on the thermostat) or only periodically (the “auto” setting on the thermostat)?*

Fans require a significant amount of electrical energy to operate. For indoor fans, this energy ends up in the form of heat inside the house, thus adding to the cooling requirement that the air conditioner must meet. So in addition to paying to operate the fan, you will have to pay to remove its heat. The SEER rating for your system was determined assuming “auto” fan operation. Continuous fan operation also reduces dehumidification. For these reasons, fan operation should be restricted to those times when it is providing some tangible benefit.

Sometimes comfort will improve with continuous fan operation by providing a more uniform temperature throughout the house. Air movement also tends to make the body feel comfortable at higher temperatures, possibly allowing you to adjust the thermostat to a higher setpoint.

*Is there any relationship between my home air-conditioning system and chlorofluorocarbon (CFC) refrigerant damage to the ozone layer?*

Both central air conditioners and room air conditioners utilize hydrochlorofluorocarbon (HCFC-22) as a refrigerant. HCFC-22 is not as damaging to the ozone layer as CFCs. HCFC-22 does have some ozone-depletion potential, but it is only 5 percent of that of CFCs, since the molecule breaks down fairly rapidly if released into the lower atmosphere.

In some provinces and territories, it is illegal to release HCFCs into the atmosphere; soon, this will be the case nationally. Only deal with service companies that practise refrigerant recovery and recycling and have the proper equipment and training to do so. Your air conditioner is designed to operate as a closed system and will not release refrigerant as long as it is properly maintained. Have your system checked for leaks and serviced once a year, before the cooling season.

*Are there air conditioners other than window room air conditioners for homes without ductwork?*

Several air-conditioning system options are available to meet this requirement.

- Intended for permanent installation, multi-split systems include up to three indoor evaporator units connected to a single outdoor condenser section. This permits three separate areas or zones to be cooled independently. It is easier to retrofit the interconnecting refrigerant lines and control wiring than to install an air distribution system.
- One type of portable room air conditioner is not intended for window (or wall) installation. Instead, it sits on the floor and may be rolled on its casters into whichever room it is needed. Some of these portables reject condenser heat into a tank of water contained within the cabinet, which must be periodically replenished with cold water.
- Certain central air-conditioning systems are specifically designed for houses without air distribution systems. These systems utilize small-diameter air ducts that lend themselves to retrofit installation in walls, ceilings and floors. The small ducts require a special high-pressure air distribution fan to overcome their large pressure drop.

# ANNEX A. CAPACITY ESTIMATION PROCEDURE<sup>1</sup> FOR ROOM AIR CONDITIONERS

This procedure estimates the heat gain from a variety of sources. For each component, enter a quantity that you have measured or determined for your house, and multiply it by a factor that is provided. *If the air conditioner will only be used at night, use the factor in parentheses.*

## 1. Doors and arches

If the room has a permanently open door or archway more than 1.5 metres wide, skip this step and treat the two rooms as one, making all the necessary measurements in both rooms. Otherwise, record the width of the door or archway in metres and multiply by the factor provided.

$$\left[ \quad \quad \quad \right] \times \begin{array}{l} 980 \\ (660) \end{array} = \underline{\hspace{2cm}}$$

Total Width (m)

## 2. Windows

Calculate the area (length x width) of each window by measuring its height and width in centimetres, multiplying these together and dividing by 10 000 to give the area in square metres. Record the area for each window separately for use in step 6. Add the areas together and multiply by the factor that applies to your type of windows.

Triple-glass       $\left[ \quad \quad \quad \right] \times 50 = \underline{\hspace{2cm}}$   
Window Area (m<sup>2</sup>)

Double-glass       $\left[ \quad \quad \quad \right] \times 75 = \underline{\hspace{2cm}}$   
or glass block    Window Area (m<sup>2</sup>)

Single-glass       $\left[ \quad \quad \quad \right] \times 150 = \underline{\hspace{2cm}}$   
Window Area (m<sup>2</sup>)

<sup>1</sup> Adapted from the cost estimation procedure published by the Association of Home Appliance Manufacturers.

### 3. Walls

Measure the length of all walls in metres. Walls shaded by other buildings are considered to be facing north. Record the length in the box that applies to each of your walls and multiply by the corresponding factor(s).

Inside walls (to unconditioned space)

$$\left[ \quad \quad \quad \right] \times 100 = \underline{\hspace{2cm}}$$

Wall Length (m)

#### Light construction

Outside wall facing north

$$\left[ \quad \quad \quad \right] \times 100 = \underline{\hspace{2cm}}$$

Wall Length (m) (66)

Other outside walls

$$\left[ \quad \quad \quad \right] \times 200 = \underline{\hspace{2cm}}$$

Wall Length (m) (66)

#### Heavy construction

Outside wall facing north

$$\left[ \quad \quad \quad \right] \times 66 = \underline{\hspace{2cm}}$$

Wall Length (m)

Other outside walls

$$\left[ \quad \quad \quad \right] \times 100 = \underline{\hspace{2cm}}$$

Wall Length (m) (66)

### 4. Ceiling

Calculate the ceiling area (length x width) in square metres. Record the value in the box that applies to your ceiling and multiply by the corresponding factors.

Occupied, space above  $\left[ \quad \quad \quad \right] \times 32 =$   
Ceiling Area (m<sup>2</sup>)

Insulated, attic above  $\left[ \quad \quad \quad \right] \times 54 = \underline{\hspace{2cm}}$   
Ceiling Area (m<sup>2</sup>) (43)

Insulated, no attic  $\left[ \quad \quad \quad \right] \times 86 = \underline{\hspace{2cm}}$   
Ceiling Area (m<sup>2</sup>) (32)

Uninsulated, attic above  $\left[ \quad \quad \quad \right] \times 130 = \underline{\hspace{2cm}}$   
Ceiling Area (m<sup>2</sup>) (75)

Uninsulated, no attic  $\left[ \quad \quad \quad \right] \times 200 = \underline{\hspace{2cm}}$   
Ceiling Area (m<sup>2</sup>) (54)

## 5. Floor

If the floor is on the ground or over a basement, skip this step. Otherwise, calculate the floor area (length x width) in square metres. Record the value in the box and multiply by the factor provided.

$$\left[ \quad \quad \quad \right] \times 32 = \underline{\hspace{2cm}}$$

Floor Area (m<sup>2</sup>)

## 6. Solar heat gain

If all of the windows face north or if the air conditioner will be used only at night, skip this step. Otherwise, using the areas measured for each window in step 2, record the total window area for each orientation that applies to your windows in the appropriate box, and multiply by the factor for the shading type that best represents your house conditions. Multiply this value by the factor that represents your window type. Once numbers are calculated for each orientation, compare them and select the largest one for use in step 7.

**No    Inside    Awnings    Window**  
**Shades   Shades                    Type\***

Northeast  $\left[ \quad \quad \quad \right] \times 650$  or  $\times 270$  or  $\times 215 \times \underline{\hspace{1cm}} = \underline{\hspace{1cm}}$   
Total Area (m<sup>2</sup>)

East  $\left[ \quad \quad \quad \right] \times 860$  or  $\times 430$  or  $\times 270 \times \underline{\hspace{1cm}} = \underline{\hspace{1cm}}$   
Total Area (m<sup>2</sup>)

Southeast  $\left[ \quad \quad \quad \right] \times 810$  or  $\times 320$  or  $\times 215 \times \underline{\hspace{1cm}} = \underline{\hspace{1cm}}$   
Total Area (m<sup>2</sup>)

South  $\left[ \quad \quad \quad \right] \times 810$  or  $\times 380$  or  $\times 215 \times \underline{\hspace{1cm}} = \underline{\hspace{1cm}}$   
Total Area (m<sup>2</sup>)

Southwest  $\left[ \quad \quad \quad \right] \times 1180$  or  $\times 480$  or  $\times 320 \times \underline{\hspace{1cm}} = \underline{\hspace{1cm}}$   
Total Area (m<sup>2</sup>)

West  $\left[ \quad \quad \quad \right] \times 1610$  or  $\times 700$  or  $\times 480 \times \underline{\hspace{1cm}} = \underline{\hspace{1cm}}$   
Total Area (m<sup>2</sup>)

Northwest  $\left[ \quad \quad \quad \right] \times 1290$  or  $\times 540$  or  $\times 375 \times \underline{\hspace{1cm}} = \underline{\hspace{1cm}}$   
Total Area (m<sup>2</sup>)

\*glass block: multiply by 0.5  
triple-glass: multiply by 0.7  
double-glass: multiply by 0.8  
single-glass: multiply by 1.0



## 7. Subtotal

Add the figures from steps 1 through 5 and the largest value calculated in step 6, and record the sum here.

\_\_\_\_\_

## 8. Climate correction

Enter the subtotal from step 7 in the box, find the climate correction factor for your area in Table A-1 and multiply the two together.

$$\left[ \quad \quad \quad \right] \times \frac{\quad \quad \quad}{\text{Climate Factor}} = \quad \quad \quad$$

## 9. Heat from people

Record the number of people who normally use the room (minimum of 2) and multiply by the factor provided.

$$\left[ \quad \quad \quad \right] \times 600 = \quad \quad \quad$$

Number of People

## 10. Heat from appliances

Record the sum of the wattages of all lights and appliances (used during air conditioner operation) in the room and multiply by the factor provided.

$$\left[ \quad \quad \quad \right] \times 3 = \quad \quad \quad$$

Total Watts

## 11. Total cooling load

Add the figures from steps 8, 9 and 10 to determine the total cooling load. This number is the maximum amount of heat that builds up in a room in an hour, in British thermal units per hour. When selecting your air conditioner, choose a unit with a capacity rating close to the estimated load. Remember that a smaller capacity unit operating continuously will result in greater comfort than a larger capacity unit operating intermittently.

**Table A-1. Climate Correction Factors**

|                         |      |                                      |      |
|-------------------------|------|--------------------------------------|------|
| <b>British Columbia</b> |      | <b>Quebec</b>                        |      |
| Kamloops                | 0.93 | Chicoutimi                           | 0.74 |
| Prince George           | 0.69 | Hull                                 | 0.84 |
| Trail                   | 0.90 | Montréal                             | 0.80 |
| Vancouver               | 0.52 | Québec                               | 0.80 |
| Victoria                | 0.46 | Rimouski                             | 0.64 |
|                         |      | Sept-Îles                            | 0.42 |
|                         |      | Val-d'Or                             | 0.69 |
| <b>Alberta</b>          |      | <b>New Brunswick</b>                 |      |
| Calgary                 | 0.69 | Edmundston                           | 0.76 |
| Edmonton                | 0.69 | Fredericton                          | 0.82 |
| Fort McMurray           | 0.74 | Moncton                              | 0.64 |
| Jasper                  | 0.63 | Saint John                           | 0.52 |
| Lethbridge              | 0.84 |                                      |      |
| Medicine Hat            | 0.97 |                                      |      |
| <b>Saskatchewan</b>     |      | <b>Nova Scotia</b>                   |      |
| Estevan                 | 0.90 | Amherst                              | 0.64 |
| Prince Albert           | 0.80 | Halifax                              | 0.46 |
| Regina                  | 0.90 | New Glasgow                          | 0.52 |
| Saskatoon               | 0.84 | Sydney                               | 0.58 |
| Swift Current           | 0.97 |                                      |      |
| <b>Manitoba</b>         |      | <b>Prince Edward Island</b>          |      |
| Brandon                 | 0.84 | Charlottetown                        | 0.52 |
| Churchill               | 0.58 | Summerside                           | 0.52 |
| Dauphin                 | 0.80 |                                      |      |
| Flin Flon               | 0.69 | <b>Newfoundland and<br/>Labrador</b> |      |
| Winnipeg                | 0.84 | Corner Brook                         | 0.42 |
|                         |      | Gander                               | 0.58 |
|                         |      | Goose Bay                            | 0.64 |
|                         |      | St. John's                           | 0.46 |
| <b>Ontario</b>          |      | <b>Territories</b>                   |      |
| Kapuskasing             | 0.74 | Inuvik                               | 0.52 |
| Kenora                  | 0.69 | Whitehorse                           | 0.58 |
| Ottawa                  | 0.84 | Yellowknife                          | 0.52 |
| St. Catharines          | 0.80 |                                      |      |
| Sudbury                 | 0.74 |                                      |      |
| Thunder Bay             | 0.69 |                                      |      |
| Toronto                 | 0.84 |                                      |      |
| Windsor                 | 0.84 |                                      |      |

## NEED MORE INFORMATION?

---

### Check out our free publications

Natural Resources Canada's (NRCan's) Office of Energy Efficiency (OEE) has many *free* publications that will help you understand home heating systems, home energy use and transportation efficiency. These publications explain what you can do to reduce your energy and maintenance costs while increasing your comfort and helping the environment.

### Want to draftproof and reduce your energy use?

*Keeping the Heat In* is a guide to all aspects of home insulation and draftproofing. Whether you plan to do it yourself or hire a contractor, this 134-page book (also available in CD format) can help make it easier.

### How about home heating, cooling and ventilation systems?

If you are interested in a particular energy source, NRCan has booklets on heating with electricity, gas, oil, heat pumps and wood. Other publications are available on heat recovery ventilators, wood fireplaces, gas fireplaces, air conditioning your home and comparing heating costs.

### ... and consumer's guides?

The Consumer's Guides can help you choose energy-efficient items, such as household appliances, lighting products, office equipment, windows and doors, and a resale home.

### ... and EnerGuide directories?

EnerGuide is designed to help you choose energy-using products that use the least amount of energy. The EnerGuide label, which is affixed to major electrical household appliances and room air conditioners, helps you choose the most

energy-efficient models. Annual directories list the EnerGuide ratings of major electrical household appliances and room air conditioners.

### **... and energy-efficient new housing?**

R-2000\* homes use up to 50 percent less energy than conventional dwellings. Features include state-of-the-art heating systems, high levels of insulation, use of solar energy, and whole-house ventilation systems that provide continuous fresh air to all rooms. Once completed, R-2000 homes are subject to third-party testing. Call or write for further details on this Canadian technology.

### **... and transportation efficiency?**

*The AutoSmart Guide* shows you how to buy, drive and maintain your car to save money and energy. The *Car Economy Calculator* helps you determine your vehicle's fuel consumption. The annual *Fuel Consumption Guide* lists the fuel consumption ratings of most new vehicles sold in Canada. Information is also available on fuel alternatives to gasoline and diesel, such as propane, natural gas, ethanol and methanol fuels.

**To receive any of the *free* publications listed above, please contact**

Energy Publications  
Office of Energy Efficiency  
Natural Resources Canada  
c/o S.J.D.S.  
Gatineau Qc J9J 3N7

Tel.: 1 800 387-2000 (toll-free)

Fax: (819) 779-2833

In the National Capital Region, call 995-2943.

TTY: (613) 996-4397 (teletype for the hearing-impaired)

You can also view or order publications on-line from the OEE Web site at [oee.nrcan.gc.ca/infosource](http://oee.nrcan.gc.ca/infosource).

*Please allow three weeks for delivery.*

\*R-2000 is an official mark of Natural Resources Canada.



---

The One-Tonne Challenge asks Canadians to reduce their annual greenhouse gas emissions by 20% or about one tonne.



*Leading Canadians to Energy Efficiency at Home, at Work and on the Road*

The Office of Energy Efficiency of Natural Resources Canada strengthens and expands Canada's commitment to energy efficiency in order to help address the challenges of climate change.

Canada