

**Manitoba Industry, Economic Development and Mines  
Petroleum Branch**

**Designated Fields  
and Pools  
2006**

## **FOREWORD**

This order does not include previously designated fields and pools that have been amalgamated or reassigned. Information pertaining to the history of field or pool designations may be obtained by contacting the Petroleum Branch.

The Petroleum Branch is committed to providing quality service to all its clients. If you have any comments or suggestions related to the content quality or relevance of information received from the Branch, or service provided by Branch staff, please contact:

Carol Martiniuk, Acting Director  
Petroleum Branch  
Manitoba Industry, Economic Development And Mines  
1395 Ellice Avenue, Suite 360  
Winnipeg MB R3G 3P2  
Phone: (204) 945-6570  
Fax: (204) 945-0586

Effective **January 1, 2006**, the following Fields are designated under clause 11(4)(b) of The Oil and Gas Act. The area encompassed by each Field is outlined on the referenced plat listed on pages 4 to 10.

---

Carol Martiniuk, Acting Director

<b>FIELD</b>	<b>CODE</b>	<b>PLAT</b>
Daly Field	01	p. 4
Tilston Field	02	p. 4
Waskada Field	03	p. 5
Lulu Lake Field	04	p. 5
Virден Field	05	p. 6
Whitewater Field	06	p. 6
Pierson Field	07	p. 7
Kirkella Field	09	p. 7
Souris Hartney Field	10	p. 8
Coulter Field	11	p. 8
Regent Field	13	p. 9
Mountainside Field	14	p. 9
Birdtail Field	15	p. 10
Sinclair Field	16	p. 10

**MANITOBA DESIGNATED FIELDS  
( FIELD PLATS )**

Rge 29 WPM												Rge 28 WPM					Rge 27 WPM				
7	8	9	10	11	12	7	8	9	10	11	12	7	8	9	10	11	12				
6	5	4	3	2	1	6	5	4	3	2	1	6	5	4	3	2	1				
31	32	33	34	35	36	31	32	33	34	35	36	31	32	33	34	35	36				
30	29	28	27	26	25	30	29	28	27	26	25	30	29	28	27	26	25				
19	20	21	22	23	24	19	20	21	22	23	24	19	20	21	22	23	24				
18	17	16	15	14	13	18	17	16	15	14	13	18	17	16	15	14	13				
7	8	9	10	11	12	7	8	9	10	11	12	7	8	9	10	11	12				
6	5	4	3	2	1	6	5	4	3	2	1	6	5	4	3	2	1				
31	32	33	34	35	36	31	32	33	34	35	36	31	32	33	34	35	36				
30	29	28	27	26	25	30	29	28	27	26	25	30	29	28	27	26	25				
19	20	21	22	23	24	19	20	21	22	23	24	19	20	21	22	23	24				
18	17	16	15	14	13	18	17	16	15	14	13	18	17	16	15	14	13				
7	8	9	10	11	12	7	8	9	10	11	12	7	8	9	10	11	12				
6	5	4	3	2	1	6	5	4	3	2	1	6	5	4	3	2	1				
31	32	33	34	35	36	31	32	33	34	35	36	31	32	33	34	35	36				
30	29	28	27	26	25	30	29	28	27	26	25	30	29	28	27	26	25				
19	20	21	22	23	24	19	20	21	22	23	24	19	20	21	22	23	24				
18	17	16	15	14	13	18	17	16	15	14	13	18	17	16	15	14	13				
7	8	9	10	11	12	7	8	9	10	11	12	7	8	9	10	11	12				
6	5	4	3	2	1	6	5	4	3	2	1	6	5	4	3	2	1				

**DALY FIELD**

Twp 10

Twp 9

Twp 8

Rge 29 WPM					
30	29	28	27	26	25
19	20	21	22	23	24
18	17	16	15	14	13
7	8	9	10	11	12
6	5	4	3	2	1
31	32	33	34	35	36
30	29	28	27	26	25
19	20	21	22	23	24
18	17	16	15	14	13

Twp 6

Twp 5

**TILSTON FIELD**

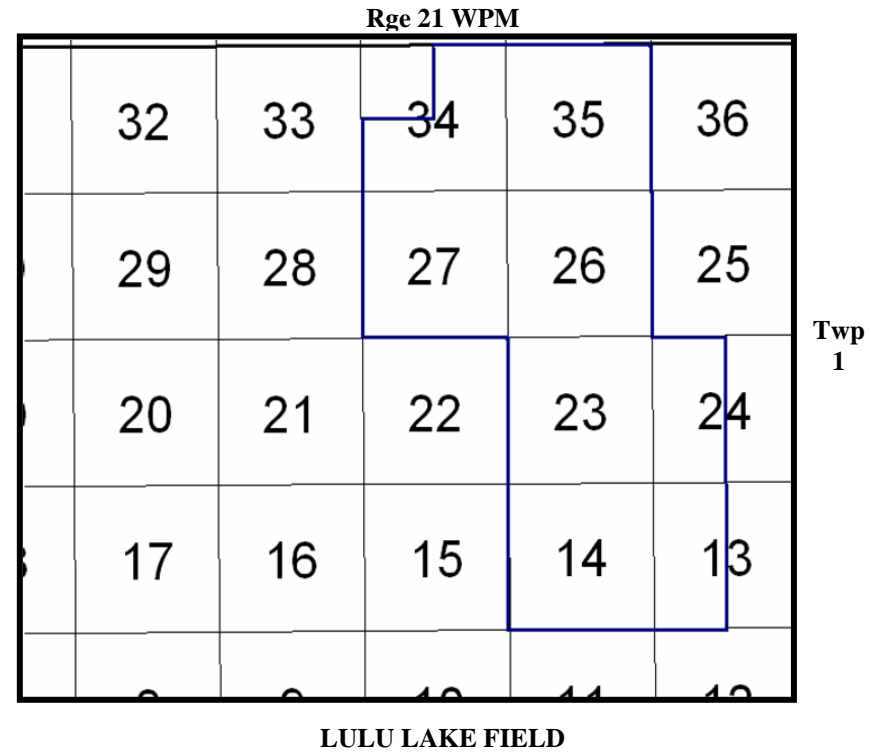
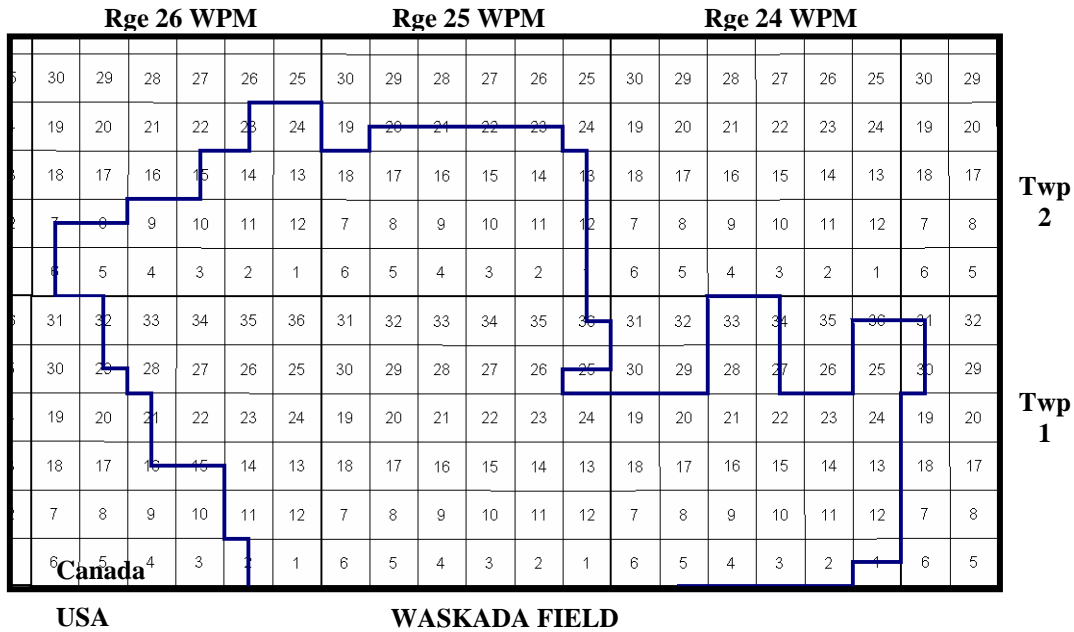

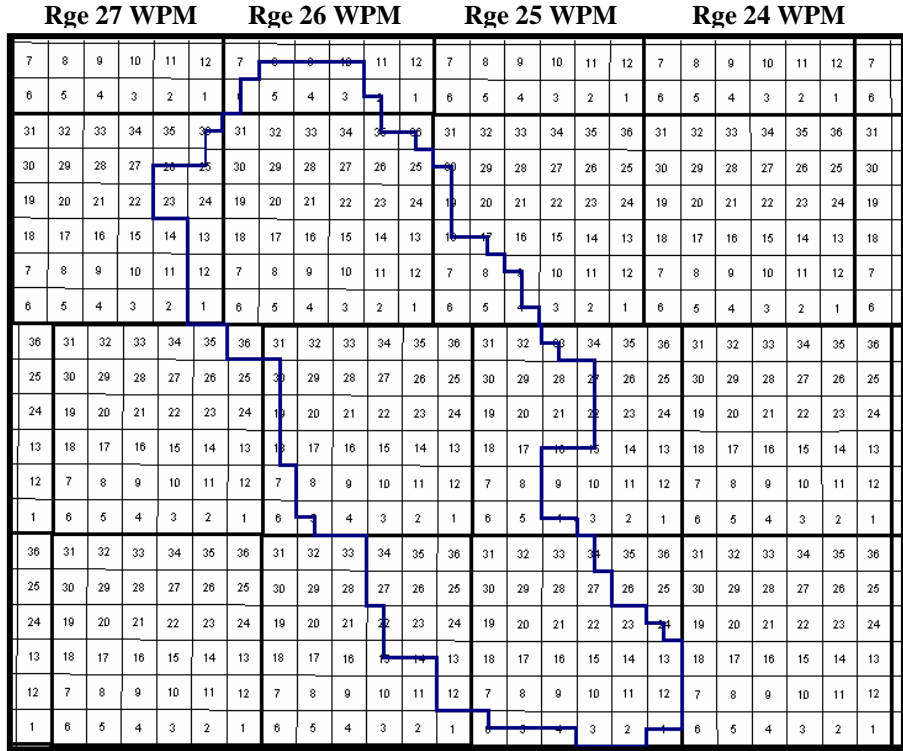

**VIRDEN FIELD**

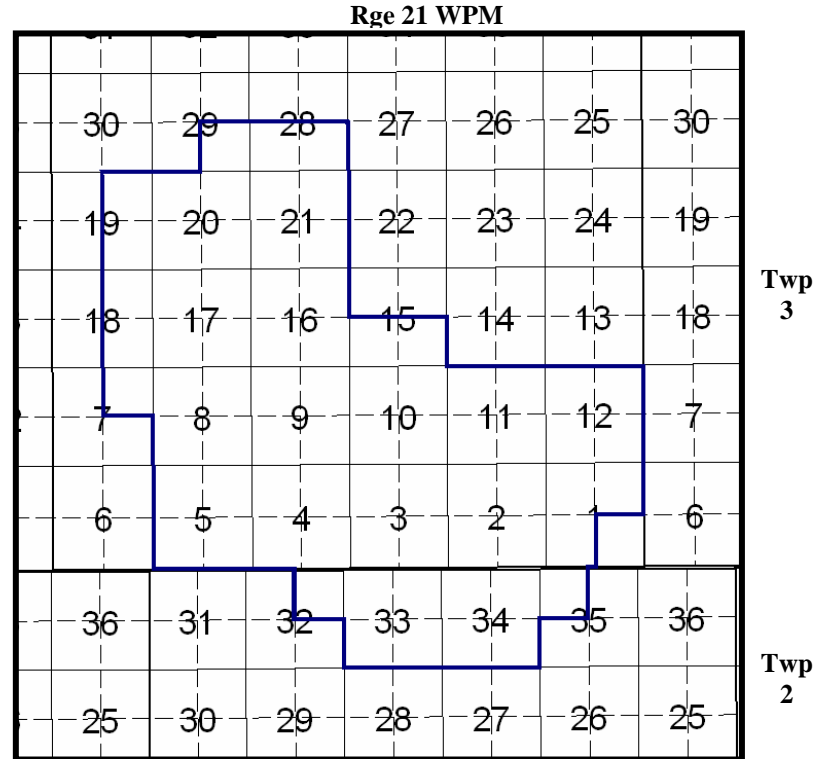

**WHITEWATER FIELD**





Rge 22 WPM

30	29	28	27	26	25
19	20	21	22	23	24
18	17	16	15	14	13
7	8	9	10	11	12
6	5	4	3	2	1

SOURIS HARTNEY FIELD

Twp  
6

Rge 28 WPM

11	12	7	8	9	10	11	12
2	1	6	5	4	3	2	1
35	36	31	32	33	34	35	36
26	25	30	29	28	27	26	25
23	24	19	20	21	22	23	24
14	13	18	17	16	15	14	13
11	12	7	8	9	10	11	12

Rge 27 WPM

Twp  
2

Twp  
1

COULTER FIELD

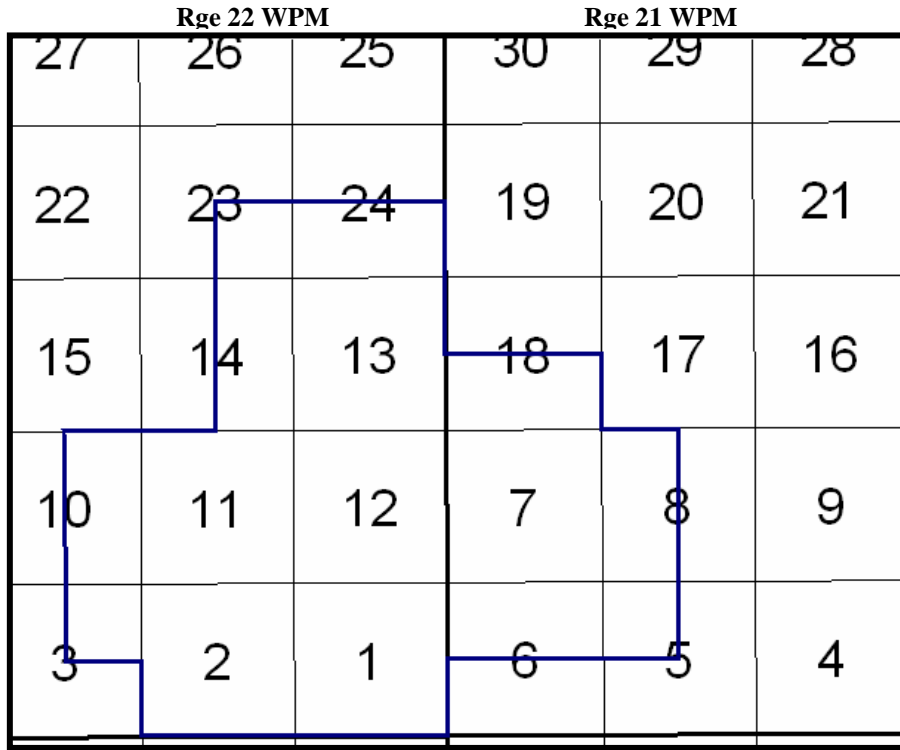

Twp  
4

**REGENT FIELD**

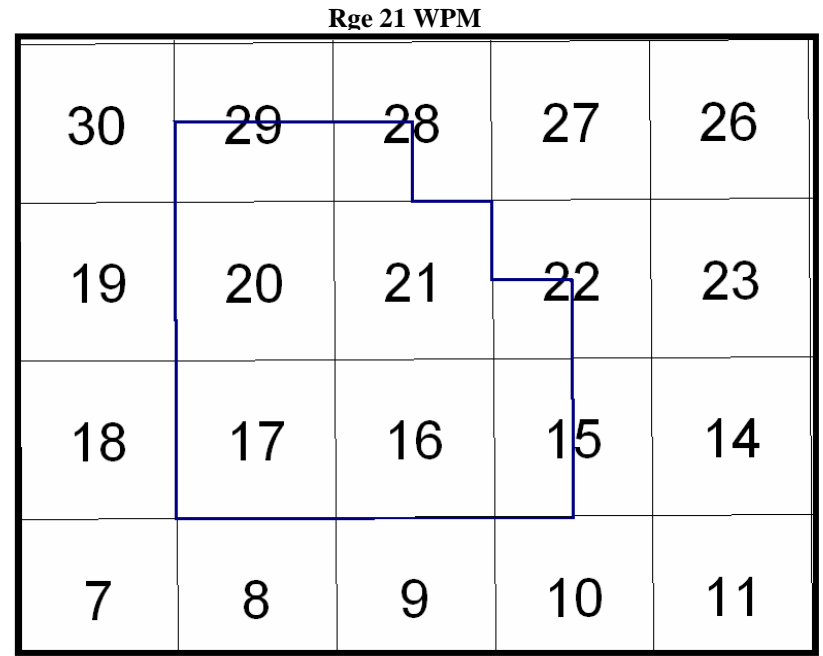

Twp  
2

**MOUNTAINSIDE FIELD**

Rge 28 WPM

Rge 27 WPM

25	30	29	28	27	26	25
24	19	20	21	22	23	24
13	18	17	16	15	14	13
12	7	8	9	10	11	12
1	6	5	4	3	2	1
36	31	32	33	34	35	36
25	30	29	28	27	26	25

BIRDTAIL FIELD

Twp 16

Twp 15

Rge 29 WPM

Rge 28 WPM

31	30	29	28	27	26	36	31	32	33	34
30	29	28	27	26	25	25	30	29	28	27
19	20	21	22	23	24	24	19	20	21	22
18	17	16	15	14	13	13	18	17	16	15
7	8	9	10	11	12	12	7	8	9	10
6	5	4	3	2	1	1	6	5	4	3
31	32	33	34	35	36	36	31	32	33	34
30	29	28	27	26	25	25	30	29	28	27
19	20	21	22	23	24	24	19	20	21	22
18	17	16	15	14	13	13	18	17	16	15
7	8	9	10	11	12	12	7	8	9	10
6	5	4	3	2	1	1	6	5	4	3
31	32	33	34	35	36	36	31	32	33	34

Twp 8

Twp 7

Twp 6

SINCLAIR FIELD

Effective **January 1, 2006**, the following Pools are designated under clause 11(4)(a) of the Oil and Gas Act. The area encompassed by each Pool and stratigraphic interval is described herein, or outlined on the referenced plats listed on pages 22 to 63.

---

Carol Martiniuk, Acting Director

**MANITOBA DESIGNATED POOLS**

POOL	CODE	AREA OF COVERAGE		REFERENCE WELL	
		Plat	Legal Description (Lsd-Sec-Twp-Rge)	UWI	Interval (m KB)
<b><u>Daly Field</u></b>					
Lodgepole A	01 59A	p. 22	-	100/14-04-010-28W1/00	725.4-821.4
Lodgepole B	01 59B	p. 22	-	100/13-14-009-28W1/00	736.4-832.7
Lodgepole C	01 59C	p. 23	-	100/03-33-008-27W1/00	736.7-837.0
Lodgepole D	01 59D	p. 23	-	100/07-26-009-29W1/00	783.3-883.3
Lodgepole E	01 59E	p. 24	-	100/13-21-010-28W1/00	718.5-802.2
Lodgepole F	01 59F	p. 24	-	100/03-31-009-29W1/00	819.0-913.0
Lodgepole I	01 59I	p. 25	-	100/05-07-010-29W1/00	822.0-865.0
Lodgepole K	01 59K	-	Lsd 8-30-10-29	100/08-30-010-29W1/00	788.0-877.5
Lodgepole M	01 59M	-	Lsd 6-15-8-28	100/06-15-008-28W1/00	778.0-888.0
Lodgepole N	01 59N	-	Lsd 15-17-8-28	100/15-17-008-28W1/00	793.0-903.0
Lodgepole O	01 59O	p. 25	-	100/11-22-008-28W1/00	759.0-870.5
Lodgepole P	01 59P	-	Lsd 3-27-10-29	100/03-27-010-29W1/00	769.0-853.2
Lodgepole Q	01 59Q	p. 26	-	100/06-33-008-28W1/00	769.0-872.0
Lodgepole R	01 59R	-	Lsd 12-5-9-29	100/12-05-009-29W1/00	839.0-951.0
Lodgepole S	01 59S	-	Lsd's 14 & 15-12-9-29 & Lsd's 2 & 3-13-9-29	100/15-12-009-29W1/00	793.0-900.0
Lodgepole T	01 59T	-	Lsd's 1,2,7,8, 9 & 10-17-10-29	100/08-17-010-29W1/00	808.0-813.0
Bakken A	01 60A	p. 26	-	100/13-21-010-29W1/00	875.0-881.0
Bakken B	01 60B	p. 27	-	100/10-29-010-28W1/00	811.5-817.0
Bakken E	01 60E	-	Lsd 12-5-09-29	100/12-05-009-29W1/02	953.7-959.5
Bakken G	01 60G	-	Lsd 13-6-9-27	100/13-06-009-27W1/00	828.0-832.0
Bakken I	01 60I	p. 27	-	100/02-23-009-28W1/02	829.8-834.7
Bakken J	01 60J	-	Lsd's 7, 8, 9 & 10-18-10-27	100/07-18-010-27W1/02	780.3-784.6
Bakken L	01 60L	-	Lsd 16-10-10-28	100/16-10-010-28W1/02	809.5-813.0
Bakken M	01 60M	-	Lsd's 5,6,7,10 & 15-2-10-29	100/15-02-010-29W1/02	865.0-869.2

POOL	CODE	AREA OF COVERAGE		REFERENCE WELL	
		Plat	Legal Description (Lsd-Sec-Twp-Rge)	UWI	Interval (m KB)
Bakken N	01 60N	p. 28	-	100/14-24-009-29W1/02	776.5-881.0
Bakken P	01 60P	p. 28	-	100/12-28-009-28W1/02	842.7-845.7
Bakken Q	01 60Q	p. 29	-	100/03-27-009-28W1/02	746.0-748.0
Bakken R	01 60R	-	Lsd 3-13-9-29	100/03-13-009-29W1/02	903.5-906.5
Bakken U	01 60U	-	Lsd 2-19-9-29	100/02-19-009-29W1/02	934.5-942.5
Bakken V	01 60V	-	Lsd 16-30-9-28	102/16-30-009-28W1/02	860.8-862.3
Bakken X	01 60X	-	Lsd's 5, 6 & 7-16-10-28	100/05-16-010-28W1/02	824.5-826.0
Bakken Z	01 60Z	p. 29	-	100/08-07-010-28W1/02	833.0-836.0
Bakken BB	01 60BB	p. 30	-	100/04-08-010-29W1/02	887.4-890.5
Bakken DD	01 60DD	p. 30	-	100/15-33-009-28W1/02	828.4-830.4
Bakken-Three Forks A	01 62A	p. 31	-	100/01-22-010-29W1/00	859.5-866.0
Bakken-Three Forks B	01 62B	p. 31	-	100/04-21-009-29W1/02	917.0-927.0
Bakken-Three Forks D	01 62D	-	Lsd 7-18-10-29	100/07-18-010-29W1/02	888.0-896.0
Bakken-Three Forks E	01 62E	-	Lsd 9, 16-8-8-28 & 12&13-9-8-28	100/16-08-008-28W1/00	918.0-920.0
Bakken-Three Forks F	01 62F	-	Lsd 15-32-9-29	100/15-32-009-29W1/00	905.0-908.0
<b><u>Tilston Field</u></b>					
Mission Canyon 1 A	02 44A	p. 32	-	100/06-31-005-29W1/00	940.0-969.0
Mission Canyon 1 C	02 44C	p. 32	-	100/02-08-006-29W1/00	925.0-940.0
Mission Canyon 1 D	02 44D	p. 33	-	100/11-15-006-29W1/00	907.0-910.5
<b><u>Waskada Field</u></b>					
Favel C	03 10C	-	Lsd 10-17-1-24	100/10-17-001-24W1/00	481.5-484.5
Lower Amaranth A	03 29A	p. 33	-	100/11-30-001-25W1/03	884.5-920.5
Lower Amaranth I	03 29I	p. 34	-	100/03-01-001-25W1/00	873.7-910.0

POOL	CODE	AREA OF COVERAGE		REFERENCE WELL	
		Plat	Legal Description (Lsd-Sec-Twp-Rge)	UWI	Interval (m KB)
Lower Amaranth J	03 29J	-	Lsd 1-3-01-25	100/01-03-001-25W1/00	885.0-920.5
Lower Amaranth K	03 29K	-	Lsd 3-24-1-25	100/03-24-001-25W1/02	866.0-898.0
Lower Amaranth L	03 29L	p. 34	-	100/10-04-001-25W1/00	890.2-923.4
Mission Canyon 3b A	03 42A	p. 35	-	100/11-30-001-25W1/03	920.5-929.6
Mission Canyon 3b B	03 42B	p. 35	-	100/13-27-001-26W1/00	920.0-936.5
Mission Canyon 3b C	03 42C	p. 36	-	100/05-07-001-25W1/00	931.5-941.0
Mission Canyon 3b E	03 42E	-	Lsd's 12 & 13-5-1-25 & Lsd's 9-6-1-25 & 4-8-1-25	100/04-08-001-25W1/00	936.0-948.0
Mission Canyon 3b F	03 42F	-	Lsd 11-22-1-26	100/11-22-001-26W1/02	929.5-948.0
Mission Canyon 3b G	03 42G	-	Lsd 11-5-2-26	100/11-05-002-26W1/00	929.0-955.5
Mission Canyon 3a A	03 43A	p. 36	-	100/01-25-001-26W1/00	928.0-950.0
Mission Canyon 3a B	03 43B	-	Lsd's 11,12,13 & 14-23-1-25	100/12-23-001-25W1/00	904.6-912.6
Mission Canyon 3a C	03 43C	p. 37	-	100/12-26-001-26W1/00	924.0-940.0
Mission Canyon 3a D	03 43D	-	Lsd's 10 & 11-30-1-25	100/10-30-001-25W1/00	921.0-931.0
Mission Canyon 3a E	03 43E	p. 37	-	100/02-12-001-26W1/02	930.0-944.0
Mission Canyon 3a F	03 43F	-	Lsd 15-5-1-25	100/15-05-001-25W1/00	931.0-941.0
Mission Canyon 3a G	03 43G	p. 38	-	100/12-31-001-25W1/00	912.5-929.0
Mission Canyon 3a H	03 43H	-	Lsd 6-18-2-25	100/06-18-002-25W1/00	899.0-907.0
Mission Canyon 3a I	03 43I	p. 38	-	100/07-35-001-26W1/00	917.0-935.0
Mission Canyon 3a K	03 43K	-	Lsd's 6, 11 & 14-19-1-25	100/06-19-001-25W1/00	924.0-934.0
Mission Canyon 3a L	03 43L	-	Lsd's 8 & 9-32-1-25	100/08-32-001-25W1/00	909.5-917.0
Mission Canyon 3a M	03 43M	-	Lsd 10-10-1-25	100/10-10-001-25W1/00	915.0-925.0
Mission Canyon 3a N	03 43N	-	Lsd 02-20-1-25	100/02-20-001-25W1/00	919.5-930.0
Mission Canyon 1 A	03 44A	-	Lsd's 8, 9 & 16-19-1-25 & Lsd's 1 & 8-30-1-25	100/01-30-001-25W1/00	917.4-947.9
Mission Canyon 1 B	03 44B	p. 39	-	100/09-13-001-26W1/00	920.5-967.4
Mission Canyon 1 C	03 44C	-	Lsd's 2,3,6 & 7-22-1-25	100/02-22-001-25W1/00	908.3-943.0

POOL	CODE	AREA OF COVERAGE		REFERENCE WELL	
		Plat	Legal Description (Lsd-Sec-Twp-Rge)	UWI	Interval (m KB)
Mission Canyon 1 D	03 44D	p. 39	-	100/04-09-002-25W1/00	986.0-912.0
Mission Canyon 1 E	03 44E	p. 40	-	100/06-33-001-25W1/00	905.5-942.0
Mission Canyon 1 F	03 44F	-	Lsd 2-27-1-25	100/02-27-001-25W1/00	902.5-930.0
Mission Canyon 1 G	03 44G	-	Lsd's 3, 4, 5 & 6-5-1-24	100/04-05-001-24W1/00	910.0-937.0
Mission Canyon 1 H	03 44H	-	Lsd 3-24-1-25	100/03-24-001-25W1/00	898.0-910.0
Mission Canyon 1 I	03 44I	-	Lsd's 2, 3, 4 & 5-14-2-25	100/02-14-002-25W1/00	882.0-915.0
Mission Canyon 1 I	03 44J	-	Lsd 4-24-2-26	100/04-24-002-26W1/00	898.0-900.0
Mission Canyon 1 K	03 44K	-	Lsd's 1, 2, 7 & 8-33-1-24	100/02-33-001-24W1/00	871.7-900.0
Mission Canyon 1 L	03 44L	-	Lsd 4-12-1-24	100/04-12-001-24W1/00	941.5-946.0
Mission Canyon 1 M	03 44M	-	Lsd's 9, 10, 15 & 16-25-1-24	100/09-25-001-24W1/00	939.5-941.5
Mission Canyon 1 N	03 44N	-	Lds 6-7-1-24	100/06-07-001-24W1/00	897.5-898.5

### **Lulu Lake Field**

Lodgepole WL A	04 52A	p. 40	-	100/08-23-001-21W1/00	1008.5-1027.0
Lodgepole WL B	04 52B	p. 41	-	100/15-27-001-21W1/00	1005.5-1024.0

### **Virден Field**

Lodgepole A	05 59A	p. 41	-	102/06-27-011-26W1/00	563.9-667.0
Lodgepole B	05 59B	p. 42	-	100/06-28-010-26W1/00	623.0-726.0
Lodgepole C	05 59C	p. 42	-	100/10-21-009-25W1/00	595.0-648.0
Lodgepole D	05 59D	p. 43	-	100/07-11-009-25W1/00	598.9-655.3
Lodgepole E	05 59E	p. 43	-	100/07-26-009-26W1/00	634.0-732.1
Lodgepole G	05 59G	-	Lsd 10-1-11-27	100/10-01-011-27W1/00	647.0-710.0
Lodgepole J	05 59J	-	Lsd 9 & 16-23-11-27, & Lsd 13 & 14-24-11-27	100/14-24-011-27W1/00	653.0-667.0

### **Whitewater Field**



POOL	CODE	AREA OF COVERAGE		REFERENCE WELL	
		Plat	Legal Description (Lsd-Sec-Twp-Rge)	UWI	Interval (m KB)
Lower Amaranth A	06 29A	p. 44	-	100/04-21-003-21W1/02	745.0-757.7
Lodgepole WL A	06 52A	p. 44	-	100/16-17-003-21W1/00	759.6-786.1
Lodgepole WL B	06 52B	p. 45	-	100/16-02-003-21W1/00	790.5-812.5
Lodgepole WL C	06 52C	p. 45	-	100/05-04-003-21W1/00	923.0-1856.0 md
Lodgepole Virden A	06 53A	p. 46	-	100/05-12-003-21W1/00	787.0-804.5
<b><u>Pierson Field</u></b>					
Lower Amaranth A	07 29A	-	Lsd 4-26-3-28	100/04-26-003-28W1/00	915.7-949.5
Lower Amaranth B	07 29B	p. 46	-	100/12-30-002-28W1/02	955.0-992.0
Lower Amaranth E	07 29E	-	Lsd 2, 3, 4, 7, 10-1-2-29	100/04-01-002-29W1/00	1016.0-1025.0
Lower Amaranth H	07 29H	-	Lsd 4-20-2-28	100/04-20-002-28W1/00	957.2-993.1
Lower Amaranth I	07 29I	p. 47	-	100/14-05-002-28W1/00	967.0-1007.0
Lower Amaranth J	07 29J	p. 47	-	100/13-26-001-28W1/00	956.5-993.0
Lower Amaranth L	07 29L	-	Lsd's 1, 2, 7 & 8-26-1-29	100/02-26-001-29W1/00	1000.0-1038.0
Lower Amaranth – Mission Canyon 3b A	07 35A	p. 48	-	100/14-17-002-29W1/02	997.0-1044.0
Lower Amaranth – Mission Canyon 3b B	07 35B	p. 48	-	100/01-35-002-28W1/00	959.0-963.0
Lower Amaranth – Mission Canyon 3b C	07 35C	-	Lsd's 3, 4, 5, 6, 11 & 12-34-2-28	100/04-34-002-28W1/00	975.4-976.0
Lower Amaranth – Mission Canyon 3b D	07 35D	-	Lsd 15-20-2-28	100/15-20-002-28W1/02	975.0-979.0
Mission Canyon 3 B	07 41B	-	Lsd 14-05-2-28	100/14-05-002-28W1/02	1007.5-1030.0
Mission Canyon 3 C	07 41C	p. 49	-	100/12-06-003-29W1/00	1165.0-1605.0 md

POOL	CODE	AREA OF COVERAGE		REFERENCE WELL	
		Plat	Legal Description (Lsd-Sec-Twp-Rge)	UWI	Interval (m KB)
Mission Canyon 3b B	07 42B	p. 49	-	100/08-07-003-28W1/00	981.5-990.6
Mission Canyon 3b C	07 42C	-	Lsd's 6 & 11-17-3-29	100/06-17-003-29W1/00	1002.0-1016.0
Mission Canyon 3b D	07 42D	p. 50	-	100/13-32-002-29W1/00	1021.1-1033.3
Mission Canyon 3b E	07 42E	p. 50	-	100/11-30-002-28W1/00	990.0-1002.0
Mission Canyon 3b F	07 42F	-	Lsd's 14 & 15-20-2-28	100/14-20-002-28W1/02	987.5-1003.4
Mission Canyon 3b J	07 42J	p. 51	-	100/13-33-001-28W1/00	1002.0-1026.0
Mission Canyon 3b K	07 42K	-	Lsd 5-30-1-28	100/05-30-001-28W1/00	1025.0-1043.5
Mission Canyon 3a A	07 43A	p. 51	-	100/08-16-003-29W1/00	999.7-1018.0
Mission Canyon 3a B	07 43B	p. 52	-	100/09-18-003-28W1/00	976.9-990.6
Mission Canyon 3a C	07 43C	p. 52	-	100/04-12-003-29W1/00	995.0-1015.0
Mission Canyon 3a E	07 43E	-	Lsd 6-10-3-28	100/06-10-003-28W1/00	970.3-985.0
Mission Canyon 3a F	07 43F	-	Lsd 14-5-3-29	100/14-05-003-29W1/03	1085.0-1385.0 md
Mission Canyon 1 A	07 44A	-	Lsd 4-25-3-28	100/04-25-003-28W1/00	948.0-980.0
<b><u>Kirkella Field</u></b>					
Lodgepole Dolomite A	09 51A	p. 53	-	100/14-08-012-29W1/00	725.0-742.0
Lodgepole Dolomite B	09 51B	-	Lsd 13-18-12-29 & Lsd's 4, 5 & 12-19-12-29	100/04-19-012-29W1/00	729.0-744.0
Lodgepole Daly A	09 54A	p. 53	-	100/14-10-012-29W1/00	722.4-734.3
Lodgepole Daly B	09 54B	p. 54	-	100/05-17-012-29W1/00	746.0-755.0
Lodgepole Daly C	09 54C	p. 54	-	100/04-18-012-29W1/00	745.5-757.0
Lodgepole Daly D	09 54D	p. 55	-	100/14-01-012-29W1/00	714.0-740.0
Lodgepole Daly E	09 54E	-	Lsd 16-6-12-29	100/16-06-012-29W1/00	746.0-758.0
Lodgepole Crinoidal A	09 55A	-	Lsd 10-3-12-29	100/10-03-012-29W1/00	758.0-761.5
Lodgepole Crinoidal B	09 55B	-	Lsd 6 & 11-15-12-29	100/11-15-012-29W1/00	716.0-720.0 md
Lodgepole Crinoidal C	09 55C	-	Lsd 7, 10 & 15-10-12-29	100/15-10-012-29W1/00	715.0-729.0

POOL	CODE	AREA OF COVERAGE		REFERENCE WELL	
		Plat	Legal Description (Lsd-Sec-Twp-Rge)	UWI	Interval (m KB)
Bakken A	09 60A	-	Lsd's 12, 13, 14 & 15-15-12-29	100/12-15-012-29W1/02	786.5-791.5
<b><u>Souris Hartney Field</u></b>					
Lodgepole Virden A	10 53A	p. 55	-	100/04-16-006-22W1/00	653.2-671.8
Lodgepole Virden B	10 53B	p. 56	Lsd's 16-10-6-22 & 1-15-6-22	100/01-15-006-22W1/00	645.0-649.5
<b><u>Coulter Field</u></b>					
Lower Amaranth A	11 29A	p. 56	-	100/11-21-001-27W1/00	933.0-969.0
Mission Canyon 3 A	11 41A	-	Lsd's 1, 2, 7 & 8-21-1-27	100/07-21-001-27W1/00	968.6-977.8
Mission Canyon 3b A	11 42A	-	Lsd's 8 & 9-6-2-27	100/08-06-002-27W1/00	966.0-975.0
<b><u>Regent Field</u></b>					
Lodgepole WL A	13 52A	p. 57	-	100/16-02-004-22W1/00	761.5-780.0
Lodgepole Virden A	13 53A	p. 57	-	100/06-07-004-21W1/00	766.9-781.8
Lodgepole Virden B	13 53B	-	Lsd 14-13-4-22	100/14-13-004-22W1/00	759.0-780.0
<b><u>Mountainside Field</u></b>					
Lodgepole WL A	14 52A	p. 58	-	103/11-16-002-21W1/00	1078.0-1451.4
<b><u>Birdtail Field</u></b>					

POOL	CODE	AREA OF COVERAGE		REFERENCE WELL	
		Plat	Legal Description (Lsd-Sec-Twp-Rge)	UWI	Interval (m KB)
Bakken A	15 60A	p. 58	-	100/05-04-016-27W1/00	518.5-524.5
Bakken B	15 60B	-	Lsd 9-9-16-27	100/09-09-016-27W1/00	518.5-527.5
Bakken C	15 60C	p. 59	-	100/01-19-016-27W1/00	519.5-524.8
Bakken D	15 60D	-	Lsd 4-3-16-27	100/04-03-016-27W1/00	525.5-530.5
Bakken E	15 60E	-	Lsd B09-8-16-27	103/09-08-016-27W1/00	520.0-525.0
<b><u>Sinclair Field</u></b>					
Lodgepole A	16 59A	-	Lsd 10-18-7-29	100/10-18-007-29W1/00	927.5-932.5
Lodgepole B	16 59B	-	Lsd 2-21-07-28	100/02-21-007-28W1/00	823.9-934.0
Bakken-Three Forks A	16 62A	p. 59	-	100/10-18-007-29W1/00	1081.0-1087.0
Bakken-Three Forks B	16 62B	p. 60	-	102/03-07-008-29W1/00	1014.0-1020.0
Bakken-Three Forks D	16 62D	-	Lsd 11-7-7-29	100/11-07-007-29W1/00	1066.0-1072.4
Bakken-Three Forks E	16 62E	-	Lsd 10-18-7-29	100/10-18-007-29W1/02	1061.6-1063.0
Bakken-Three Forks G	16 62G	-	Lsd 4-22-7-29	100/04-22-007-29W1/00	1014.0-1016.0
Bakken-Three Forks H	16 62H	p. 60	-	100/08-26-007-29W1/00	974.0-976.0
Bakken-Three Forks I	16 62I	-	Lsd 16-18-7-28	100/16-18-007-28W1/00	950.0-952.0
Bakken-Three Forks J	16 62J	-	Lsd 2-28-8-29	100/02-28-008-29W1/00	960.0-962.0
Bakken-Three Forks K	16 62K	-	Lsd 13-20-7-28	100/13-20-007-28W1/00	938.0-941.0
<b><u>Other Areas</u></b>					
Melita A	99 19A	-	Lsd's 13 & 14-15-16-29 & Lsd's 3 & 4-22-16-29	100/14-15-016-29W1/00	432.3-446.0
Lower Amaranth H	99 29H	-	Lsd 3-24-1-28	100/03-24-001-28W1/00	953.0-990.0
Lower Amaranth K	99 29K	-	Lsd 13-10-2-24	100/13-10-002-24W1/00	869.5-879.5

POOL	CODE	AREA OF COVERAGE		REFERENCE WELL	
		Plat	Legal Description (Lsd-Sec-Twp-Rge)	UWI	Interval (m KB)
Lower Amaranth-Lodgepole	99 40A	-	Lsd 3-33-8-24	100/03-33-008-24W1/00	570.0-584.0
Mission Canyon 1 A	99 44A	p. 61	-	100/08-31-002-23W1/00	812.0-843.0
Mission Canyon 1 D	99 44D	-	Lsd 16-2-3-26	100/16-02-003-26W1/00	879.0-922.0
Mission Canyon 1 E	99 44E	p. 61	-	100/16-06-006-28W1/00	905.0-908.0
Mission Canyon 1 G	99 44G	p. 62	-	100/02-16-006-26W1/00	855.0-1229.0 md
Mission Canyon 1 H	99 44H	p. 62	-	100/03-13-006-27W1/00	786.5-790.0
Mission Canyon 1 J	99 44J	-	Lsd 11-36-5-29	100/11-36-005-29W1/00	923.0-927.5
Mission Canyon 1 K	99 44K	-	Lsd's 1, 8 & 9-2-7-27	100/09-02-007-27W1/00	777.0-779.5
Mission Canyon 1 J	99 44L	-	Lsd 6-3-7-27	100/06-03-007-27W1/00	789.7-794.0
Mission Canyon 1 M	99 44M	-	Lsd 5-35-2-24	100/05-35-002-24W1/00	842.0-845.0
Lodgepole WL B	99 52B	-	Lsd 15-21-4-22	100/15-21-004-22W1/00	758.6-777.8
Lodgepole WL C	99 52C	p. 63	-	100/13-19-004-22W1/00	762.0-775.7
Lodgepole WL D	99 52D	-	Lsd 1-34-4-22	100/01-34-004-22W1/00	747.4-760.2
Lodgepole WL F	99 52F	-	Lsd 4-3-5-22	100/04-03-005-22W1/00	747.5-752.0
Lodgepole Virden C	99 53C	-	Lsd 5-32-2-23	100/05-32-002-23W1/00	827.0-828.5
Lodgepole A	99 59A	-	Lsd 15-16-11-27	100/15-16-011-27W1/00	646.2-734.0
Lodgepole B	99 59B	-	Lsd 6-16-11-29	100/06-16-011-29W1/00	740.7-783.6
Lodgepole H	99 59H	-	Lsd 16-35-8-29 & Lsd 13-36-8-29	100/16-35-008-29W1/00	812.0-880.0
Lodgepole I	99 59I	-	Lsd's 1 & 8-33-2-24 & Lsd's 4, 5, 6, 11 & 12-34-2-24	100/11-35-002-24W1/00	960.0-1955 md, 1063-1308 md

**MANITOBA DESIGNATED POOLS  
( POOL PLATS )**

Rge 29 WPM      Rge 28 WPM      Rge 27 WPM

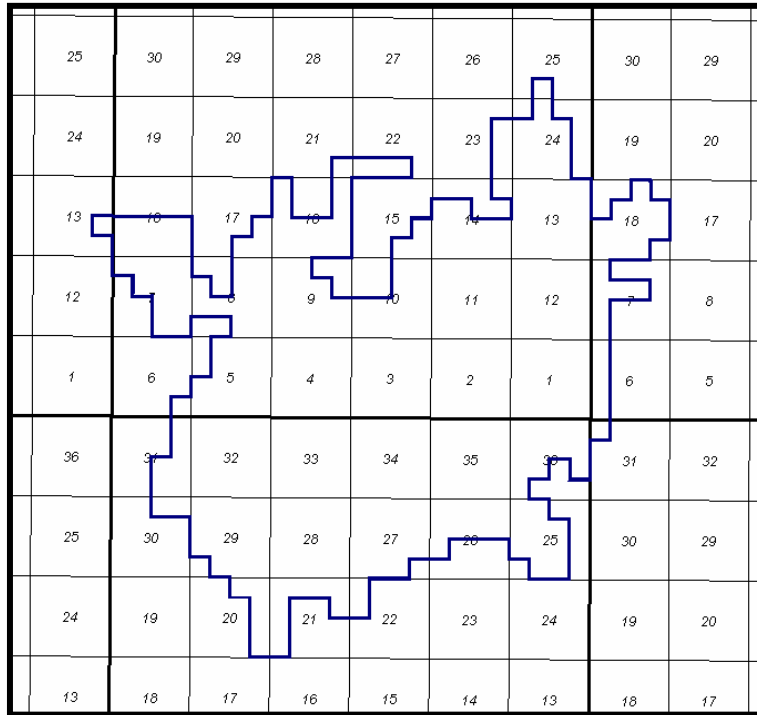

**DALY LODGEPOLE A POOL  
01 59A**

**Twp  
10**

**Twp  
9**

Rge 28 WPM      Rge 27 WPM

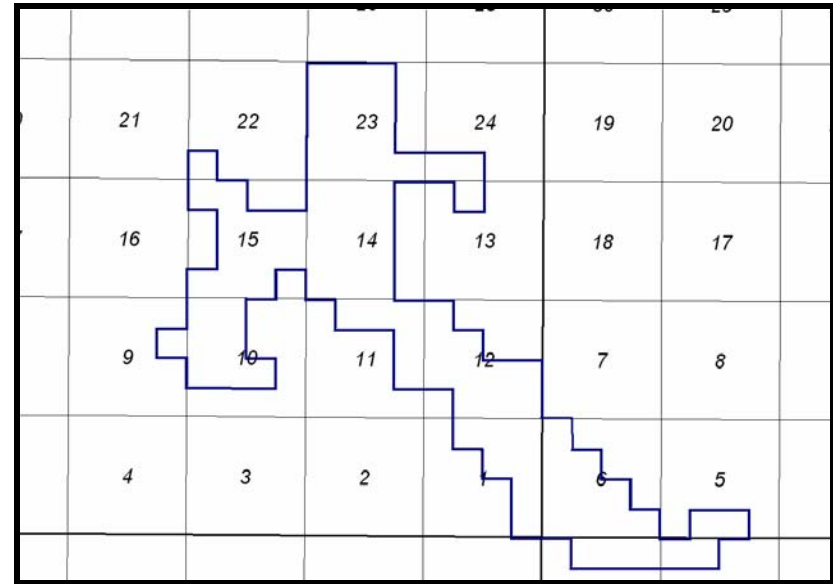

**Twp  
9**

**Twp  
8**

**DALY LODGEPOLE B POOL  
01 59B**

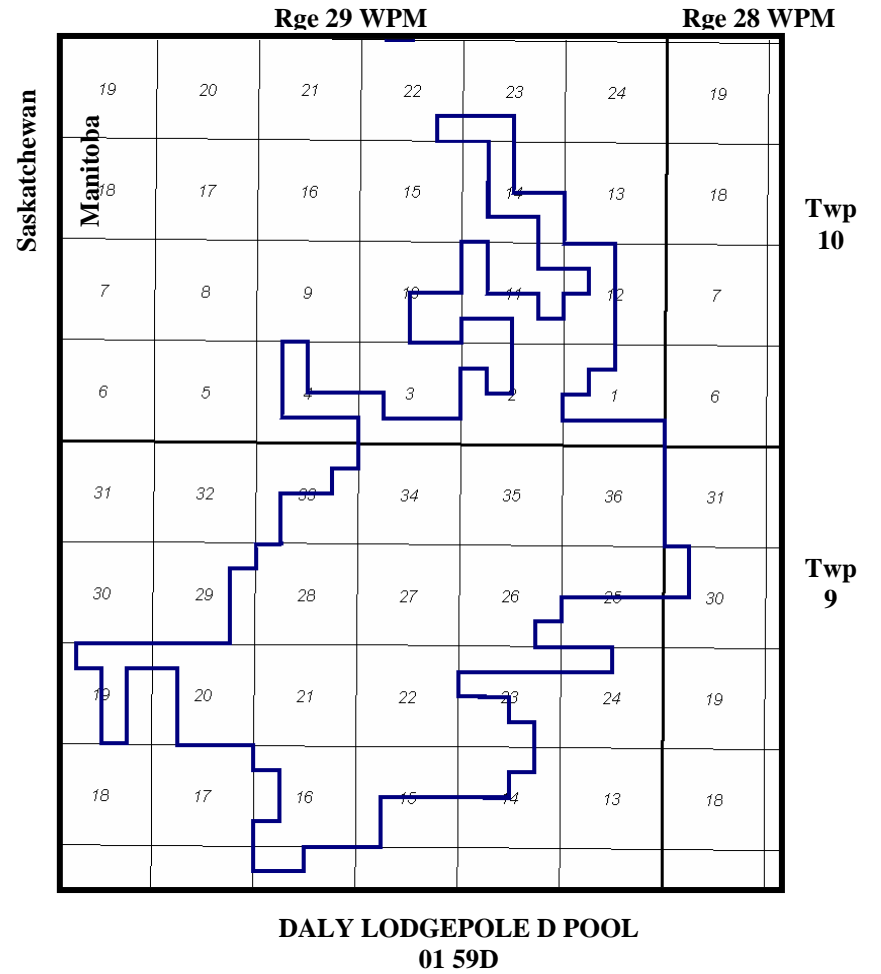
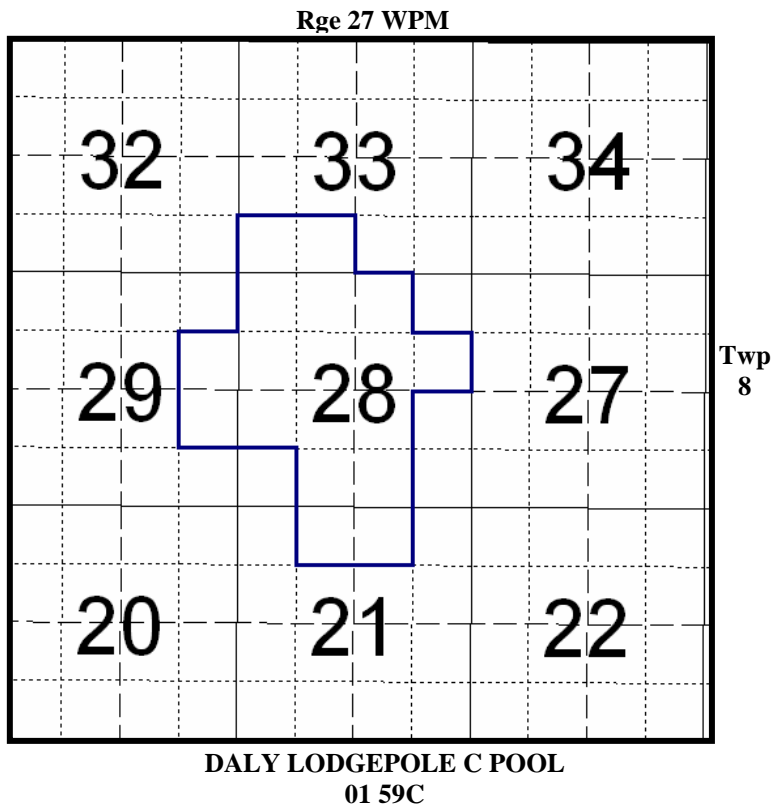



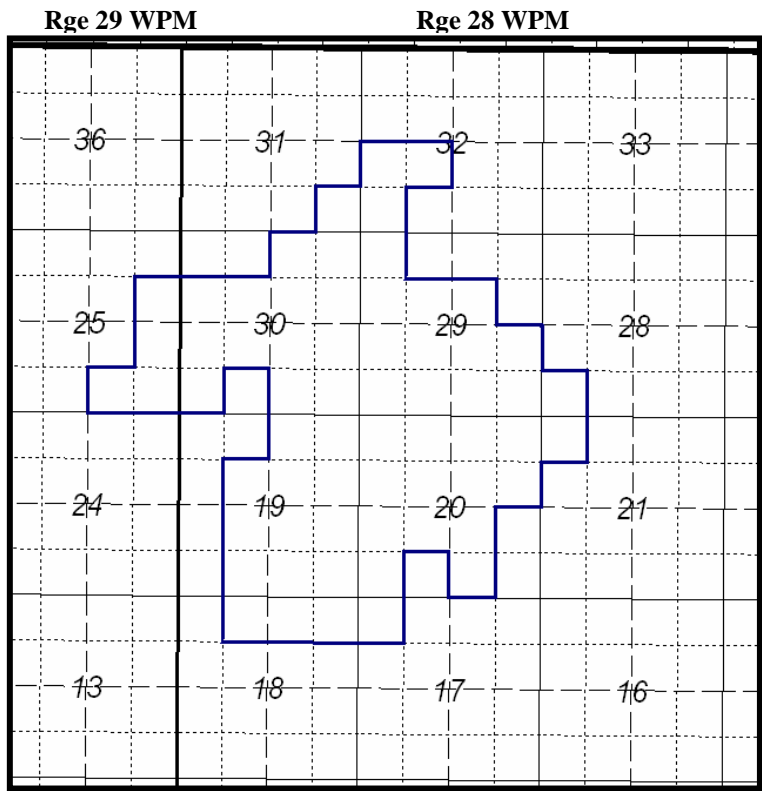

**DALY LODGEPOLE E POOL  
01 59E**

Twp  
10

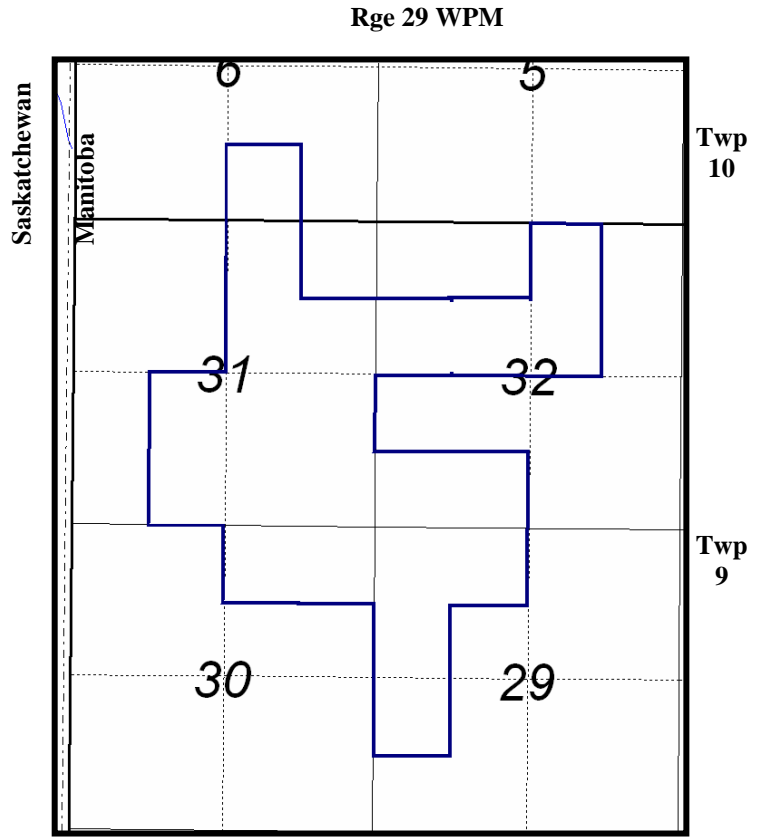

**DALY LODGEPOLE F POOL  
01 59F**

Rge 29 WPM

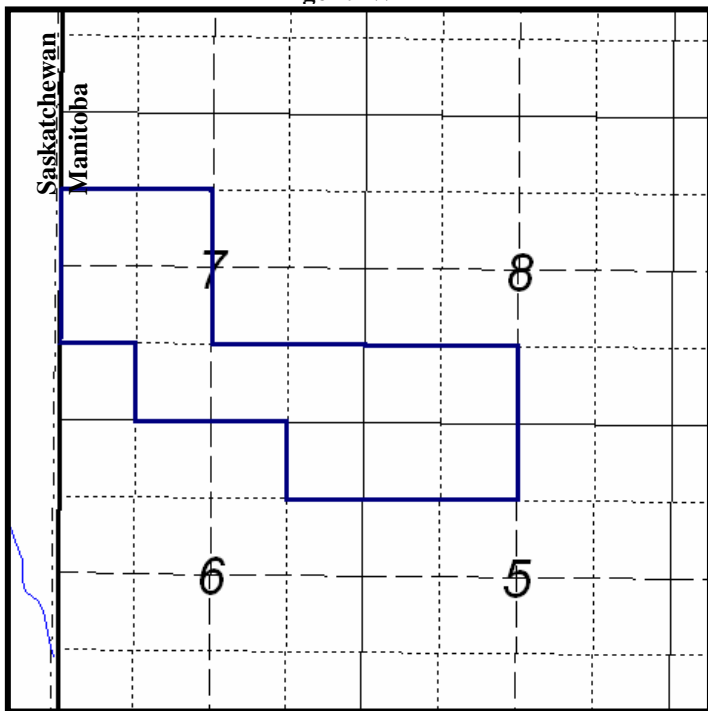

DALY LODGEPOLE I POOL  
01 59I

Twp  
10

Rge 28 WPM

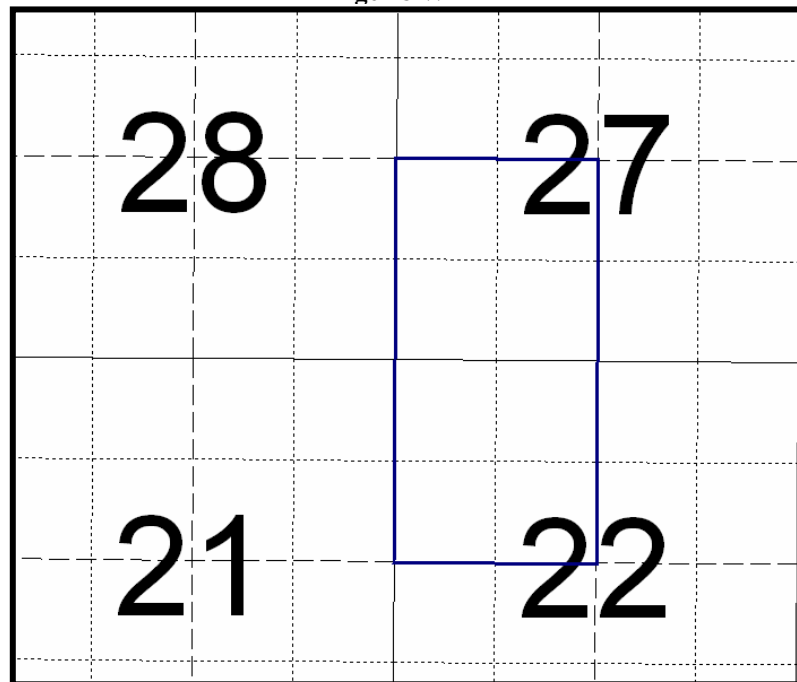

DALY LODGEPOLE O POOL  
01 59O

Twp  
8

Rge 28 WPM

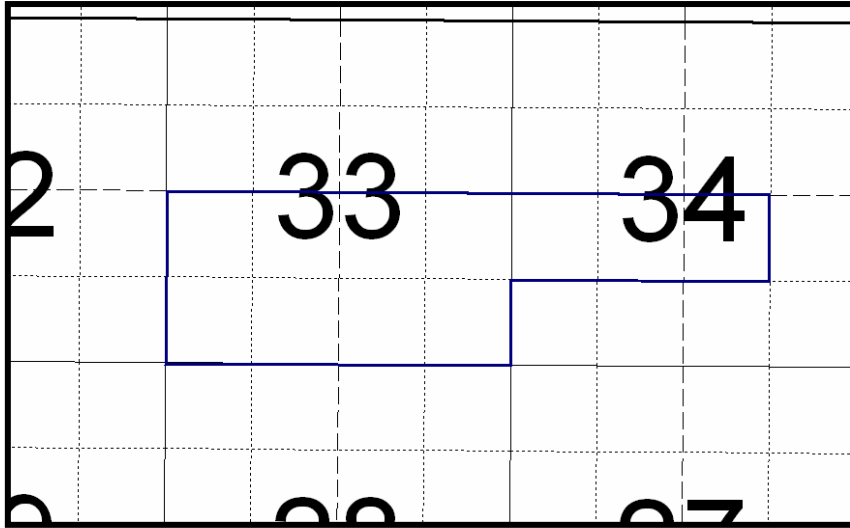

DALY LODGEPOLE Q POOL  
01 59Q

Twp  
8

Rge 29 WPM

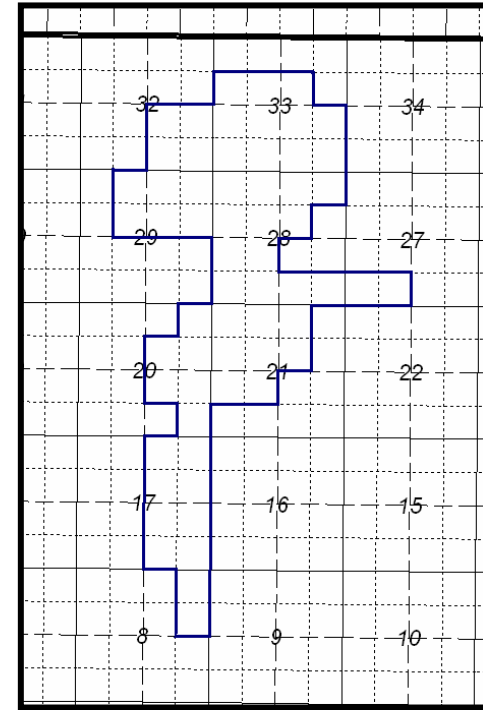

Twp  
10

DALY BAKKEN A POOL  
01 60A

Rge 29 WPM

Rge 28 WPM

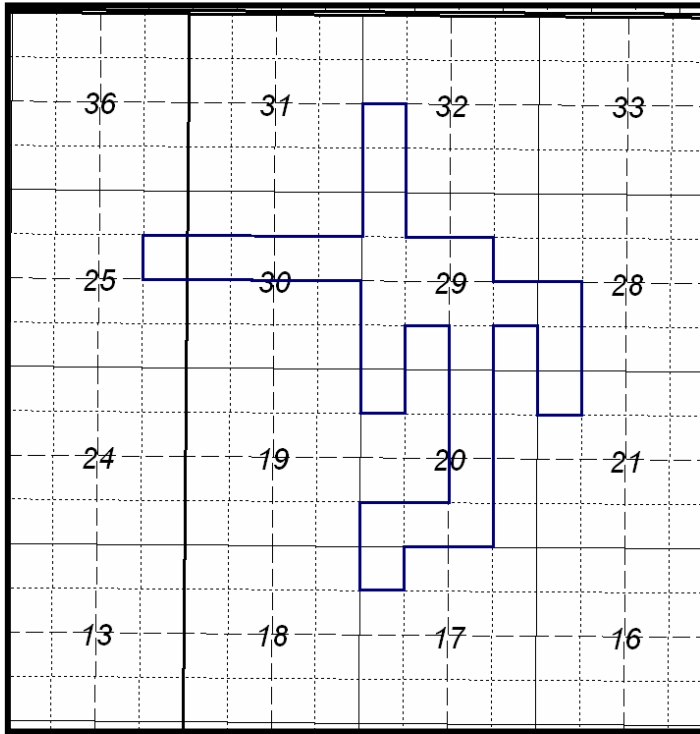

DALY BAKKEN B POOL  
01 60B

Twp  
10

Rge 29 WPM

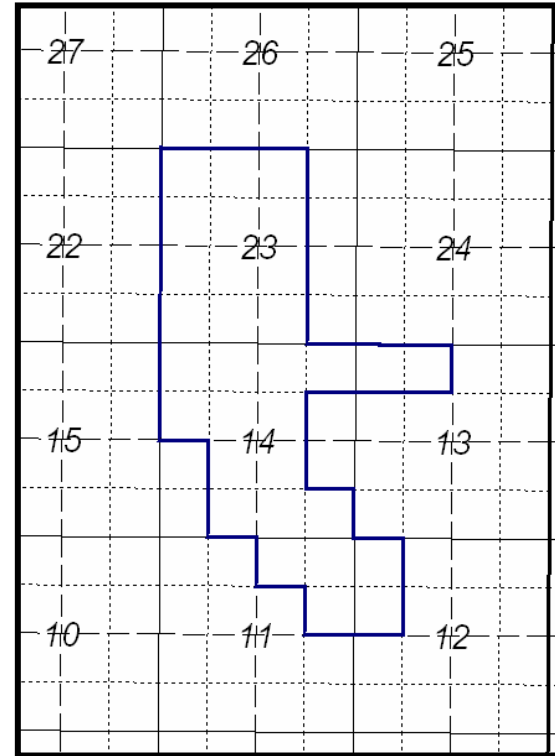

DALY BAKKEN I POOL  
01 60I

Twp  
9

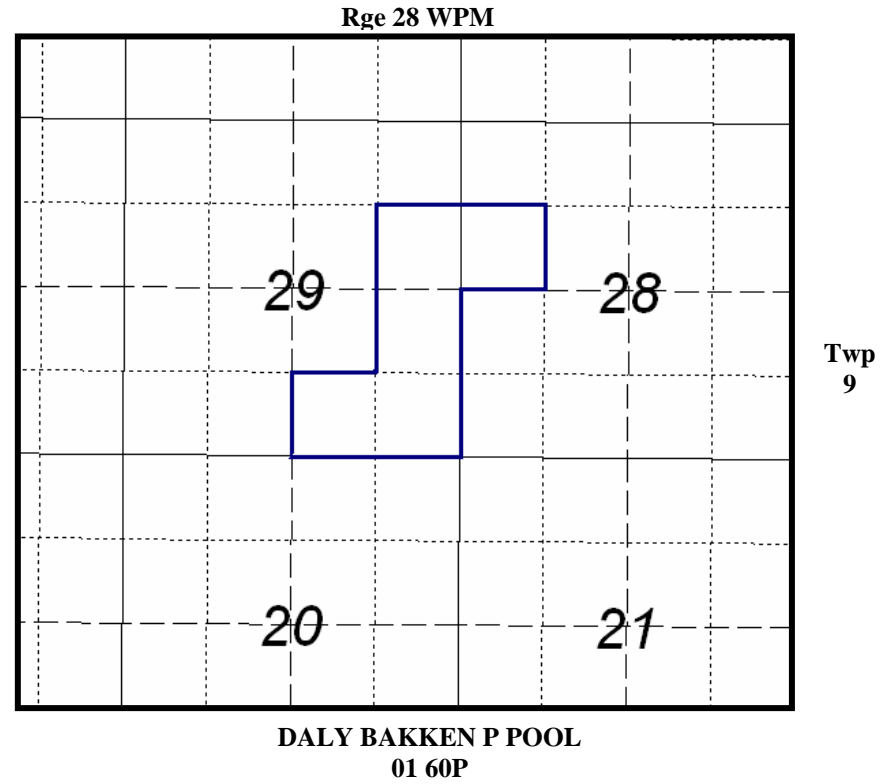
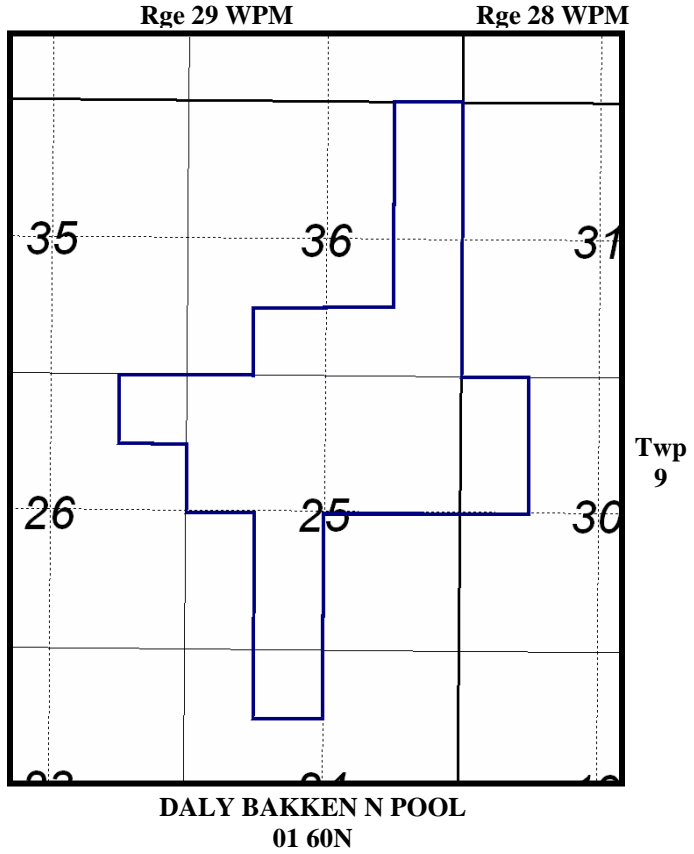

Twp  
9

Twp  
9

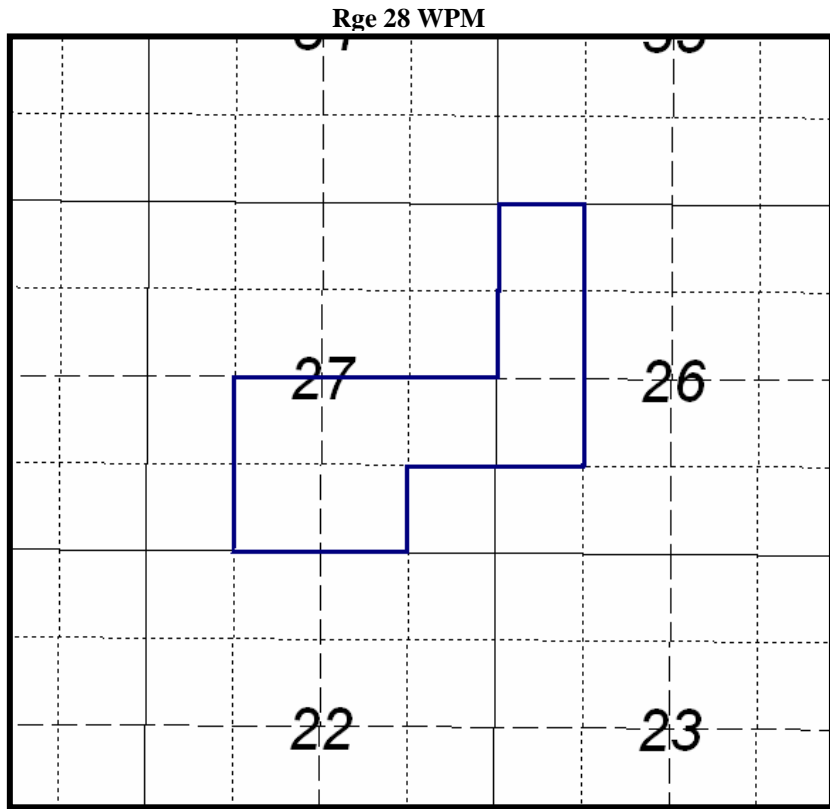

**DALY BAKKEN Q POOL**  
01 60Q

Twp  
9

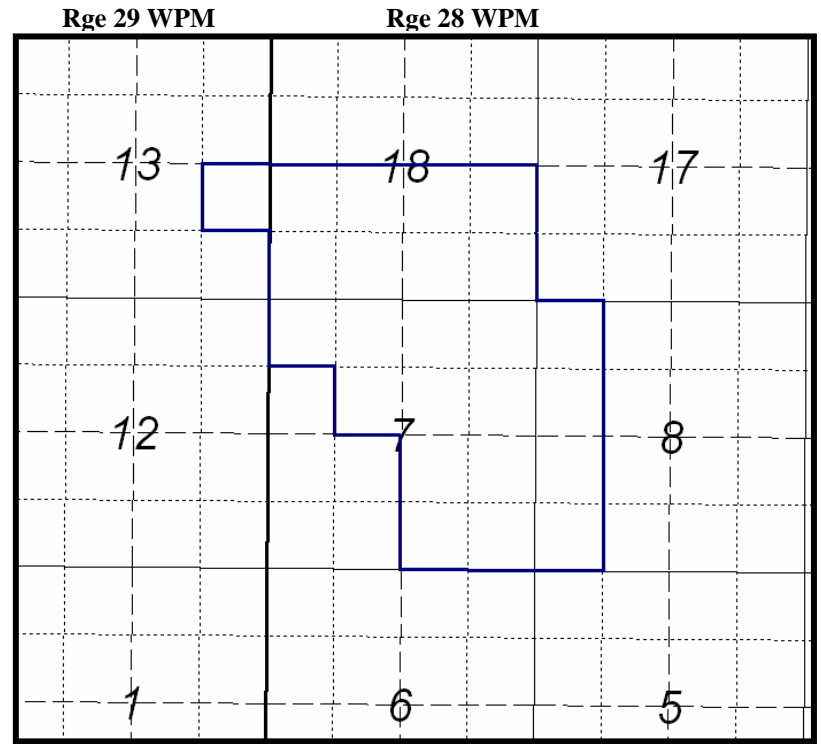

**DALY BAKKEN Z POOL**  
01 60Z

Twp  
10

Rge 29 WPM

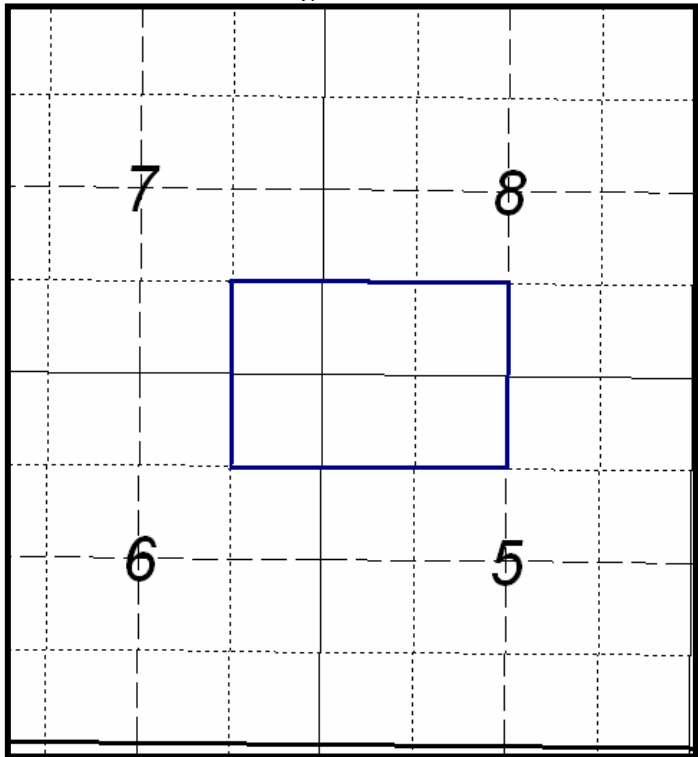

Twp  
10

DALY BAKKEN BB POOL  
01 60BB

Rge 28 WPM

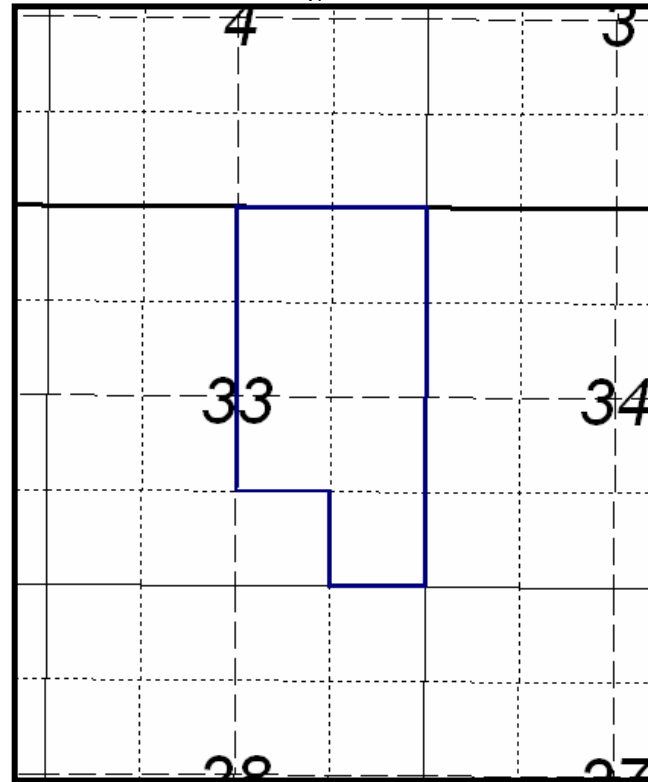

Twp  
10

Twp  
9

DALY BAKKEN DD POOL  
01 60DD

Rge 29 WPM

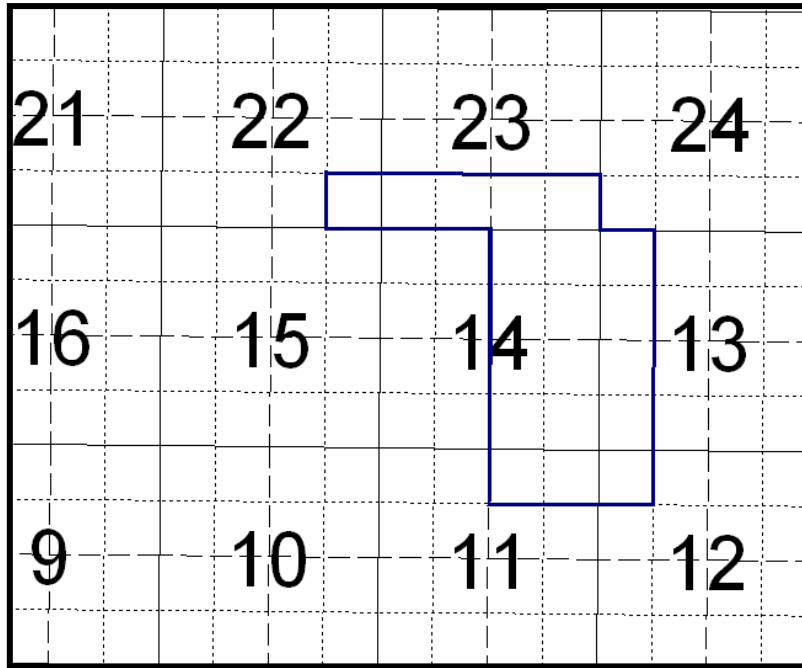

**DALY BAKKEN - THREE FORKS A POOL**  
01 62A

Rge 29 WPM

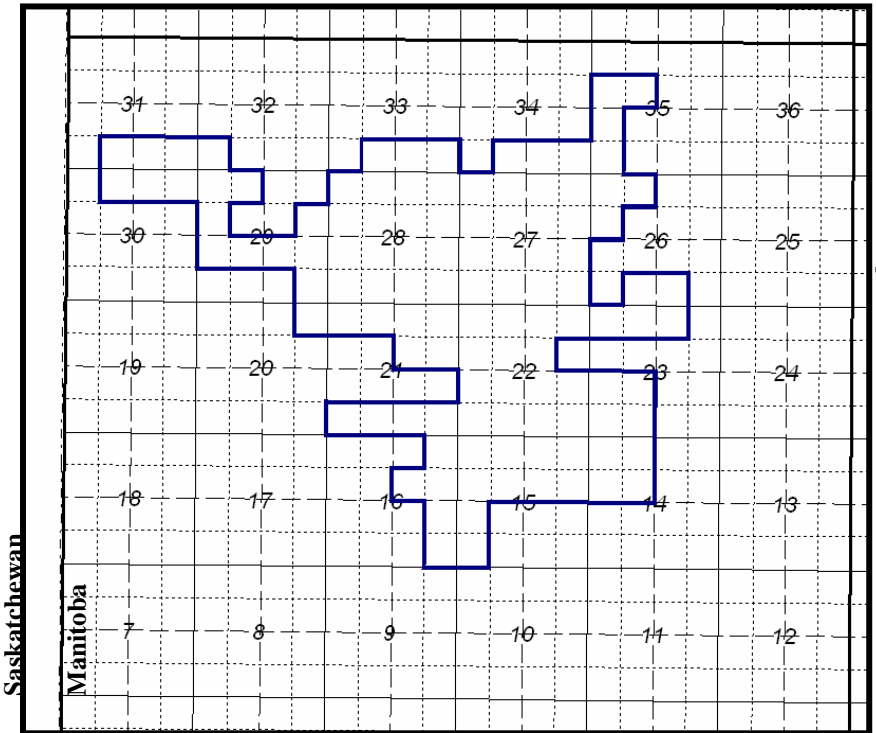

**DALY BAKKEN-THREE FORKS B POOL**  
01 62B



Rge 29 WPM

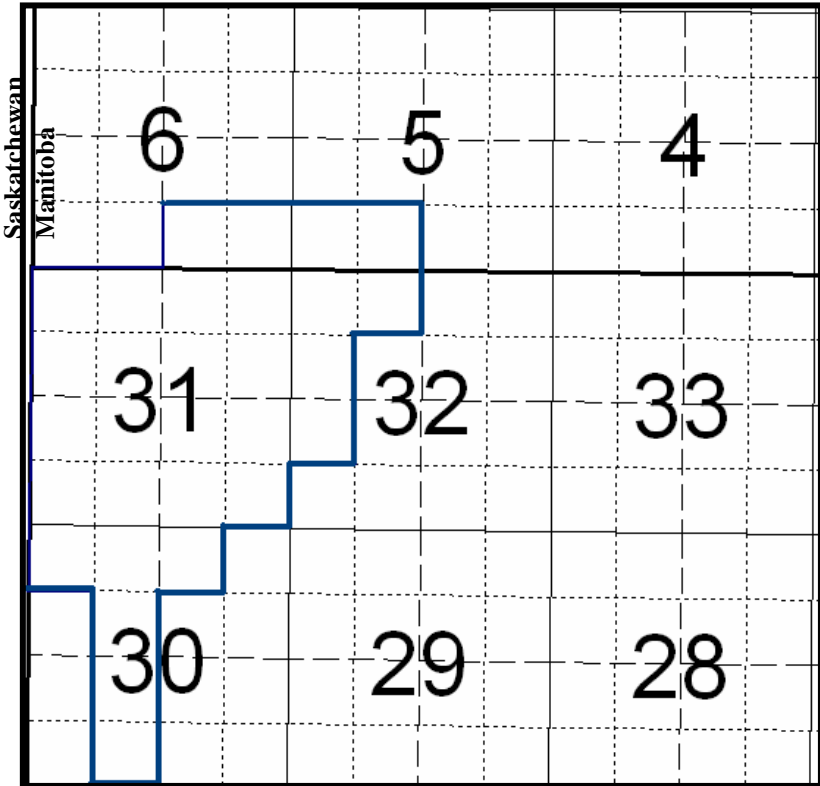

TILSTON MISSION CANYON 1A POOL  
02 44A

Rge 29 WPM

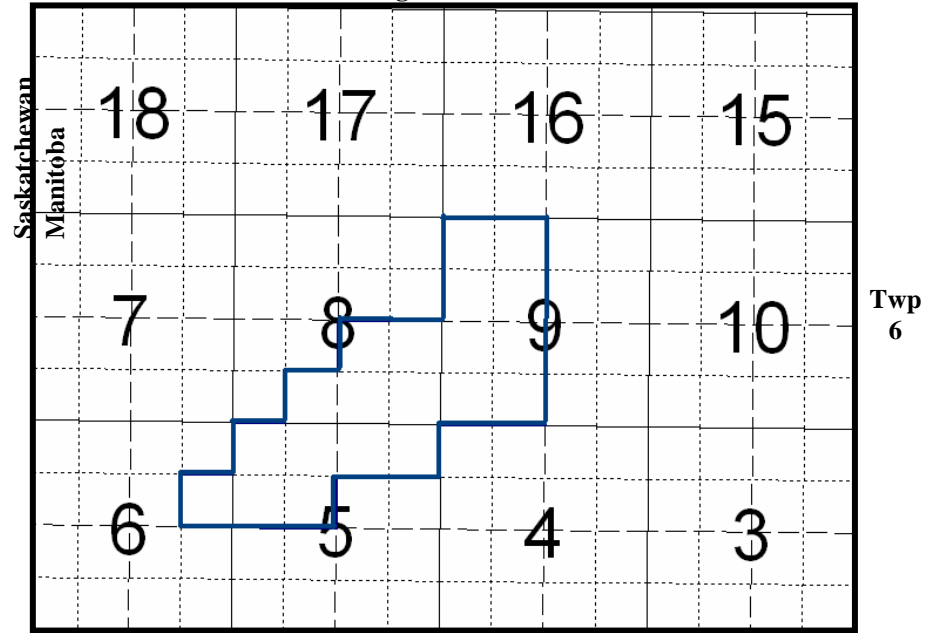

TILSTON MISSION CANYON 1C POOL  
02 44C

**Rge 29 WPM**

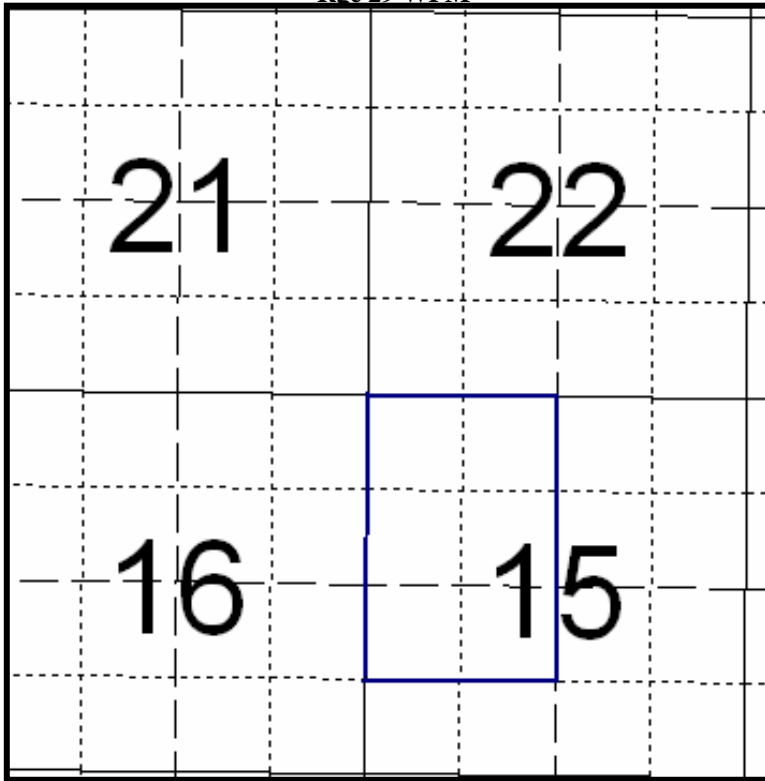

**TILSTON MISSION CANYON 1D POOL  
02 44D**

**Twp  
6**

**Rge 26 WPM**

**Rge 25 WPM**

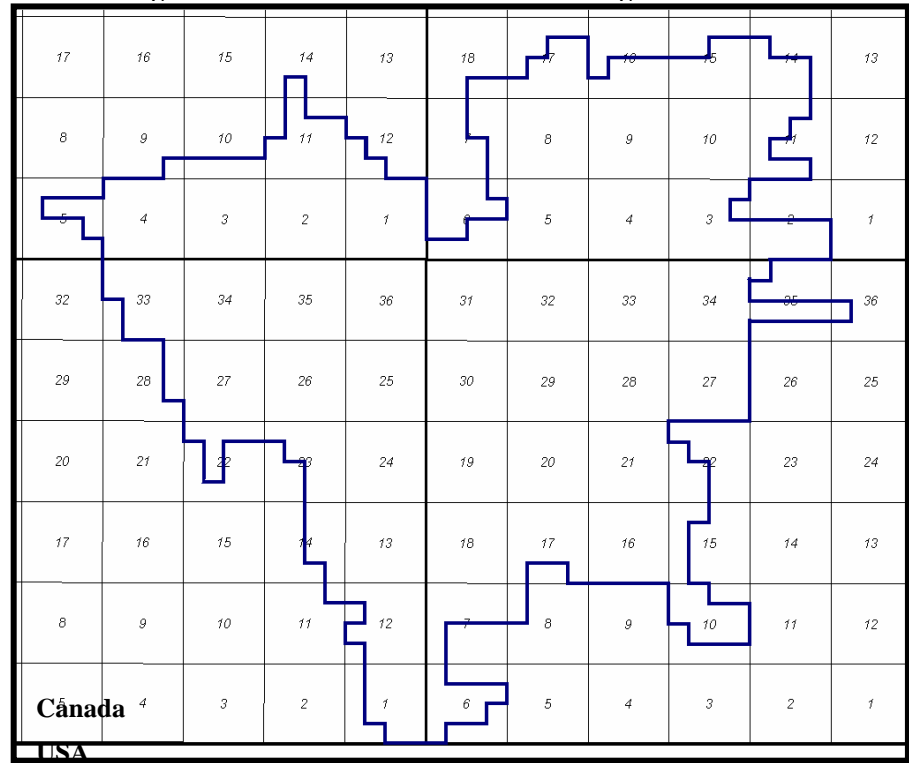

**Twp  
2**

**Twp  
1**

**WASKADA LOWER AMARANTH A POOL  
03 29A**

Rge 25 WPM

Rge 24 WPM

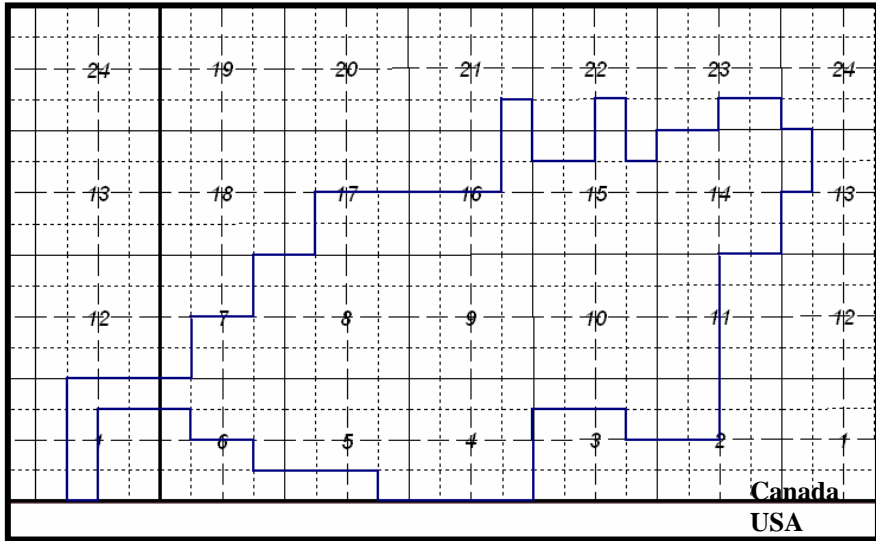

WASKADA LOWER AMARANTH I POOL  
03 29I

Twp  
1

Rge 25 WPM

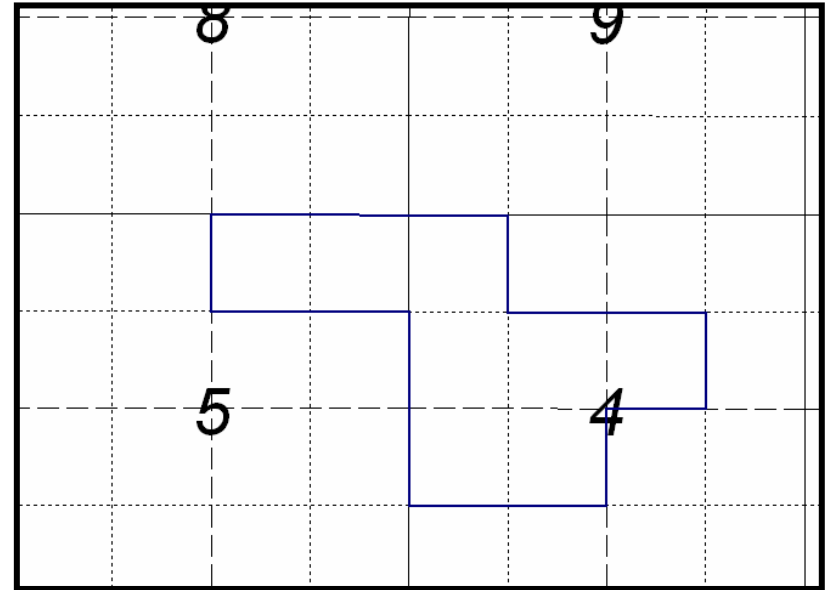

Twp  
1

WASKADA LOWER AMARANTH L POOL  
03 29L

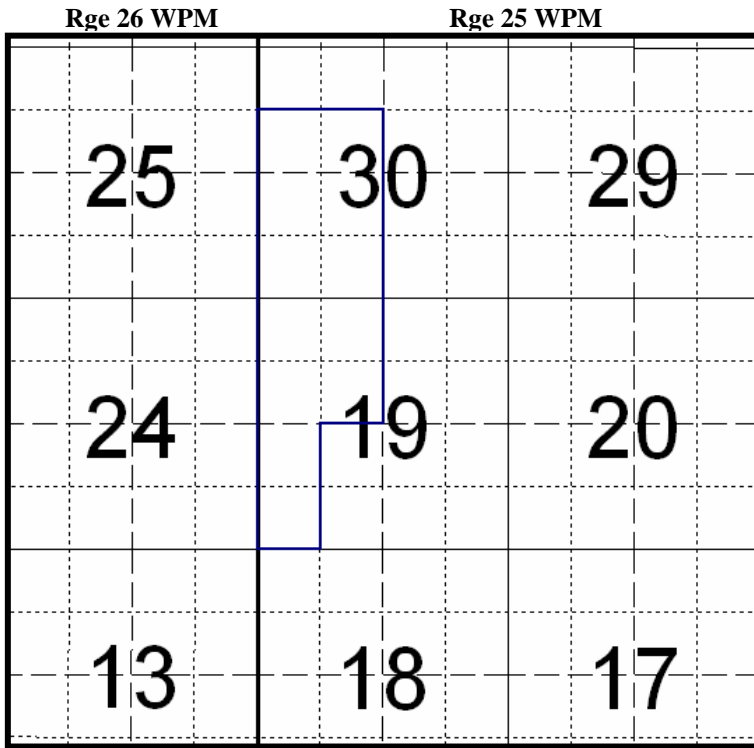

WASKADA MISSION CANYON 3b A POOL  
03 42A

Twp  
1

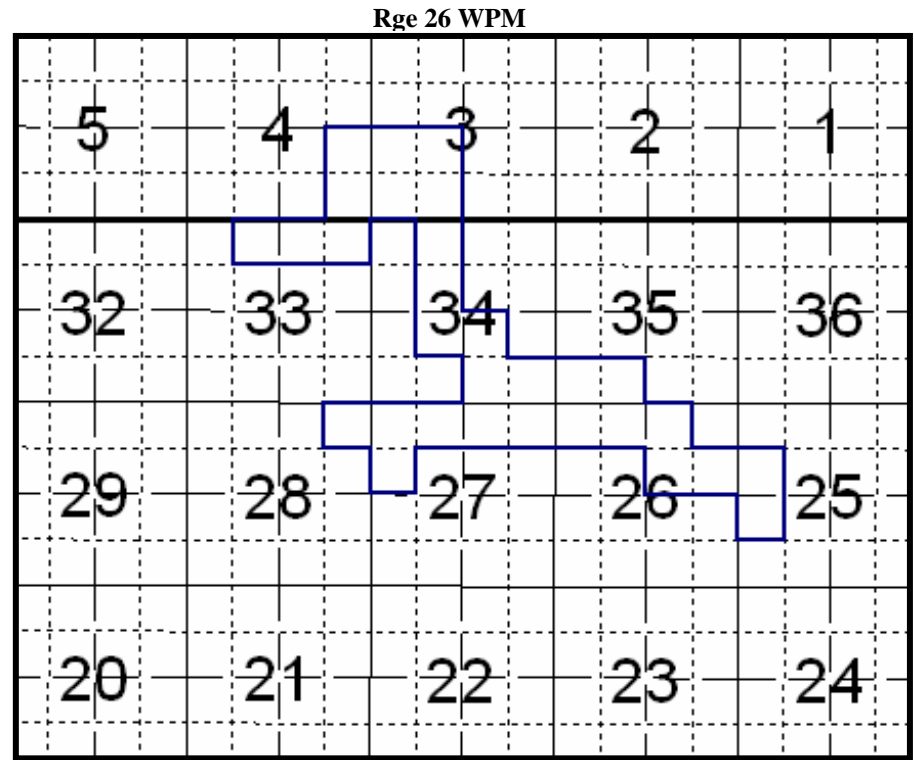

Twp  
2

Twp  
1

WASKADA MISSION CANYON 3b B POOL  
03 42B

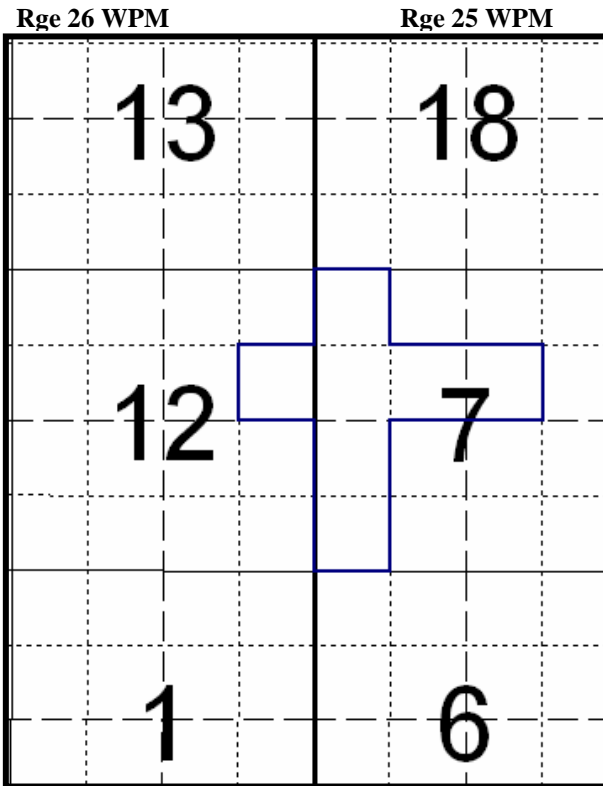

Twp  
1

WASKADA MISSION CANYON 3b C POOL  
03 42C

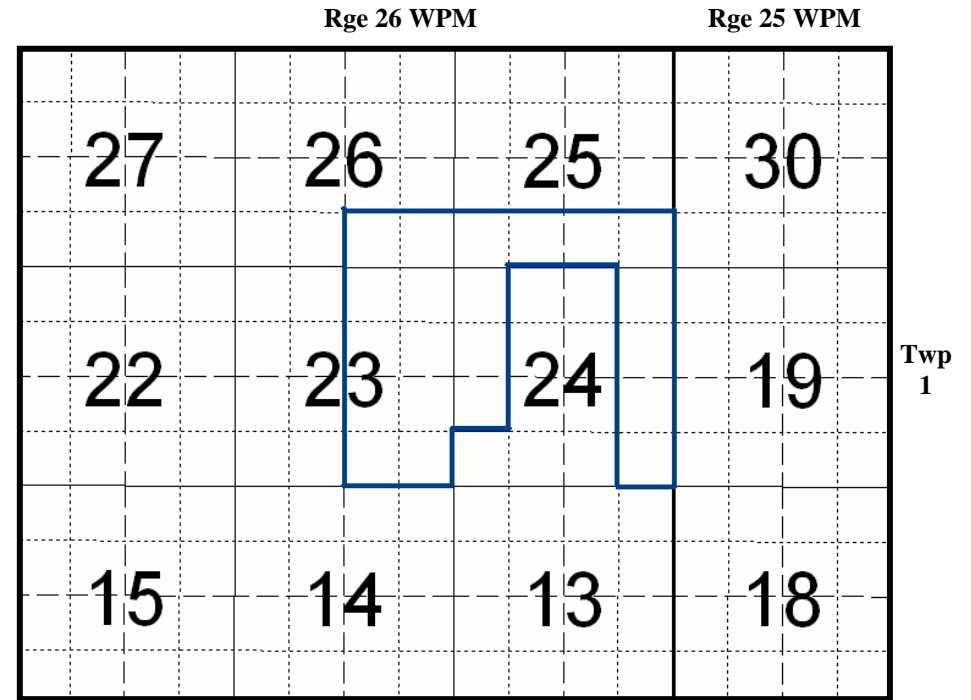

Twp  
1

WASKADA MISSION CANYON 3a A POOL  
03 43A

Rge 26 WPM

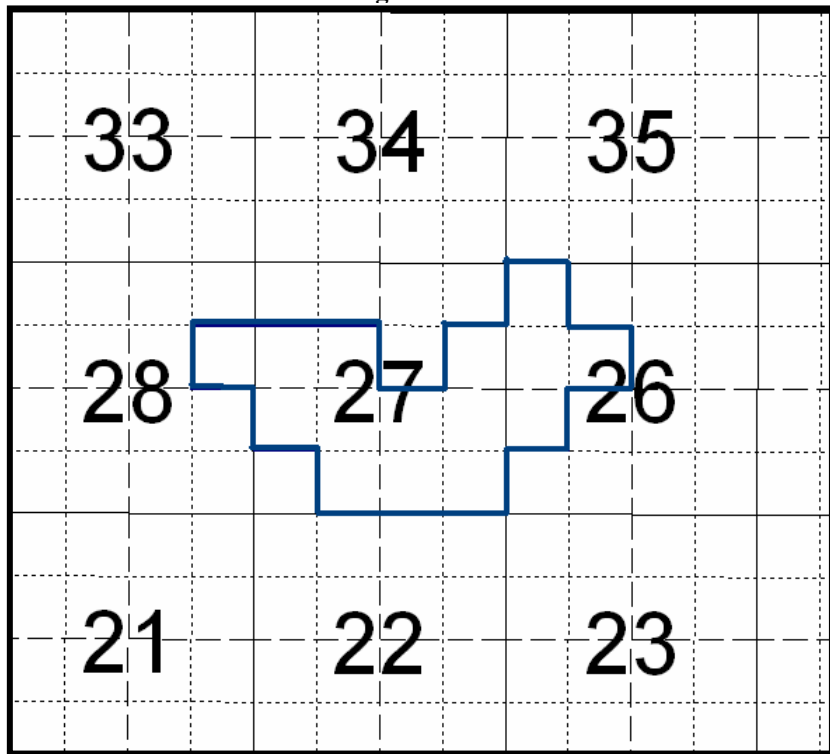

WASKADA MISSION CANYON 3a C POOL  
03 43C

Twp  
1

Rge 26 WPM

Rge 25 WPM

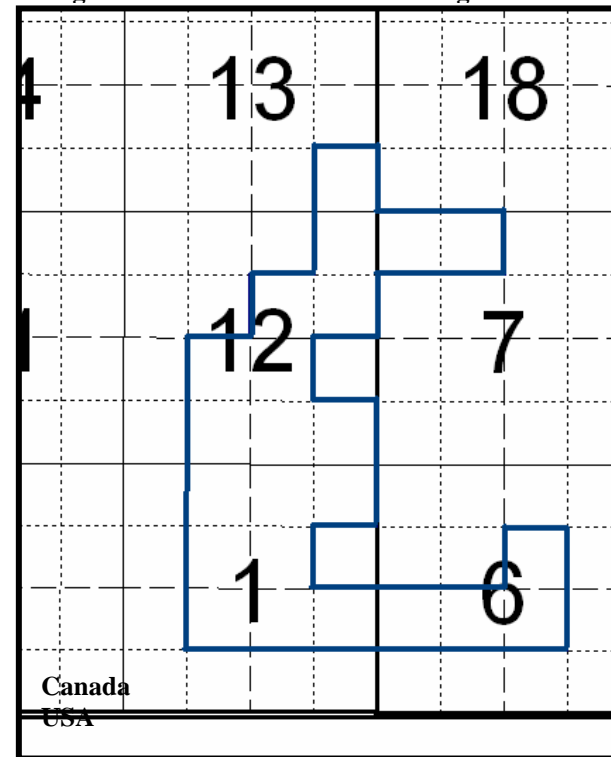

WASKADA MISSION CANYON 3a E POOL  
03 43E

Twp  
1

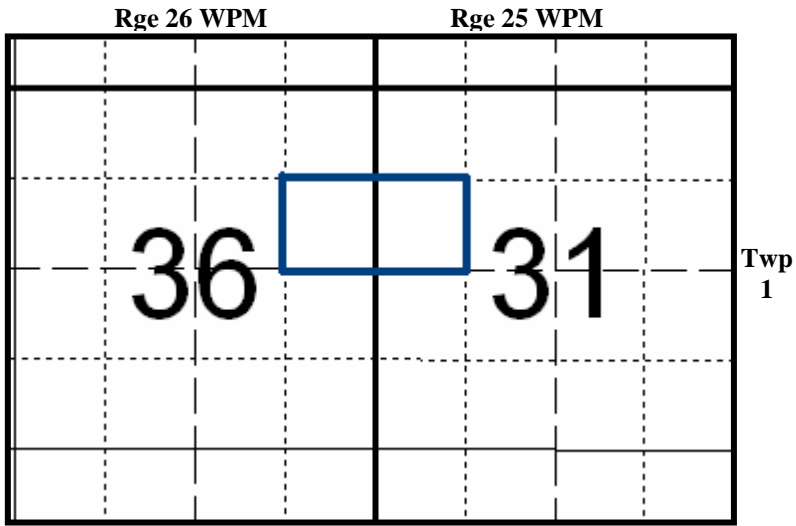

WASKADA MISSION CANYON 3a G POOL  
03 43G

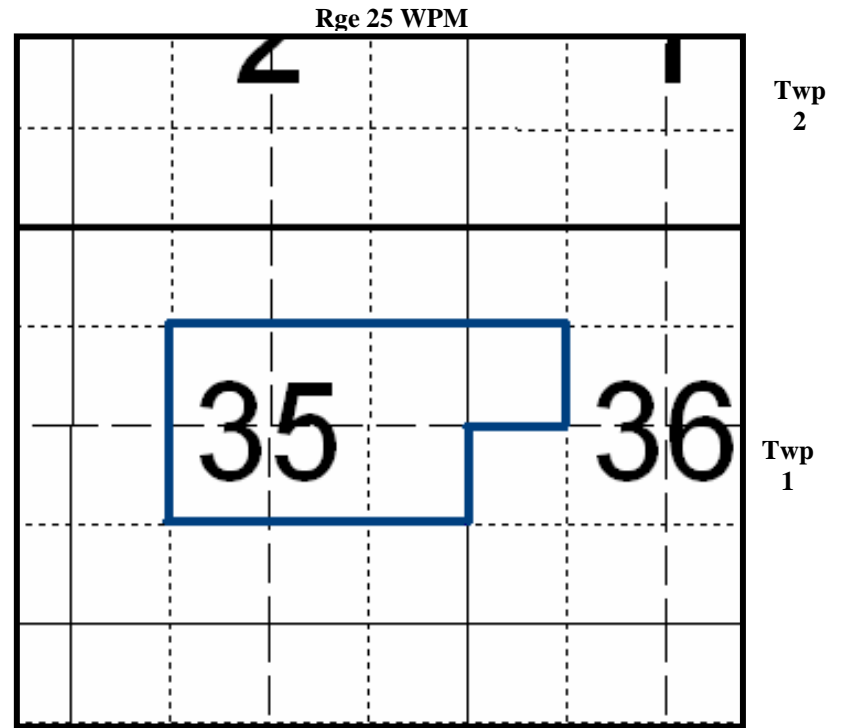

WASKADA MISSION CANYON 3A I POOL  
03 43I

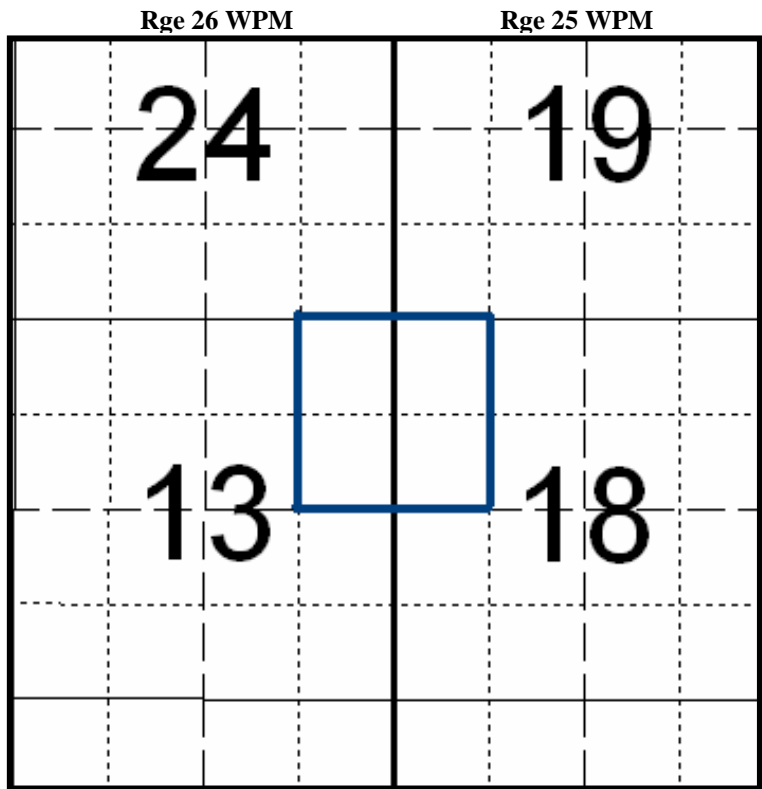

WASKADA MISSION CANYON IB POOL  
03 44B

Twp  
1

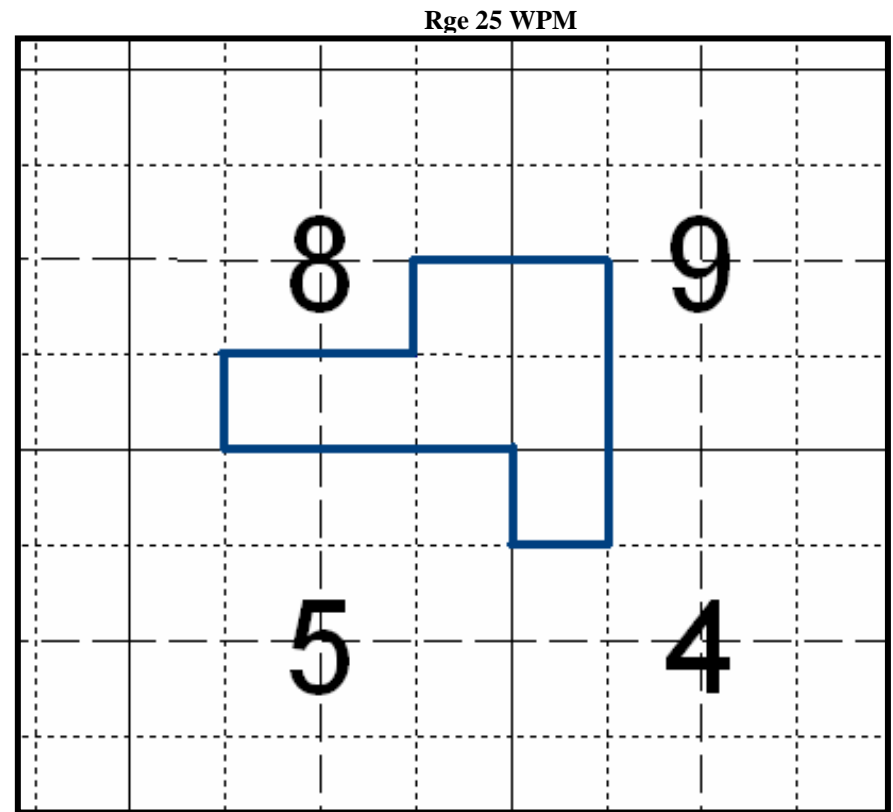

Twp  
2

WASKADA MISSION CANYON 1D POOL  
03 44D



Rge 25 WPM

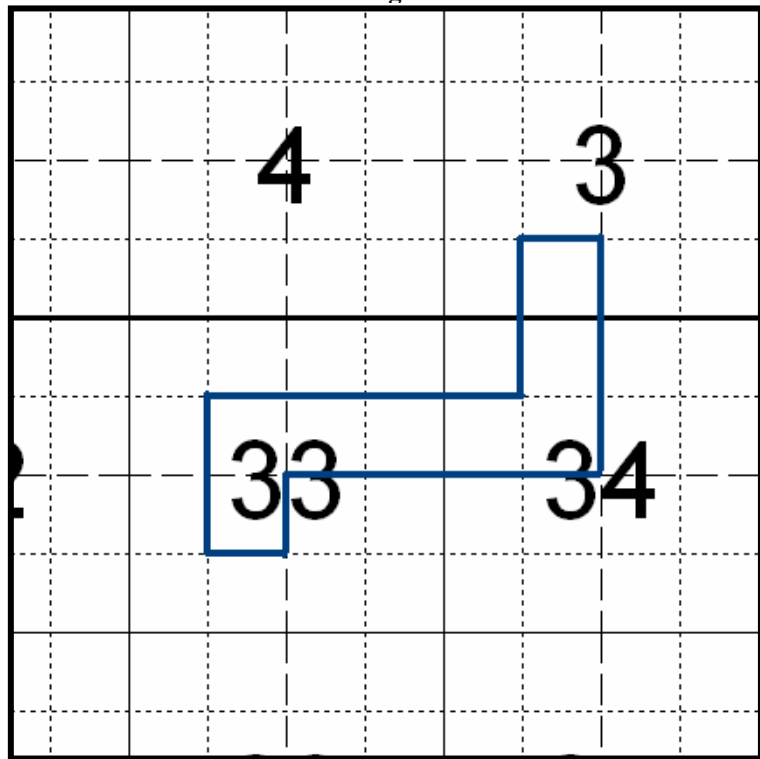

Twp  
2

Twp  
1

WASKADA MISSION CANYON IE POOL  
03 44E

Rge 21 WPM

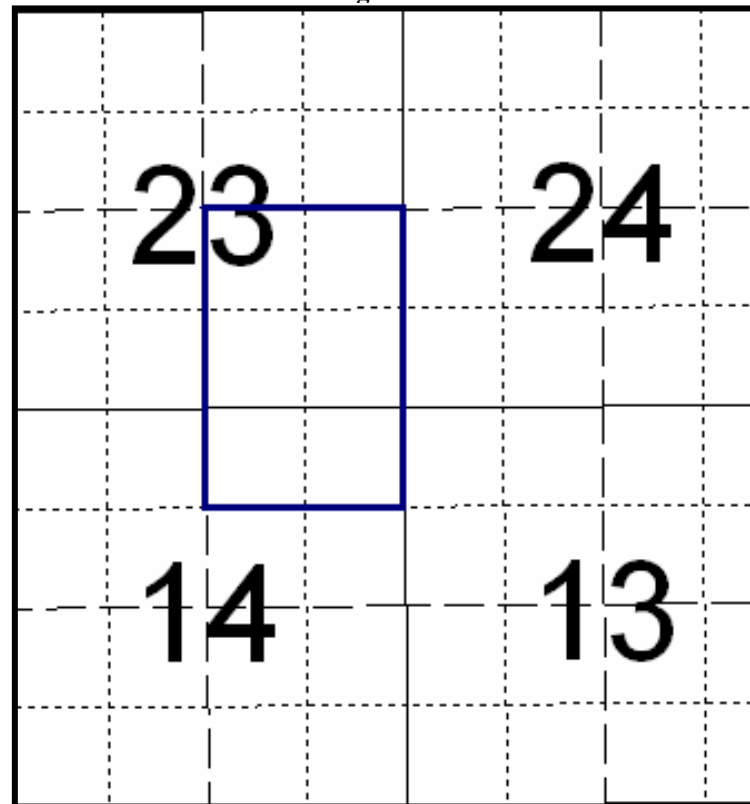

Twp  
1

LULU LAKE LODGEPOLE WL A POOL  
04 52A

Rge 21 WPM

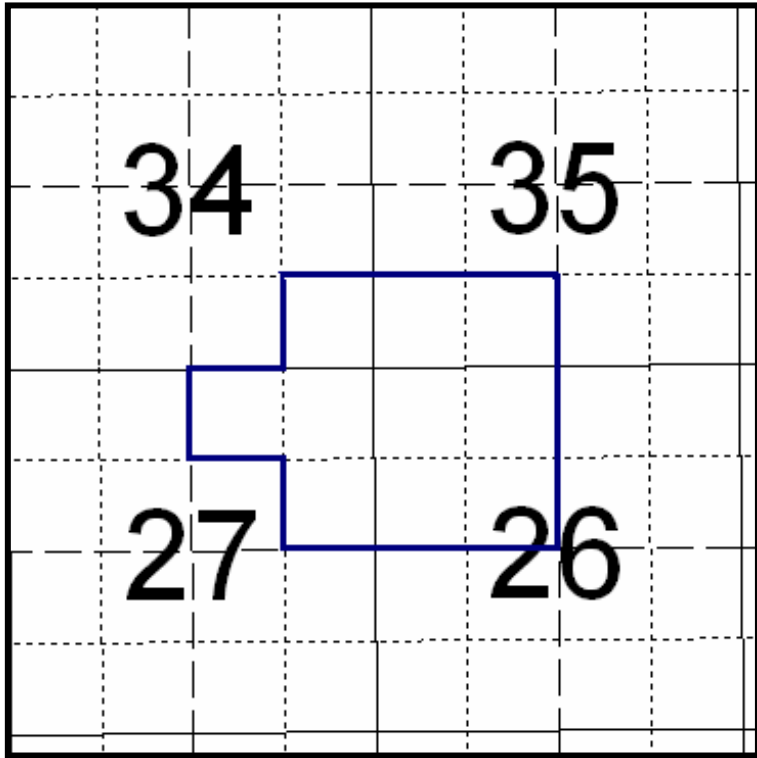

Twp  
1

LULU LAKE LODGEPOLE WL B POOL  
04 52B

Rge 27 WPM

Rge 26 WPM

Rge 25 WPM

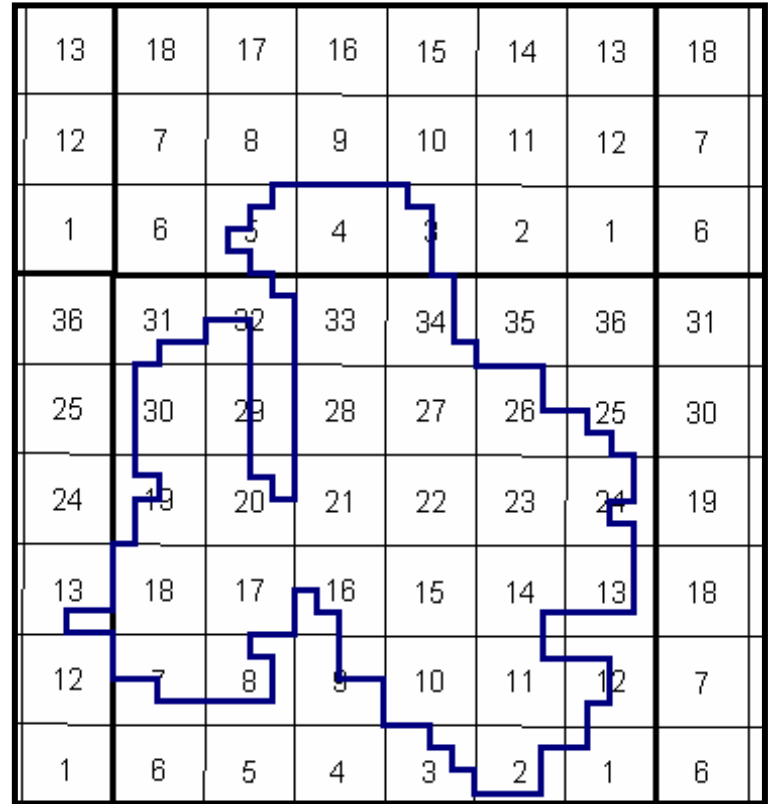

Twp  
12

Twp  
11

VIRDEN LODGEPOLE A POOL  
05 59A

Rge 26 WPM						Rge 25 WPM					
7	8	9	10	11	12	7	8	9	10	11	Twp 11
6	5	4	3	2	1	6	5	4	3	2	
36	31	32	33	34	35	36	31	32	33	34	Twp 10
25	30	29	28	27	26	25	30	29	28	27	
24	19	20	21	22	23	24	19	20	21	22	
13	18	17	16	15	14	13	18	17	16	15	
12	7	8	9	10	11	12	7	8	9	10	Twp 9
1	6	5	4	3	2	1	6	5	4	3	
36	31	32	33	34	35	36	31	32	33	34	
25	30	29	28	27	26	25	30	29	28	27	

**VIRDEN LODGEPOLE B POOL  
05 59B**

Rge 26 WPM			Rge 25 WPM				
1	6	5	4	3	2	1	Twp 10
36	31	32	33	34	35	36	
25	30	29	28	27	26	25	Twp 9
24	19	20	21	22	23	24	
13	18	17	16	15	14	13	
12	7	8	9	10	11	12	
1	6	5	4	3	2	1	

**VIRDEN LODGEPOLE C POOL  
05 59C**

Rge 25 WPM

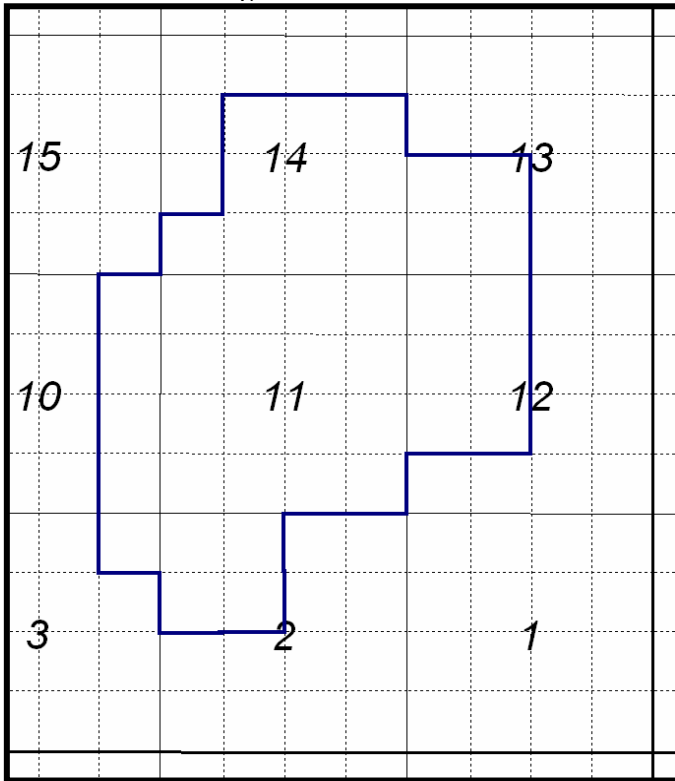

VIRDEN LODGEPOLE D POOL  
05 59D

Twp  
9

Rge 26 WPM

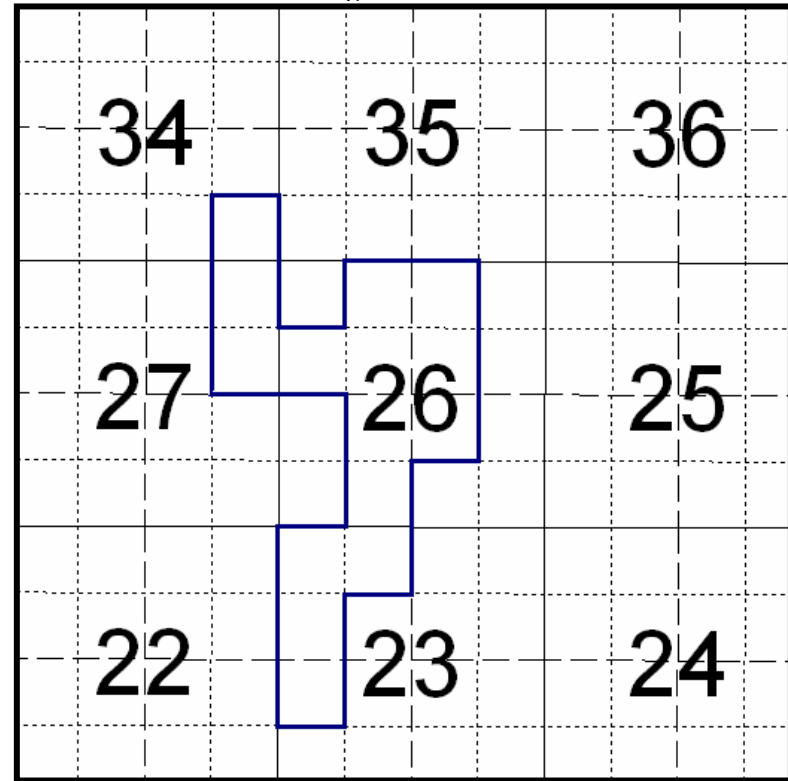

VIRDEN LODGEPOLE E POOL  
05 59E

Twp  
9

Rge 21 WPM

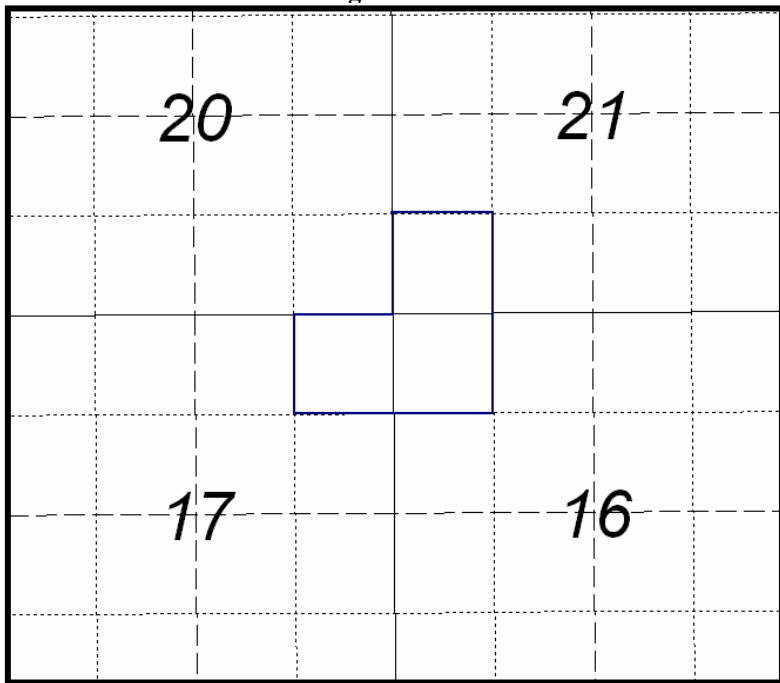

Twp  
3

WHITEWATER LOWER AMARANTH A POOL  
06 29A

Rge 21 WPM

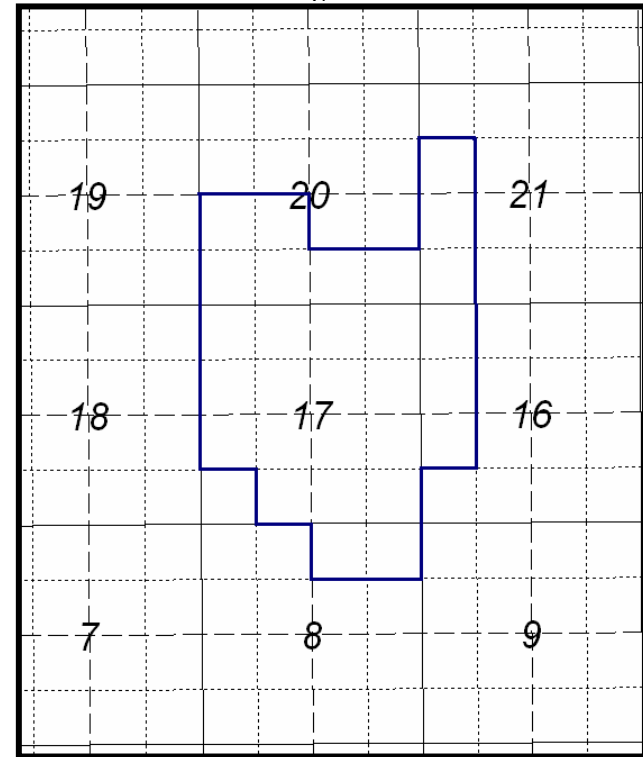

Twp  
3

WHITEWATER LODGEPOLE WL A POOL  
06 52A

**Rge 21 WPM**

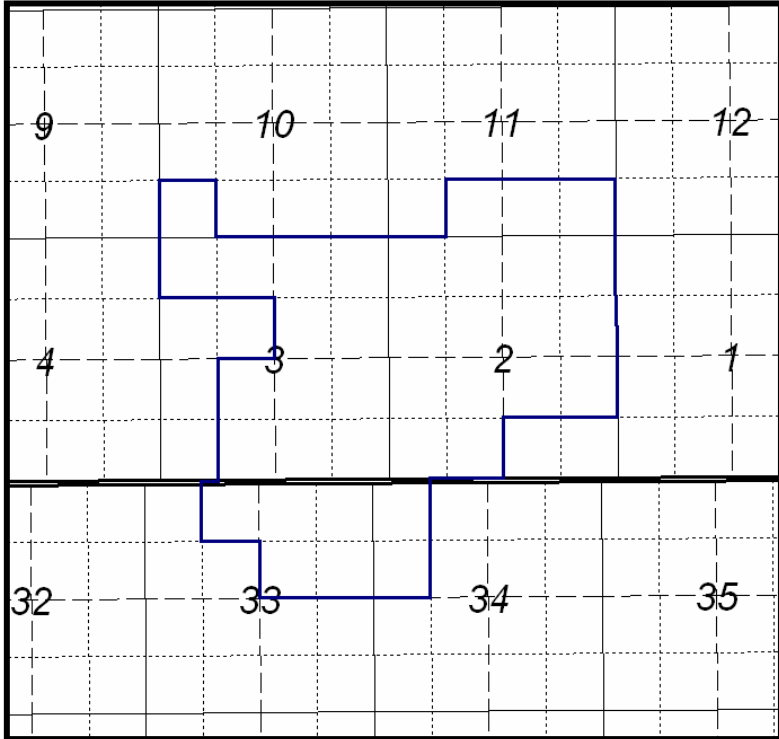

**WHITEWATER LODGEPOLE WL B POOL**  
06 52B

**Rge 21 WPM**

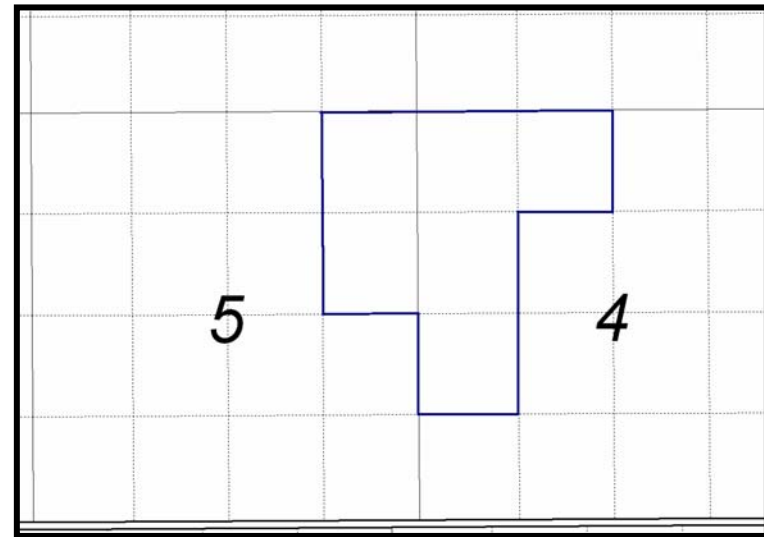

**WHITEWATER LODGEPOLE WL C POOL**  
06 52C

Rge 21 WPM

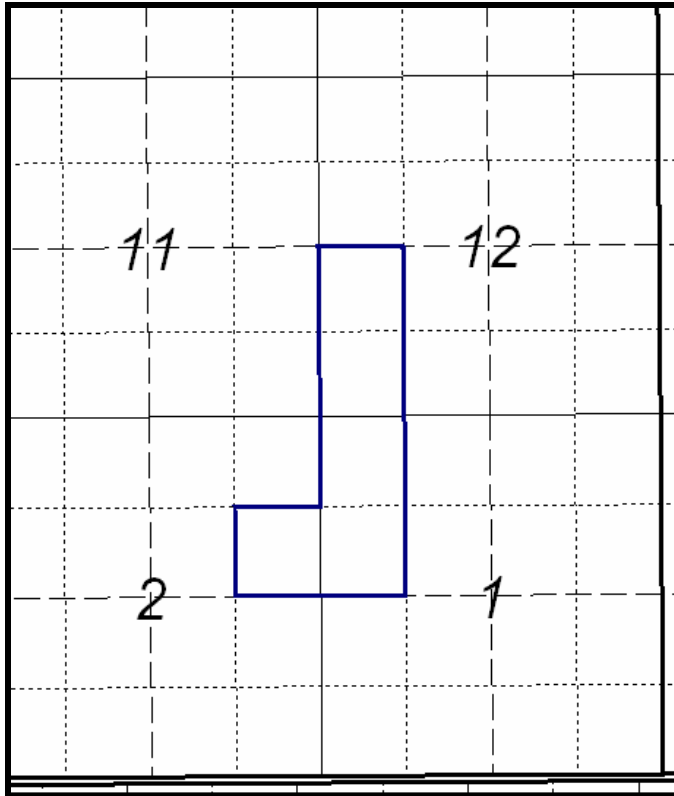

WHITEWATER LODEPOLE VIRDEN A POOL  
06 53A

Twp  
3

Rge 29 WPM

Rge 28 WPM

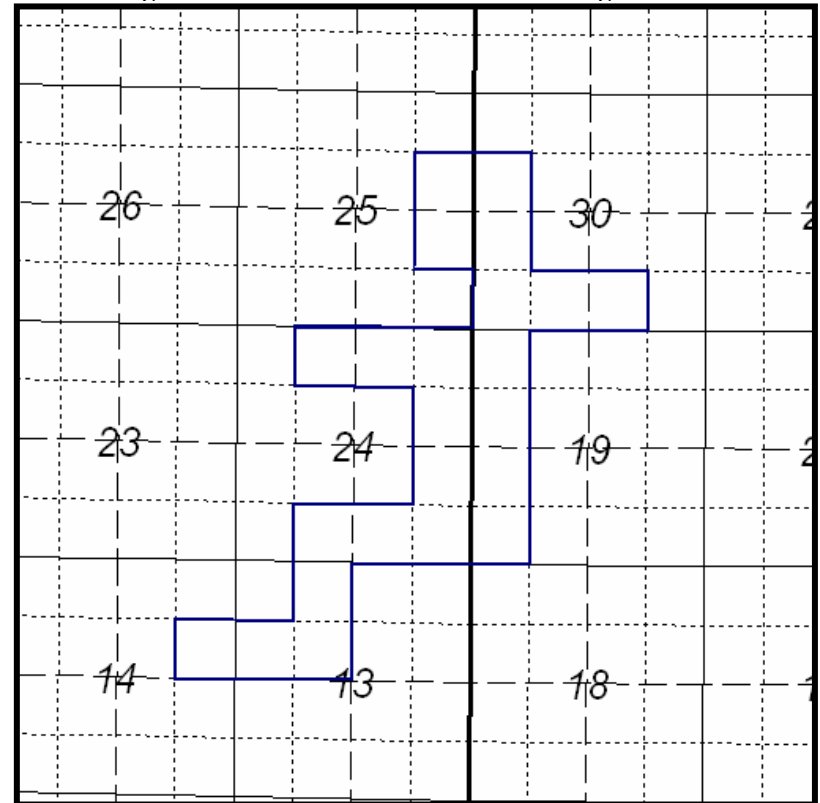

Twp  
2

PIERSON LOWER AMARANTH B POOL  
07 29 B

**Rge 28 WPM**

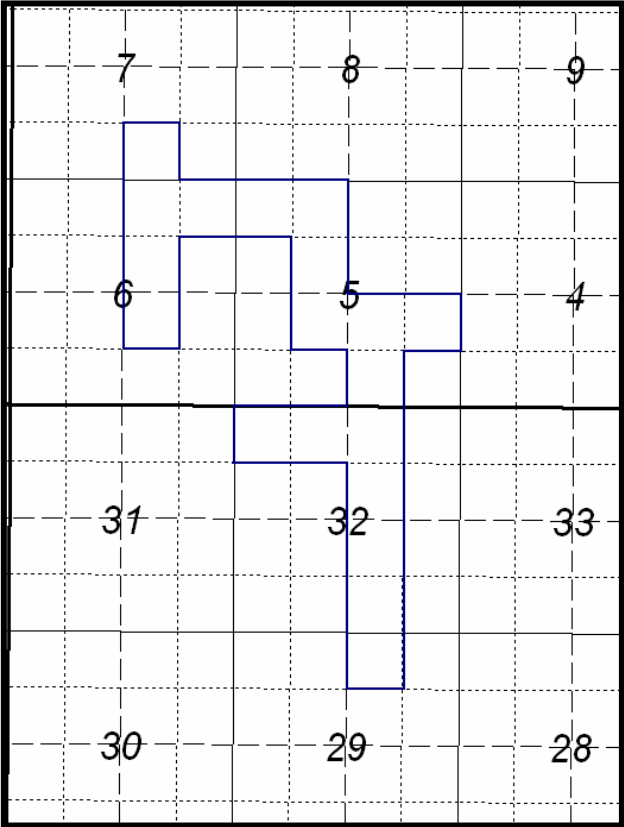

**PIERSON LOWER AMARANTH I POOL**  
07 29I

**Rge 28 WPM**

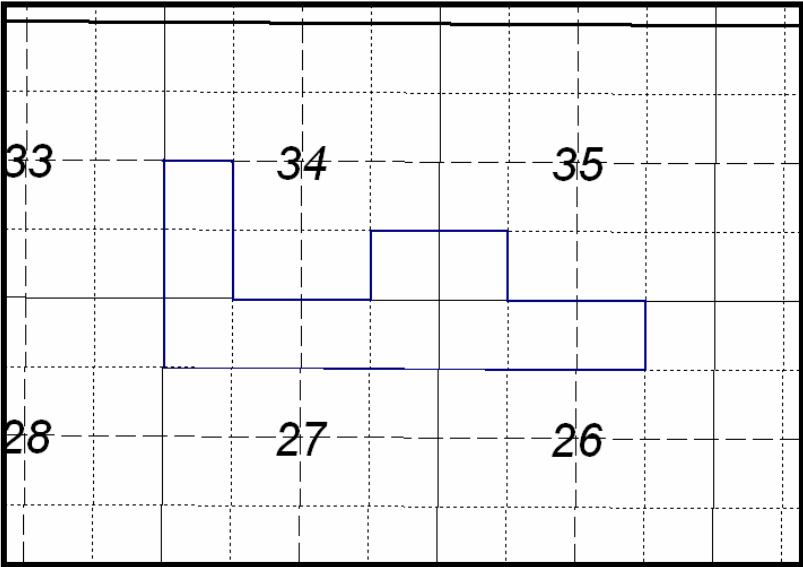

**PIERSON LOWER AMARANTH J POOL**  
07 29 J



Rge 29 WPM

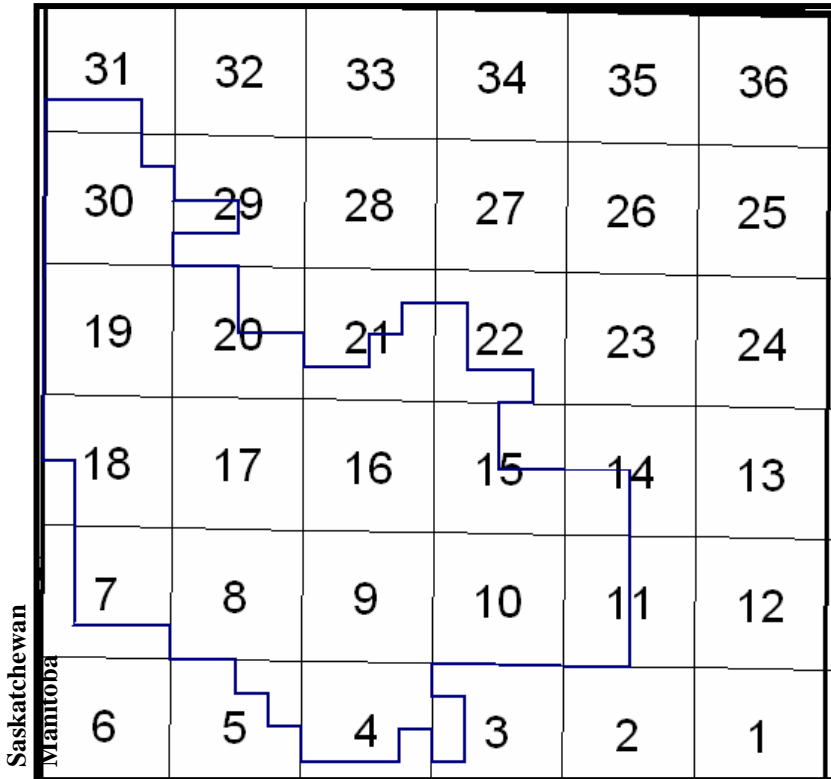

Twp  
2

Rge 28 WPM

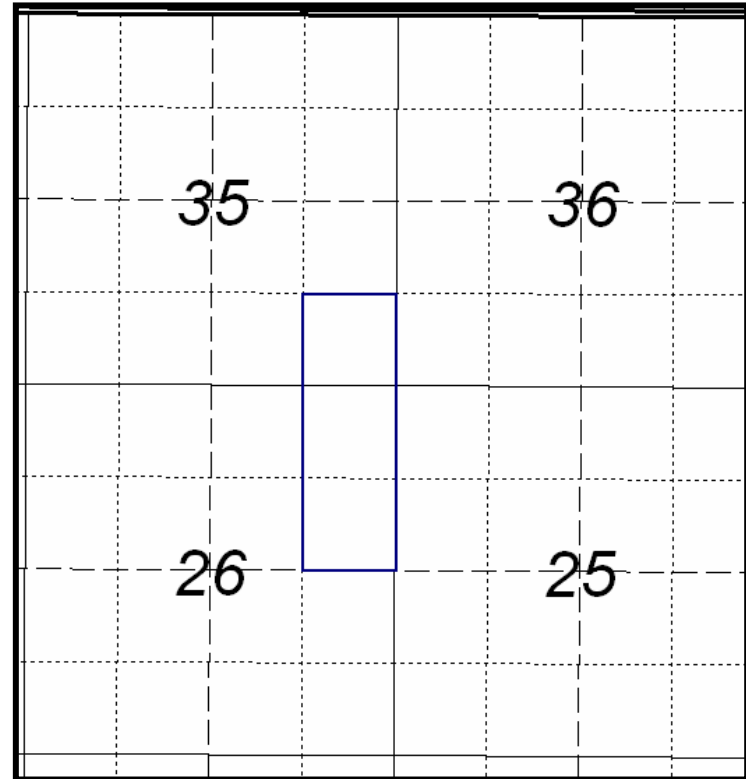

Twp  
2

PIERSON LOWER AMARANTH - MISSION CANYON 3b A POOL  
07 35A

PIERSON LOWER AMARANTH-MISSION CANYON 3b B POOL  
07 35B

Rge 29 WPM

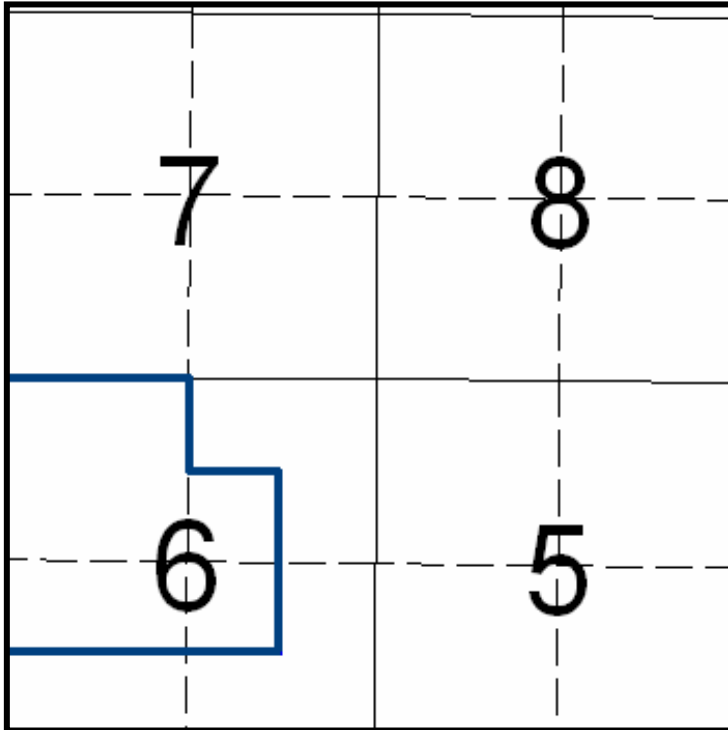

PIERSON MISSION CANYON 3C POOL  
07 41C

Rge 29 WPM

Rge 28 WPM

Twp  
3

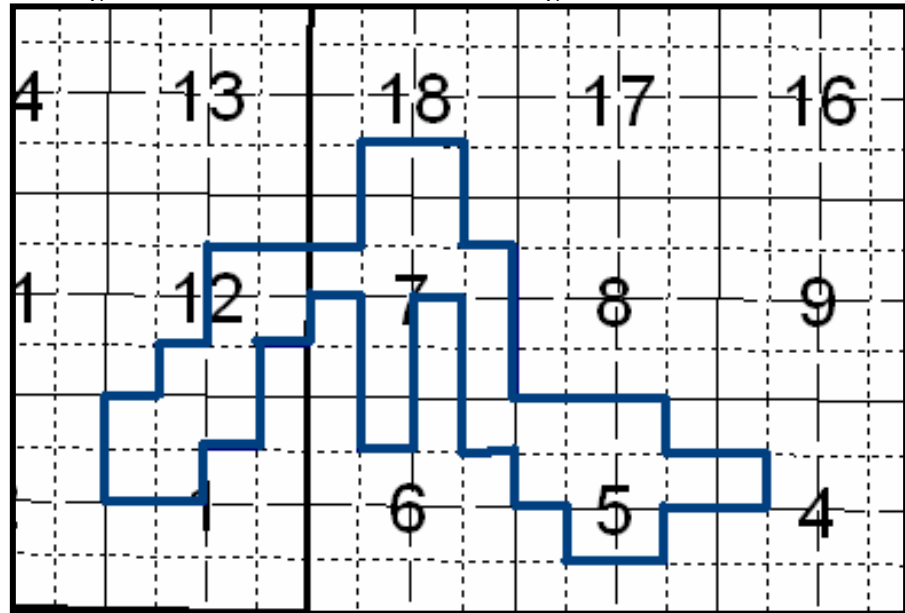

Twp  
3

PIERSON MISSION CANYON 3b B POOL  
07 42B

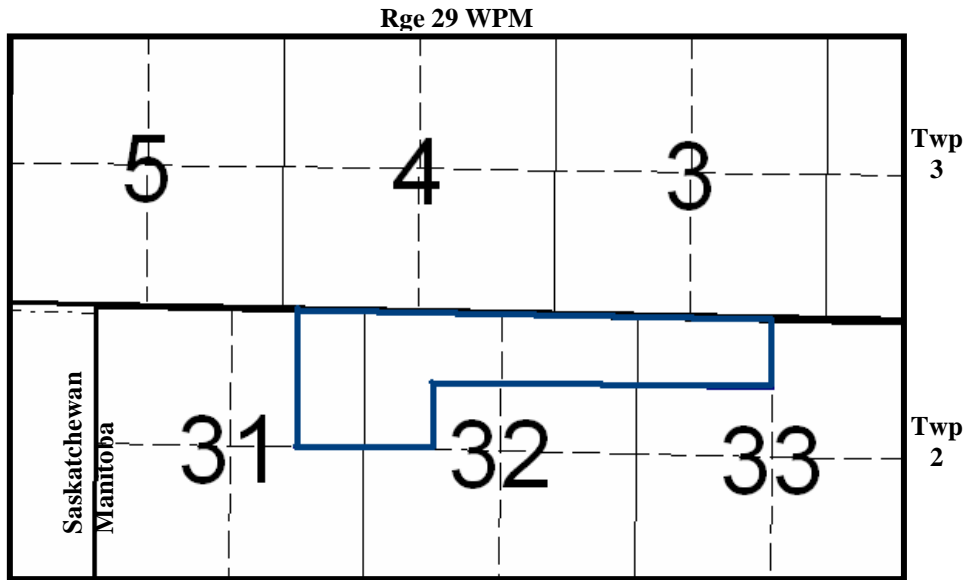

**PIERSON MISSION CANYON 3b D POOL**  
07 42D

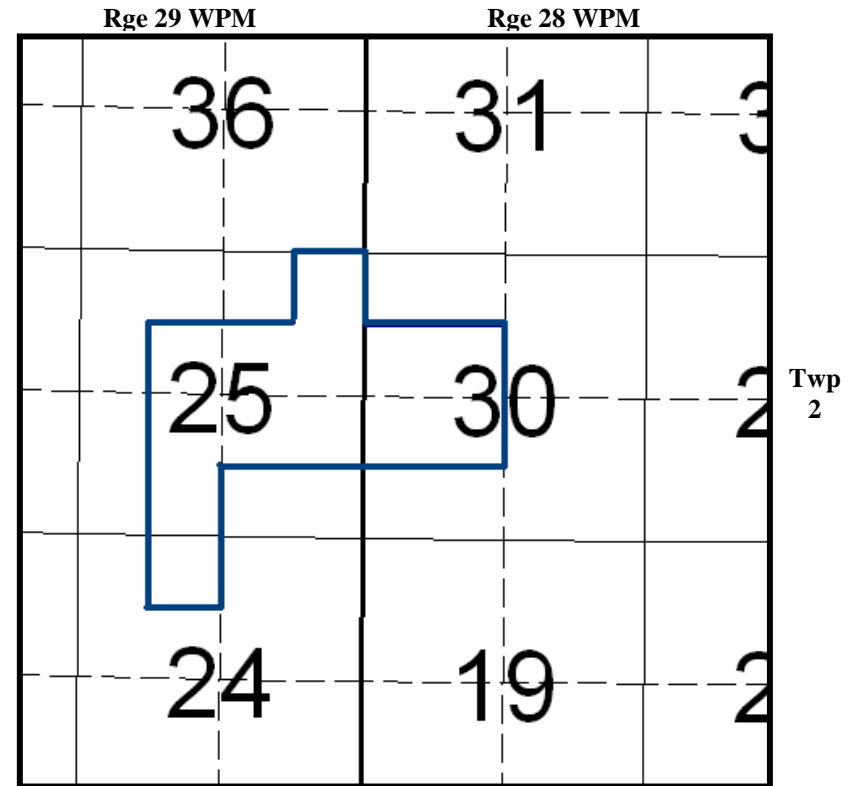

**PIERSON MISSION CANYON 3b E POOL**  
07 42E

Rge 28 WPM

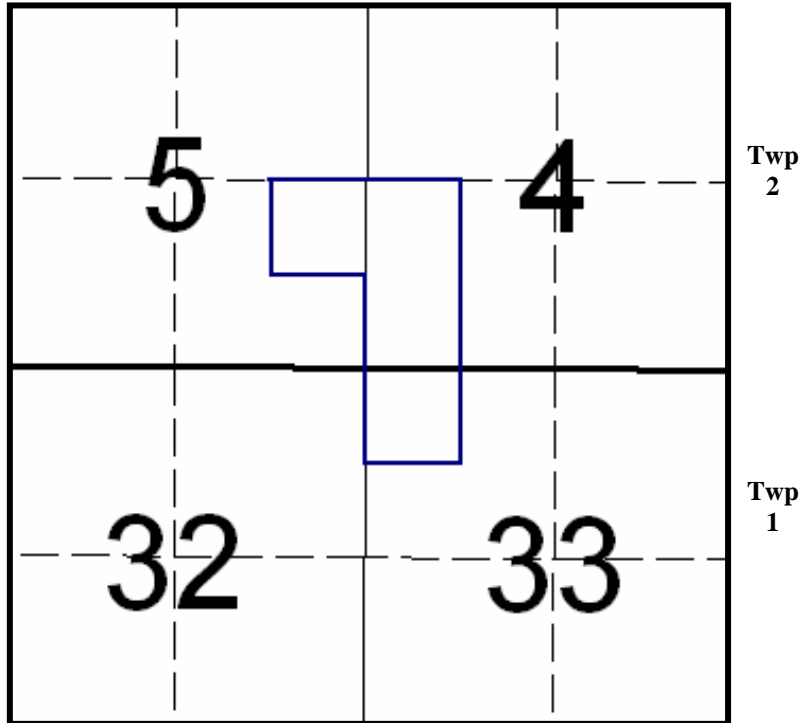

PIERSON MISSION CANYON 3b J POOL  
07 42J

Rge 29 WPM

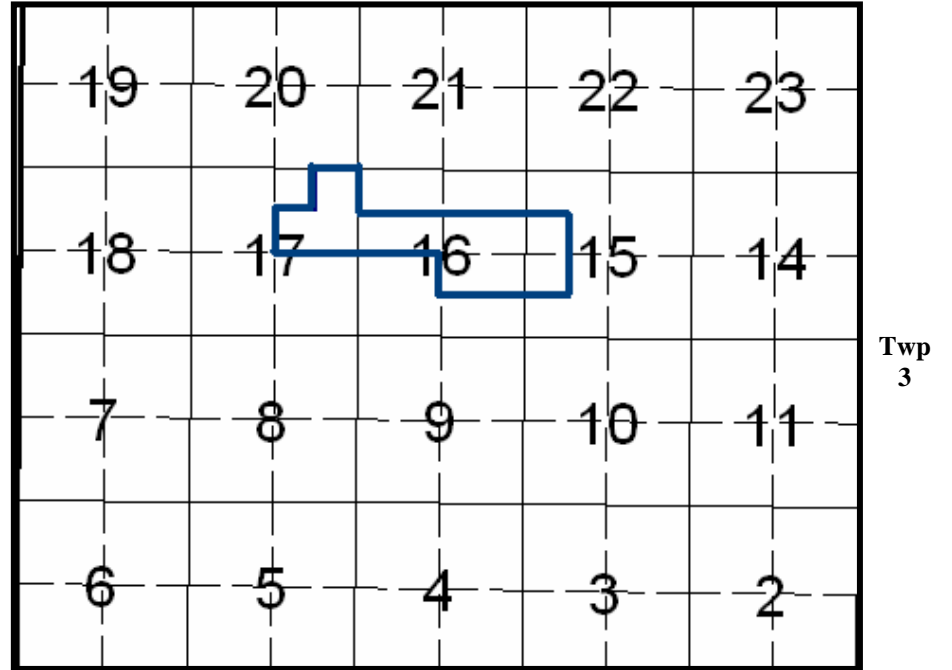

PIERSON MISSION CANYON 3a A POOL  
07 43A

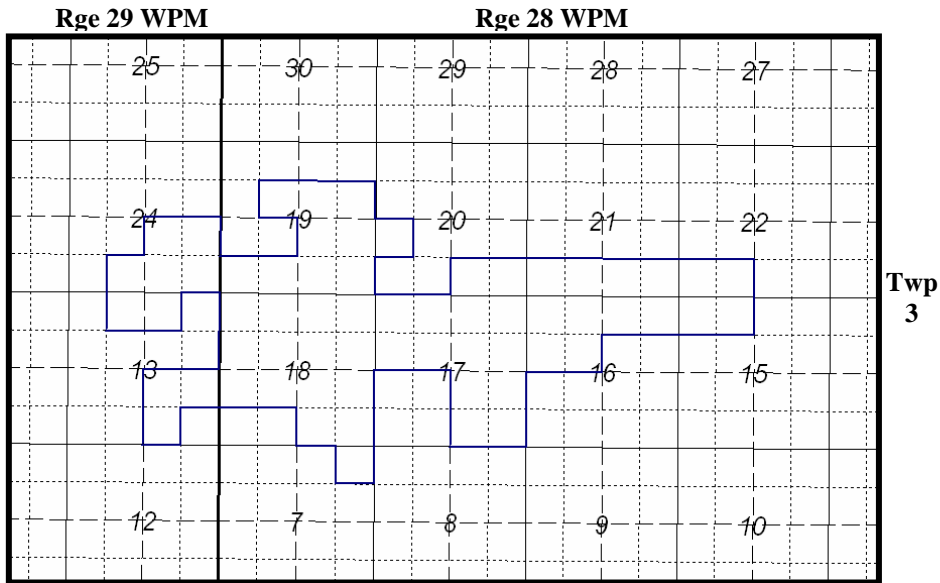

**PIERSON MISSION CANYON 3a B POOL  
07 43B**

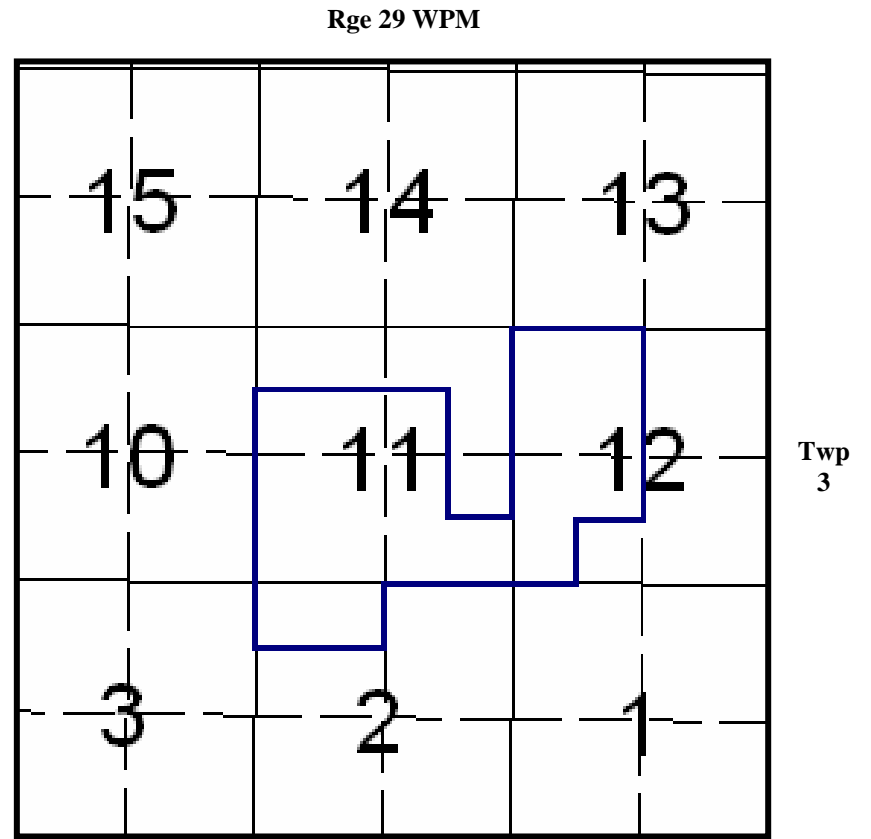

**PIERSON MISSION CANYON 3a C POOL  
07 43C**

Rge 29 WPM

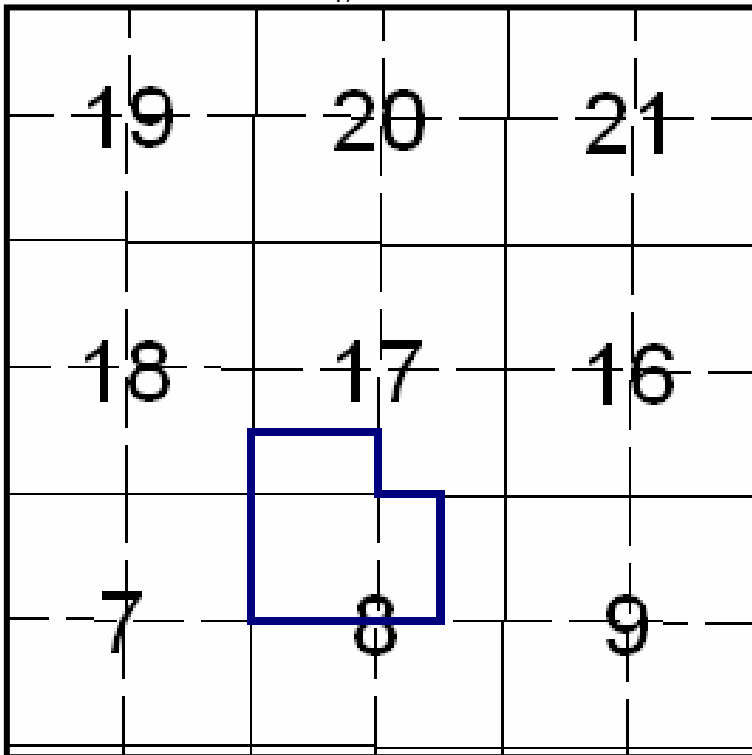

Twp  
12

KIRKELLA LODGEPOLE DOLOMITE A POOL  
09 51A

Rge 29 WPM

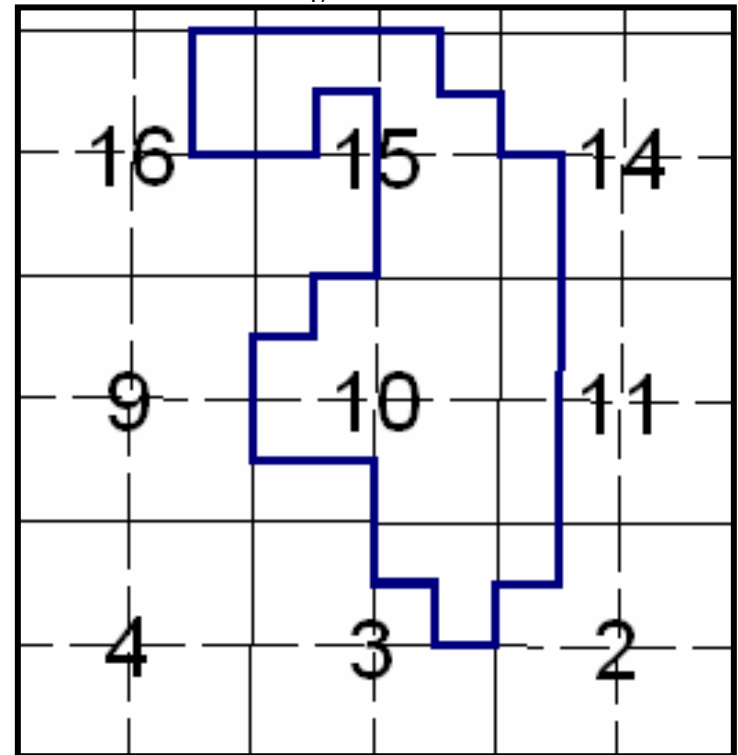

Twp  
12

KIRKELLA LODGEPOLE DALY A POOL  
09 54A

Rge 12 WPM

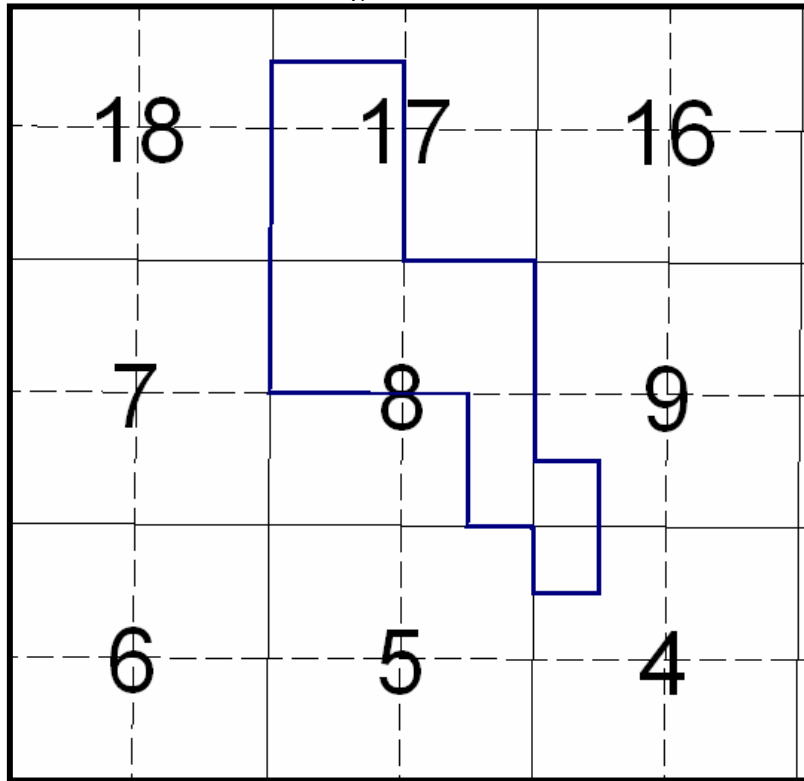

KIRKELLA LODGEPOLE DALY B POOL  
09 54B

Rge 29 WPM

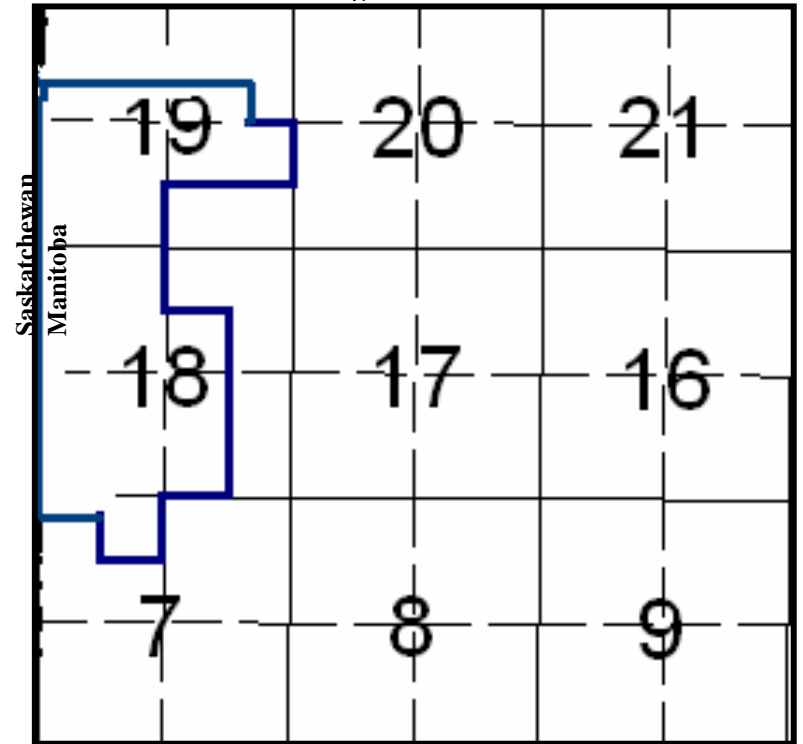

Saskatchewan  
Manitoba

Twp  
12

KIRKELLA LODGEPOLE DALY C POOL  
09 54C

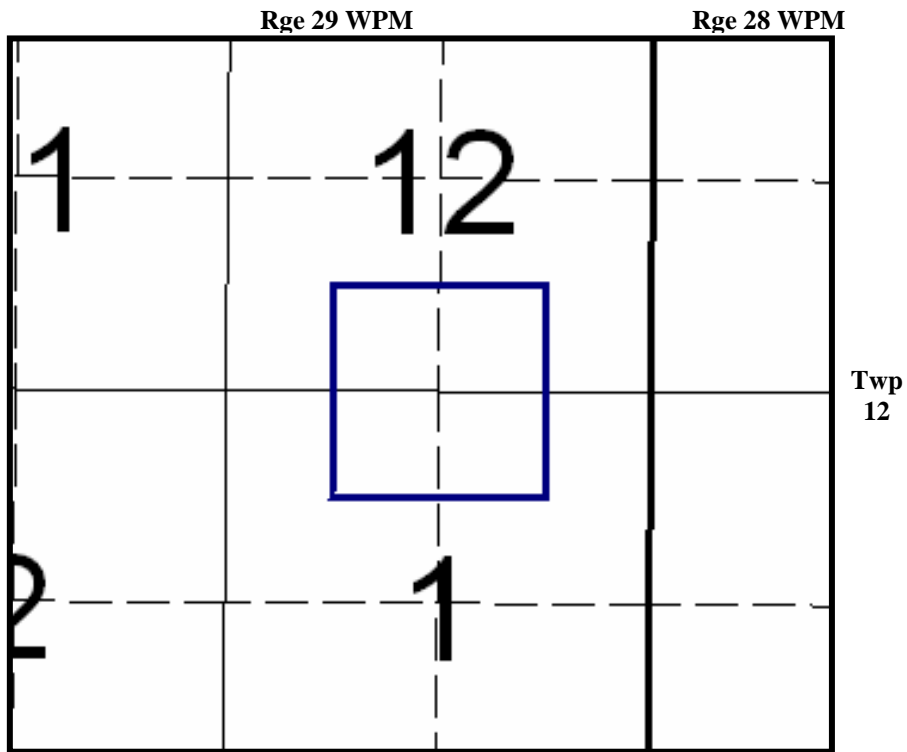

**KIRKELLA LODGEPOLE DALY D POOL**  
09 54D

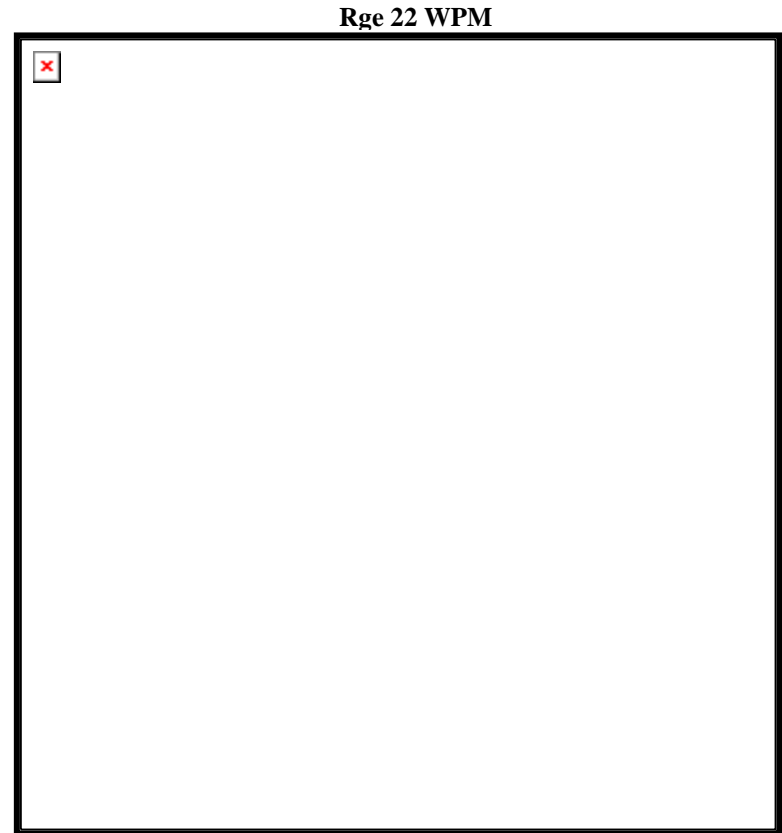

**SOURIS HARTNEY LODGEPOLE VIRDEN A POOL**  
10 53A



Rge 22 WPM

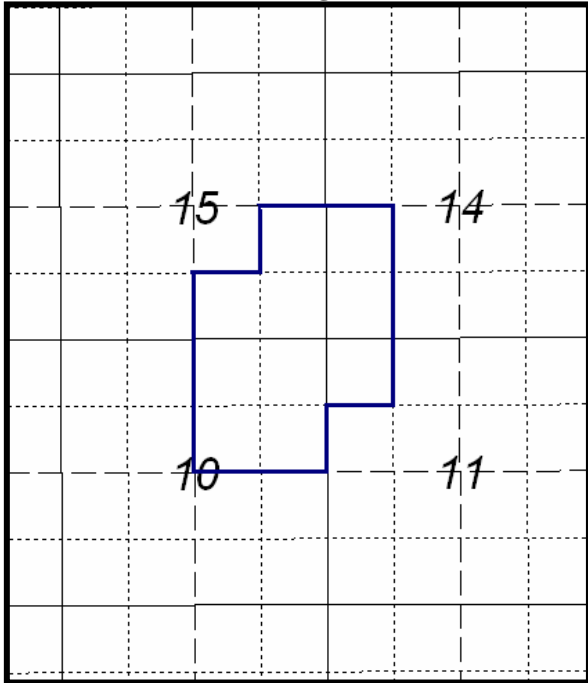

Twp  
6

SOURIS HARTNEY LODGEPOLE VIRDEN B POOL  
10 53B

Rge 27 WPM

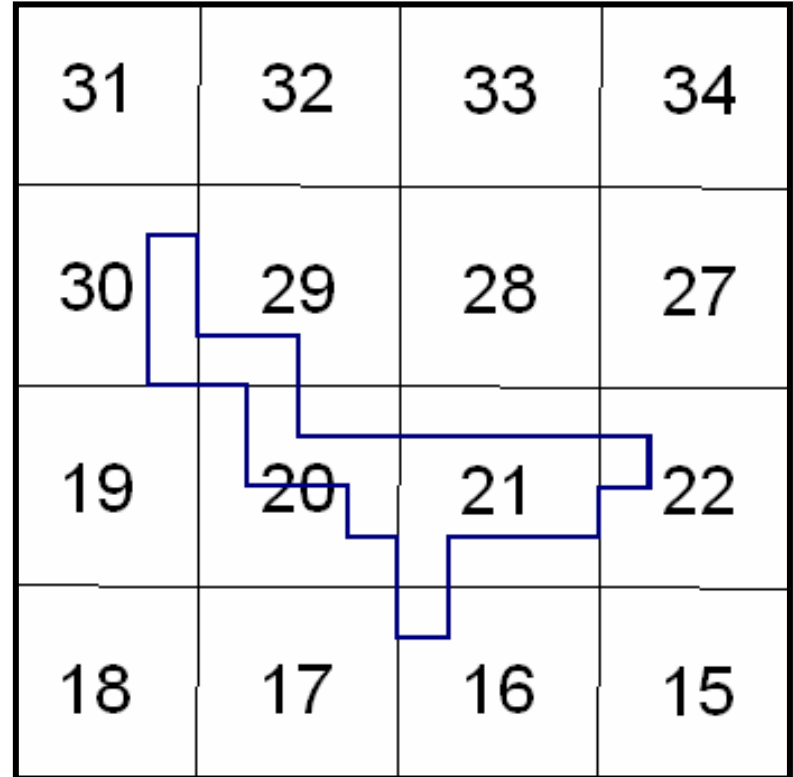

Twp  
1

COULTER LOWER AMARANTH A POOL  
11 29A

Rge 22 WPM

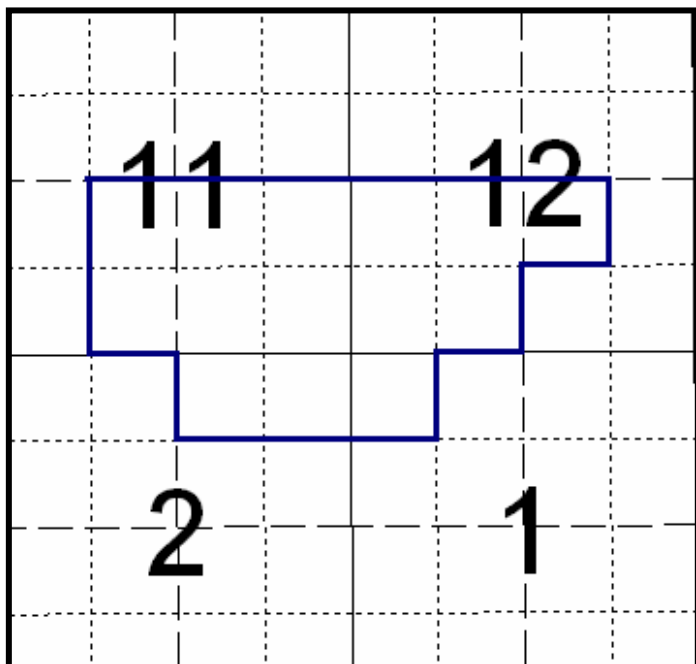

REGENT LODGEPOLE WL A POOL  
13 52A

Twp  
4

Rge 22 WPM

Rge 21 WPM

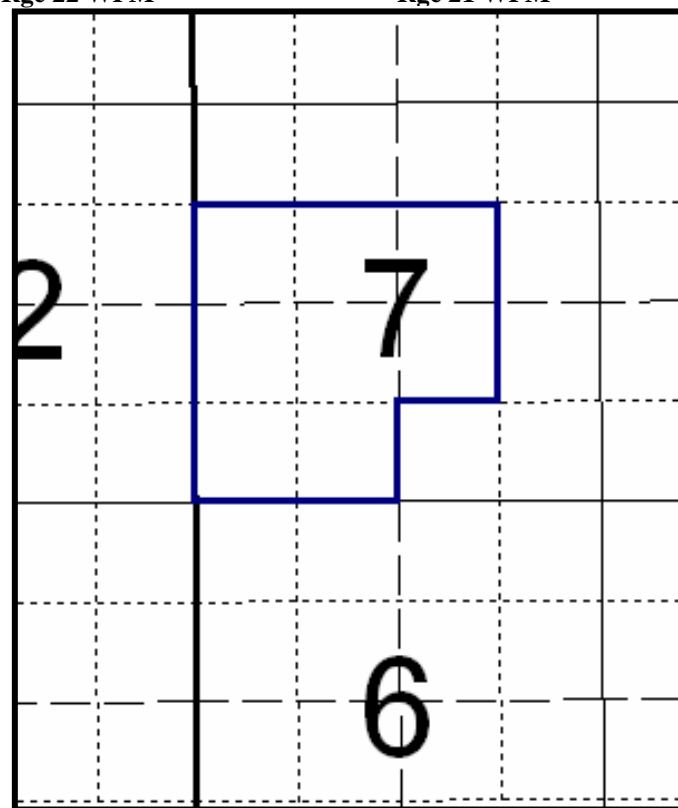

REGENT LODGEPOLE VIRDEN A POOL  
13 53A

Twp  
4

Rge 21 WPM

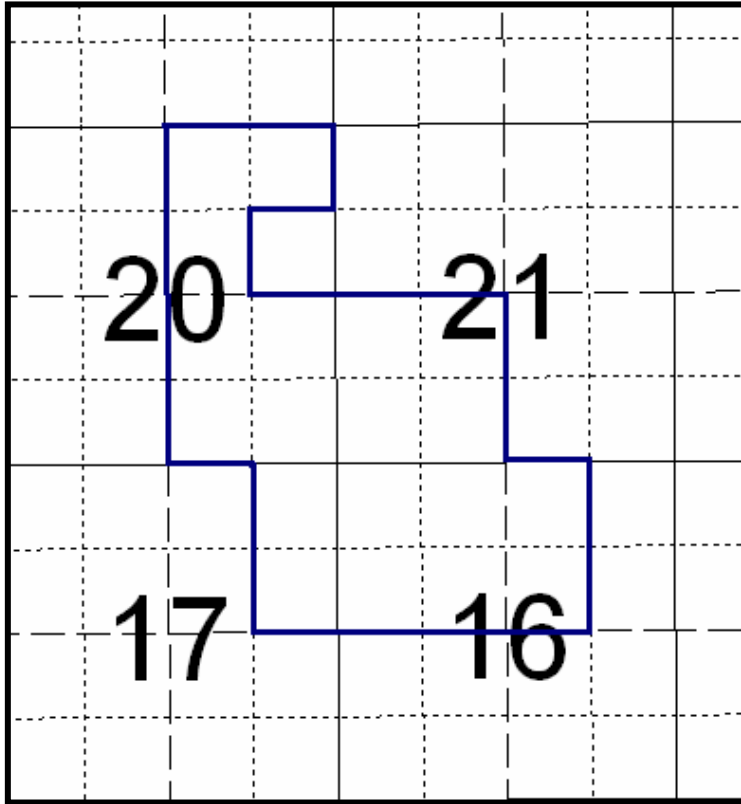

MOUNTAINSIDE LODGEPOLE WL A POOL  
14 52A

Twp  
2

Rge 27 WPM

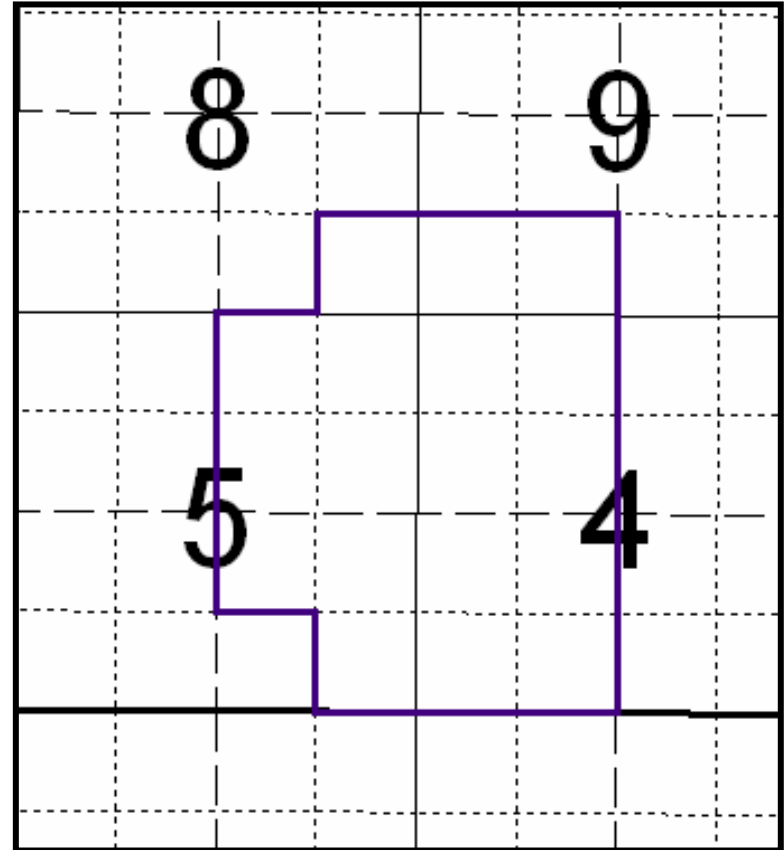

BIRDTAIL BAKKEN A POOL  
15 60A

Twp  
16

Twp  
15

Rge 27 WPM

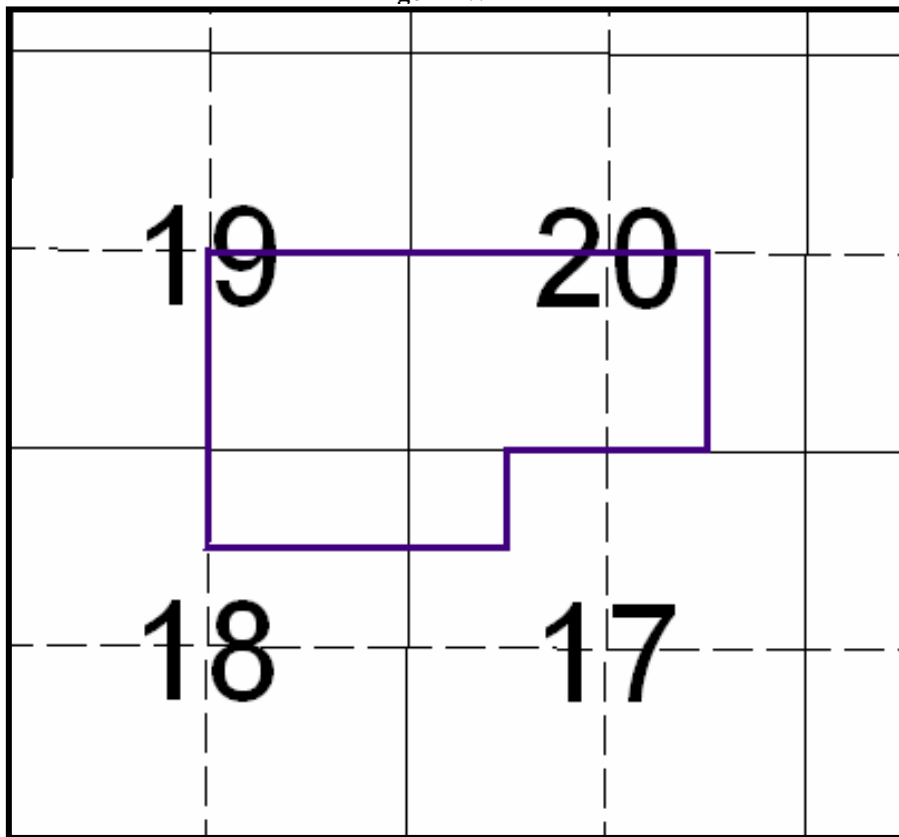

BIRDTAIL BAKKEN C POOL  
15 60C

Twp  
16

Rge 29 WPM

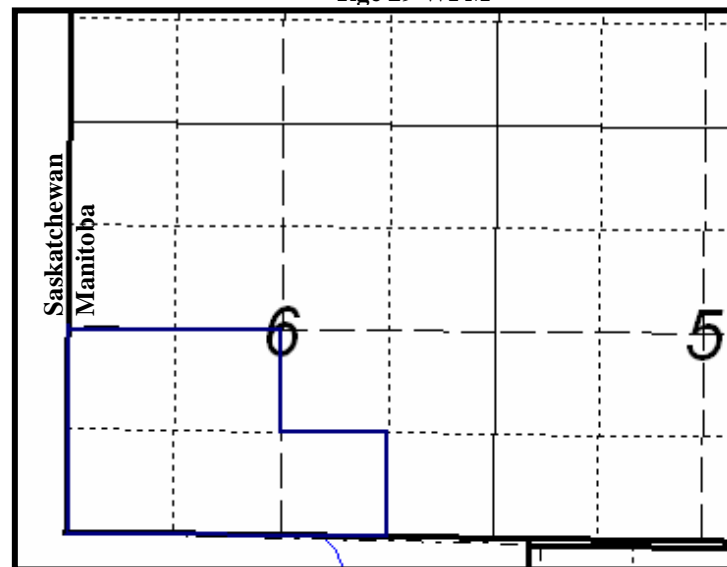

Saskatchewan  
Manitoba

Twp  
7

SINCLAIR BAKKEN-THREE FORKS A POOL  
16 62A

**Rge 29 WPM**

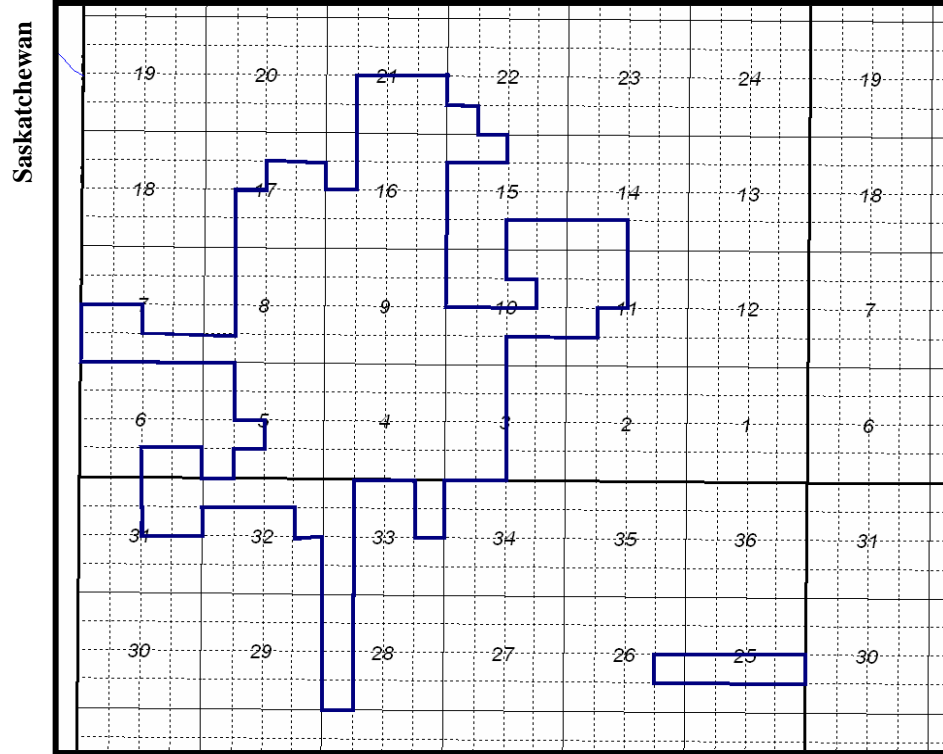

**SINCLAIR BAKKEN-THREE FORKS B POOL  
16 62B**

**Rge 29 WPM**

**Rge 28 WPM**

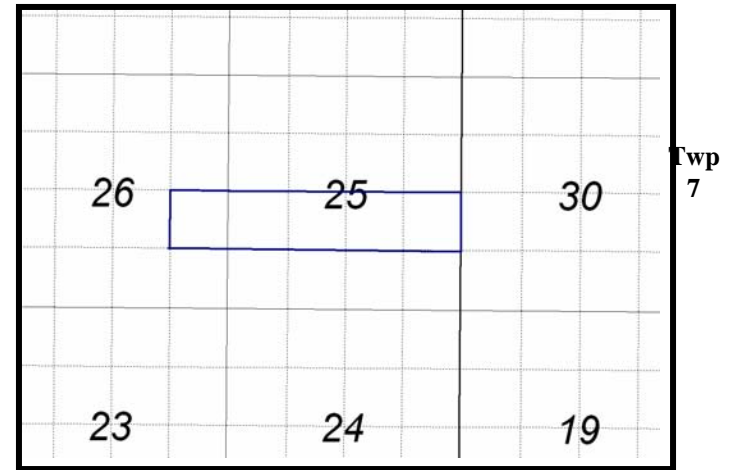

**SINCLAIR BAKKEN-THREE FORKS H POOL  
16 62H**

Rge 23 WPM

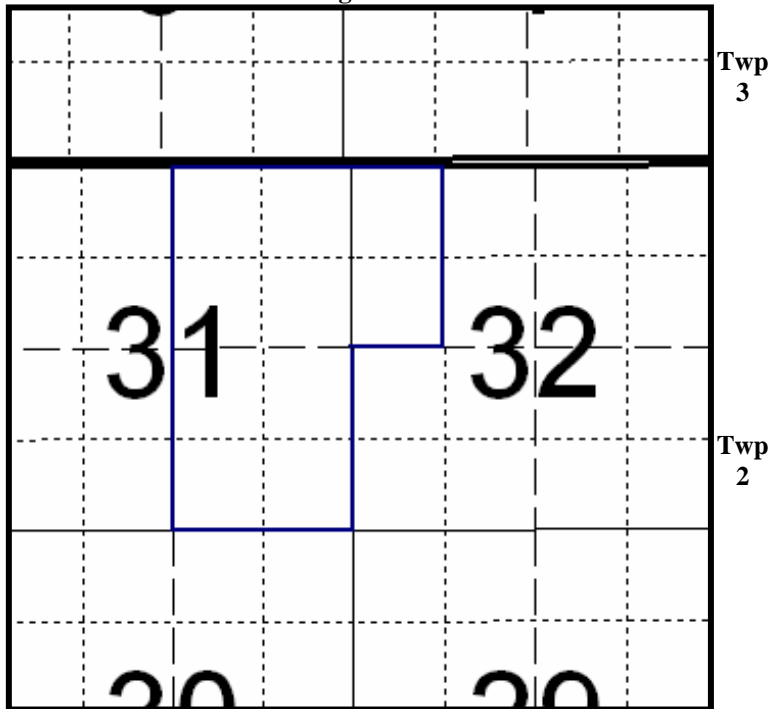

MISSION CANYON 1A POOL  
99 44A

Rge 28 WPM

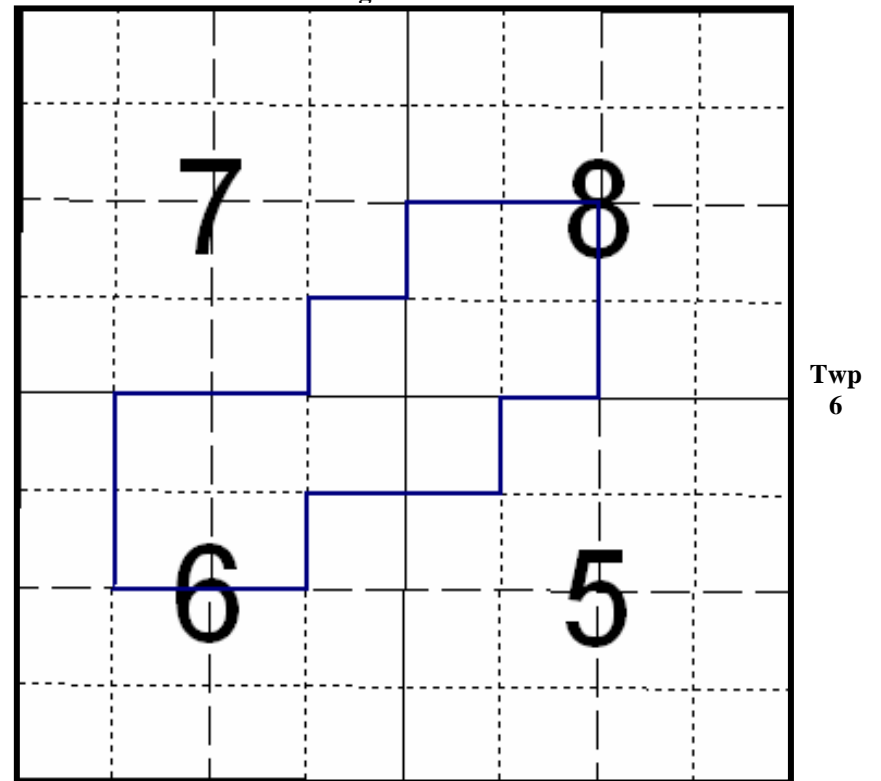

MISSION CANYON 1 E POOL  
99 44E

Rge 26 WPM

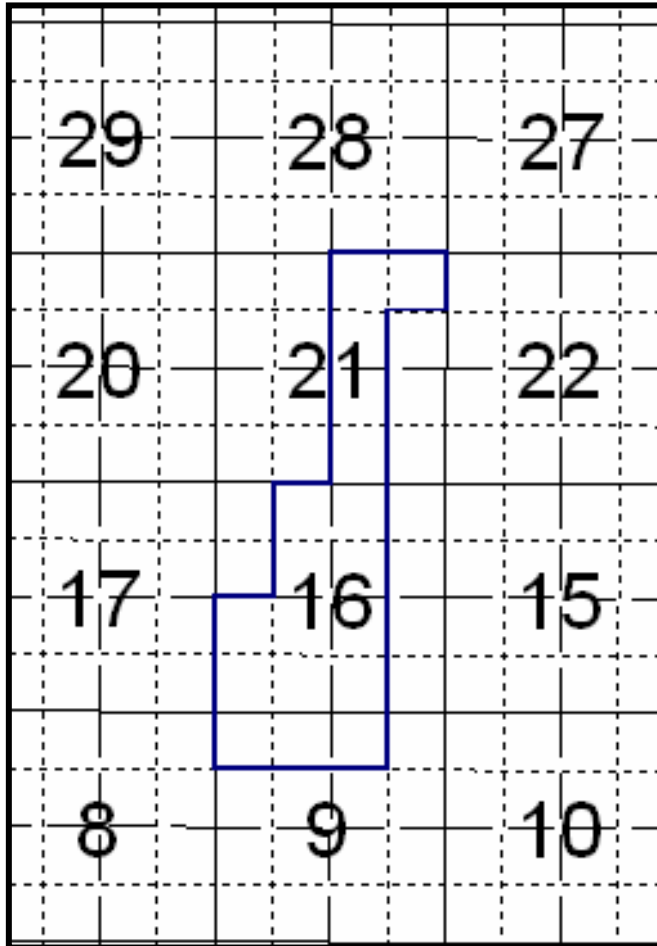

MISSION CANYON 1 G POOL  
99 44G

Twp  
6

Rge 27 WPM

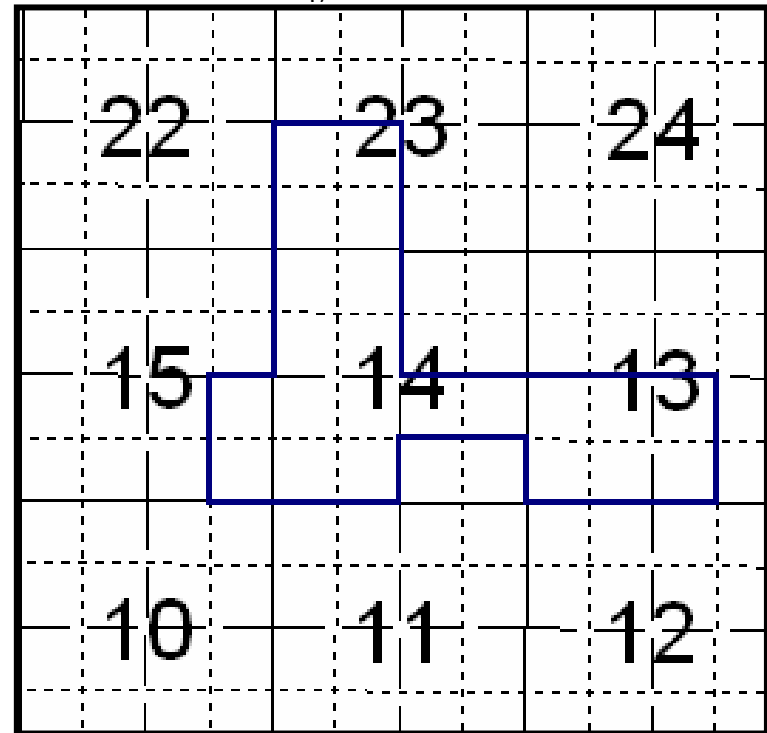

MISSION CANYON 1 H POOL  
99 44H

Twp  
6

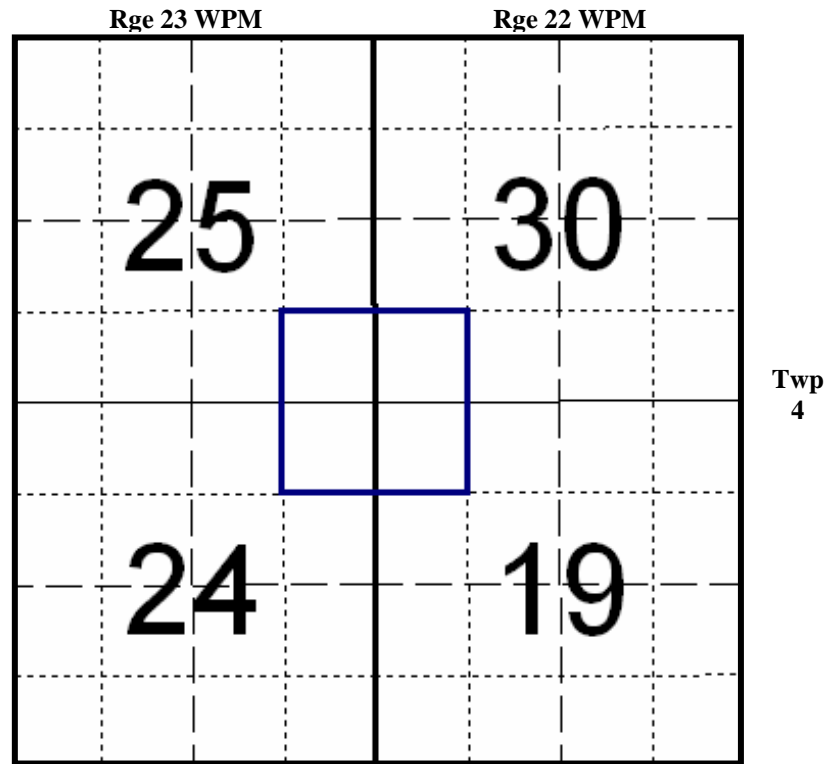

LODGEPOLE WL C POOL  
99 52C



## APPENDIX A

### Manitoba Pool Codes

<u>Code</u>	<u>Formation or Member</u>	<u>Code</u>	<u>Formation or Member</u>
11	Ashville, Viking	59	Lodgepole, undifferentiated
15	Swan River	60	Bakken
19	Jurassic, Melita	62	Bakken – Three Forks
29	Lower Amaranth, undifferentiated	65	Three Forks
35	Lower Amaranth – Mission Canyon, MC3b	71	Birdbear
39	Mississippian Undifferentiated	72	Duperow
40	Lower Amaranth – Lodgepole undifferentiated	73	Souris River
41	Mission Canyon, MC-3 undifferentiated	74	Dawson Bay
42	Mission Canyon, MC-3b	75	Prairie Evaporite
43	Mission Canyon, MC-3a	76	Winnipegosis (formerly 75)
44	Mission Canyon, MC-1	78	Devonian, undifferentiated (formerly 79)
49	Mission Canyon, undifferentiated	79	Silurian, Interlake
51	Lodgepole, dolomitic	80	Stonewall
52	Lodgepole, Whitewater Lake	81	Stony Mountain
53	Lodgepole, Virden	82	Red River
54	Lodgepole, Daly	85	Winnipeg
55	Lodgepole, Crinoidal Cruickshank)	89	Ordovician, undifferentiated
56	Lodgepole, Scallion (formerly 55)	90	Cambrian, Deadwood

January 1, 2006