

# Fish Safe



A Handbook for Commercial Fishing and Aquaculture

# Fish Safe

A Handbook for Commercial Fishing and Aquaculture

© Nova Scotia Fisheries Sector Council, 2004

This book was prepared by an advisory committee led by the Nova Scotia Fisheries Sector Council and published through Communications Nova Scotia.

Advisory committee participants:

Nova Scotia Department of Environment and Labour  
Nova Scotia Department of Agriculture and Fisheries  
Nova Scotia Safety Council  
Nova Scotia Community College, School of Fisheries

Financial or In Kind Contributors:

Transport Canada  
Nova Scotia Department of Environment and Labour  
Nova Scotia Department of Agriculture and Fisheries  
Nova Scotia Fisheries Sector Council.

Special thanks to all those who helped with the content for this handbook, particularly those industry representatives who invited our researchers to tour fishing vessels and aquaculture sites. Your wisdom and hospitality are much appreciated.

Editor: Diane MacGregor, Communications Nova Scotia

Designer: Kathy Kaulbach, Paragon Design Group

Illustrator: Jane Gallinaugh

ISBN 0-88871-842-X

## Table of Contents

Introduction .....	1
Know the Risks, Share the Responsibility .....	3
Section 1: General Safety .....	7
Use Safe Procedures .....	8
Protect Yourself from Job Hazards .....	18
Equipment Hazards and Safety Procedures .....	34
Keep Alert to Weather Hazards .....	45
Protect Your Boat from Fire .....	48
Know First Aid and CPR .....	51
Section 2: Fishing Safety .....	53
Trap Fishing .....	54
Scallop Dragging .....	62
Trawling .....	66
Seining .....	71
Gillnetting .....	77
Long Lining .....	82
Section 3: Aquaculture .....	87
Aquaculture Safety .....	88
Common Aquaculture Hazards .....	95
For More Information .....	108



## Introduction

**T**he sea is in our blood. Nova Scotia has a long, rich history in the fishery. Make no wonder. We are nearly surrounded by the sea. We have over 1600 kilometres of coastline—6500 if you enter every harbour, cove, and inlet. And nowhere in our province can you get more than 60 kilometres from salt water.

But our blood is also in the sea. Our history has many a sea tragedy. Hundreds of boats. Thousands of lives. But the real tragedy is the number of boats and lives that could—and should—have been saved. We can do better.

We must work together to improve our safety record. About 15,000 Nova Scotians work on the water in fisheries and aquaculture. We work from thousands of docks, piers,

and wharfs. We work on boats of every size and description, from small skiffs to large trawlers. And every time we leave the shore we put our lives at risk. We depend on our boats, our equipment, our experience, and each other to keep us safe. We depend on our rescue systems when we get in trouble.

This handbook is all about staying out of trouble when we can and being prepared for trouble when it comes anyway.

Read it.  
Learn it.  
Use it.  
And **WORK SAFELY.**

## Words used in this handbook

Many terms in the fishing and aquaculture industries can be used interchangeably, with little or no difference in the meanings. For the purpose of this handbook, the following terms may be used for the same purpose, despite the technical differences that may be associated with each one:

- **Quay, dock, pier, wharf, jetty, landing.** The handbook will use the terms dock and wharf.
- **Crew member, worker, co-worker, person, fisher.** The handbook may use all of these terms depending on the context, but most often will speak directly to the reader.
- **Vessel or boat.** For the purposes of the handbook, vessel will refer to larger boats usually used in seining, dragging, or trawling operations.
- **Hoist, crane, boom, derrick.** A boom is part of a hoist, crane, or derrick.
- **Captain, owner, supervisor, mate, manager, operator.** The handbook may use all of these terms depending on the context, but most often will speak directly to the reader.

**T**housands of Nova Scotians have lost their lives over the years in the fishing and aquaculture industries. Countless others have been injured.

Fishing is one of the most dangerous occupations. The leading cause of death is drowning.

Many of the tragedies in the past were unavoidable. But now we have sophisticated navigation systems, we can accurately predict weather patterns, we have a range of personal protective equipment, we have organized rescue procedures, and we have advanced communication systems.

These technological advances within the fishing and aquaculture industries have reduced injuries and fatalities. Even still, we can do better. By following simple procedures, using equipment properly, and being aware of the dangers, we can prevent many more injuries and deaths.

## ■ Drowning

Any event that lands you in the water can result in drowning:

- Falling over the side of a boat or barge while reaching for a net or line.
- Falling over the side when filling buckets while the boat is steaming ahead.
- Falling between a boat and a wharf while boarding.
- Getting caught in the gear under the water.
- Getting knocked overboard in a storm or gale.



## ■ Hypothermia

Another problem with landing in the water is hypothermia, which can occur within minutes. The waters of the North Atlantic are frigid, even during the summer months. In cold water your body loses heat rapidly, eventually shutting down all body functions. Heat is lost most rapidly through the head, sides of the chest, armpits, and groin.

## ■ Heat-related injuries

Exposure to the heat and sun during the hot summer months causes many problems on the water. Protect yourself from the hazards of heat and direct sunlight by wearing a hat, sunscreen, and sunglasses. Also, drink lots of water and take frequent short breaks.

## Survival Tip

If you have fallen overboard in frigid waters assume the heat escape lessening position (HELP).

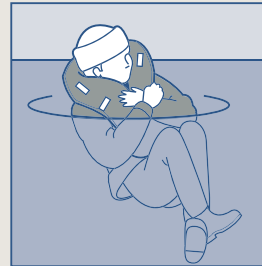

If there are two or more crew members overboard, huddle together facing inward.

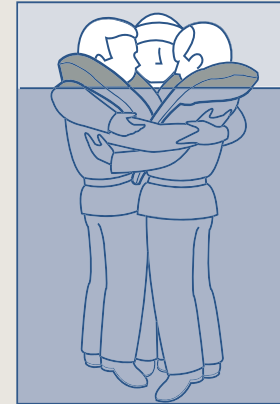

## ■ Other common injuries

- Cuts and punctures from knives, hooks, and the spines and horns of fish.
- Rope burns on the hands.
- Dislocated and amputated fingers.
- Eye injuries from hooks, spikes, sand, and wire.
- Back problems from improper lifting techniques.
- Hearing loss from long-term exposure to noisy engines.
- Electric shock.
- Burns.
- Exposure from the cold weather—even in summer.

Avoid these injuries by using the proper procedures and personal protective equipment and having a keen awareness of your surroundings. Also important is to avoid alcohol and other drugs that impair your abilities.

Every worker has the right to a safe and healthy workplace. The job of creating and maintaining a healthy and safe workplace falls on every fish harvester and aquaculture worker and their captains and employers, to the degree each has the authority and ability to do so. Everyone, from the captain to the newest worker hired, has a personal and shared responsibility for working together co-operatively to prevent injuries and illnesses.

Because captains and operators have the greatest degree of control over the vessels and farms, they also have the greatest degree of responsibility for health and safety. But mates, supervisors, and workers also have a duty to control workplace hazards and to take the necessary precautions to protect themselves and others from hazards.

Workers who are informed and empowered will have fewer injuries. Thus, the law grants three important rights to workers:

- The **right to know** about workplace hazards—including how to identify hazards and protect themselves from those hazards—and about the rights given to workers under the law.
- The **right to participate** in decisions related to health and safety.
- The **right to refuse** dangerous work.

The goal of this system is to get people working together to identify and control situations or hazards that could cause harm. Its ultimate objective is to ensure that everyone works safely.

What follows is directed at everyone working in the fishery. It speaks directly to the reader, inviting everyone to get involved in safety. But a large part of the legal responsibility for safety still rests with the captains, employers, and supervisors. Captains, employers, and supervisors must ensure that everyone on the boat or at the worksite

- Knows their responsibilities and how to do their tasks safely.
- Has the necessary safety equipment.
- Works safely.

## Section 1: General Safety



## Use Safe Procedures— Every Time You Leave Shore

Although there are many different types of workplaces in the fishery, many procedures are common to all boats.

### ■ Use a pre-sailing checklist

Before leaving port, make sure the boat is properly prepared. Check the following:

- Is the boat seaworthy?
- Is the equipment properly secured? Check traps, safety equipment, fishing gear, lines, ropes and cables, and boats or skiffs.
- Are the supplies properly stored? Check fuel, food, and cleaners.
- Are the radio and other communication devices functioning properly?
- Have you prepared and submitted your float plan?

### Pre-Sailing Checklist

Date: \_\_\_\_\_ Vessel: \_\_\_\_\_

- |   |  |
|---|--|
| <input type="checkbox"/> All Crew Accounted For             | <input type="checkbox"/> Inflatable Life Rafts   |
| <input type="checkbox"/> Stores                             | <input type="checkbox"/> Immersion/Floater Suits |
| <input type="checkbox"/> Fuel (Motor)                       | <input type="checkbox"/> Life Jackets            |
| <input type="checkbox"/> Oil                                | <input type="checkbox"/> Lifeboats               |
| <input type="checkbox"/> Gas                                | <input type="checkbox"/> Flares                  |
| <input type="checkbox"/> Spare Equipment                    | <input type="checkbox"/> Fire Extinguishers      |
| <input type="checkbox"/> Bonded Stores (If Applicable)      | <input type="checkbox"/> SCBA/SCUBA              |
| <input type="checkbox"/> Machinery in Good Working Order    | <input type="checkbox"/> EPRIBs                  |
| <input type="checkbox"/> Pumps in Good Working Order        | <input type="checkbox"/> Handheld VHF            |
| <input type="checkbox"/> First Aid Kits                     | <input type="checkbox"/> SART                    |
| <input type="checkbox"/> Float Plan Left with Shore Contact |  |
| <input type="checkbox"/> Log Books                          |  |

Describe any work done while the vessel was in port:

---



---



---



---



---



---



---



---



---



---



---



---



---



---



---



---

## Float Plan

Telephone number of nearest RCC or MRSC.: \_\_\_\_\_

Vessel Name: \_\_\_\_\_ Home Port: \_\_\_\_\_

Colour of Hull: \_\_\_\_\_ Vessel Registration #: \_\_\_\_\_

Colour of Deck: \_\_\_\_\_ Vessel Licence #: \_\_\_\_\_

Colour of Superstructure: \_\_\_\_\_ Fishing #: \_\_\_\_\_

Length of Vessel: \_\_\_\_\_ Vessel Type: \_\_\_\_\_

# of Flares: \_\_\_\_\_ # of Life Jackets: \_\_\_\_\_

# of Immersion Suits: \_\_\_\_\_ # of Floater Suits: \_\_\_\_\_

Make and Capacity of Life Rafts: \_\_\_\_\_

Number and Description of Lifeboats: \_\_\_\_\_

Captain/Operator's Name: \_\_\_\_\_

Address: \_\_\_\_\_

Phone Number: \_\_\_\_\_ Mobile # if Fitted: \_\_\_\_\_

Radio Equipment Fitted and Frequencies Monitored:

VHF: \_\_\_\_\_ Lifeboat: \_\_\_\_\_

MF: \_\_\_\_\_ Handheld VHF: \_\_\_\_\_

MF/HF: \_\_\_\_\_ SART: \_\_\_\_\_

EPIRB: \_\_\_\_\_ Other: \_\_\_\_\_

Departure Date: \_\_\_\_\_ Time: \_\_\_\_\_

Expected Length of Trip: \_\_\_\_\_

Intended Fishing Area: \_\_\_\_\_

Proposed Route: \_\_\_\_\_

Estimated Return Date: \_\_\_\_\_ Time: \_\_\_\_\_

Number of Crew: \_\_\_\_\_

Radio Communication Schedule with the person holding this plan:

\_\_\_\_\_  
 \_\_\_\_\_

Probable Ports of Refuge: \_\_\_\_\_

If fishing with other vessels, the names of the other vessels:

\_\_\_\_\_  
 \_\_\_\_\_

## ■ Prepare and submit a float plan

Prepare a float plan to let people know where the boat will be and at what times it will be there. The boat should follow the float plan as closely as possible.

## ■ Board safely

Boats, wharves, and cages vary greatly in size and design. This makes it difficult to have a standard boarding procedure. However, there are some basic rules to follow when boarding a boat.

## Basic Rules When Boarding a Boat

**1** Always look where you are putting your hands and feet. Watch for uneven docks, rotten spots and splitters, protruding hooks and nails.



**2** Wear boots or shoes with good traction.



3 Make sure the ladders and gangways used to board the vessel are free of ice, snow, debris, and equipment.

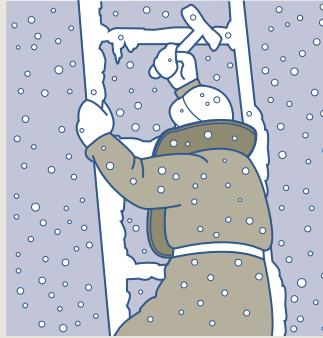

5 Try to maintain a two-hand and one-foot contact (or one-hand and two-foot contact) when boarding.



4 Make sure gangways and ladders are not missing boards or rungs.



6 Secure gangways to both the vessel's bulwark and the dock.

\* At aquaculture sites, secure the boat to the cage structure.

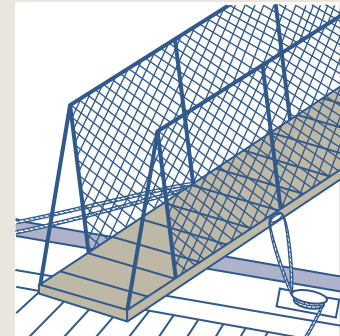



## ■ Know when and how to evacuate

As a general rule, remain on board for as long as possible. Smaller life rafts and lifeboats are harder for rescuers to find, even if they are equipped with sophisticated beacons or transmitters.

Evacuate your boat in extreme circumstances only:

- If there is an uncontrollable fire.
- If the boat is taking on too much water and is in danger of capsizing.

Everyone on board should know the evacuation procedure. **Practice is important. In an emergency, panic is a natural reaction. Training and practice reduce panic reactions.**

## Know the Evacuation Procedure

*Practice is important.  
In an emergency, panic  
is a natural reaction.  
Training and practice  
reduce panic reactions.*

- 1 The sound of the alarm.
- 2 How to sound the alarm.
- 3 Location of muster stations—where to gather together.

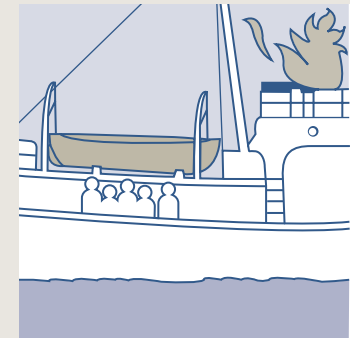
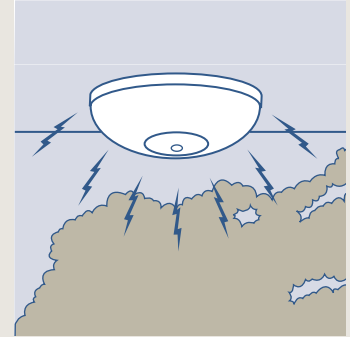

- 4 How to properly don a life jacket or immersion suit.

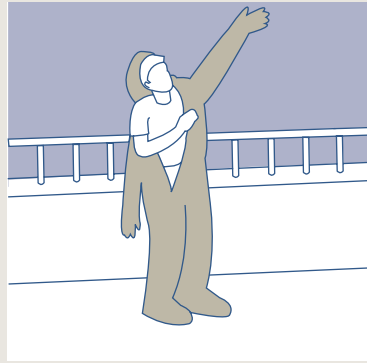

- 5 How to get into the survival craft.

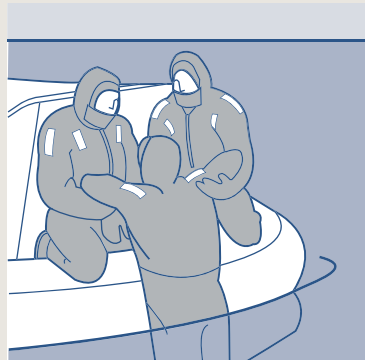

Have adequate survival craft

Survival craft include lifeboats, life rafts, or life capsules. Regulations specify what each type of boat must carry while fishing.

Lifeboat

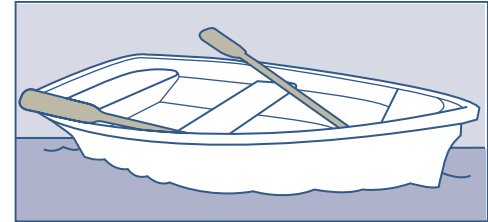

Life Raft

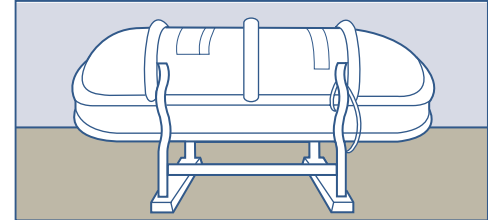

Life Capsule

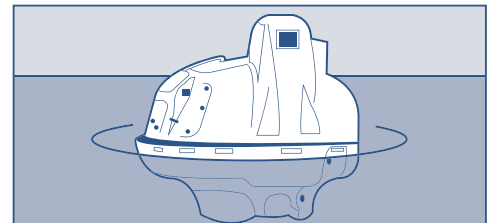

Capacity of survival craft is an issue when crewing a boat. A six-member crew requires a six-person craft. Although the raft or capsule can "hold-up" two times its rating, space is limited.

On larger boats survival craft should be available on both sides of the vessel. If the boat is listing or heeling to one side, you can get into a survival craft from the other more safely.

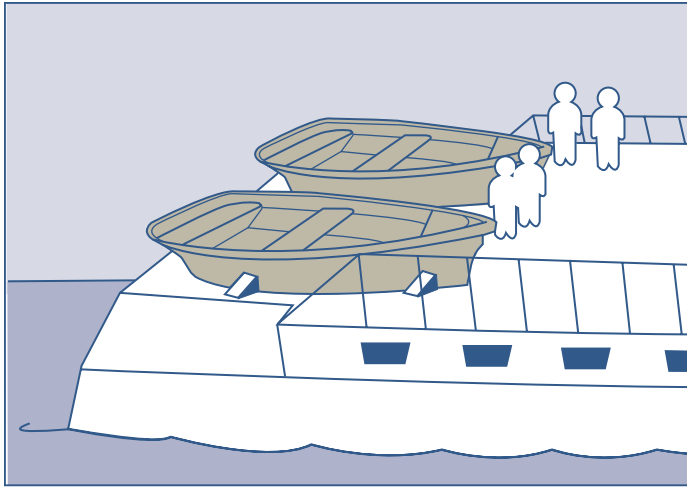

### Wear personal flotation devices

Wear a personal flotation device (PFD) when working on the main deck, where traps, nets, and other equipment are located. Newer PFDs are lightweight and designed for good mobility. You should be able to find a style that is comfortable to wear while working.



### Check that flashlight works

Keep a flashlight, in good working condition, in its own special accessible place in case of need.

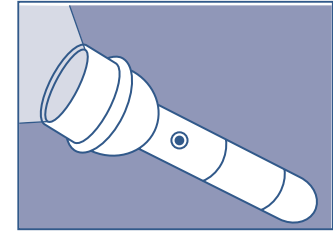

## Know how and when to use flares

Flares help rescuers find you when you are in trouble at sea. All boats must carry them. Regulations set out numbers required. Most boats are required to carry a certain number of flares, regardless of their size.

Everyone on board must know both how and when to use each type. It is important not to panic and waste the flares. Use only when a boat, ship, or aircraft is within earshot or eyesight. Once again, training is essential.

### Flare Types

Four types of flares are most commonly used in the fishing industry.

Type A Rocket parachute

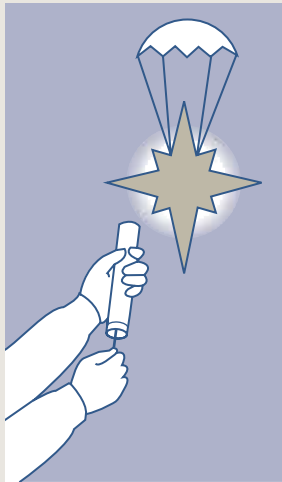

Type B Meteors

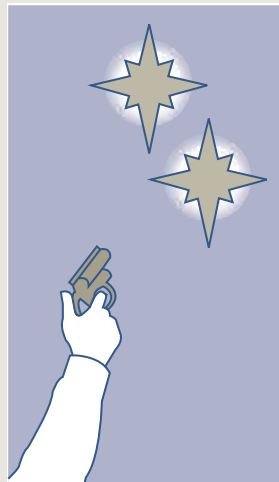

Type C Handheld



Type D Buoyant orange smoke

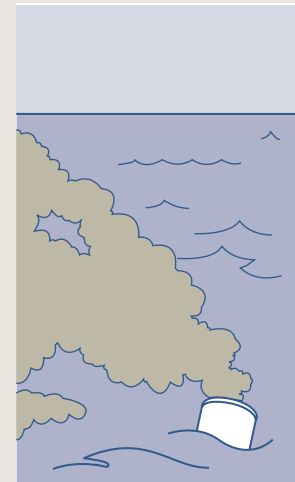

## ■ Know how to rescue someone who's fallen overboard

When someone falls overboard, they usually need help to get back on board. They will also need help quickly:

- Death by cold-water immersion can occur within minutes in the frigid waters of the North Atlantic.
- Many crew members can't swim, so if they're not wearing a PFD, they can drown in a very short time.
- They can be caught in a net or line and need help to get untangled.
- They may be knocked unconscious.

## Rescuing Man Overboard Procedure

- 1 Throw them a life jacket, life preserver, or another object that floats. These items are generally light coloured or fluorescent. This helps other crew members to better identify the location of the fallen crew member as the boat manoeuvres into a position to retrieve them.

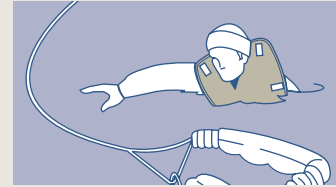

- 2 If possible, have a crew member keep a watch on the person at all times.
- 3 Inform the wheelhouse that a crew member has gone overboard.

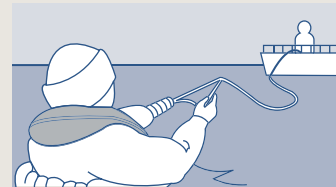

- 4 Make sure the people retrieving the crew member are not put in a position where they will fall overboard as well.

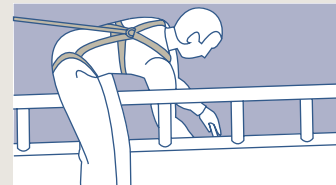

## ■ Know how to find a missing crew member

If a person falls overboard and is spotted immediately, assign someone to keep a constant watch on the stricken person while you safely manoeuvre the boat into a position to retrieve them. If a person is missing, use the Williamson turn to bring the boat back on its same track, in the reverse direction, to begin the search for the missing person.

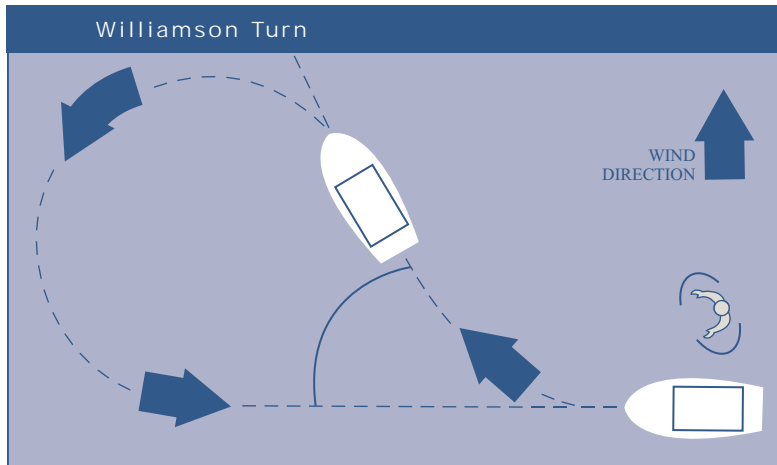

### Procedure for missing crew member

- 1 Alert everyone to be on the lookout.
- 2 Transmit a Distress to alert other boats in the area and the local rescue authorities.
- 3 Turn the boat around onto the reverse course by carrying out the Williamson turn:
  - a Put the rudder "hard over" until the boat has altered course about 60 degrees off the original track.
  - b Put the rudder "hard over" in the opposite direction until the boat's heading has reached the reverse direction to the original course when the incident occurred.
  - c The boat should then be following back on the original track.
- 4 If the missing person is found, then bring the boat upwind of the person. Stop the boat in the water with the person alongside, well forward of the propellers.
- 5 Safely bring them aboard and administer first aid.
- 6 Notify the authorities that the missing person has been found and report their condition.

Attempt the Williamson turn only after gear is either cut or retrieved.

## Protect Yourself from Job Hazards

By following the proper procedures for a task and staying focused and alert, a workplace will be a safe environment. The fishing industry is no exception. Whether you are on a wharf, boarding a vessel, or at sea, working conditions can be safe if everyone involved in the operation is committed to safe working practices.

### Understand the hazards

A hazard is a "risk or chance associated with danger." Hazards to workers are anything that can present a danger to them, their co-workers, or the property (equipment) at the workplace. Hazards are generally divided into four categories: physical, atmospheric, biological, and ergonomic.

All four hazards may be present in the workplace within the fishing and aquaculture industries. Some hazards fall into two or more categories.

#### ■ Physical hazards— gear and equipment on board

A big problem facing the crew of a boat is the amount of gear and equipment that is necessary to bring on board. Space is limited. Nets, lines, hooks, and other gear may block doors, alleyways, and routes on deck. This creates a dangerous situation. Physical hazards account for the most injuries within the industry.

**Hazard** Fishing gear and equipment on the decks.

**Danger** Tripping, bumping into, and getting tangled in the gear and equipment. This is especially dangerous in rough seas or when launching the gear.

**Precaution** Always secure the gear and equipment when it is not in use. Coil ropes and hang them up on a wall or post. Secure buoys, tanks, and buckets using chains, rope, or straps. Never leave equipment in front of a doorway or gangway.

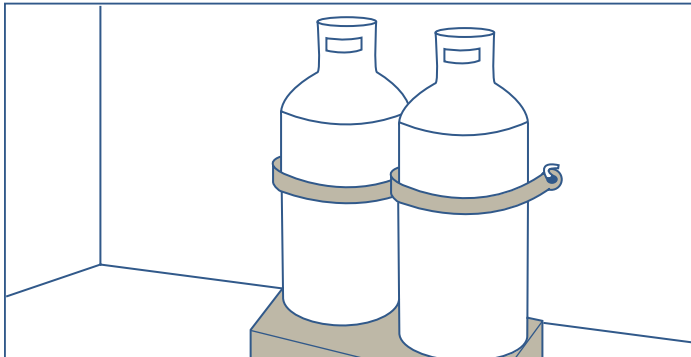

**Hazard** Pipes, beams, and posts.

**Danger** Bumping your head, eyes, arms.

**Precaution** Become familiar with the boat, learn the layout, and see where there may be a potential for an injury. Wear the proper personal protective equipment in areas where there is a chance to sustain an injury.

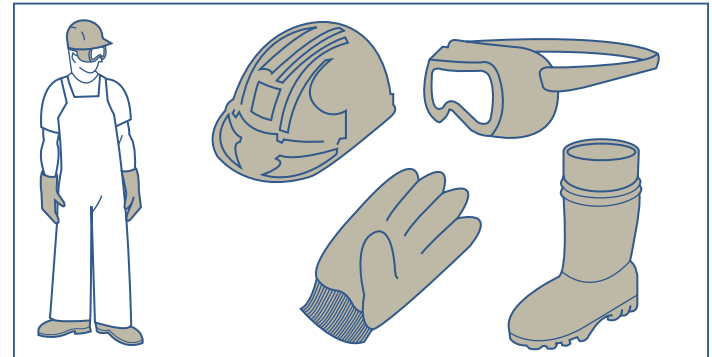



Hazard	Electricity.
Danger	Electrical shock.
Precaution	Never touch a bare wire, even if you believe that it is "dead" or not connected to a panel. Don't work on equipment powered by electricity unless the power source is disconnected and locked out—not just turned off.

Hazard	Noise.
Danger	Excessive noise, either short term or long term, can cause hearing loss, tone deafness, and tinnitus (a constant ringing in the ears).
Precaution	Wear hearing protection when working in noisy areas such as engine rooms.

Physical hazards will also be dealt with in other sections of this handbook.

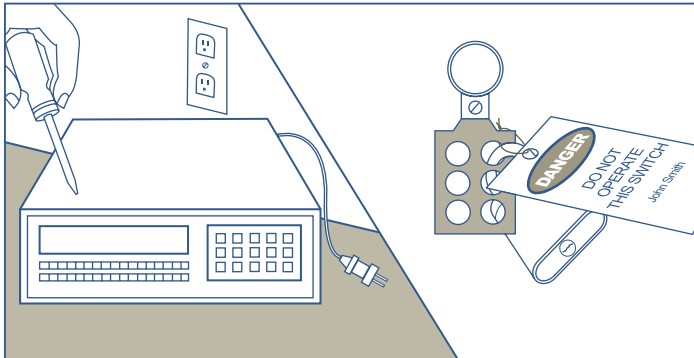

## ■ Atmospheric hazards— is the air safe in here?

The four main atmospheric hazards encountered in the fishing industry are oxygen deficiency, oxygen enrichment, explosive atmospheres, and toxic atmospheres. All four pose significant danger to workers and crew members.

Most atmospheric hazards will take place in confined spaces or other watertight compartments with little or no ventilation. Some of these areas are engine rooms, storage compartments, bilge spaces, fish holds, and wheelhouses.

Hazard	Oxygen deficiency— too little oxygen. Oxygen is used up when metals are rusting or corroding. This becomes a problem in confined spaces common on fishing boats.
Danger	Falling unconscious, death.
Warning signs	Feeling drowsy or nauseated.
Precaution	Before entering compartments, hulls, or engine rooms that have been closed for some time, allow outside air to circulate through for a few minutes.

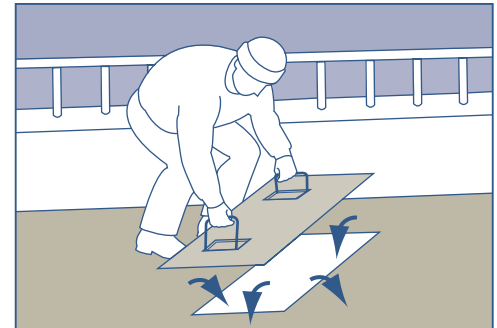

**Hazard** Oxygen enrichment—too much oxygen.  
When doing hot work, oxygen tanks and lines supplying the torch can leak oxygen into the air.

**Danger** Extreme fire hazard.

**Warning signs** None.

**Precaution** Open the door to keep air circulating while using the torch. Check for leaks regularly.

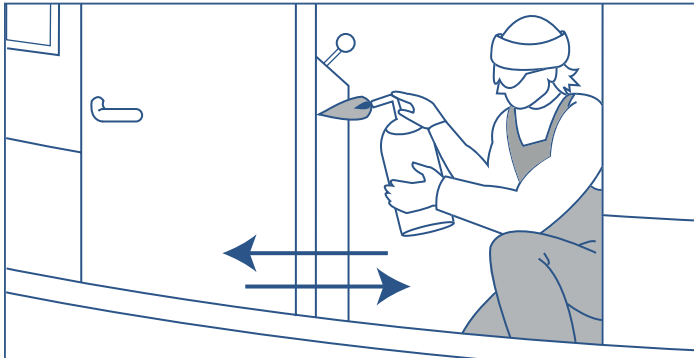

**Hazard** Explosive atmospheres—methane, propane, or gasoline fumes in the air.

**Danger** Explosion.

**Warning signs** Strong smell of fumes.

**Precaution** If you smell fumes from these gases, leave immediately, allow fresh air to circulate, then find the source of the leak before continuing.

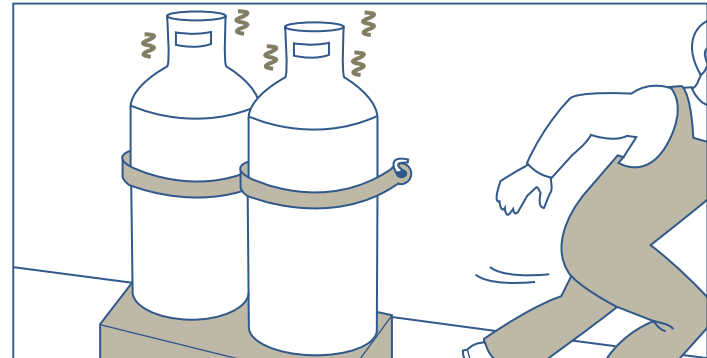

**Hazard**

Toxic atmospheres—enough of a substance in the air to be dangerous to humans.

The most common toxic atmospheres are caused by an increase or buildup of carbon monoxide, hydrogen sulfide, methane, or carbon dioxide. Other potential toxins found on boats include Freon, ammonia, and halon (used to put out fires).

**Danger**

Poisoning or not enough oxygen.

**Warning signs**

Sometimes none; might notice smell; might feel burning sensation in the lungs or unnatural feeling in the body.

**Precaution**

If you notice anything unusual, leave immediately, allow fresh air to circulate, then find the source. Do not re-enter the room until the air is deemed safe.

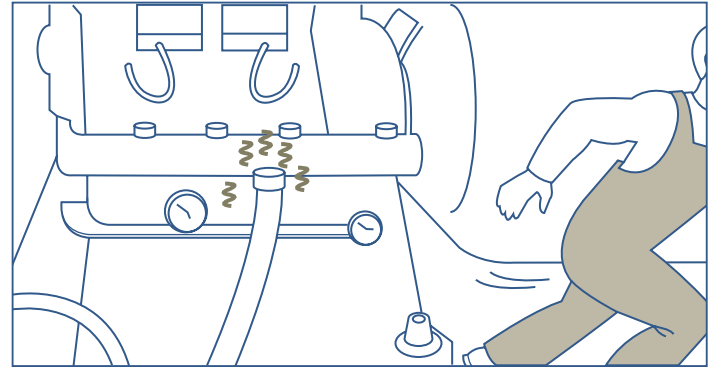

## ■ Biological hazards—sharp teeth and fish slime

Biological hazards are often overlooked in the fishing and aquaculture industries. There are two: live catch and dead catch.

**Hazard** Dead catch. Bacteria begin to rot the tissues and guts of a fish immediately after death.

**Danger** Bacteria can infect cuts or be ingested. Handling the dead catch transfers bacteria from the carcasses of the fish to the worker and to other fish. Fish particles, guts, and even whole fish can contaminate the deck, holding area, galley, or crew's quarters. Even the "slime" on both live and dead fish houses microorganisms that may be harmful to workers.

**Warning signs** Cuts become red, itchy, swollen, or pus-filled; fever; red streak appears on skin near wound; intestinal disturbances if swallowed.

### Precaution

Prevent the spread of bacteria in the following ways:

Always wash your hands and face with soap after handling the catch.

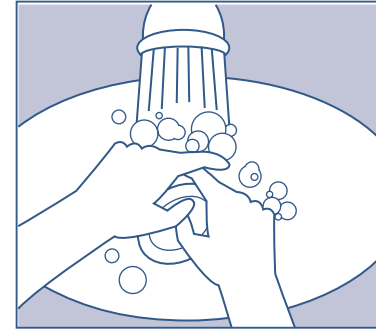

Keep meals away from the work areas if possible.



Wear gloves whenever possible.

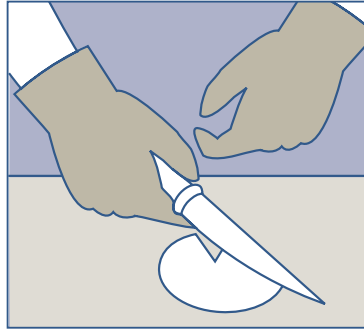

Stow all fish guts and waste as soon as possible.



Clean the fish holds and deck areas regularly.



Wash and disinfect cuts.

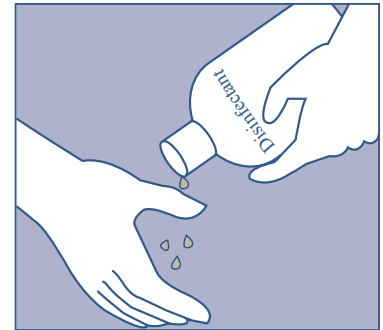

Hazard	Unloading the catch of live fish. Sharp teeth, fins, and hooks, and dangerous fish such as monkfish and sharks. Other animals such as sea turtles may also pose a danger.
Danger	Getting bitten by a fish or getting cut by a fin or hook. Could lead to an infection requiring medical attention. Getting a hand or arm crushed between a sea turtle and the deck or bulwark.
Precaution	Wear gloves to handle the catch. Always wash out a wound with water and a disinfectant. Look at the catch before handling it to identify any potentially dangerous fish or animals.

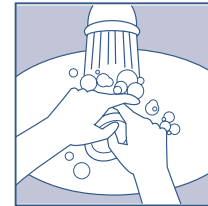
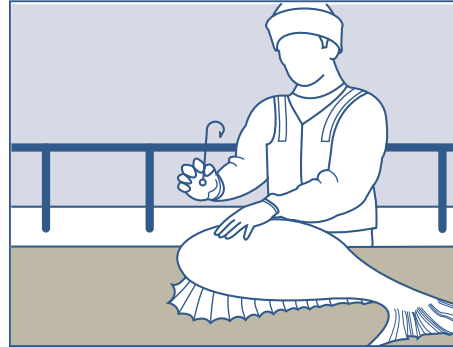

## ■ Ergonomic hazards—slipping, sliding, bending, and lifting

Small areas, slippery decks, and uncomfortable living quarters are common workplace conditions in the fishing and aquaculture industries. Lifting causes the most injury.

### Safe Lifting Tips

- Get as close to the object as possible before lifting—clear obstacles or slide the object towards you.
- Avoid twisting.
- Get help to carry very heavy or awkward objects.
- Place heavy objects on surfaces about knee high to avoid lifting to and from deck level, when possible.
- Stack or lift heavy objects no higher than shoulder level, when possible.

#### Hazard

Lifting objects.

There is constant work on a fishing vessel and lifting heavy objects is often required.

#### Danger

Sustaining a lower-back injury or dropping an object on your foot.

#### Precaution

Never put undue strain on your back. Lift with the power coming from your legs. Wear foot protection.





**Hazard** Small, compact areas on a fishing vessel such as the galley and living quarters.

**Danger** Stress and fatigue increase as comfort levels are lowered. Fatigue is one of the leading causes of work-related injuries.

**Precaution** Bring aboard necessary personal items only. Avoid being in smaller compartments if you are not required to be there. Be considerate of other crew members who are trying to rest.

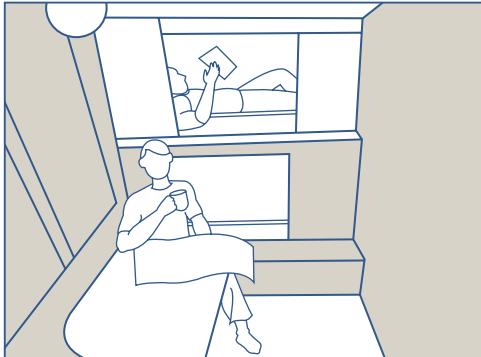

**Hazard** Slippery decks, ladders, and gangways.

Oil, grease, and fish slime are a constant presence on fishing vessels and can make conditions very dangerous.

**Danger** Slips and falls.

**Precaution** Wear boots or shoes with good grip. Clean the decks, ladders, and gangways regularly. Clean up spills right away. Keep mops and buckets easily accessible. Use non-skid protective coatings or mats to decrease the danger. Have de-icing procedures to deal with ice buildup.

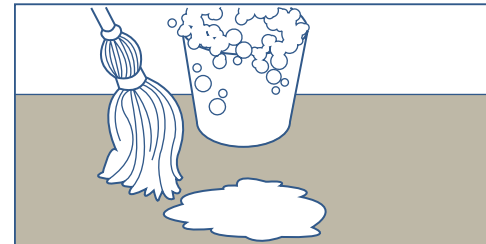

## ■ Use safety gear—personal protective equipment

Personal protective equipment (PPE) is extremely important in the fishing and aquaculture industries. It includes any clothing or equipment that helps to protect you from injury. To be effective, it must fit properly and be used according to the manufacturer's guidelines.

Also, take care not to wear jewellery or loose-fitting clothing that can get caught in nets, hooks, or machinery.

## Fall Protection

Fall protection includes both fall restraint and fall arrest.

Fall restraint is a system that prevents a person from getting to a point where they could fall. The best example of fall restraint is the guardrails and handrails that surround the boat. There should be no voids in the railings.

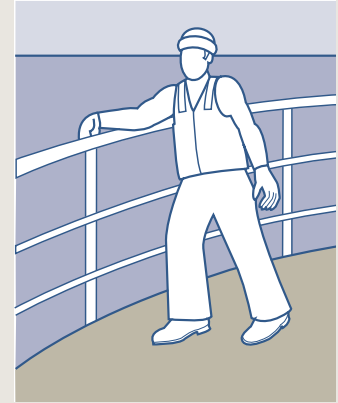

Fall arrest is a harness and lanyard system worn by a person to prevent them from falling more than a short distance.

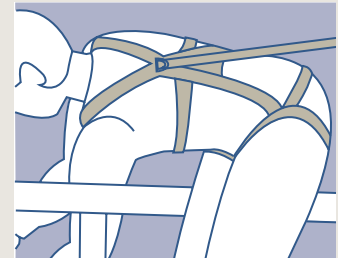

## Hard Hats



Wear hard hats in areas where you may hit your head. Hard hats should fit snugly around the head, and the chinstrap should always be done up. Newer hard hats are adjustable. Many hard hats also have clamps to secure a light or hearing protection.

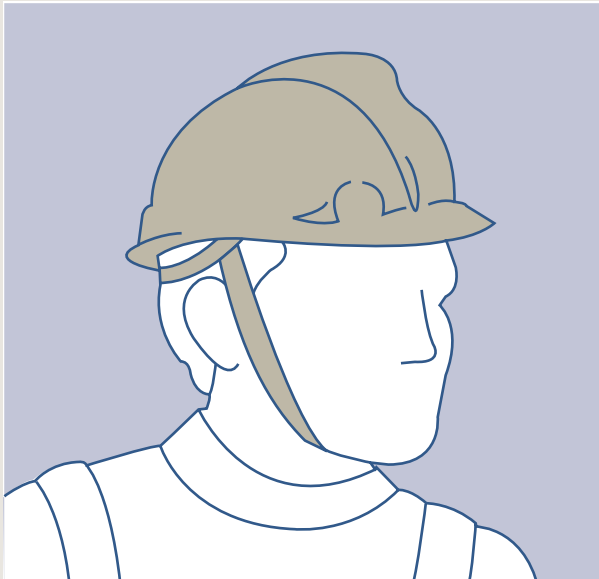

## Gloves



Wear gloves if there is a potential danger to your hands or fingers.

Rubber gloves are often the best type to wear on a fishing boat. Depending on the quality of the glove, they will provide protection against dampness, fish fins and tails, and the cold. They are also effective when handling the gear.

Cloth gloves can be worn underneath rubber gloves for comfort.

Chain mesh gloves provide excellent protection when dealing with equipment or gear that has sharp edges.

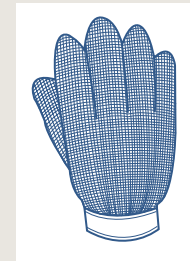
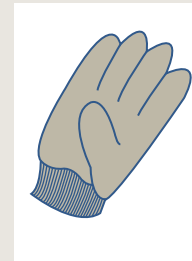

## Foot Protection



Wear boots in areas where you may hurt your foot. The feet have many small bones that can be easily broken. Safety boots are leather or rubber with a steel toe. They offer excellent protection against

- Falling objects.
- Stubbing your toes.
- Sharp objects such as hooks.

Insulated safety boots protect the feet from cold.



## Eye Protection



The eyes are sensitive, fragile, and irreplaceable. Wear protective glasses or goggles when working with hooks, winches, or hoists, and when hauling in nets with live fish. The fish will become agitated and flop around. A fin to the eye could be disastrous.

Salt water and fish slime can irritate the eyes. Goggles are especially effective because they provide an airtight seal around the eye.



## Winch Operation Signals

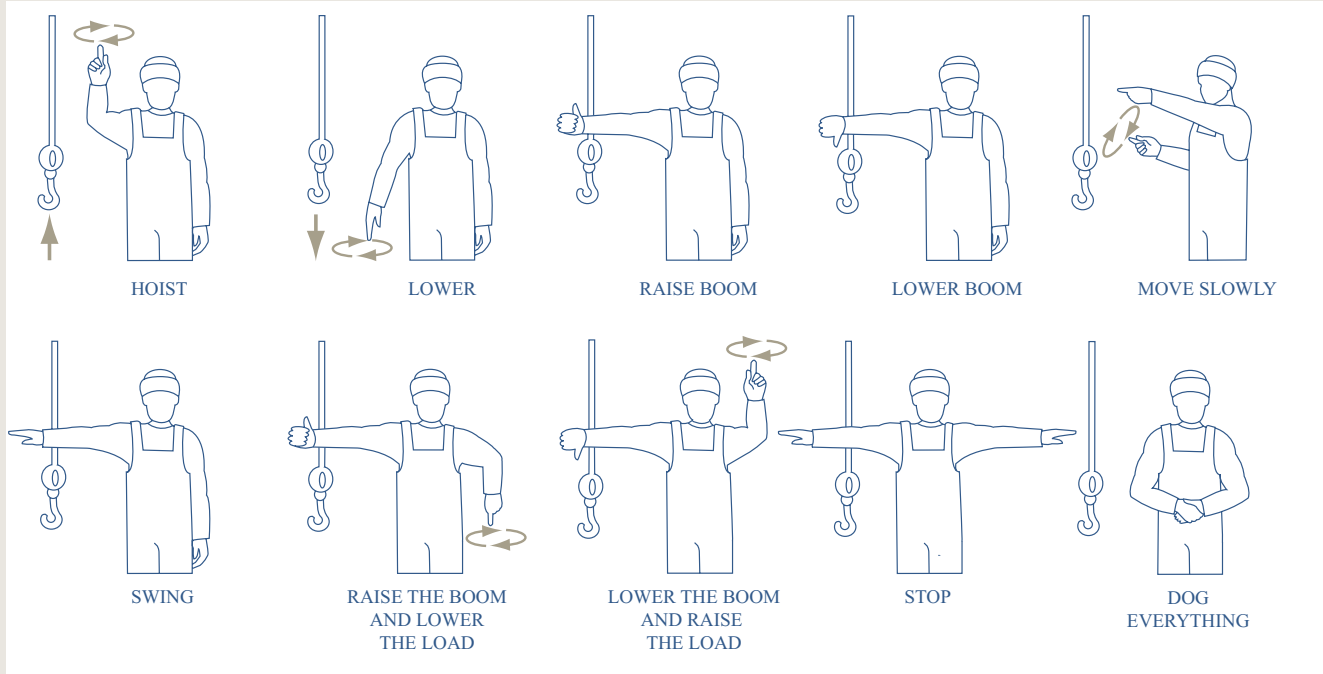

## ■ Know how to communicate

The ability to communicate is of the utmost importance. Everyone on board should know the communication systems you are working with and be trained to use them.

### Radiotelephone

The most important use of radiotelephone is to gain information that will prevent an incident or, in case of an incident, provide information to potential rescuers. Everyone should know how to properly use the radiotelephone to call for help.

### Hoisting signals (from the deck to a helicopter)

It is Search and Rescue (SAR) policy to recognize hand signals from their own crew only. They drop someone on board to handle the operation.

Know the proper signals when coordinating signals on deck.

Maintain equipment properly to avoid potential incidents. Inspect all the equipment before taking the boat out to sea or participating in aquaculture activities. Report any equipment not in working order to the supervisor. Ensure that the person using the equipment is properly trained in its use. If you do not know how to use a piece of equipment, ask for help.

You should also know the hazards associated with the equipment and use safe procedures to minimize the risks.

### ■ Electrical appliances and equipment

Many fishing vessels carry sophisticated electronic equipment such as sonar, radar, computer systems, and communication systems, usually near the wheelhouse. Galleys have freezers, ovens, and refrigerators.

Each of these items is connected to a power source. This can create a mass of wires. Dangers associated with electrical wires are tripping, electrical fires, and being electrocuted.

Precaution      Prevent wire snarls and reduce tripping hazards.

Tie (bundle) the wires together for each system.

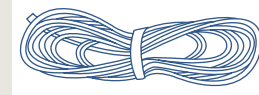

Wrap up extra wire on a spool or roll it and tie it.

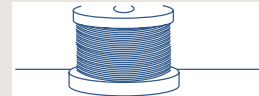

Secure the wires to beams or the ceiling to keep them from dragging or hanging.

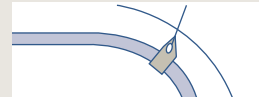

Electrical fires are common in fishing boats. They can be extremely dangerous, especially if they occur in a galley or wheelhouse that is between the crews' accommodations and the deck.

Precaution To prevent **electrical fires**.

Never overload an outlet with too many plugs.

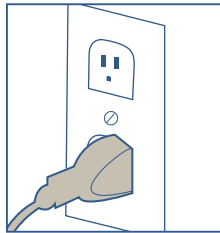

Precaution To prevent being electrocuted.

Put a Marrette on the end of wire connections.

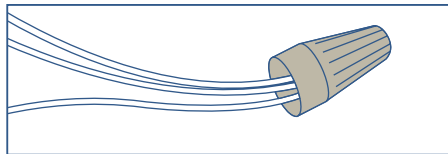

## ■ Engine room/compartment safety

Engine rooms and compartments can be dangerous in many ways

Pipes and valves can cause head or eye injuries. Wear hard hats and eye protection.



Fuel tanks can leak, creating an explosive atmosphere. Allow fresh air to circulate regularly.

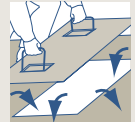

The water and fish matter tracked in from the deck can make floors slippery. Keep floors clean and dry.



The noise generated in engine rooms can create hearing problems—both long term and short term. Wear hearing protection.





## ■ Mechanical equipment

Use mechanical equipment only if you are trained in its proper use. Many pieces of mechanical equipment on fishing boats or at aquaculture sites can't be stopped quickly enough to prevent serious injury.

**Precaution** To avoid injury stay clear of the equipment when in use.

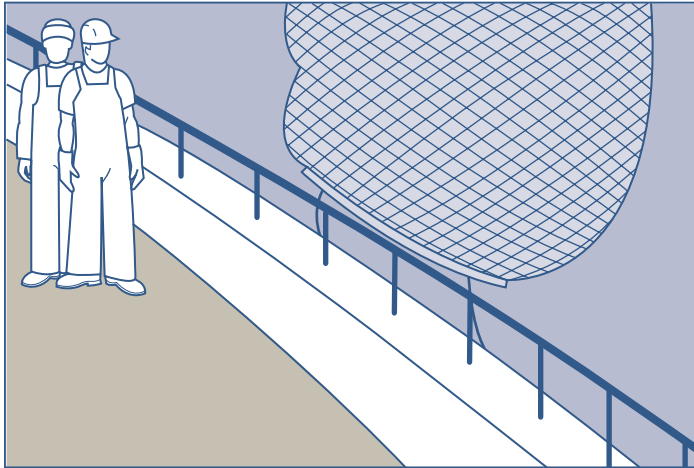

**Precaution** Unless you are the operator, stay clear when a winch or hoist is being used.

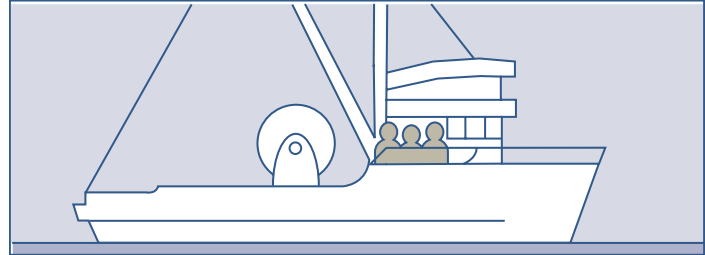

**Precaution** Make sure that no one is working around the radar scanner before you operate it. Rotating arms can knock crew members over, and an operating scanner gives off radiation.

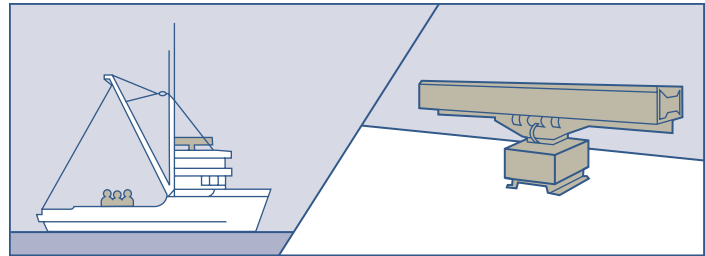

## ■ Gear

The gear on fishing decks includes such things as nets, head-ropes, bridles, and drags.

Getting caught in the gear is one of the leading causes of falling overboard. It is also one of the most dangerous situations. Even if you can swim, you may be unable to get to the surface if you are tangled in the gear. Other injuries common when getting caught in the gear are dislocated fingers and shoulders, concussions, rope burns, amputations, and fractures.

### Precautions to take when handling gear

Keep your feet away from the gear as it is being set.

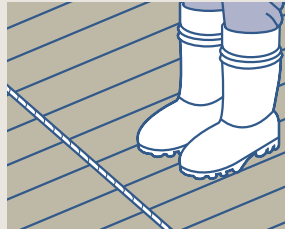

Have a sharp knife readily available to cut snags.

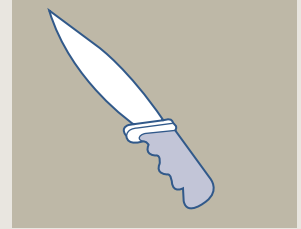

Never hold more of the gear than is necessary.



Wear boots or shoes with good grip to avoid slipping into the gear.



## ■ Ropes

Ropes are an essential part of both the function and safety of fishing vessels. They are used to

- Tie the boat to a dock.
- Form part of a fall arrest or rescue system.
- Tow nets and gear.
- Secure equipment so it doesn't shift.

### Precautions to take when handling ropes

Wear gloves. All types of ropes can cause rope burn.

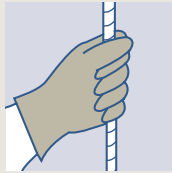

Keep hands and feet away from ropes that are in use unless you must handle the ropes to perform a specific task. If a hand or foot gets caught in a bight in the rope, you may get hurt or hauled overboard.

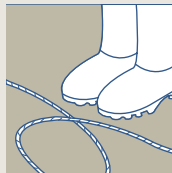

Don't stand on ropes that are under tension.

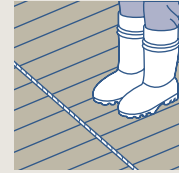

If a rope becomes snagged and needs to be cut, stand behind the snag and cut away from yourself. This reduces the chance of being hit by a recoiling rope.

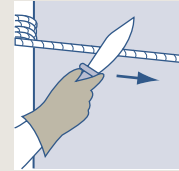

Properly maintain and inspect ropes. If a rope is frayed or some of the braids are severed, replace it. A flawed rope will usually break while performing a function, such as hauling in a net.



## ■ Hoists, cranes, and derricks

Hoists lift heavy things such as skiffs, lifeboats, seines, trawler doors, and drags. They are also called cranes and derricks. They are dangerous to be around, because

- Heavy loads are suspended over people's heads.
- Chains, blocks, and other gear are suspended over people's heads.
- Heavy objects are in motion—the boom usually moves horizontally while the load moves both vertically and horizontally.

### Precautions to take when working around hoists

Stay clear while a hoist is in operation unless you are part of the procedure.

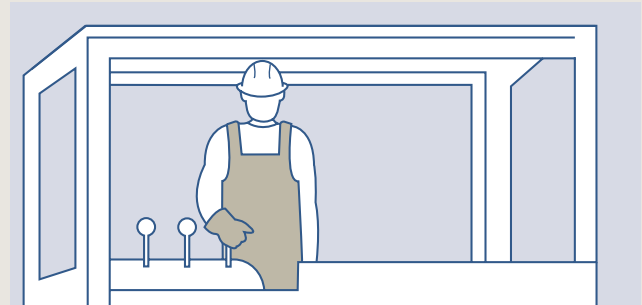

Wear a hard hat and foot protection.

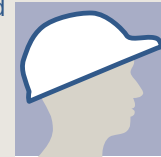

Steady a load being lifted only.  
Never try to help lift the load.

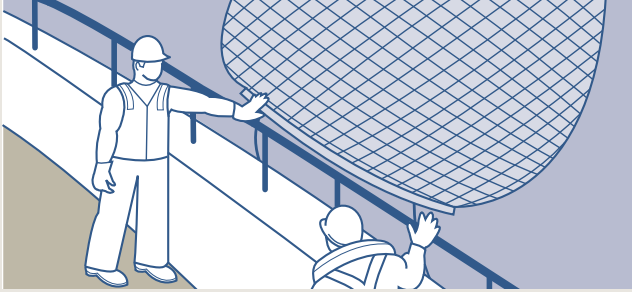

Check the hoisting system regularly for problems with welding, rivets, chains, pulleys, ropes, blocks, hooks, and so forth.



Secure power blocks with a safety chain.

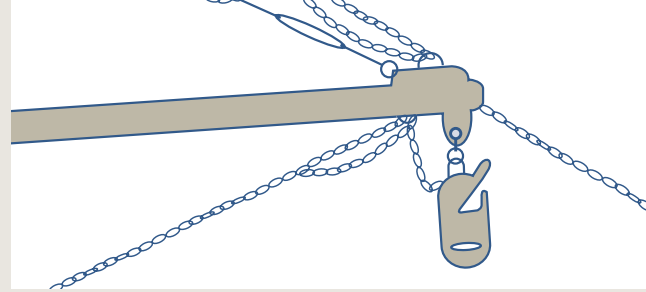

Operate a hoisting system only if you are trained to do so.

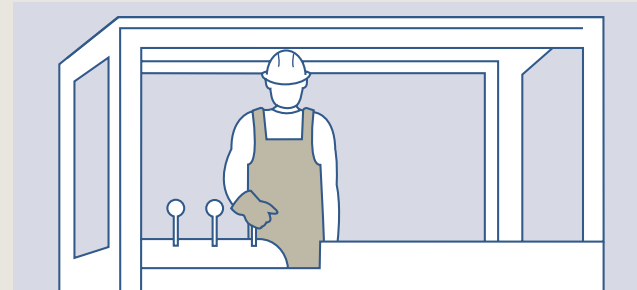

### ■ Winches

Dangers associated with a winch include

- Getting a hand or foot stuck in the winch drum as it hauls back the gear or skiff.
- Getting hit by a broken line as it recoils.
- Tripping over a line.

### Precautions to take when a winch is being used

Use a tool, not your hand, to keep the winch line spooling properly in the drum.

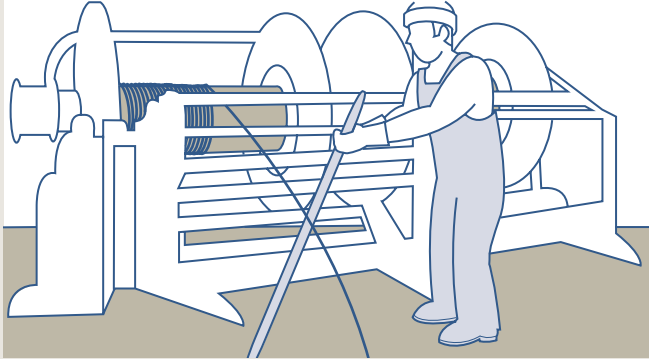

Encase the winch drum in a cage.

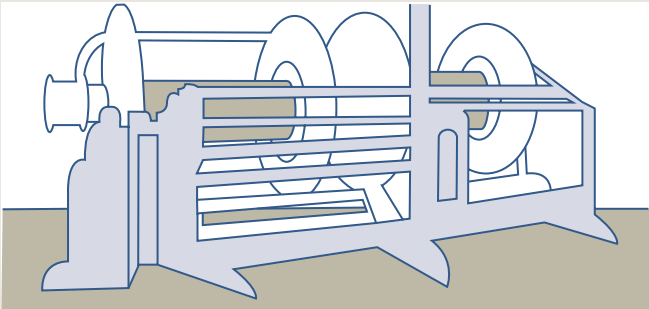

Stay off the deck unless you are part of the procedure.

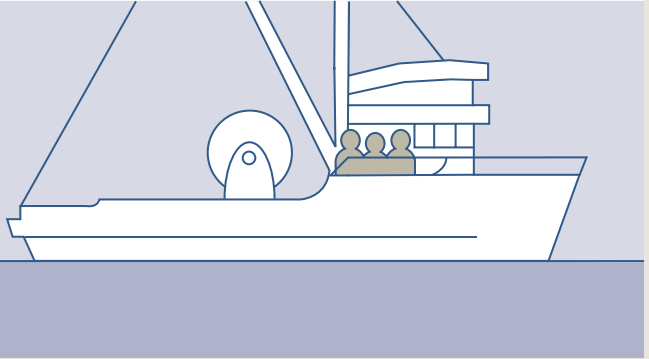

Never stand on a winch line, especially when it is under tension.

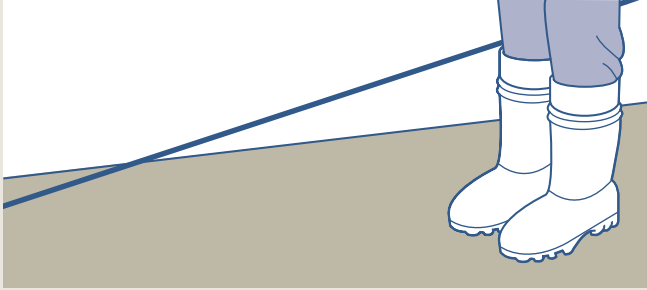

Never try to walk over a winch drum, go around it.

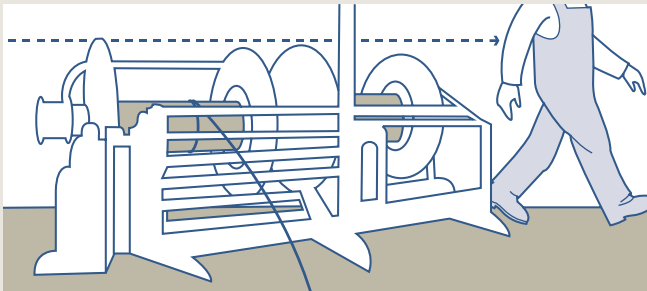

Inspect the winch system regularly for frayed or broken fibres in the line.

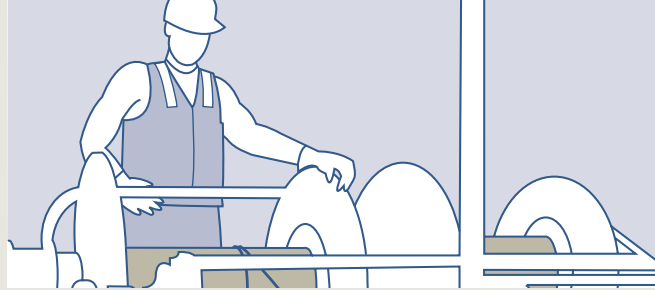

Keep the winch operator informed about what is happening on the deck.

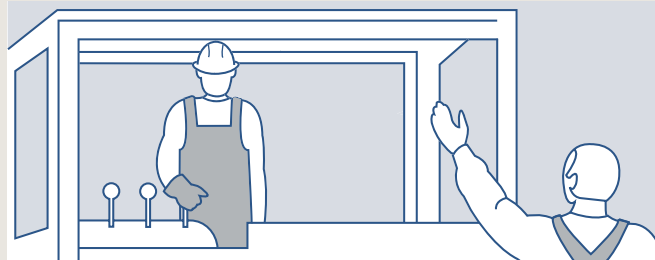

Maintain both hoists and winches according to the manufacturers' instructions.

## ■ Off-loading safety

### Harvesting equipment

Fish harvesting and aquaculture take place on the water. They use machinery such as hydraulic winches and star wheels, as well as brail nets, winches, and knives. Although most processing (preparing the finished product) takes place on land, many operations use processing machinery, such as mussel socking machines, on the water. The more sophisticated operations also use conveyor belts, agitators, and other mechanical devices for harvesting.

### Equipment safety

- Never operate equipment or mechanical systems unless you have been properly trained.
- Shut down and lock out the power source before servicing or repairing mechanical systems.
- Repair equipment and mechanical systems according to the manufacturer's guidelines.

### Common processing injuries

**Danger** Broken or amputated fingers.

**Precaution** Wear gloves when working around conveyor belts or other mechanical equipment.



**Danger** Cuts in and around the eye.

**Precaution** Wear a hard hat and safety goggles when there is danger of sustaining a head injury.





### Other equipment

Some operations will also use forklifts, skid steer loaders, or other utility vehicles to load or unload a barge or vessel. The driver must be trained in the operation of the vehicle, and the vehicle must meet the requirements set forth for registration and inspection.

**Danger** Falling off equipment.

**Precaution** Never stand on the bucket, forks, or other accessories of the vehicle, especially while it's moving.

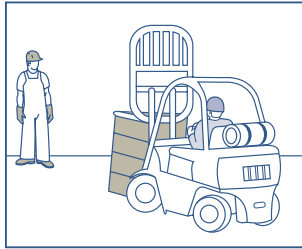

**Danger** Getting pinned under a load.

**Precaution** Never unload a pallet unless the pallet is released from the forks. The pallet could fall or shift if the forklift is started.

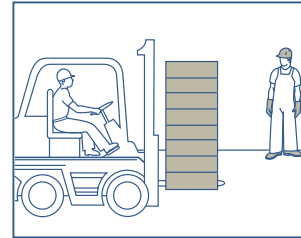

**Danger** Getting hit by falling equipment or load.

**Precaution** Ensure that the bucket is close to the container before emptying it. The bucket or the load could fall on you.



## Keep Alert to Weather Hazards

Weather in the North Atlantic Ocean can be dangerous and unpredictable. The captain of the boat must understand clearly both the forecast and the conditions associated with various types of weather. The two major weather problems are wind and cold.

Wind causes waves that may cause the boat to heel.

Freezing spray can cause ice to build up on the boat and equipment. Ice buildup adds extra weight that the boat may not be designed to handle, reducing the boat's stability. This may cause the boat to founder, capsize, or sink.

### ■ Listen to marine forecasts

Weather can vary greatly between the mainland and the open seas. Even coves, inlets, and harbours can have weather considerably different than the land or open ocean around them. Therefore, the regular forecasts given by Environment Canada or other weather agencies geared toward the general public are not always useful to the crews of fishing vessels.

The fishing industry relies on the information given out in marine forecasts. Environment Canada issues a marine forecast for different areas around Nova Scotia several times a day. These updates are carried on various radio stations across the province and on Marine VHF or can be obtained by contacting Environment Canada.

## Wind Warnings

Some of the important meteorological wind warnings include

Gale warning  
Beaufort Force 8 or 9  
34 to 47 knots  
63 to 88 km/h

Storm warning  
Beaufort Force 10 or 11  
48 to 64 knots  
89 to 117 km/h

Hurricane warning  
Beaufort Force 12  
Greater than 64 knots  
Greater than 118 km/h

Environment Canada also issues freezing spray warnings.

## Weather Map



## ■ Watch for signs of bad weather

Even without an up-to-date weather forecast, an experienced captain or mate will see bad weather approaching. Watch for these signs:

- Choppier seas.
- Cloud bank in the distance.
- Rise in humidity.
- Rapid change in atmospheric pressure.

### Precautions to take if bad weather is a possibility

Batten down the hatches to keep water out.

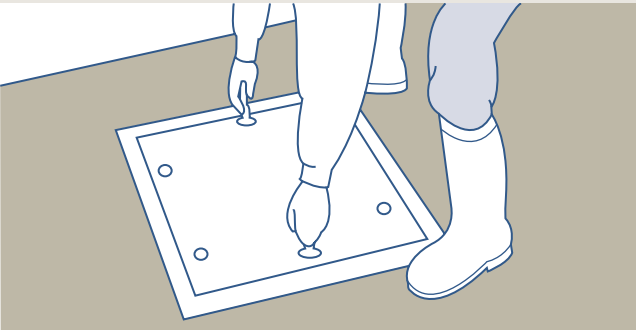

Secure the equipment in its proper place. Shifting cargo and equipment can cause listing.

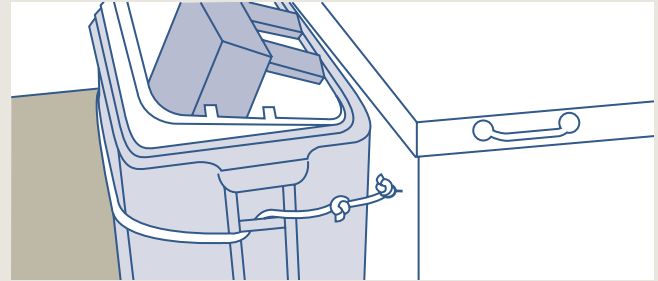

Get out of the storm area as quickly as possible.

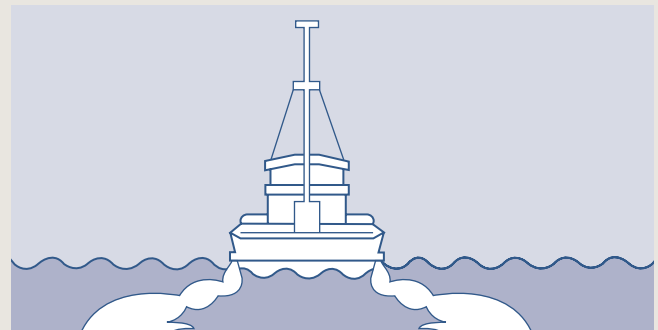

## Protect Your Boat from Fire

Unfortunately, fires are common on fishing boats. There are only two ways to deal with a fire on a vessel: try to contain the fire until help arrives or the crew can extinguish it, or abandon ship. It's far better to prevent the fire from starting in the first place.

### ■ Inspect electrical systems regularly

It is important to have electrical systems installed by a qualified marine electrician. It is also important to have the boat's electrical systems inspected regularly, as often as the manufacturer suggests.

### Wires

The wires on fishing boats are constantly exposed to salt water. This makes the coating on wires more susceptible to corrosion and rot. Do a visual inspection of the wires periodically. Flickering lights and sudden disruption in power can be a sign that something is wrong with the wiring.

### Equipment

Visually inspect connections, switches, and wiring regularly. If you notice any problems with the equipment, get it fixed by the manufacturer or a person qualified to repair it.

## ■ Store flammable and combustible materials safely

Store flammable and combustible materials such as propane, gasoline, Varsol, or other solvents away from both sources of heat and oxygen tanks. Secure the lids tightly on the bins or containers. Keep on board only those flammable or combustible materials that are necessary for the maintenance, operation, or other function of the boat.

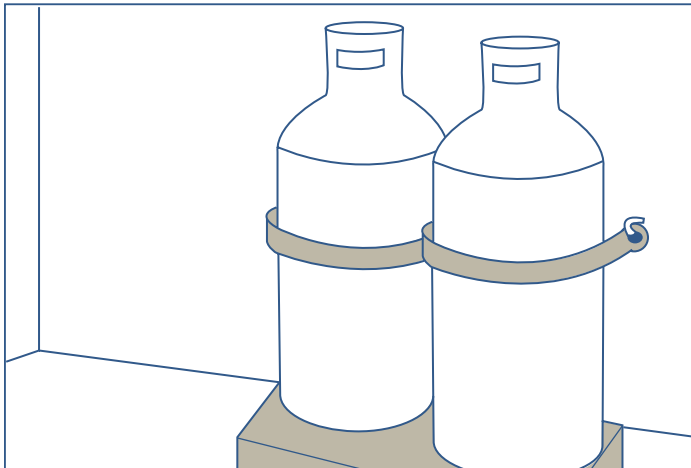

## ■ Keep an ABC fire extinguisher on board

The three most common types of fire occurring on fishing vessels can be classed as type A, B, and C. Accordingly, the three most common extinguishers are rated for class A, B, and C fires.

### Fire Extinguisher Ratings



Class A  
Used on ordinary  
fires that leave ash  
(wood, plastics,  
cardboard, etc.)



Class B  
Used on  
flammable liquid  
fires



Class C  
Used on  
electrical fires  
(wires,  
appliances, etc.)

Keep an ABC fire extinguisher on board. These extinguishers are filled with a dry chemical that can settle at the bottom. Turn fire extinguishers upside down occasionally and tap the bottom to prevent settling of the chemical, as often as the manufacturer suggests.

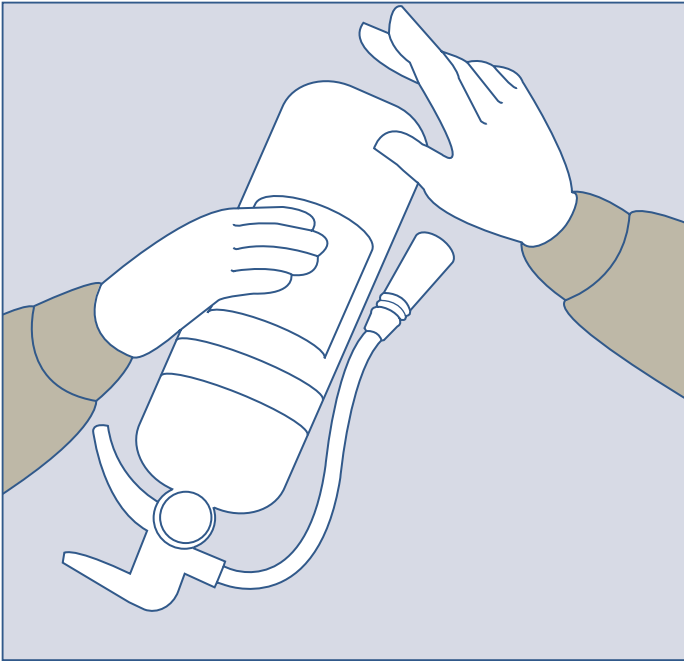

## Know First Aid and CPR

It is extremely important to have crew members that are knowledgeable in first aid. Many injuries occur either when the vessel is on the water or when the vessel is docked in a small village, away from hospitals or professional medical personnel. The ability of someone to administer proper emergency first aid can mean the difference between life and death.

In addition to first aid, there should be crew members that are qualified to administer cardiopulmonary resuscitation (CPR). Crew members that have gone overboard, especially in frigid water, may be unconscious and, in extreme cases, have no pulse. The only way to keep these people alive until they can get to a hospital is by administering CPR.

### ■ Get training

The ability to save a life by performing emergency first aid can be learned through the training courses offered by certified instructors throughout the province. These programs are usually only one or two days long. The marine advanced course is two and one-half days. They teach you how to properly treat injuries such as fractures, sprains, cuts, and burns—all common in the fishing industry.

Many courses include CPR training. This valuable skill can be learned in just a few hours.

First aid courses teach you how to properly

- Tie a sling.
- Set or stabilize a fractured or broken bone.
- Bandage a cut, scrape, or burn.
- Stop severe bleeding.
- Move injured crew members.



## ■ Keep first aid kits well stocked and readily available

Have first aid kits available at the workplace. The size, number, and sophistication of the kits will depend on the workplace. Large boats may require more than one kit. Each kit must include the following items:

- bandages
- gauze
- adhesive tape
- scissors
- latex gloves
- antiseptics (hydrogen peroxide, alcohol)
- splints
- dressings

Keep the first aid kits in an accessible area, clearly marked as first aid kits. Make certain that the contents have not passed their expiry dates.

Make sure that workers know where the first aid kits are located on the boat.

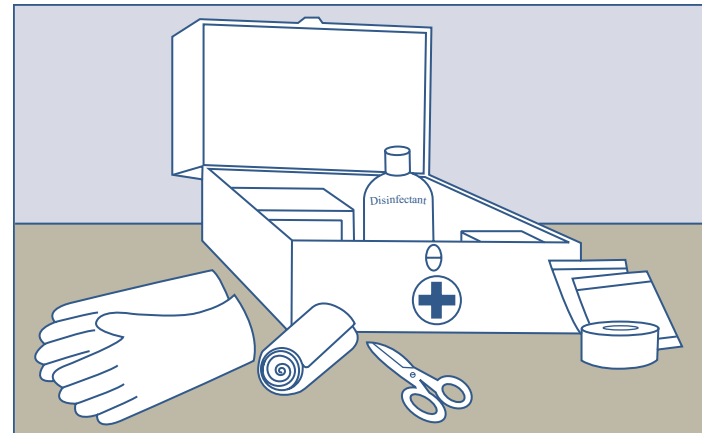

## Section 2: Fishing Safety



## Trap Fishing

Trap boats are relatively small compared to other vessels. Space on deck is limited, especially before traps are set and after the traps are hauled in. This makes even routine tasks dangerous. However, trap fishing can be safe if certain precautions are taken.

### ■ Loading the boat

A boat is most stable when it has a low centre of gravity. Keep your boat's centre of gravity as low as possible by keeping your load low and spread evenly about the deck.

**Danger** If you load the traps too high, your boat may capsize. If you stack too many traps on one side, your boat may list.

**Precaution** Don't stack the traps too high. Ensure that the captain or skipper can see well through all the windows aboard the vessel when traps are loaded.

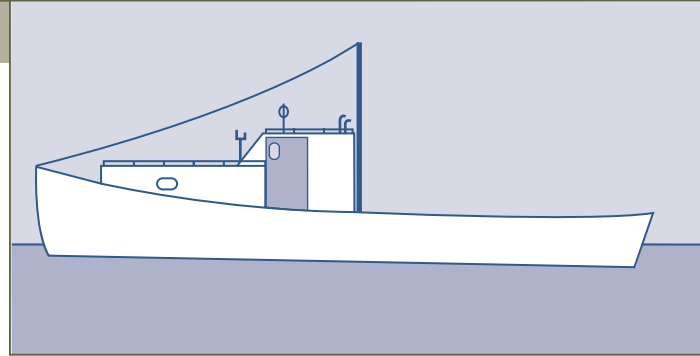

**Precaution** Stack the traps evenly around the deck.

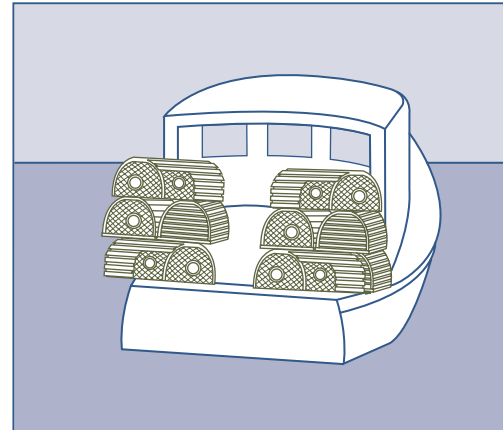

Precaution Don't exceed the capacity of the boat.

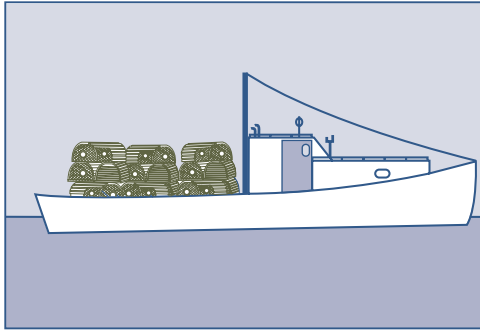

Precaution Don't clutter the deck with unnecessary traps or gear.

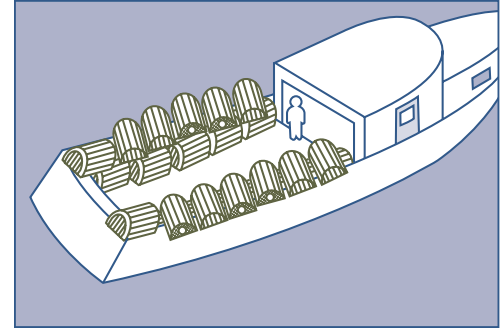

Precaution Use wire or collapsible traps to reduce the weight. They are also easier to stack.

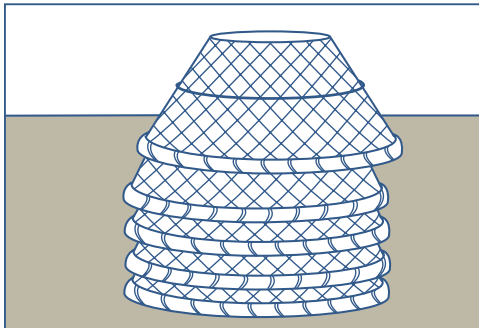

Precaution Secure the load so it does not shift on rough seas.

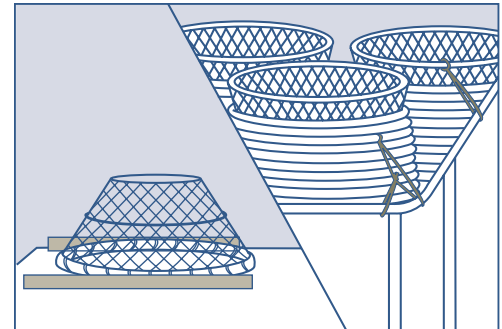

## ■ Baiting the traps

Take care when baiting the traps. Some traps have large, sharp spikes that hold the bait or bait bag. Bait is usually pieces of dead fish, which may contain harmful bacteria.

**Danger** Sharp spikes on traps plus bacteria on bait.

**Precaution** If you pierce your skin on the spike or a fish bone, clean it with an antiseptic as soon as possible.

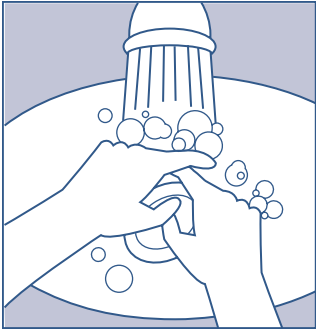

## ■ Setting the traps

The most dangerous part of trap fishing is setting the gear. As the boat moves forward, the traps are set out either through a gate in the stern or over the side.

**Danger** If your foot or hand gets caught in the gear, you can be hauled overboard.

**Precaution** Crew members not involved in setting the traps should stay clear of the operation.

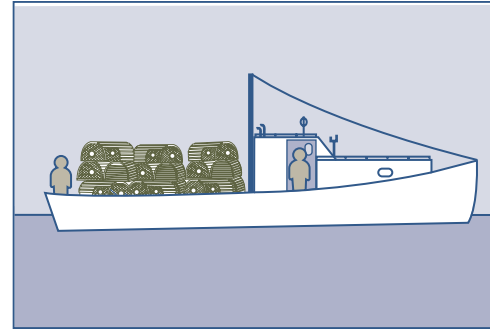

Precaution Wear boots with good treads.



Precaution Keep an eye on your work and don't be distracted.



Safe procedures

If a crew member does fall overboard, take the boat out of gear and ensure that the person overboard is not in danger of being injured by the propeller action. Then begin rescue efforts.

## ■ Hauling back the traps

**Danger** Getting a finger or hand caught or jammed in the hauler. A finger can be lost or a hand mangled before the hauler can be stopped.

**Precaution** Stand clear of the hauler unless it is your job to make sure it is functioning properly.

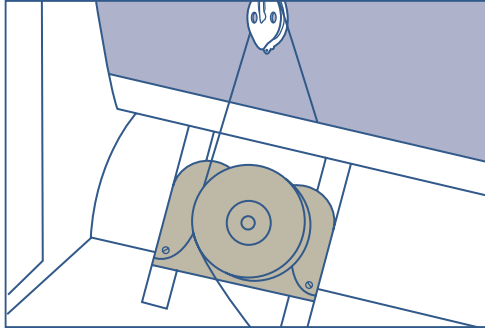

**Precaution** Have the emergency shut-off within easy reach of the hauler operator.

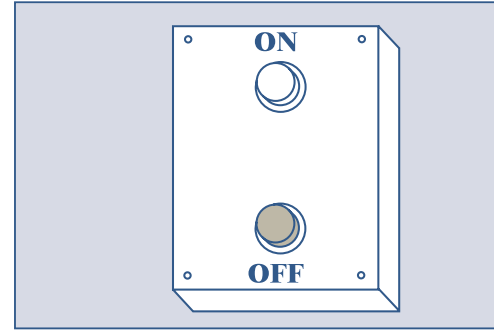

**Precaution** Keep your hands clear of the running line—never grab the line.

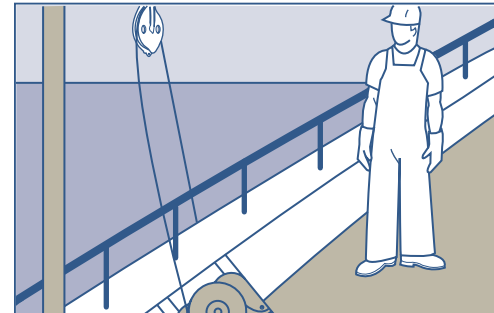

## ■ Gaffing a buoy

Danger Falling overboard.

Injuries from pointed ends of gaffs.

Precaution Always wear a PFD and a fall arrest system. Even a rope tied to a secure post or rail will keep the gaffer from falling overboard.



Precaution Don't overreach to gaff a buoy.

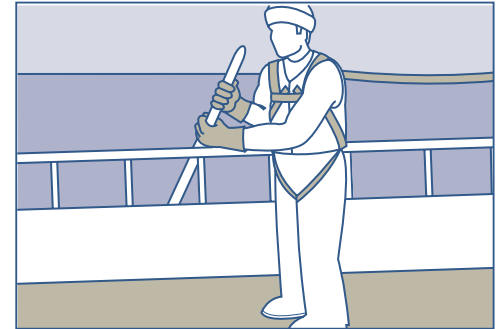



## ■ Banding the lobster

**Danger** A lobster's crusher claw can give a nasty pinch.

**Precaution** Always keep an eye on the lobster that you're banding. Keep your work area well organized and free of unnecessary items. Have the banding tool, bands, and other necessary supplies for banding close to hand.

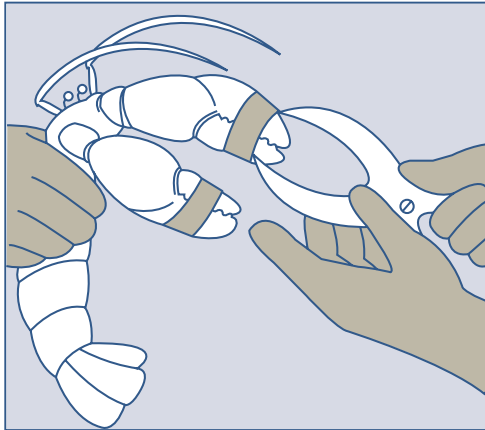

## ■ Other safety precautions

Check gate latches and bolts. Make sure the hardware (latches, bolts) that keeps the stern gate closed is in good working order.

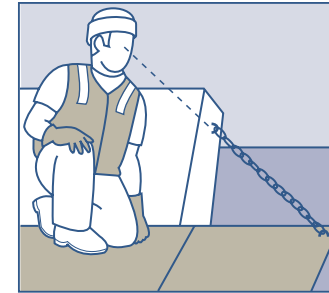

Check that hatches are airtight. Make sure the hatches are airtight. Trap boats will take on water in rough seas. That water should not get into the compartments below deck.

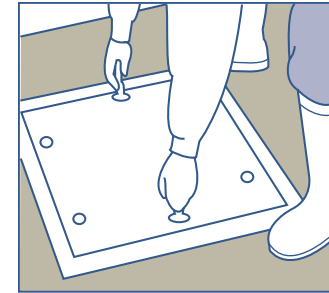

Keep the boat operator informed.

Make sure the operator of the boat knows what is happening on the deck at all times while setting or hauling the traps.



Clear the scuppers.

Make sure scuppers along the rail have are large enough to allow water to drain from the deck should the boat take a sea on board.

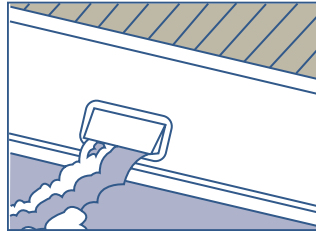

## Scallop Dragging

The greatest danger when scallop dragging occurs while the gear is being set or hauled back. The gear used in dragging is heavy and somewhat awkward to work with. As well, the gear is set and hauled repeatedly throughout the fishing voyage, thus increasing the chances of a workplace injury.

### ■ Setting the gear

**Danger** Getting a hand caught in the steel rings of the net and chains of the drag bar.

Getting hit by the drag, rings, or dumping pole.

Having a hand or foot crushed between the bulwark and the gear.

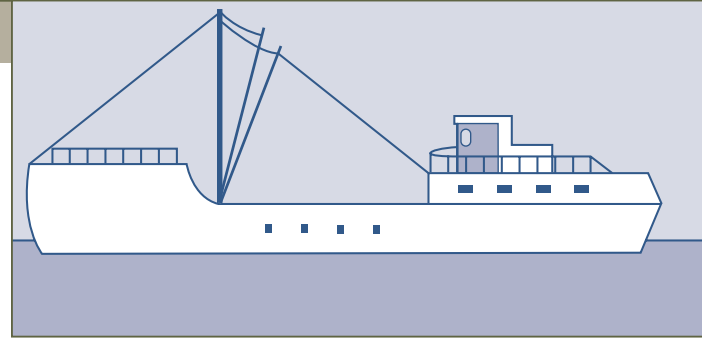

**Precaution** Wear gloves.



**Precaution** Do not wear loose-fitting clothing or jewellery.

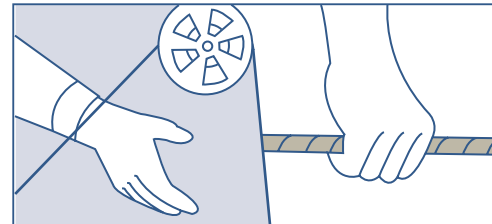

**Precaution** Do not place yourself between the drag and a large, stationary object or post.

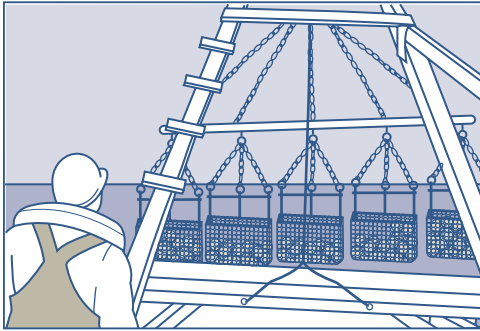

## ■ Hauling back the gear

**Danger** Getting hit by a falling block, a moving hoist, or the gear itself.

Getting a finger, hand, or foot crushed by the drag or dumping pole as it is hauled onto the deck.

Getting caught in the winch drum as it hauls the drag.

Getting hit by a snapped winch cable.

**Precaution** Wear a hard hat.

**Precaution** Stay clear while the gear is being hauled back.

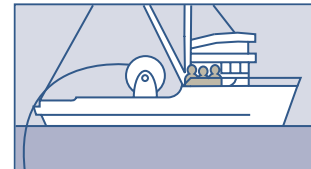

Precaution Stay away from the winch drum as it hauls the drag.

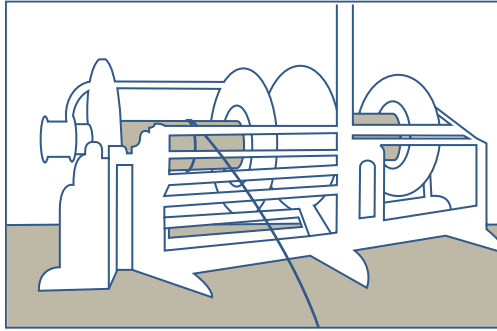

Precaution Do not stand under the drag as it is hauled back on deck or unloaded.

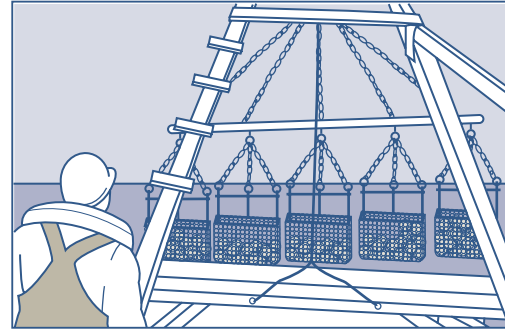

Precaution Don't attempt to climb over the winch drum.

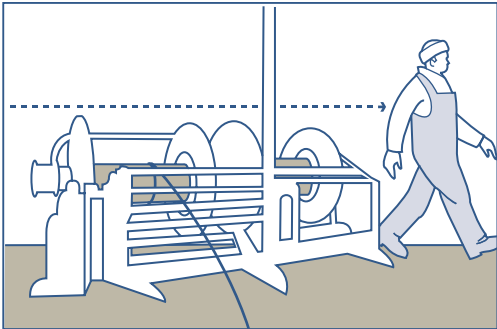

Precaution Do not stand on any lines, wires, or cables that are under tension.

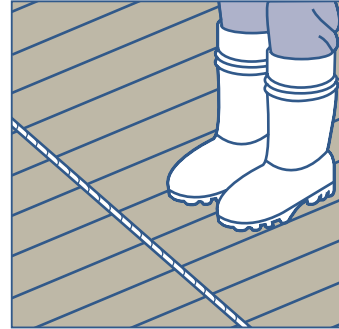

## ■ Sorting the catch

**Danger** The drag will not only collect scallops. There are often sharp objects such as rocks, metal objects, or glass that can give a nasty cut. The drag may also collect hazardous substances such as chemical (paint, solvent) containers or decomposing fish and marine animals.

**Precautions** Wear gloves when sorting the catch. Only natural materials should be thrown back in the water. Properly dispose of other materials that could cause an injury to a worker in the future.



## ■ Shucking the scallops

Although shucking can be done just about anywhere, it is best to keep this activity away from where the gear is launched or hauled back. The shucking area should be enclosed or otherwise protected from the winch cable or winch drum.

**Danger** Cuts from sharp shells; reaching injuries; slipping and tripping.

**Precautions** When shucking is done on deck, keep away from gear and winch cables to avoid tripping. Have the scallop meat buckets within reach to reduce repetitive stress injuries. Be careful handling the sharp shells.

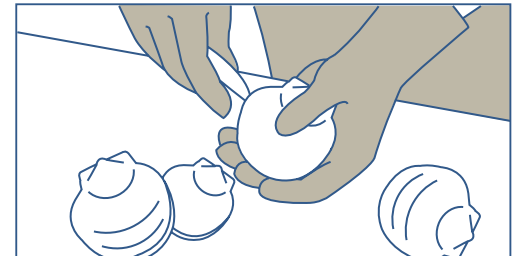

## Trawling

The danger particular to trawling is dealing with the trawl doors. A common danger is getting hands caught between the doors and the boat. Occasionally, trawl doors will twist around each other when the vessel shoots away the trawl or when caught down. Untangling heavy trawl doors over the side of the vessel or on deck is likely the most dangerous job on board a fish dragger.

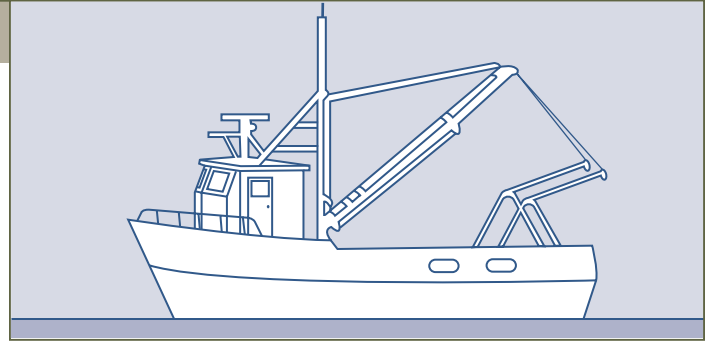

### ■ Setting and hauling the gear

- Danger**
- Getting caught in the gear as it is being set.
  - Getting caught between the trawl doors and the boat.
  - Falling overboard while reaching for a net or to untangle trawl doors.
  - Having a block, hoist, or fish fall on a crew member.

- Precaution**
- When the gear is being set, the crew should be away from it, preferably off the deck altogether. Never grab a net or line unless it is absolutely necessary.

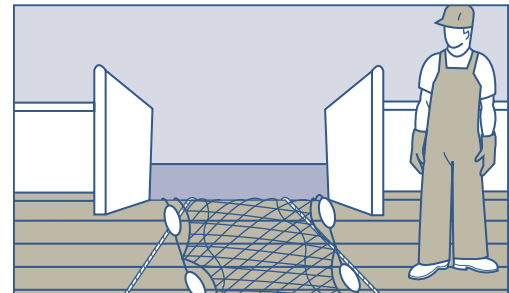

**Precaution** Keep your hands above the railing of the boat when handling the trawl doors. The doors are heavy and will crush any finger or hand that gets between them and the side of the vessel. Even when trawl doors are on board in their stored position, they must be secured tightly to the A-frame, because any looseness between the door and the A-frame causes a hazard on a rolling or pitching boat when crew members are trying to hold on.

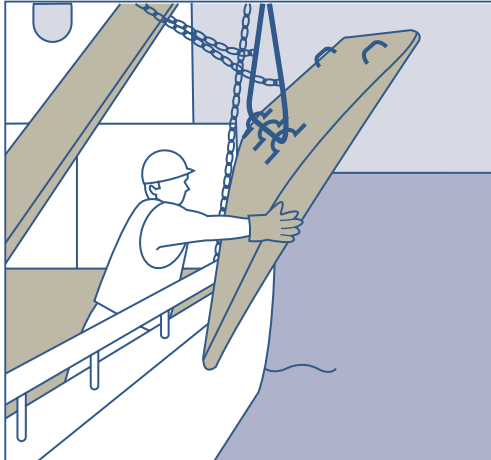

**Precaution** Don't reach too far to untangle the doors. Use a pole or other tool to try to untangle the doors.



**Precaution** Never extend too far to grab a net. Don't use both hands to grab the net if you are reaching over the side or stern of the boat—always have one hand holding a railing or other piece of the boat.

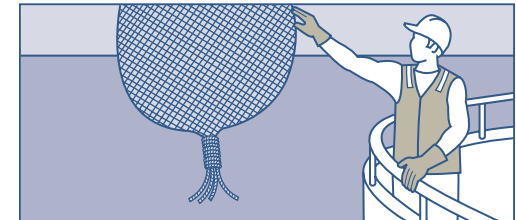



**Precaution** Wear a hard hat and protective clothing, especially when emptying the catch on the deck. Some fish have sharp fins that could easily cut a person's head.

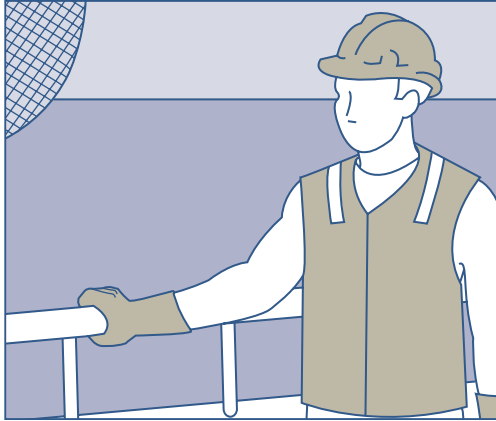

## ■ Trawling for fish

**Danger** Falling overboard at the stern while towing the net.

When the trawl is caught fast to the bottom, everything becomes more dangerous. The strong tide becomes a factor for the safety of the vessel itself. The winches are usually bogged down, causing extreme stresses on cables, pulleys, and hydraulics.

**Precaution** Gate the stern or rope it off.

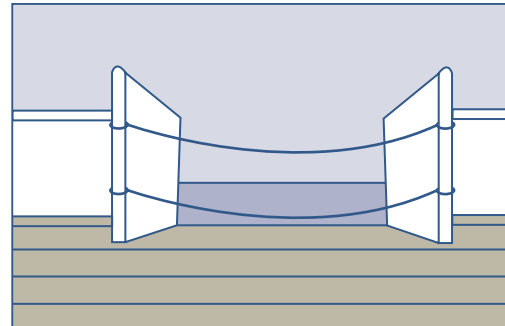

**Precaution** Make sure the winch cables and heaving ropes are in good working order. Cables and ropes that snap under tension will recoil, potentially injuring crew members.



**Precaution** Repair or replace any equipment or gear that is worn, broken, or otherwise unable to serve its purpose properly.



## ■ Sorting and preparing the catch

**Danger** Falling into fish holds.

Getting cut while dressing or gutting slippery fish on a rolling and pitching vessel.

**Precaution** Don't remove a fish-hold hatch until the fish are ready to be put in the holds. When the fish are put in, secure the hatch immediately.

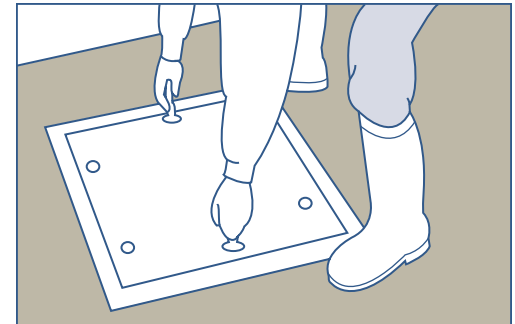

**Precaution** Keep the area as clean and tidy as possible. Take care with knives. Don't stick an unused knife on the gutting table where one can fall on it.

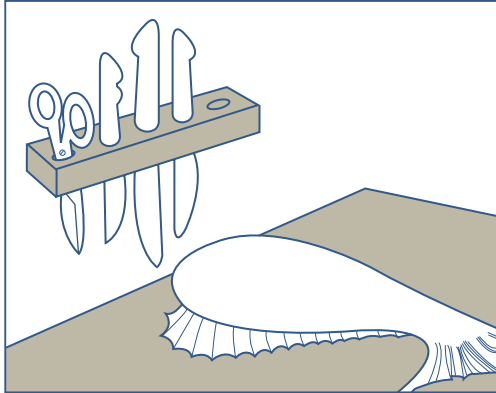

## ■ Other safety precautions

Get rest when you can. Eat properly and drink plenty of water.

Many fish draggers have a crew of 3 or 4 people working around the clock for 3–4 days. Often crew will get only a few hours sleep per day. This causes fatigue, and fatigue causes accidents.

Equip your boat with net reels.

On net reels, the controls are often found on the reel itself. The net reel can be handled by one crew member who can see the whole procedure. That person can ensure that everybody is clear before reeling the net on or off the drum, reducing the potential for injury.

Secure manhole covers and hatches.

Unsecured manhole covers and hatches can pop open in rough seas, filling the fish hold with water.

## Seining

The highly mechanical nature of seine fishing also makes it one of the more dangerous. Seiners tend to have large crews, and much of the work is done at night with minimal lighting. The two common forms of seining in Nova Scotia are purse seining and Scottish or Danish seining. Although there are some minor differences between Scottish and Danish seining, the safety precautions and procedures are basically the same.

### ■ Working on deck

When working on the deck of a seining vessel, there are a number of dangers and safety precautions.

#### Danger

Falling overboard.

Hearing damage from loud noise, especially during the launching and retrieving of the skiff and gear.

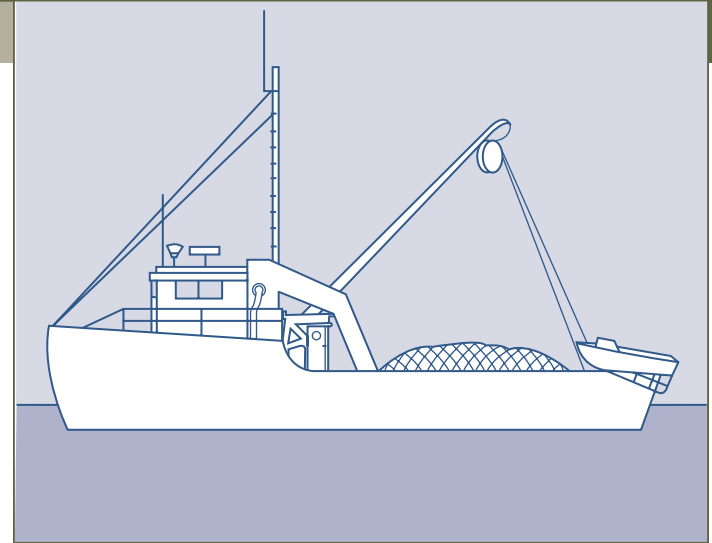

Getting hit by a falling object or moving equipment, including power blocks, lead lines, and booms that are suspended over the deck.

Getting bitten or cut by fish flopping around on the deck.

Precaution Wear a PFD , hearing protection, and a hard hat.



Precaution Wear gloves and eye protection. Watch for particularly active fish. Also, be careful of glass or sharp rocks that may have been caught in the net.



Check equipment regularly:

Make sure the power block is attached to a safety line.

Make sure the winch cables are in good working order.

Repair or replace any equipment or gear that is worn, broken, or otherwise unable to serve its purpose properly.

## ■ Setting and hauling the gear

Danger Getting an arm or leg caught in the bight of a rope, warping head, or winch drum.

Hauling in a catch that is too large. The extra weight on the side may be too much for the boat's stabilizers to offset. This could cause the boat to list.

Getting a hand, arm, or leg stuck in a winch drum while hauling in the catch.

Getting an arm or leg caught in the pump nozzle.

Falling into the fish holds in the hull.

**Precaution** Stand clear of the main warps and the net as they are set out and hauled in. Only the operators of the winch and ropes should be on the deck at this time, and they should have a clear view of the gear at all times.

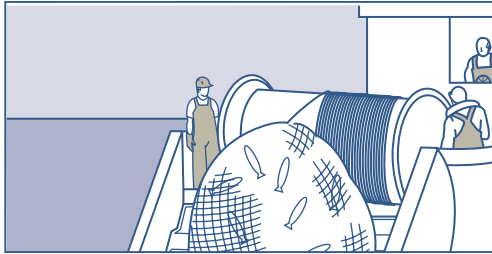

**Precaution** If the boat is listing because of the weight of the catch, the only option is to cut the net.

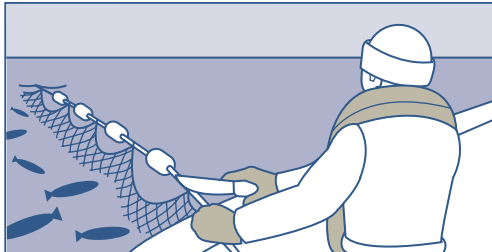

**Precaution** Stay clear of the drum or roller unless you are the operator.

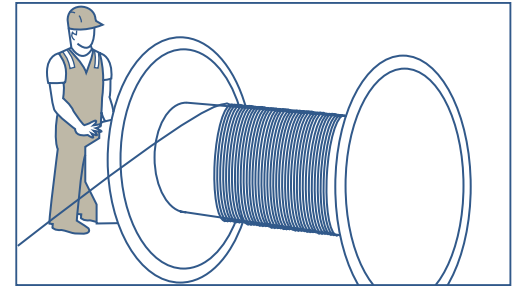

**Precaution** Stand clear of the nozzle unless you are part of the crew operating the pump and nozzle.

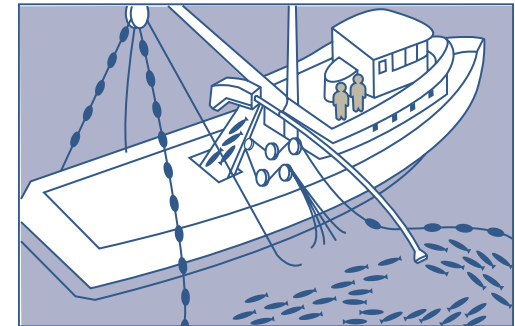

Precaution Always secure the hatches covering the fish holds when they are not in use.

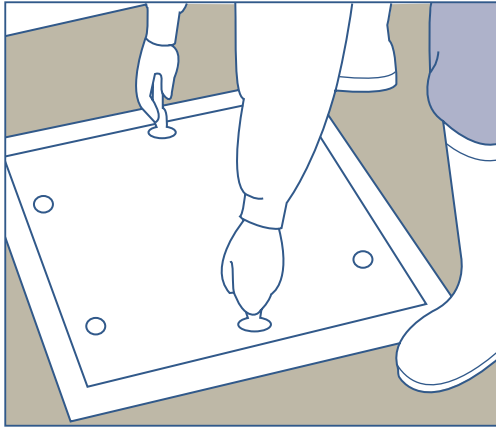

## ■ Using a skiff

Skiffs are used in purse seining. The skiff operator must be properly trained in the operation of the skiff.

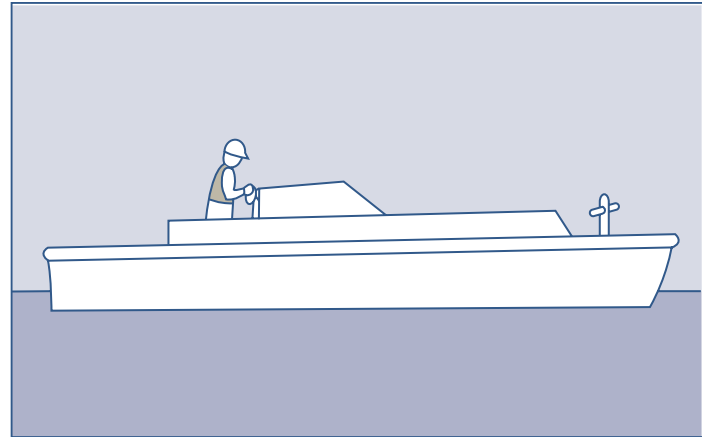

**Danger**

Getting caught between the skiff and the vessel.

Falling out of the skiff.

Having the skiff capsize from tension in the net as the gear is being set.

Having a skiff shift and cause damage to the vessel or add extra weight onto one side causing the boat to list.

Having a crew member get knocked overboard while launching the skiff.

**Precaution**

When boarding the skiff, use a three-point boarding procedure. Always have at least two hands and one foot or one hand and two feet on the skiff or vessel.

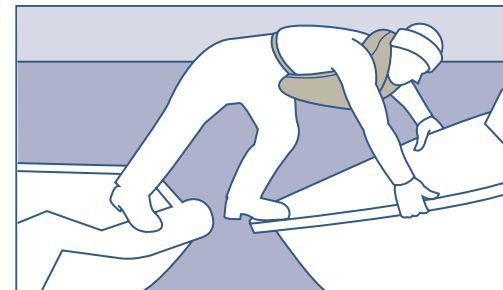
**Precaution**

Wear a PFD. Don't lean over the side of the skiff.





Precaution Before turning the skiff to tow, make sure a good portion of the net is in the water.

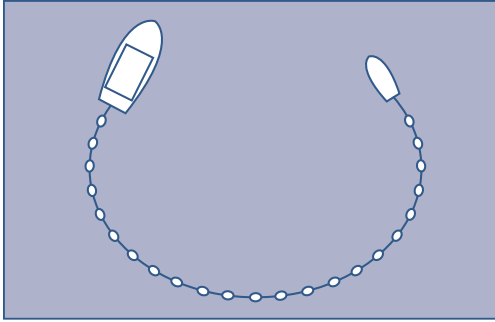

Precaution Stay clear of the skiff unless you are the skiff's operator.

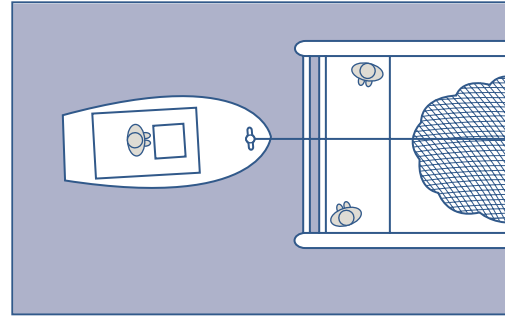

Precaution Secure the skiff with more than a winch line.

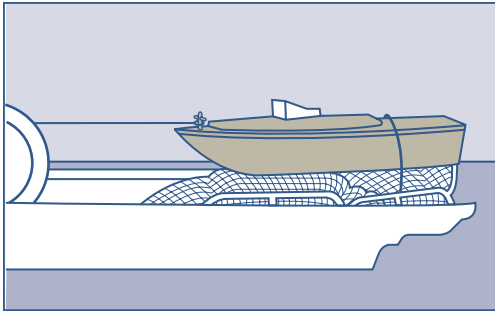

## Gillnetting

Like other fishing methods, most of the danger involved in gillnetting occurs when launching and hauling in the gear. In many smaller operations, the gill net is hauled in by the crew. Larger operations use a mechanical power drum to haul in the net.

### ■ Launching and hauling the net

- Danger**      Getting hauled overboard if feet or clothing are caught in net.
- Getting hit by moving buoys, sinkers, or other equipment.
- Getting hit by falling or moving objects.
- Getting cut by ropes, gear, or knives.

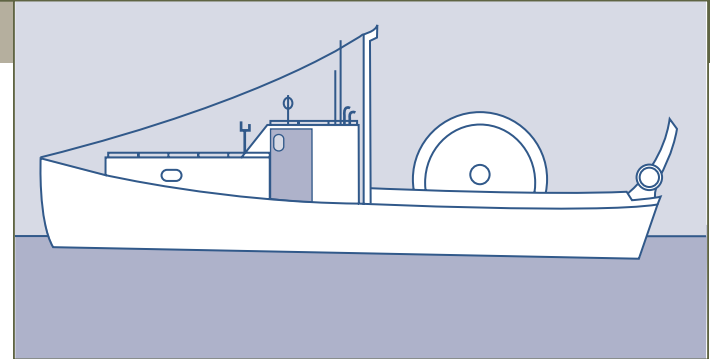

**Precaution**      Wear safety boots—sinkers could fall on your toes.



**Precaution**      Wear a PFD, eye protection, and gloves.



**Precaution** Watch for buoys (floats) or sinkers as they go over the bulwark. They can give a nasty bump if they strike you.

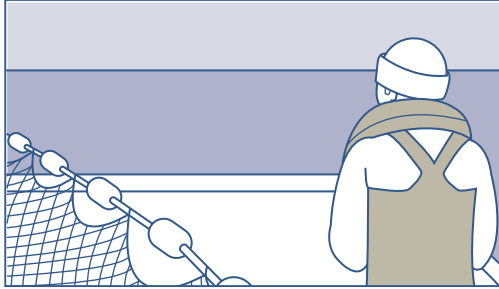

**Precaution** Don't wear loose-fitting clothing or jewellery. It can get caught in the net as it is launched.

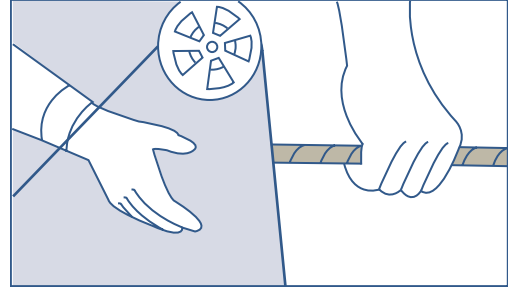

**Precaution** Keep your feet clear of the net.

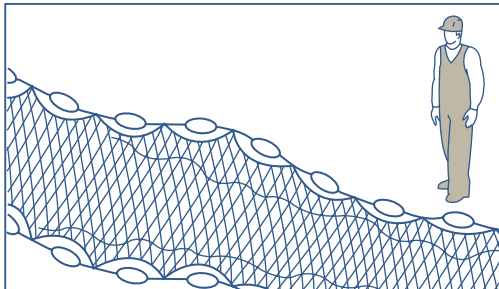

**Precaution** Keep a sharp knife available to cut snags in the net. Store the knife in a sheath or on a rack with the blade pointing down.



## ■ Using a power drum

Danger Items falling on head.

Precaution Stay off the deck unless you are a necessary part of the operation, such as the drum operator.

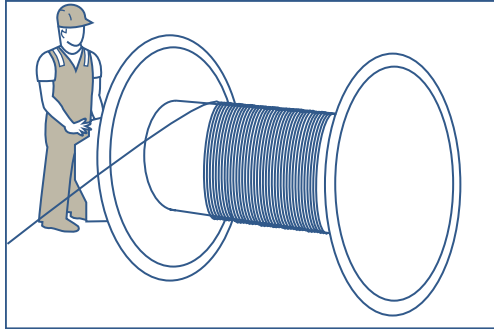

Precaution Wear a hard hat on deck while the hauling is in progress.



## ■ Removing fish from the net

**Danger** Fish may bite or have sharp fins or spines. Dogfish, in particular, have a sharp, horn-like bone that protrudes from their dorsal fin.

Slipping, tripping, and falling on slippery deck.

**Precaution** Only the crew members involved in the unloading process should be on the deck.

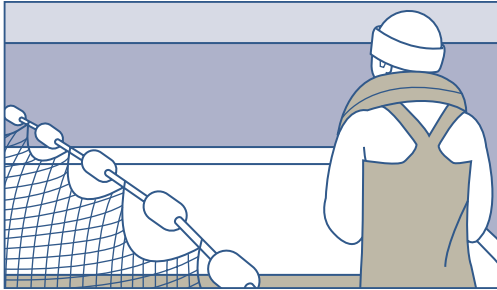

**Precaution** Wear gloves when handling the catch.



**Precaution** Have the tote boxes or freezer boxes close at hand to increase your work efficiency and minimize reaching, slipping, tripping, and falling.

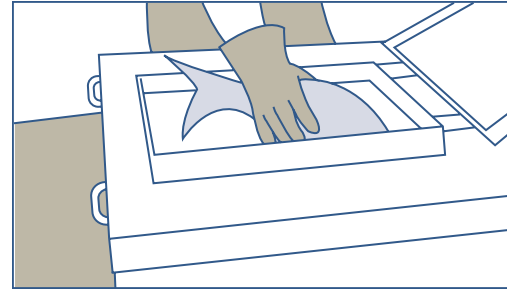

**Precaution** Pick up any fish that may fall onto the deck. The slime on their bodies will make the deck slippery.

## ■ Equipment safety

**Precaution** Visually inspect the equipment and gear before it is set. Replace anything that has flaws or excessive wear and tear.

**Inspection checklist:**

- Ropes or bridles: Not frayed or worn out.

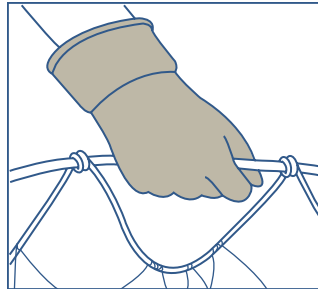

- Nets: Free of tangles and snags.

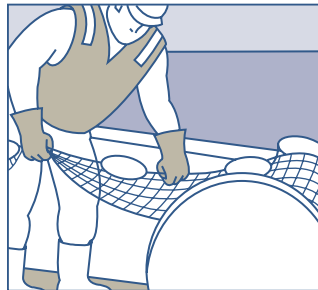

- Hold-to-run control on power drum: In good working order.

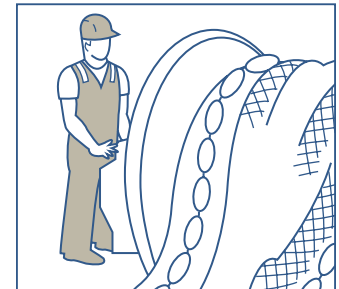

- Tote boxes and freezer boxes: Clean.

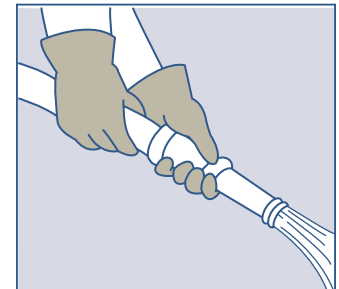

## Longlining

Longlining is generally less mechanized than other fishing methods with smaller crews. This does not mean that hook-and-line fishing is less dangerous. The greatest danger to a person in longlining is falling overboard.

- Danger**
- Falling overboard when hauling in a large fish.
  - Getting cut while baiting a hook.
  - Getting bitten or cut by an aggressive species of fish, such as catfish, shark, or barracuda.
  - Getting hit by the anchor or a highflier.

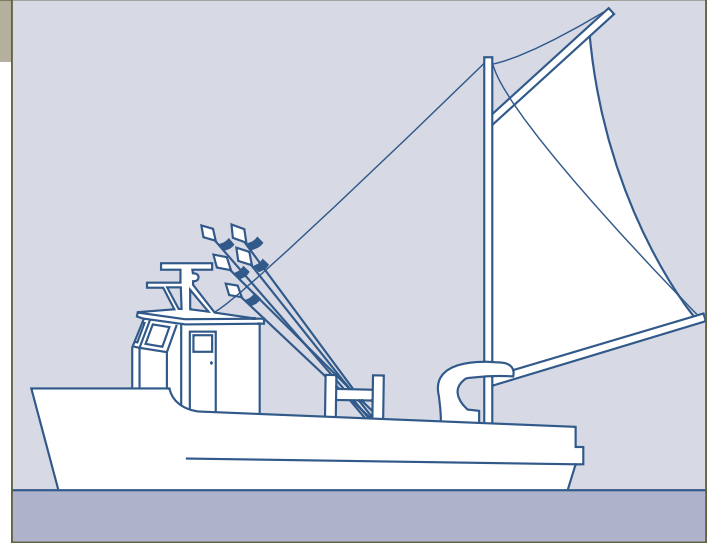

- Precaution**
- Wear a PFD and some form of fall protection, such as a safety line.



**Precaution** Learn the proper technique for baiting the different types of hooks to avoid injury. Although gloves would provide protection from cuts, they don't allow for the dexterity needed to bait the hook.

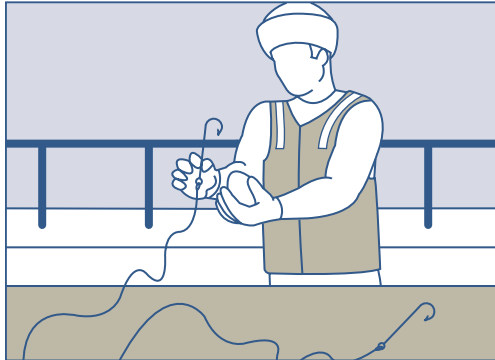

**Precaution** Protect the eyes with safety glasses or goggles.



**Precaution** Watch the fish on the line carefully as they come out of the water.

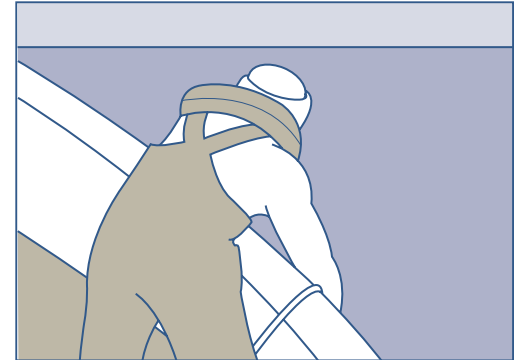

**Precaution** Wear a hard hat and foot protection. All crew members should be aware that the gear is being set.





## ■ Monofilament

### Danger

Getting cut while cutting the baitfish, baiting a hook, or working with the line.

Getting bitten by a shark or other dangerous fish.

Getting a finger or hand stuck in the drum or in the ganging snaps.

Getting hit by a high tension line that snaps and recoils.

Tripping on the line.

### Precaution

Bait the hooks before setting the line.

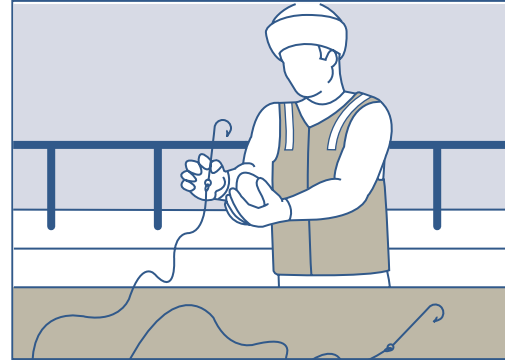

### Precaution

Watch for danger as the fish on the line comes out of the water.



Precaution Keep hands a safe distance from the drum.

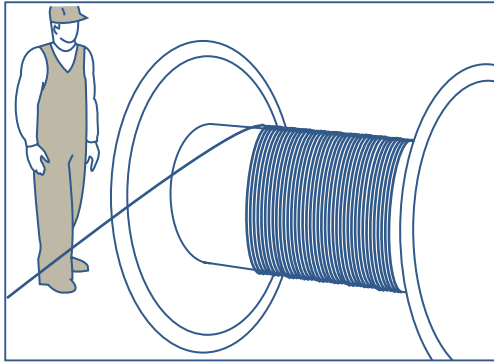

Precaution Be aware of the dangers of working around the high tension line used in monofilament longlining: the line could snap and recoil, or you could trip or cut yourself on the line.

## ■ Handlining, trolling, and kite fishing

Danger Falling overboard or getting hauled in by a large fish.

Getting blisters and cuts on the hands from constant holding and gripping the rod.

Getting electrocuted by lightning hitting the kite or line.

Precaution Wear gloves and use a safety line.

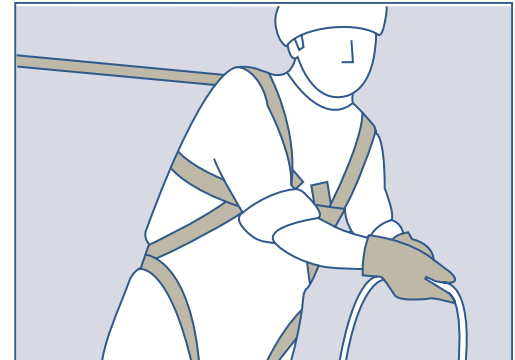

Precaution Use a seat belt or safety line to restrain yourself.

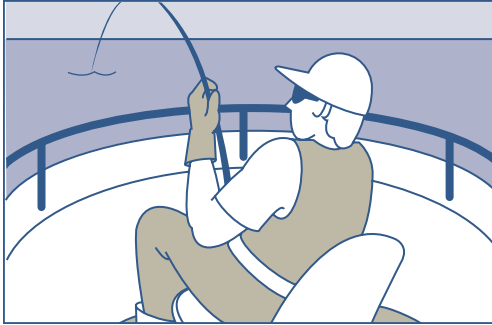

Precaution Don't kite fish in an electrical storm. You will be a target for a lightning strike.

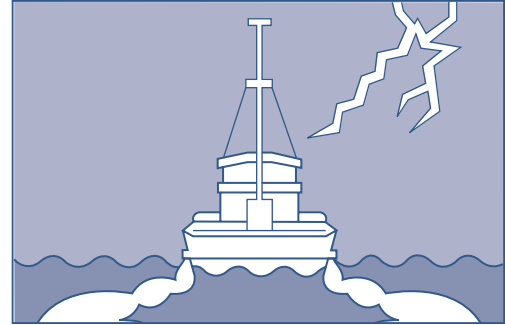

## Section 3: Aquaculture



Aquaculture is relatively new as a viable commercial industry in Nova Scotia. Although first used here to supplement existing species and increase fish populations, aquaculture farms have now become necessary to meet the public's demand for seafood.

Nova Scotia's aquaculture industry is one of the most diverse in Canada. We cultivate many different species of finfish and shellfish, as well as Irish moss and other sea plants. The most commonly cultured finfish are Atlantic salmon and steelhead (rainbow) trout, but we also produce flounder, halibut, cod, and Arctic char. For shellfish, mussels and oysters top the list. Other farmed species include eels, sea scallops, quahaugs, and clams.

## Aquaculture Safety

Aquaculture workplaces vary a great deal. The physical attributes of the water and shoreline affect how the workplace is set up. But every worker at an aquaculture site is exposed to certain dangers, regardless of the size, location, or type of farm.

### Prepare for workplace hazards

Aquaculture is generally a year-round venture that requires frequent visits to the cultivation areas, especially finfish farms where regular feeding is necessary. The three main risks are described below.

### ■ Drowning

The number one safety concern for workers in the aquaculture industry is drowning. Always wear a personal flotation device (PFD) when working in a boat, on a cage structure, or on a barge.

#### Danger

Falling into the water while boarding or exiting a boat.

Gathering the socks, nets, and lines of shellfish.

Maintaining and building cage structures

**Precaution** Always board a boat by way of a gangway or ladder when it is available. For smaller boats and punts that are boarded directly from the shore or small wharf, secure the boat so it doesn't shift or move while one foot is in the boat and the other is on shore.

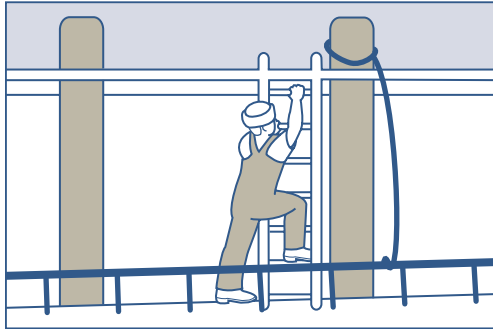

**Precaution** Establish good balance in the boat. Never reach too far.

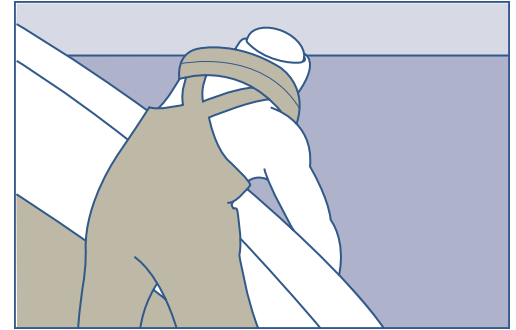

**Precaution** Wear boots or shoes with good traction. The cage structures can get slippery, especially as algae and other sea plants start to grow on them.



**Precaution** While walking around the cage structure, keep one hand on the rail at all times, using a cross-over method.



**Danger** Having a piece of the cage structure break, landing you in the water.

**Precaution** Make sure the rails and bottoms of the cage structures are not loose at the connections or broken in any spot. Always check the integrity of a cage structure after a storm or after it has been frozen in the ice.

**Precaution** Carry tools in a tool pouch, not your hands.

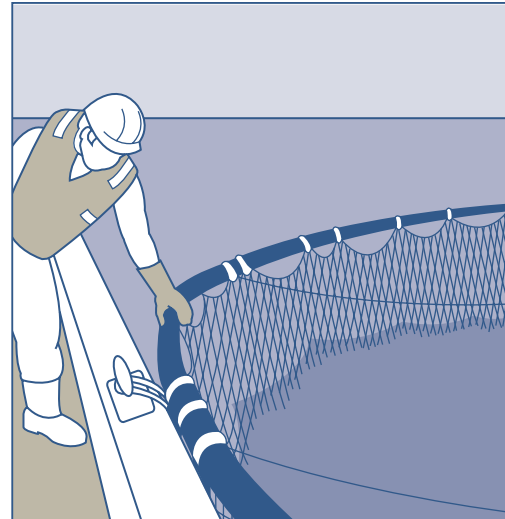
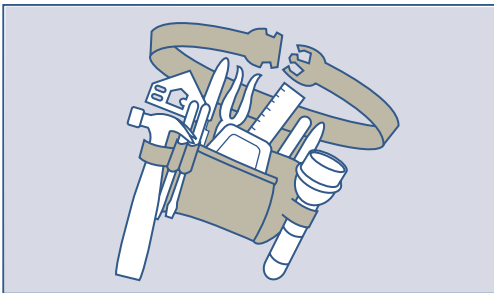

Danger

Falling off a barge.

Precaution

Have a rail surrounding the barge. Don't overextend to grab a piece of gear or equipment.

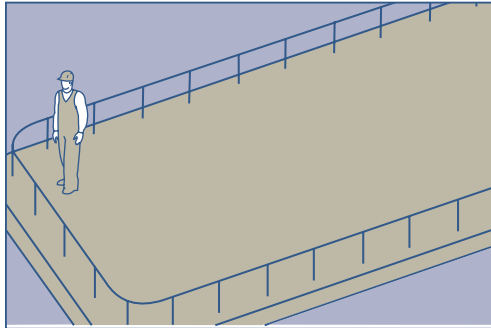

## ■ Hypothermia

Although a PFD will keep you above the surface of the water, it will not protect you from the elements, in particular frigid water.

Danger

Hypothermia can occur within minutes of entering the water, with death soon after.

Precaution

When water is extremely cold and the risk of falling in is high, wear a floater suit or other survival gear. The extra minutes the suit can keep you alive may allow time for a rescue.

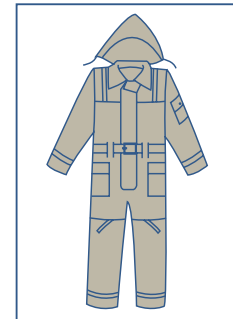



**Precaution** Whenever possible, work in pairs or groups.

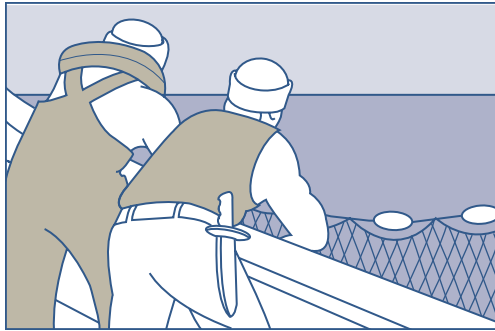

*Note:* Hypothermia can occur in all seasons and can occur even if a person has not fallen into the water. Reduce the chance of hypothermia by wearing warm clothing and keeping your head and extremities covered.

## ■ Heat-related injuries

Exposure to the heat and sun during the hot summer months causes many problems for aquaculture workers. Protect yourself from the hazards of heat and direct sunlight.

**Danger** Sunburn and sunstroke.

**Precaution** Wear sunscreen. Direct sunlight at anytime of the year can cause sunburn.

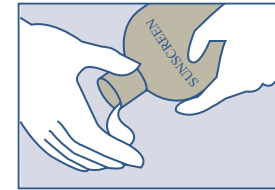

Wear a hat that keeps the direct sunlight off your head and face.



**Precaution** Wear sunglasses to protect the eyes from direct sunlight or the glare off the water. Sunglasses should not be used as a replacement for safety glasses when performing tasks that require the use of eye protection.



**Danger** Dehydration and heat exhaustion.

**Precaution** Drink lots of fluids, especially water. Limit coffee and pop that contain caffeine—they increase fluid loss, as does alcohol.



**Precaution** Take frequent, short breaks instead of infrequent, long breaks.



## ■ Have a communication plan

Drowning is the biggest risk aquaculture workers face. When someone has an accident on the water, they need help quickly. Yet in many smaller operations, especially where shellfish are being cultivated, workers often work alone. A communication plan is an essential safety precaution for every aquaculture operation.

Workers may need to get help from the shore to the farm, quickly, at any time. Have a means of communication available to each worker and safety procedures in place. Cell phones, beepers, and two-way radios are very good. Even hand signals and voice (yelling) can work as a last resort. Flares can also be used to signal an emergency. Have a plan, equip the workers with communication devices, and train them in emergency procedures.

A basic safety precaution when taking a boat out to a barge or harvest area is to make sure somebody on shore knows. Make this kind of communication routine procedure at your workplace by equipping every worker with a cell phone or beeper or installing two-way radios. Also, train workers to use standard hand signals, distress calls, and flares in an emergency.

Have a communication plan in place that accounts for all the workers at the workplace at all times.

## Common Aquaculture Hazards

Workplaces in the aquaculture industry are continually being upgraded to take advantage of technological advances. This means there will be variety in how workplaces operate. Although each aquaculture site is unique, some safety issues are common to all sites.

Aquaculture sites in Nova Scotia are divided into two areas: a harvest/cultivation area where the actual farming is done and a shore area where administration and processing are done. Food, nutrients, equipment, supplies, and workers are constantly being transported between the two. This is done mainly by boat or barge.

### ■ Small boat safety

The size and type of boat used to transport equipment, supplies, and workers depend on the size of the operation, the distance between the shore and the cultivation areas, and the amount of material being transported. Skiffs equipped with outboard motors often serve this purpose. Most aquaculture sites, especially shellfish operations, use a small boat at some point. Aquaculture workers must be aware of small boat safety and the regulations regarding small boats.

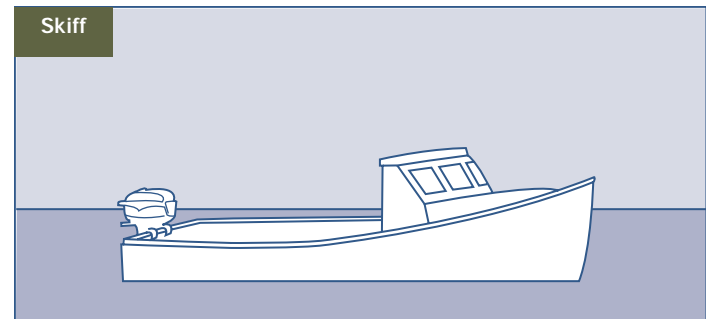

Danger Listing or capsizing.

Precautions Never overload a boat. If there are too many people or there is too much equipment or supplies for the boat, make two or more trips.

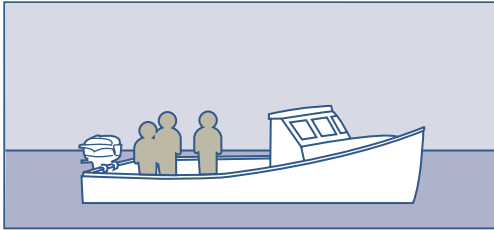

Load equipment evenly throughout the boat. Do not depend on people to counter-balance the weight of equipment and supplies.

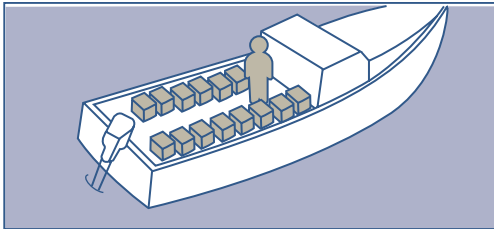

Danger Getting hit by lightning.

Precaution Never take a boat out in an electrical storm. If a storm comes up when you are on the water, land as quickly as you can. Lightning will most often strike the highest object around. Your boat will be a target.

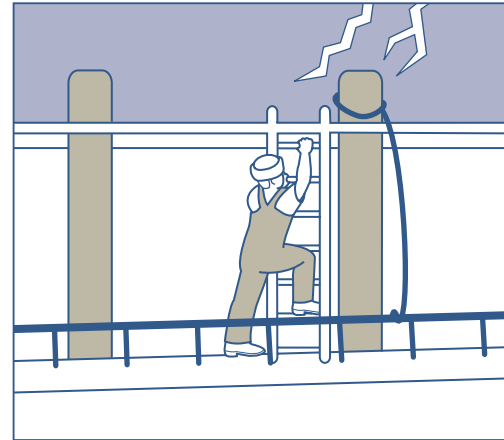

## ■ Barge safety

Barges share many of the same safety hazards as a fishing vessel.

**Danger** Winches are often used to haul gear and nets.

Fire hazards associated with the fuel for the engines that run the barge. There may also be propane or acetylene tanks when repairs or modifications are being done.

### Winch safety

Dangers associated with a winch include

- Getting a hand or foot stuck in the winch drum as it hauls back the gear or skiff.
- Getting hit by a broken line as it recoils.
- Tripping over a line.

**Danger** Lines can break and snap back.

Items dropping on workers.

Getting caught in gear.

**Precaution** Stay away from both the drum and the line when the winch or hoist are in operation.

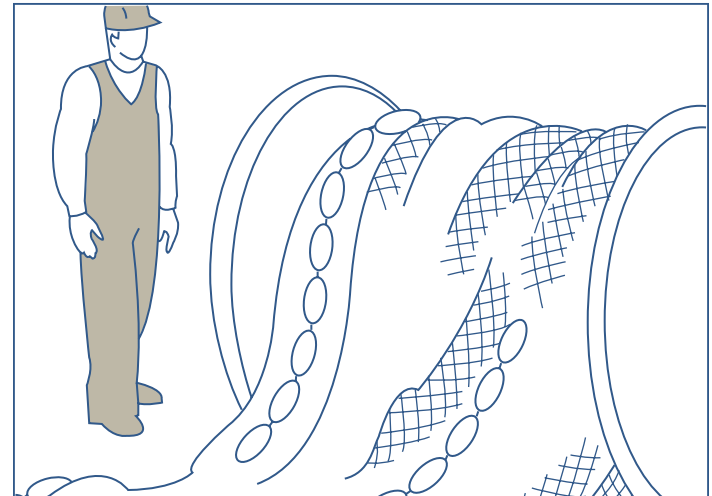

**Precaution** Inspect the winch and hoisting systems regularly to ensure that it works properly and is not damaged or otherwise in need of service.

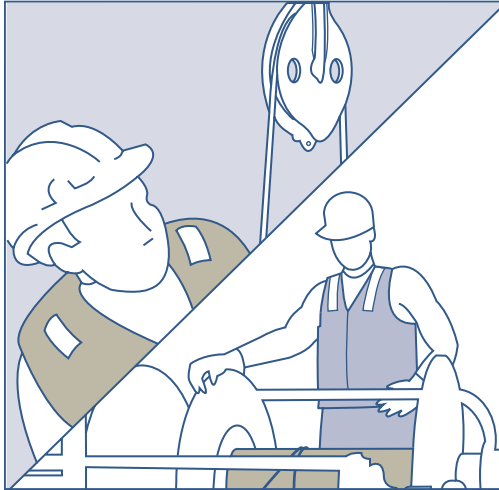

**Danger** Fire.

**Precaution** Keep engine fuel containers and compressed gas tanks stored properly, away from sources of ignition.

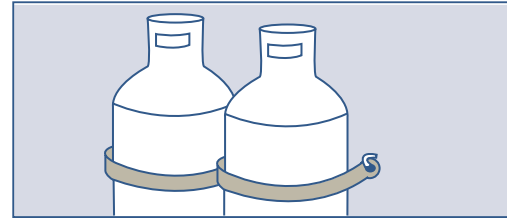

**Precaution** When there is an odour of fuel or gas, stop any hot work immediately and don't continue until the source of the fumes has been identified and procedures taken to fix the situation.

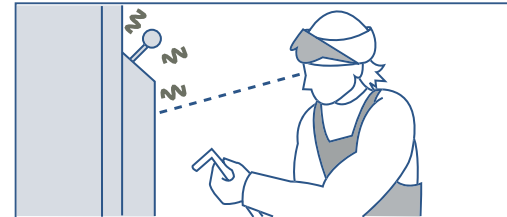

Precaution Keep an ABC class fire extinguisher in an accessible spot on the barge.



Danger Listing or capsizing.

Precaution Secure the supplies and equipment being carried. Shifting weight can cause stability and buoyancy problems with the barge.

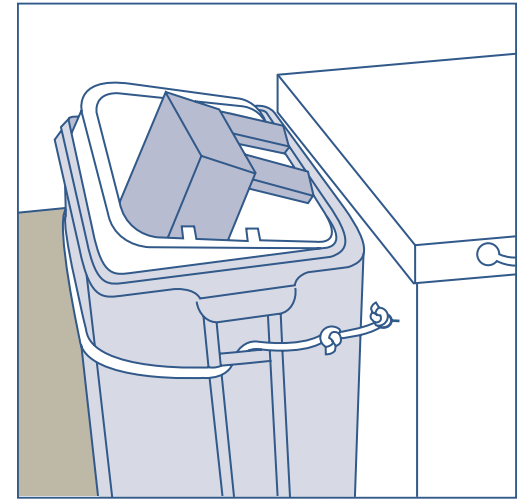



**Danger** Drifting.  
If the barge drifts during certain operations, this may put extra strain on equipment, such as the boom winch. Equipment could shift and lines could break, injuring nearby workers.

**Precaution** Properly anchor the barge.

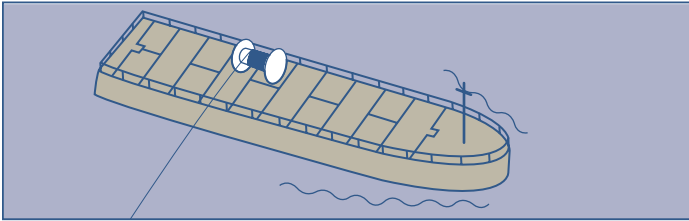

**Danger** A drifting barge could pose a navigation hazard to other vessels, causing collisions that endanger both crews.

**Precaution** Properly anchor the barge.

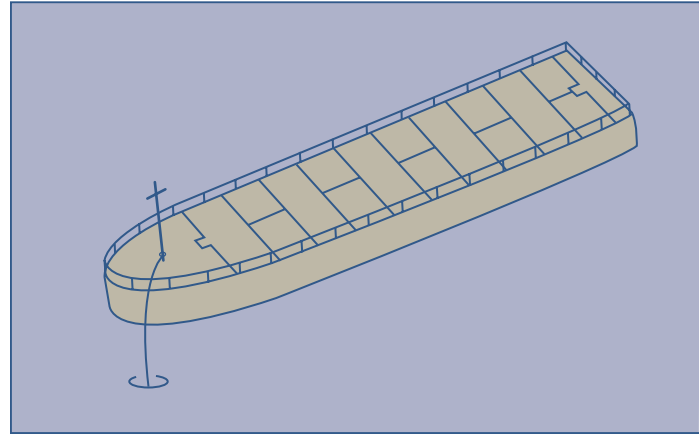

## ■ Cage structure safety

A cage structure is a plastic or metal square cage 15 m X 15 m, or a circular plastic cage from 40 to 100 m in circumference used to enclose the farmed species. The cage structure supports a net that keeps the fish within the confines of the structure.

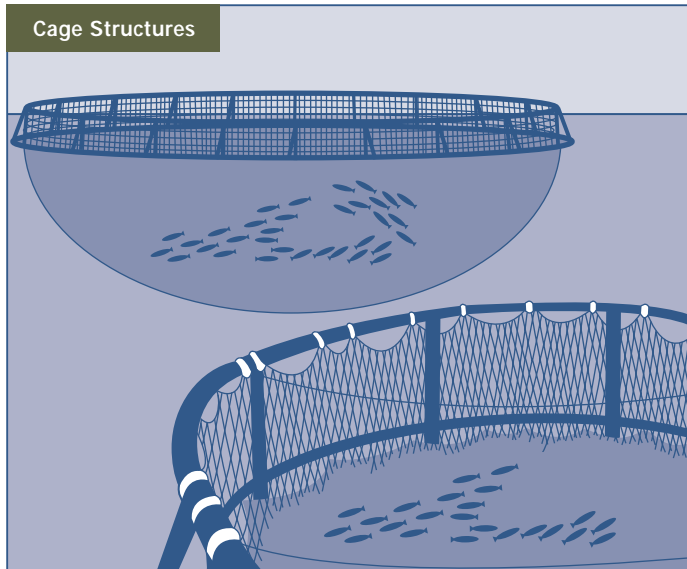

Two other nets are often applied to the cage structures to protect against predators. A bird net covers the fish until they are large enough that sea gulls, cormorants, and herons cannot harm them. A predator net attaches to the apron of the cage structure to surround and protect the fish from animals such as seals.

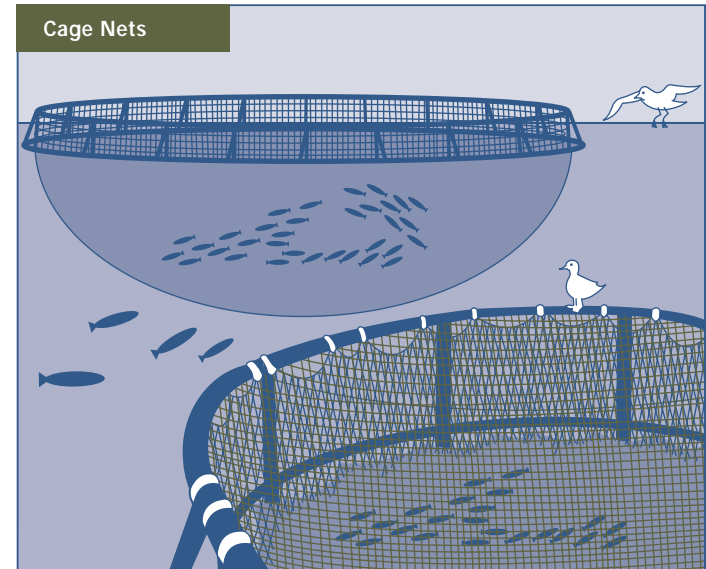

**Danger** Falling into the water while maintaining the cage structure or installing or retrieving nets.

**Precaution** Wear a PFD.



**Danger** Getting caught in the net or net reel during net changes.

**Precaution** Stay clear of the net reel when it is in operation. The net reel on the boat or barge uses hydraulic power to roll the net as it is retrieved.

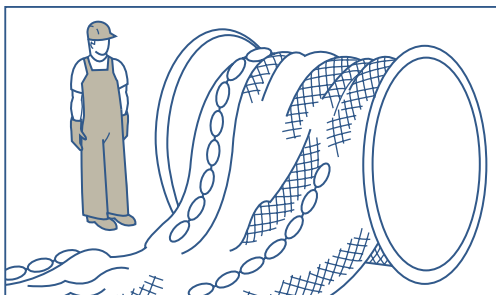

## ■ Net and line safety

Aquaculture sites have many lines and nets extending from the surface of the water to various depths. Although the lines and nets are marked with buoys and anchored with sinkers, the tide and current may move the lines or nets enough that their position may change slightly from day to day.

**Danger** The lines and nets can get entangled around the outboard motor, causing the boat to lurch.

A line may be cut by the propeller and snap back.

**Precaution** Take care when operating the skiff in the farm, especially in rough water.

In terms of safety, the biggest concern with lines and nets occurs during diving operations. Diving operations should be well planned, and the divers should only perform the planned tasks in the planned area.

**Danger** Limited visibility. If the diver can't see well, it is easier to get caught in nearby nets.

**Precaution** The safest plan is to wait until conditions improve. If you can't wait, take special care to have all the safety precautions in place—a diver tender on the surface, a second diver nearby, and a dive knife to hand.

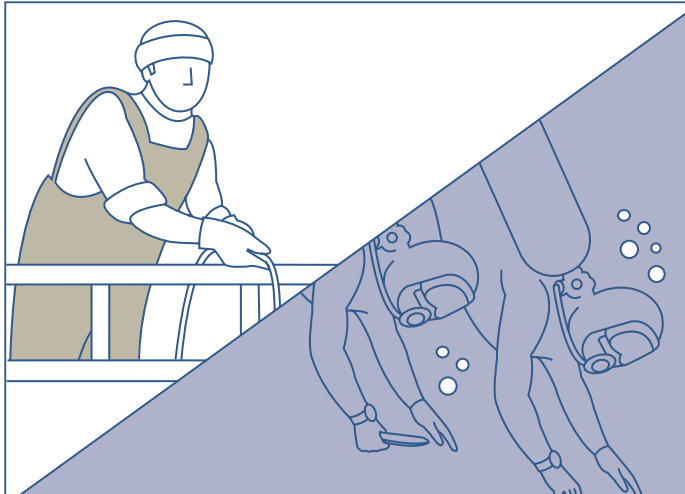

## ■ Diver safety

All aquaculture operations require the use of divers at some point. In finfish operations, divers may be used to help set up and dismantle cage structures, inspect and repair nets, or remove dead and unhealthy fish. In shellfish operations, divers may be used to inspect the sleeves, anchors, and general conditions of the shellfish at the site, as well as for harvesting.

Operators use either contracted divers or in-house workers to do the diving. In either case, divers must be certified and have sufficient knowledge of the tasks they will be required to perform.

**Danger** Running out of air—self-contained breathing apparatus (SCUBA) gear provides protection for a limited amount of time.

Getting caught in the nets or tangled in a line.

Precaution Never dive alone. Have a second diver and a diver tender on site.

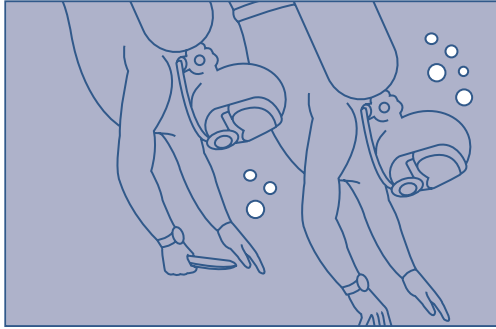

Precaution Make sure diving gear is in proper working order and has an adequate amount of air. Make sure tank inspections are up to date.

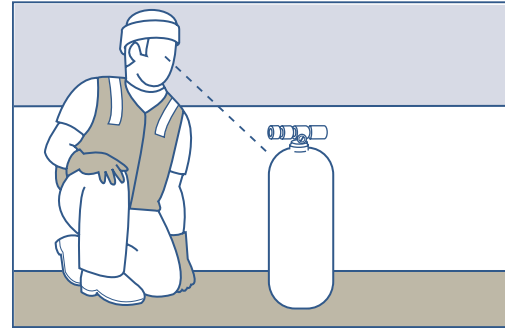

Precaution Have a system of communication, such as a tug on a line, to be brought up.

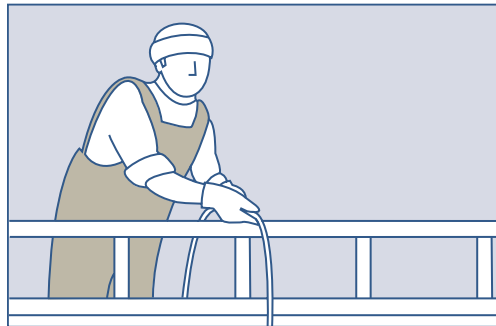

## ■ Harvesting safety

The amount and frequency of feeding in finfish aquaculture operations vary depending on the size of the fish, the time of the year, and the conditions of the water. However, more time is spent feeding the fish than any other non-administrative aspect of finfish farming. Therefore, safety when feeding the fish is extremely important.

### Docking the boat or barge

**Danger** A hand or arm could get caught and crushed between the boat and the rail.

**Precaution** When the boat pulls alongside the cage structure, take care when reaching the rail to tie the boat off.

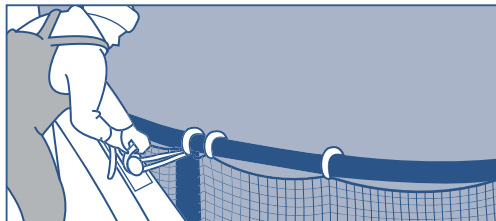

Exiting the boat and walking on the cage structure's apron

Many finfish farms use underwater cameras to monitor the fish as they are being fed. A person may need to climb on the cage structure to lower the camera in an area away from where the boat is tied.

**Danger** Falling into water and drowning.

**Precaution** When exiting the boat, always have one hand on the rail of the cage structure. Wear a PFD.



### Operating the feed blower

Feed blowers vary in size but basically operate the same way. A hopper is filled with feed and a fan creates a draft that shoots the feed through tube and over the cage.

**Danger** Hearing damage from noisy equipment.

**Precaution** Wear hearing protection when operating feed blowers.



**Danger** Getting a hand or clothing caught in equipment.

**Precaution** Never put your hand in the hopper if the blower is in operation. Don't wear baggy clothing.

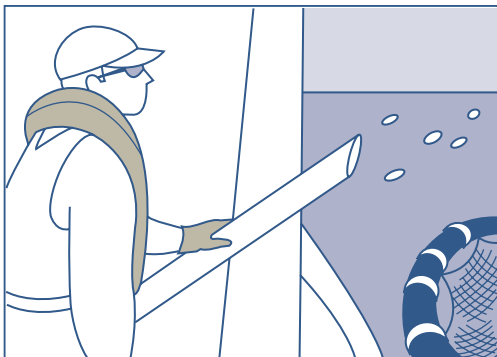

**Cleaning up to avoid slipping**

**Danger** Slipping on plastic feed bags, especially when they are wet or icy, and landing in the water.

**Precaution** Clean up feed bags immediately to keep slipping hazard to a minimum. A tidy boat and barge will be a safer workplace.







## For More Information

This handbook, Fish Safe, has given an overview of how we can work together to improve our safety record. If you would like further copies of this handbook, please contact

Nova Scotia Fisheries Sector Council  
1-902-742-6167

For further information on occupational health and safety in the fishing industry, please contact

Nova Scotia Environment and Labour  
1-800-952-2687

Transport Canada - Marine Safety  
SYDNEY OFFICE

Federal Arts Bldg., 2nd Floor  
196 George Street  
Sydney, NS , B1P 1J3  
Tel: (902) 564-7002 Fax: (902) 564-7648

YARMOUTH OFFICE

PO Box 850  
248 Pleasant Street  
Yarmouth, Nova Scotia, B5A 4K5  
Tel: (902) 742-6860 Fax: (902) 742-6866

DARTMOUTH OFFICE

45 Alderney Drive, 14th Floor  
Queen Square, PO Box 1013  
Dartmouth, Nova Scotia, B2Y 4K2  
Tel: (902) 426-9321 Fax: (902) 426-6657

PORT HAWKESBURY OFFICE

811 Reeves Street, Unit 1  
Port Hawkesbury, Nova Scotia, B9A 2S4  
Tel: (902) 625-0803 Fax: (902) 625-1722