

A Vermicomposting Guide for Teachers

State of California

Arnold Schwarzenegger
Governor

Terry Tamminen
Secretary, California Environmental
Protection Agency

California Integrated Waste Management Board

Linda Moulton-Patterson, Chair
Michael Papanian, Member
Rosario Marin, Member
Rosalie Mulé, Member
Cheryl Peace, Member
Carl Washington, Member

Mark Leary, Executive Director

Revised June 2004

For additional copies of this publication, contact the California Integrated Waste Management Board (CIWMB), Office of Education and the Environment, at (916) 341-6769. You can download the entire guide from our website at www.ciwmb.ca.gov/Schools/Curriculum/Worms/.

The CIWMB does not discriminate on the basis of disability in access to its programs. CIWMB publications are available in accessible formats upon request by calling the Public Affairs Office at (916) 341-6300. Persons with hearing impairments can reach the CIWMB through the California Relay Service, 1-800-735-2929.

Publication #560-01-007

Copyright © 2001, 2004 by the California Integrated Waste Management Board. All rights reserved. This publication, or parts thereof, may not be reproduced in any form without permission.

No worms were injured in the preparation of this guide.

Acknowledgements

This guide was written by Tavia Pagan and Rachelle Steen of the Office of Education and the Environment at the California Integrated Waste Management Board. Many other brave souls were involved in various aspects of creating this guide, so a big “thanks” goes out to the following people for all of their contributions: Oscar Arriaga, Terry Brennan, Yvette DiCarlo, Cynthia Havstad, Chris Kinsella, Pauline Lawrence, Deni Lopez, Kyle Price, Alana Sanchez, Valorie Shatynski, Tessa Troyan, Kelli Wessman, Becky Williams, and Betty Wong.

Disclaimer

The identification of individuals, companies, and products in these materials does not constitute endorsement by the California Integrated Waste Management Board (CIWMB) and is provided for informational purposes only. The CIWMB is distributing this information in an effort to increase public awareness and knowledge about this important topic.

In addition, this guide showcases a few ways to start and maintain a worm bin, but there are more options in vermicomposting than are included in this document.

The energy challenge facing California is real. Every Californian needs to take immediate action to reduce energy consumption. For a list of simple ways you can reduce demand and cut your energy costs, Flex Your Power and visit www.consumerenergycenter.org/flex/index.html.

Mission

The mission of the California Integrated Waste Management Board (CIWMB) is to reduce the generation and improve the management of solid waste in California in order to conserve resources, develop sustainable recycling markets, and protect public health and safety and the environment. We do this in partnership with public agencies, industry, business, and the public we serve.

In pursuing the above mission, CIWMB promotes the utilization of recovered materials (materials that would otherwise have been discarded, such as paper or aluminum cans). Vermicomposting deals with one recovered material in particular: food waste.

Assistance

The CIWMB has representatives to assist schools with a variety of issues including vermicomposting, school reuse and recycling programs, and environmental curricula that focus on resource conservation and waste management.

If you are interested in recycling information or would like to start a school waste diversion program, please contact the CIWMB's Office of Local Assistance at (916) 341-6199. For education resources our Office of Education and the Environment can help you (contact information is below).

To contact the CIWMB's Office of Education and the Environment, call us at (916) 341-6769, or write to us at CIWMB / Office of Education and the Environment, Mail Stop #14-A / P.O. Box 4025 / Sacramento, California 95812-4025. We also encourage you to visit our website at www.ciwmb.ca.gov/Schools/ for more information about our programs.

Table of Contents

○ Integrated Waste Management	p1	○ Case Studies	p24
		Davis Joint Unified School District Food Waste Diversion Project	p24
○ Basics of Vermicomposting	p2	Making a Difference: One Piece of Paper at a Time (Park View Center School)	p28
Bin	p2	Garden of Learning (Louisiana Schnell Elementary School)	p30
Bedding	p3		
Worms	p4		
Feeding	p5		
Harvesting	p7	○ Appendices	
Troubleshooting	p8	Appendix A: Educational Materials	p32
Biology	p9	Appendix B: Web Sources	p32
		Appendix C: Reuse Options	p34
○ Other Worm Bin Residents	p10	Appendix D: Worm Bin Options	p37
○ The Garden Connection	p12		
○ Closing the Food Loop at Your School	p13		
○ Fundraising	p15		
○ Activities for the Classroom	p16		
My Worm Biography	p16		
_____ the Worm	p17		
My Worm Story and Picture Book	p18		
Activities by Subject	p22		
The Adventures of Vermi the Worm!	p23		

Integrated Waste Management

At the very heart of waste management is the integrated waste management hierarchy—reduce, reuse, and recycle. Many people have added a fourth component to the hierarchy—rot—in order to further eliminate waste from entering the landfill. The first, and most preferred, option is to **reduce** what you use. Buy items with less packaging, and only buy what you need. That's easy! When you reduce, you save landfill space, valuable agricultural land, natural resources, and money.

The second option is to **reuse** an item that you no longer use or want. The saying "One person's trash is another person's treasure" is true!

Take items that are in good shape to a secondhand store or to other reuse organizations for someone else to use. If you have large quantities of items, you may want to place a free ad on CalMAX, a statewide material exchange program listing wanted or available goods (included in Appendix C). Many items destined for the landfill can easily be repaired or combined with other materials to make new, functional products.

Most of us are familiar with the concept of recycling, but as the third option in the hierarchy, **recycle** is less preferred than reducing and reusing. When materials are recycled, energy and resources are still expended, whereas with the first two options, they would not be. The good news is that when manufacturers use recycled materials to make a new product, they often use fewer natural resources and less energy than if they had used virgin materials. Recycling materials is definitely a better choice than sending them to the landfill. To support recycling efforts, buy back the materials you recycle by purchasing recycled-content products.

Rot refers to recycling food waste and other organic materials through composting or vermicomposting. In

vermicomposting, worms do the "dirty work." The organic materials decompose and are transformed into a nutrient-rich material that can be used-or, in this case, "reused"-as soil amendments and fertilizer. Your plants will thank you!

By reducing, you decrease waste from the start. By reusing, recycling, and allowing food waste to rot into compost, you cycle materials back for another round of use instead of sending them on a one-way road to the landfill. Your solid "waste" has remained a resource.

Integrated Waste Management Hierarchy

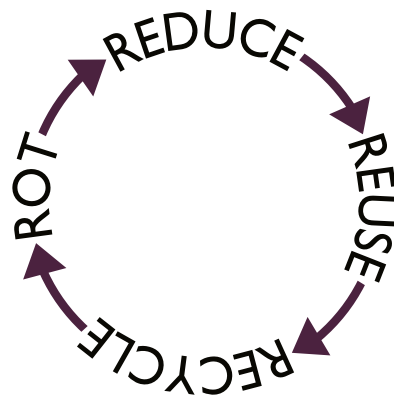

Californians throw away more than 5 million tons of food waste each year! In fact, over 30 percent of California's waste stream consists of compostable organic materials such as wood scraps, yard waste, and food waste.



It is to our advantage to keep these materials out of our landfills, thus saving space and allowing these materials to be reused for other purposes. For example, many waste management facilities utilize organic materials that have been disposed of by turning it into compost. This concept can also be applied on a much smaller scale by composting food waste at school with the help of worms. Using worms to compost helps students understand the process of composting and their role in reducing food waste at their school.

Basics of Vermicomposting

Vermicomposting is the process of using worms (“vermi” is Latin for “worm”) to process organic food waste into nutrient-rich soil. Worms eat decaying food waste and produce vermicompost, a very effective soil amendment.

Worm poop is the best compost! It is full of beneficial microbes and nutrients, and is a great plant fertilizer. Let’s just use the fancy name for worm poop—“castings”—as we discover how you can teach your students about waste management by using worms.

As an educator, you are faced with the challenge of teaching various concepts to your students, like natural cycles and nutrition, while making it fun and interactive. If there is a compost pile at your school, you can teach these concepts in a visual, hands-on manner. If your school has a garden, you can take the lessons a step further. But, how can you take a hands-on approach to teaching cycles and nutrition if you don’t have either of these? The answer is both easy and fun—make a classroom worm bin! Since a worm bin represents a small ecosystem, it is a unique teaching tool for you and an interesting way of learning for your students.

So, push up your sleeves and get ready to make some tiny new friends. Your worms will be the most quiet, well-behaved “pets” you have ever had!

Bin Home Sweet Home

First thing’s first. You need a bin! In selecting the right worm bin for your needs, you must first decide how much food waste you want processed and where you plan to store the bin. There are numerous sizes of bins to select from, and they can range from a small shoebox size to a large worm bin “estate.”(Detailed bin assembly instructions are in Appendix D.)

For a classroom worm bin, a small storage container or a medium-size 12-gallon storage tub will do just fine. To process cafeteria food waste, you will need a much larger bin, which should probably be kept outside. Administrators, food service staff, and school grounds staff should all offer input on exactly how large an outdoor bin they are willing to help maintain. It may be best to start small and expand once you have the hang of it.

The options of materials you can use to make a worm bin are only limited by your imagination. Building your own bin allows more flexibility in size and appearance of the bin. It also gives you the opportunity to decorate! There may be a reuse center near you (check Appendix C) where you can buy inexpensive tile, paint, lumber, and many other unique items. Scrap lumber is fairly easy to come by and can be cut to size to build the bin. Wood pallets may be available free from your local grocery or hardware store to make an outside bin. Cinder blocks can also be stacked to form a bin with a piece of plywood used as a lid.

For an easy-to-make bin, use a plastic storage tub. Availability and types of tubs differ from store to store. The best times to find these storage tubs are at the beginning of the school year and during the December holiday season. From this point forward, a “standard bin” will refer to a 12-gallon bin or one that is approximately 21 inches long, 15 inches wide, and 12 inches high.

Whichever size or type of worm bin you choose, there are a few details that must always be considered:

- **Location! Location! Location!** If you plan to keep your bin outside, make sure it is in a place that will not get too hot or too cold. Your worms will be most productive in temperatures between 55° and 77°F. Extreme temperatures below or above this range may be harmful to your worms, so take this into consideration when deciding where you will keep your bin. Generally speaking, your bin will be okay on a patio next to your classroom during the winter months. The bin should be kept in a shady, cool area during the summer months, or brought inside. Kitchens are a convenient place to keep worm bins. Do not place your bin in direct sunlight.
- **Don't forget to breathe!** Using a 1/4- to 1/2-inch drill bit, drill several holes throughout the bottom of the bin to allow for proper airflow. These holes will allow for ventilation and drainage. The worms will stay in the bin because they prefer dark, moist places to dry, lighted places. Vermicomposting is an aerobic activity, needing oxygen. If your bin becomes anaerobic due to insufficient airflow, you will most likely develop an odor problem.
- **Standing on four feet.** “Feet” are also used to prop up the bin for drainage and ventilation. Small wooden blocks or plastic soda-pop bottle lids perform this function well. You will need four of whichever item you choose. Secure each foot 2 to

3 inches from each corner of the bottom of your bin. If you use screws or nails to attach the feet, make sure they are short enough so they will not poke any fingers.

- **Worm Tea.** Place a tray underneath your bin to collect any drainage (“worm tea”). Aluminum oven pans work well and can be purchased inexpensively at your local grocery or discount store. Cafeteria trays also work. If you do not have a tray, you can use a couple of paper grocery bags or a piece of cardboard instead and replace them periodically, placing them into the bin as additional bedding. Any worm tea that may drain from your bin is very nutrient-rich and your houseplants and garden will love it!

- **It's too bright; keep out the light!** Red worms have no eyes and cannot see. They use light-sensitive skin cells concentrated at the front end of their bodies to sense light and move away from it. Choose a bin made of material that is not transparent. Keep a lid on your bin to prevent any light from entering. Your worms will feed on the surface and stay active. If you can only find a transparent bin, improvise by lining the outside of the bin with dark paper to keep any light out.

Bedding

Comfort Piled High

After a long day at work, it's nice to lie down on a comfortable bed, right? That's right! Your worms will agree.

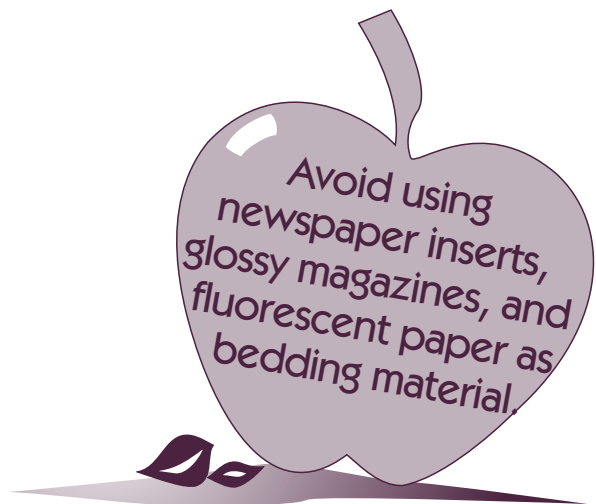

They need bedding inside their bin to keep them comfortable and feeling safe. As always, there are many options for bedding material. One option is peat moss, which can be purchased at any local nursery, but must be leached or it will be too acidic for the worms. Other types of bedding include office paper, coconut fiber, or shredded cardboard or newspaper. When using some of these materials for bedding, you have the opportunity to apply the concept of reuse, instead of discarding the materials. In this guide we will use hand-shredded newspaper because it's easy to obtain and can cost nothing.

The one property the bedding material must have is the ability to absorb water. Worms need a moist environment—their bodies consist of 75 to 90 percent water. Moist bedding allows your worms to stay comfortable and maintain the moisture content inside their bodies. If you notice the contents of the bin tend to dry out, you may want to keep a squirt bottle filled with water near your bin and spray the contents as needed.

To prepare the bedding, collect a small stack of newspaper. Unfold and shred the newspaper into one-inch strips until the bin is approximately two-thirds full. Fluff the newspaper strips to avoid thick clumps. Initially, add several cups of water. Continue to add water and “stir” until all the newspaper strips are thoroughly moist and your bedding material feels like a wrung-out sponge—this is about a 3:1 ratio of water to bedding by weight. Be sure the bedding is not soupy or too dry because these extreme environments will serve as an eviction notice to your worms and they will start looking elsewhere for a new home. The bedding also serves as a medium in which to bury the food waste and prevent odors. Use your

hands to “fluff” the bedding so your worms can move around and air can circulate freely. Now your bin is ready for worms!

Worms

Red Wigglers

You may have already noticed that worms have a lot of special requests. That is because we will be using a special type of worm—*Eisenia foetida*, otherwise known as “red worms,” “manure worms,” or “red wigglers.” These worms are the perfect candidates to inhabit a worm bin, as their main goal in life is to eat decomposing organic matter. Red worms eat organic matter in mass quantities—up to their own weight each day.



Don't mistake these little creatures for “night crawlers,” as red worms and night crawlers are two totally different worm species requiring distinctive environments. Night crawlers need a large area in which to burrow; they are “deep dwellers” that aerate the soil by making tunnels. Red worms, on the other hand, live close to the surface of the soil and do not need a lot of space to burrow. Each worm species will not be happy in the other's environment, and may even die.

For the standard bin, we recommend starting with one pound of worms, equal to about 1,000 of the little wigglers!

You can start with fewer worms, but the quantity of food you initially add to your bin will need to be decreased. Worms in your yard, garden, and compost pile may be red worms, but it's not likely. Just to be safe, get your red worms from a friend who already has a worm bin or purchase them from a local worm grower. (See www.ciwmb.ca.gov/Schools/Curriculum/Worms/ for a complete listing of worm suppliers.)

Place your worms on the bedding you have prepared and watch them burrow away from the light, down into the newspaper. They should "disappear" in 5 to 10 minutes. If you are building a bin with your class, this may be an interesting feature for your students to witness.

A healthy worm bin should be able to supply enough worms to get another bin started, but wait a few months before you attempt to share worms from your new bin. After you divide the worms, both bins will eventually reach an optimal population level. Red worms also have the amazing ability to control their population growth, which means you don't need to worry about a massive worm population



boom! Unless you have a major "tragedy," you probably won't need to replenish the amount of worms in your bin.

Feeding Feed Me!

Worms are not picky when it comes to food, as they eat many of the same items you do. They especially enjoy vegetable and fruit peelings, grains, coffee grounds and filters, newspaper, and anything else that is organic.

Although worms eat fruit, be sure not to overload your bin with a high citrus diet. For example, if you are making a large amount of freshly squeezed orange juice, all of the remaining orange peels can introduce a toxic amount of d-limonene, a chemical that occurs naturally in citrus and other plants, into your bin. D-limonene is released as the peels are torn and broken down. So, you wouldn't want to pulverize the peels before adding them to your bin, as this would create a high d-limonene concentration. Due to the slow decomposition rate of citrus peels, however, it is okay to add small to moderate amounts to an established bin. If you add citrus peels to your bin and it begins to smell like a moldy fruit stand, then you may want to save it for a future feeding.

Worms do not have teeth! They have a gizzard, similar to birds, that helps them grind small bits of food. Adding ground-up eggshells, oyster shell "flour," or a handful of gritty soil to your bin will help your worms with this process. Other organisms you will find in your bin, like springtails and mold, assist worms by breaking down the food waste first. Some foods take longer to break down because they are more fibrous, such as broccoli stocks, carrots, and potato peels. Some people like to puree their food waste first, thus allowing the worms to eat more quickly and process even more food. Worms in a standard bin can eat about a pound of food a day.

Contrary to popular belief, worms are not vegetarians. They will eat meat if you let them. However, we advise that you not add any meat, dairy, or oily foods because they form strong odors as they decompose, which attract undesirable visitors, such as mice and rats, to your bin. These critters may carry disease that you do not want to pass on to your garden or yourself! A word of caution: If allowed to, your worms will eventually clean meat bones so well that the bones' sharp edges would be a hazard to anyone burying food or harvesting castings from the bin (see "Harvesting" section).

Do not begin feeding your worms immediately after you introduce them to their new home. Give them a few days to a week to acclimate to the bin environment. At this point, their appetites will be in full force. In the meantime, reuse an old sour cream container or margarine tub to save your food waste for future feedings. (However, if you have asthma or allergies, feed the worms right away instead of storing food waste in a container, as mold spores will quickly result.)

Bury the food at least one inch deep to prevent odors and unwanted critters. Simply lift a bit of bedding, add the food, and put the bedding back into place. You can randomly pick spots to bury food, or set up a "quadrant" system. This system allows you to closely monitor the amount of food your worms are eating and also allows your students to practice fractions. Here's how it works:

Place the following in a worm bin:

- Shredded paper products
- Fruit and vegetable trimmings
- Grains, beans, or breads (without butter, margarine, or mayonnaise)
- Egg shells
- Fallen leaves
- Tea bags
- Coffee grounds and filters
- Lawn clippings and weeds



Quadrants

1	2
4	3

The first time you bury food, bury it in quadrant 1. The next time you feed, a day or two later, bury in quadrant 2. Your worms will follow the food. Continue this pattern until you are ready to bury in the first quadrant again. If there is still food in quadrant 1, you are feeding your worms too much or too often. Give them a few days to eat what is already there and then start the process again, feeding them less food or less often. If your worms have already eaten through the food placed in quadrant 3 when you are ready to feed in quadrant 1 again, you may want to feed them more food or more often.

Do not place the following in a worm bin:

- Meat products
- Dairy products
- Oily products



Your students can keep track of the feeding schedule by placing a laminated copy of your quadrant layout (like the diagram above) near the bin. Have your students use a nontoxic dry-erase marker to cross out each quadrant as they place food in it. You can also write the date of feeding for journal and record-keeping purposes. When all quadrants are crossed out, erase all of the markings and start over with quadrant 1.

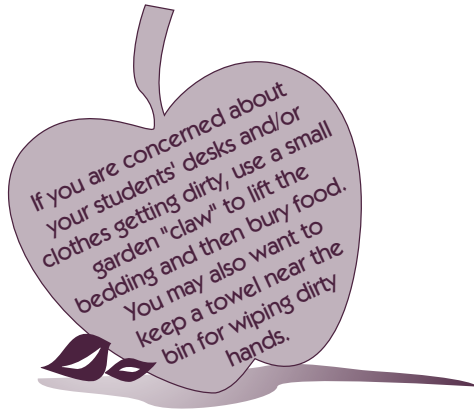

Harvesting Reap the Rewards

Your worms have been busy eating, and the contents of your bin are looking more like soil than shredded newspaper. You have compost! Since it is not necessary to harvest right away, you can plan a harvesting time that fits your schedule. The amount of time you need depends on the harvesting method you choose:

- **Cone Method:** If you don't mind getting your hands a little dirty, this is a great harvesting method for your students. Find a work area, preferably outside in a shady area, during a period of moderate temperatures, and lay down a tarp or large piece of plastic. Carefully empty the contents of your bin, worms and all, onto the work surface. Separate this pile into "cones" of about six inches in diameter. Give the worms a fair amount of time (about 10 minutes) to burrow down, away from the light. After they have done so, sift through the compost from each pile, a handful at a time, until all you have left

is a pile of worms. The harvested compost can be transferred to a separate storage container at this point, and your worms can return to their home with newly prepared bedding waiting for them.

- **Migrating Method:** This is a handy method for those who want to harvest fairly quickly, or not all at once. Open your bin and gently push the compost over to one side. Prepare new bedding and place it in the now empty half of the bin. From this point on, stop placing food in the compost side of the bin, and begin feeding in the new bedding area. Worms love your food waste, so it is the perfect bait for them to follow. Once most of your worms have made the journey over to their new bedding area, you can remove the compost. At this point, you will want to add more bedding to fill in the empty area of your bin. You can alternate your harvesting sides on a continual basis.

- **Scoop Method:** This is a perfect method for people who only need a small amount of compost at a time. Open your bin to allow light to penetrate the castings, thus gently forcing the worms to burrow away. Stirring the surface a bit will also encourage the worms to dive. After about 10 minutes, scoop off the top layer of castings. There should be few, if any, worms in the compost you have removed. If you still need more compost, continue to leave the lid off and wait another 10 minutes before scooping again.

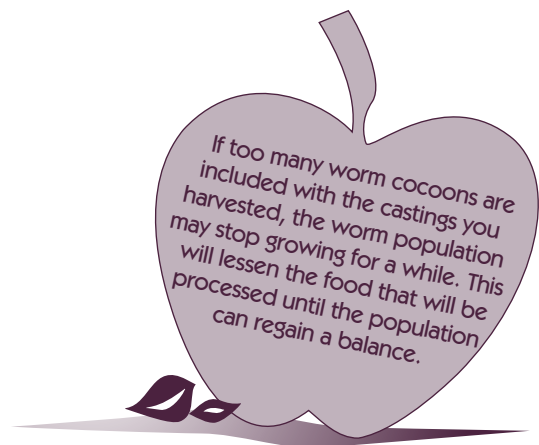

Warning: Vermicomposting is not an exact science. Although red worms are small creatures that need your tender loving care, a successful bin is really based on one thing—observation! There are many variables from bin to bin, so take the time to get to know how your bin works. There is not one right way to make and maintain a worm bin. Use your own judgment and common sense. The troubleshooting information in this section lists problems you may encounter and remedies you may want to try. If all else fails, worm counseling is available! Call the Office of Education and the Environment at (916) 341-6769 and ask for assistance from your county representative.

Troubleshooting

The Worm Doctor

Troubleshooting is based on experimentation, so getting to know your bin becomes very helpful when trying to remedy a problem. If a problem does occur and you think you've found a solution, don't stop there. Continue to give your bin daily check-ups until you see—or, in many cases, smell—an improvement. You may encounter some of the common problems listed below.

<u>Symptom</u>	<u>Diagnosis</u>	<u>Remedy</u>
Strong, Bad Smell	Not enough air circulation.	Fluff bedding. Make sure bedding or compost is not blocking the airholes.
	Too much food in bin.	Feed worms less food and/or less often.
	Improper food added.	Remove meat, dairy, and oily products.
	Food exposed.	Bury food completely.
Fruit Flies	Anaerobic conditions.	Add bedding to absorb moisture.
	Food exposed.	Bury food completely. Place bin outside in colder weather (temperature must not be below 50°F).
Ant Infestation	Too much food.	Don't overfeed worms.
		Place ant traps near, not in, your bin. Immerse bin feet in liquid. A barrier of chalk or petroleum jelly may repel the ants. If bedding seems dry, add water.
Mite Infestation	Mite population is high.	Avoid adding foods with high moisture content, such as fruits and vegetables.
Overly Moist	Too much water added to bedding.	Stop adding water. Add paper to soak up extra moisture.
	Too much food with high moisture content.	Put in less fruit and vegetable waste.

Be sure to keep in contact with your school grounds staff. Let them know you have a worm bin and request they notify you ahead of time of any pesticide spraying that may take place, whether it is in the classroom or outside. If spraying will be done for ants or other reasons, remove your bin from the premises to avoid worm fatalities.

Take your bin home during extended vacation periods, unless you plan to visit your classroom at least every few weeks for feeding purposes. You may want to have a parent or another teacher adopt the bin while you are gone.

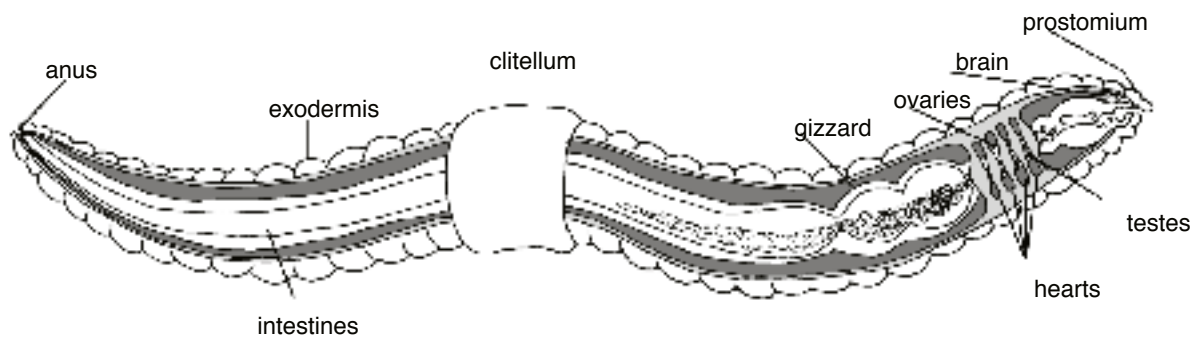

Biology

Annelid Anatomy

Annelids are segmented worms. The term “annelid” is derived from the phylum in which these creatures are classified—Annelida. This phylum includes marine worms, leeches, and earthworms, all of which possess the fundamental characteristic of soft, segmented bodies.

Anus

The end product can be found here. Worm castings are excreted through the anus, which is at the end of the intestine.

Intestine

A red worm’s intestine is a long tube that extends from the gizzard to the anus. Food passes through this tube by peristaltic muscle movement (progressive waves of contraction and relaxation).

Exodermis

Unlike humans, worms do not have lungs. Instead, they respire through the entire surface of their bodies, the exodermis. Oxygen dissolves in the moisture on the worm’s exodermis and then passes into their bloodstream. Worms need enough moisture to maintain their bodies’ moisture content, which is similar to that of humans at 75 to 90 percent. If you remove the worms from their bin for an activity, make it easy for them to survive the experience: place them on moist paper towels or newspaper and only keep them out of the bin for about 10 minutes.

Ovaries and Testes

Red worms are hermaphrodites, which means each worm is equipped with both female and male reproductive organs (ovaries and testes, respectively).

Clitellum

The clitellum is the light-colored band visible on the outside of a worm’s body. It plays a major role in the reproduction process of the red worm. Two worms join together so that each worm is in contact with the other’s clitellum. Each clitellum secretes mucus, through which sperm are exchanged and then enter the opposite worm’s sperm storage sac. After the worms separate from each other, the clitellum secretes another substance that hardens and forms a tiny, lemon-shaped egg case, or cocoon. As the worm separates from the cocoon, it deposits eggs from its own body along with its partner’s sperm from its sperm storage sac and fertilization then takes place inside the cocoon. Two or more baby worms will hatch from the cocoon after a few weeks, looking small and transparent. These baby worms will become sexually mature when their clitellum appears. Although worms are extremely prolific, their numbers will be regulated by environmental factors. Cold weather tends to slow reproduction, while an increase in food supply will often increase your worm supply.

Gizzard

A red worm’s muscular gizzard functions similarly to that of a bird. Small particles of sand and minerals lodge in the gizzard to aid in digestion. Muscular contractions compress the particles against each other and the food, mix it with enzymatic fluid, and grind the food into smaller particles. Undigested matter passes through the intestine as castings.

Hearts

Worms have five hearts that pump blood throughout the body. The blood carries digested food particles to whatever part of the worm's body needs them.

Brain

Red worms have a primitive brain—the size of a pinhead. This is where a cluster of nerves, which control the worm's actions, is located.

Prostomium

The prostomium is a small, sensitive pad of flesh that protrudes above a red worm's mouth. It stretches out to push soil particles out of the way as the worm moves along. When the prostomium finds a food particle, it pushes the food into the worm's mouth, where the peristaltic muscle action throughout the worm's body aids that food particle on its way to becoming a worm casting.

Other Worm Bin Residents

The Good, the Bad, and the Ugly

Ant

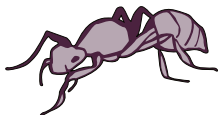

I am an insect with six legs. I am a decomposer because I break materials down into smaller particles. I create tunnels and move soil into clumps. Some people would rather not have me around their homes. I am black, brown, or red. Worms especially don't like me because I eat them.

Bacteria



I am so tiny that you can't even see me. I can eat almost anything. Some of us live together in groups and others of us don't.

Beetle



I am an insect with shiny, black, tough wings and am about 1/2 inch long. I am a predator and eat slugs, snails, and soft insects such as caterpillars. I live beneath stones, boards, and in other moist places.

Centipede



I move quickly on my many legs. I have 15 to 137 segments with a pair of legs on each. I am a fierce hunter and love to eat worms. I use my pair of poisonous claws to help keep my prey from getting away. I am about 1 to 2 inches long. I am usually reddish brown.

Collembola



I am a close relative of the springtail but can't jump like they do. I am tiny, less than 1/16 of an inch long. I eat molds and decaying matter. I am white in color.

Earthworm



I am a long, thin soft-bodied annelid that has many little segments. I do not have legs or eyes. I sense light and I breath through my skin. I eat bacteria, fungi, and decaying materials. I like dark, moist places.

Fruit Fly



I am a very small fly. When I fly around, I look heavy, as if weighted down by bricks. I don't bite, sting, make buzzing sounds, or harm worms. I tend to be brownish in color with black stripes on my abdomen, and usually have red or white eyes. Sometimes you will see me around a worm bin if a person forgot to bury my favorite food, fruit. I prefer to lay my eggs in fruit where it's moist and warm. I can lay thousands of eggs at a time.

Fungus Gnat



I am a small, dark gray or black fly. I fly around like a paper airplane. As a larva, I feed on soil fungi and plant roots and often hang out around houseplants. I can infect houseplants easily, so it is hard to get rid of me. Sometimes my friends and I will occupy a worm bin, but only in small numbers.

Mite



I am tiny. It would take 25 of us to cover an inch-long line. My body is round and fat, so it's hard to see my eight legs. I eat plant materials such as mold and soft tissues of leaves. Some of us eat the manure of other organisms. I am usually white, red, or brown.

Millipede



I have so many legs you would have a hard time counting them. My name means "thousand legs," but I don't have that many—only two legs per segment. I am very shy and I roll up in a ball to avoid danger. I am a vegetarian and eat soft, moist, decaying plants. I am dark red to black in color and am 1 to 3 inches long.

Mold



I am a fungus and related to mushrooms. In your bin, most of us live on old food.

Pill Bug or Roly Poly



I am an isopod, which means my pairs of legs look very similar to each other. I eat old leaves and other stuff like vegetable scraps. I am about a half inch long and I roll up in a ball if I am disturbed. Some people think I look like a little armadillo. I am a dark, greyish color.

Slug



I have muscular discs on my underside that are adapted for creeping and crawling. I lay egg masses that look like Jell-O. I eat living material but will make an appearance from time to time in your compost pile to eat fresh garbage and garden trimmings.

Snail

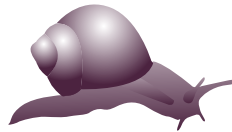

Like my friend the slug, I am a mollusk and creep around on my muscular belly. I, however, carry on my back a spirally curved shell. I also have a broad retractable hood and a distinct head. Like slugs, I prefer to eat living material, such as leaves, but I will also show up in your compost pile or worm bin.

Soldier Fly



I am usually black and look like a large wasp-like fly. I always breed in organic material that is damp and usually in an advanced stage of decomposition. I hang out around dumpsters, garbage receptacles, and compost piles to lay my eggs.

Soldier Fly Larva



I have a flattened body. Generally, I range in color from dark brown to cream. I move fast from one place to another because I wiggle around aggressively. Since my appetite is huge, I can eat massive amounts of organic material. I don't eat worms, though. You can find me around dumpsters, garbage receptacles, and compost piles.

Sow Bug



My pairs of legs look alike, and that makes me an isopod like my cousin Roly Poly. I eat vegetation and old leaves. My half-inch-long body is oval and flat with flattened plates, but I can't roll up into a ball like Roly Poly. I am related to crayfish and lobsters. I breathe with gills, so I must live in a damp, moist place. I am a dark, greyish color.

Spider



I am related to mites and have eight nifty legs. I am one of the least appreciated animals in the garden and compost. I feed on other insects and work hard to help control pests that will hurt a garden.

Springtail



I am a tiny insect less than one-sixteenth of an inch long. I eat molds and decaying materials. I have a little spring that helps me jump high into the air. I am white.

White Worm



I look like a frayed piece of thread. I am a skinny, white worm, about an inch long. I like to eat rotting food after the other critters get to it. You might think of me as one who likes to finish off the job.

Text adapted from ***Do the Rot Thing: A Teacher's Guide to Compost Activities***, Alameda County Waste Management Authority and Alameda County Source Reduction and Recycling Board, San Leandro, CA, 1997. Used with permission.

The Garden Connection

A garden can be a food source, an outdoor classroom, a place of rest, a habitat for endemic flora, or all of the above. Whether you grow flowers, herbs, vegetables, or a little bit of everything, gardens are a place for learning. They are perfect for getting your hands dirty and your mind engaged in exploring the world that surrounds you.

Learning by doing often allows students to succeed academically, because they can touch and see the concepts they are being taught. Hands-on activities are engaging and fun for everyone. It is exciting when students who are normally quiet or have difficulty learning in a formal setting take an active role and show leadership qualities. With a school garden, students learn to nurture, wait patiently, become responsible for part of a project, and claim ownership for their success. Being involved in these activities helps create self-esteem and pride for both individual and team accomplishments.

A school garden is an outdoor classroom. Basic science and mathematical concepts are automatically associated with gardens, but other concepts are explored as well, such as nutrition and agriculture. Nutrition education plays a large part in garden learning and, ultimately, in the health of the students. Some of the most finicky eaters, students who were once completely opposed to eating certain fruits or vegetables, discover that their garden harvest is quite tasty! For some students, a school garden provides the opportunity to eat fruits and vegetables they have never tried before. A school garden, on a small scale, demonstrates how the agricultural sector of California, and the world, ties into our daily lives. Students can discover with their own eyes and hands what makes a seed grow, what is needed to prepare soil, how to maintain a healthy crop, how to harvest crops, and what it takes to get food from a farm to our tables.

Other topics, such as economics, cultural diversity, language arts, music, and art are often overlooked but are wonderful avenues to tie into lesson plans. Instruments used for rhythm can be made by putting seeds in a sealed container. Language art lovers can write to their heart's content through poetry or creative writing about the garden. Endless art pieces can be inspired by a garden, whether it is a flower petal mosaic or a painting of a favorite flower. Once students get hooked, it's hard to stop them! School gardens are an endless source of learning and fun.

Closing the Food Loop at Your School

If you have a school garden, a vermicomposting system is likely to follow. Fruit and vegetable waste from the garden or cafeteria are a valuable resource for your school. These materials can be cycled back to the garden as compost through vermicomposting, instead of being wasted and sent to the landfill. In addition to the integrated waste management hierarchy, your school can also utilize the food waste hierarchy.

Food Waste Hierarchy

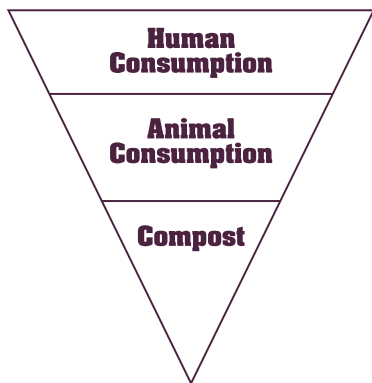

There are several methods schools can use to “reduce” food waste. One such method is “offer vs. serve.” This option empowers students to reduce the amount of waste they create by allowing them to select which food items they prefer, rather than being served something they may not want. Food items that are slightly stale, irregular, or past the due date are often thrown away. Wait! This food can be donated to a local food bank to provide meals to people in your community. Food items that are very old and not suitable for human consumption may be useful as animal feed for a local farmer. With these kinds of partnerships, everyone wins. Your school reduces disposal costs, people are fed, the farmer has free animal feed, landfill space is saved, and natural resources are cycled for reuse.

If there are large amounts of food waste from the school, ask your local public works department if services are available that allow you to have the food waste composted at a local composting facility. This process cycles the decomposing materials back to the earth. You can also save energy and gas by keeping the food waste at your school and composting it yourself. School staff and/or students may be willing to maintain a compost pile or large-scale vermicomposting bin.

School Food Cycle



How to Get Started

Be assured there is no one way of setting up a food diversion program at your school, but there are a few key ideas to keep in mind as you get started.

1. First and foremost, obtain the full support of your administrators before doing anything. They can help to institutionalize the program as a normal function of the school rather than a pet project that will likely fail once the key facilitator leaves the school or is no longer involved.

2. Next, develop a plan. Writing out objectives ensures that the project stays on target. Objectives outline the purpose of the project and spell out the roles of each individual. It is a good idea to include food service and custodial staff in the planning process to foster program ownership. Start out small to ensure a solid foundation for your program, and then build on your successes.

3. Once you have established your program goals, start developing the basic structure of the program. A collection system to separate the food is first on the agenda. Determine how much food you want to collect to feed the worms. Ask the key players for their thoughts on possible problems they foresee. Take the time now to work out the issues before they become problems! All involved will have different and valuable insights based on their own perspectives gained from working on different parts of the program.

4. Build a large enough vermicomposting system (or outdoor compost bin) to accommodate the amount of food waste determined necessary for the program.

5. Clearly mark containers “Garbage” and “Compost” so it is easy for students to separate their food. Before the initial start date, it would be helpful to go through the collection process as if you were a student yourself so you can make adjustments as necessary.

6. Before implementing the program, review the information in this guide and plan to present key points to the faculty, staff, and students. This outreach is critical, as it will teach the whole school what can be collected as compost and what must be thrown away. Keep this review simple and repeat it several times before the start date of the program, reminding everyone what is happening and what their roles are.

Many programs throughout the state have trained students to become “worm experts” who then help make the program successful. They are responsible for teaching other students, ensuring that food is properly separated at the bins to minimize contamination, and then placing the food in the worm bin. Their role lightens the load for custodial and food service staff. Whether staff or students place food waste in bins, be sure they do this soon after collection, rather than store the food waste in a container for a few days.

You will need to make adjustments along the way, so be flexible. Keep the program simple and build on your successes!

Fundraising

Making Money Worm-Style

Here are a few ideas for raising money for your program.

- Package and sell worm castings to parents and community gardeners.
- Establish a partnership with a local bait shop to sell red worms.
- Grow plants with worm casting-enriched soil and host a plant sale.
- Create a worm starter kit, which could include worm bedding, red worms, and an instructional packet on how to get started. Sell the kits at Open House, Back-to-School Night, a science fair, or a PTA event.
- Make planter containers out of recycled paper to sell at your plant sale. Instructions for this project are included in the “Making Recycled Paper by Hand” lesson in the CIWMB curriculum, **Closing the Loop**—call (916) 341-6769 to request a copy.
- Make a calendar or poster to promote your school garden and recycling efforts to reduce food waste. You can include some of the worm facts found in this guide (use nontoxic markers.) Sell the calendars or posters at Open House or Back-to-School Night.
- Host a puppet show! Make worm puppets by stuffing pantyhose with cotton balls or dryer lint and reusing other items to embellish the puppets’ worm features. Collect donations to view the puppet show at Family Night.
- Facilitate a student-run vermicomposting mini-workshop to promote food waste reduction in your community. The students can build the bins on site and sell them at the workshop.
- Wood shop classes can make wooden worm bins to sell to interested members of the community or donate to your school’s program.
- Have students approach businesses and local organizations that may offer community assistance in the form of funding and/or resources for your school’s vermicomposting program. Students should be prepared to share program goals, projected outcomes, how the company will benefit from contributing to the program, and what is needed in order to accomplish program goals. Some possible businesses or organizations to contact are:
 - Local hardware, lumber, and nursery stores.
 - Local chapter of the Association of Nurserymen.
 - Certified master gardeners.
 - Kiwanis, Rotary, and other service organizations.
 - PTA and booster clubs.
 - Conservation corps.
 - Recycling, composting, and waste hauling companies.

Activities for the Classroom

My Worm Biography!

Name _____

Create your own worm biography by completing the sentences below.

My worm's name is _____

My worm is _____ inches long.

My worm feels like _____

My worm moves around by _____

My worm likes to _____

My worm likes to eat _____

I do not feed my worm _____

My worm helps the soil by _____

My worm likes to live in _____

If my worm could talk, it would say _____

If my worm were a superhero, it would _____

If my worm had a superhero buddy, its name would be _____

and it would _____

_____ the Worm
(name)

Name _____

Fill in the blanks with the appropriate type of word to create a silly story!

It was feeding time at the worm bin, and not a(n) _____ too soon.
(measurement of time)

_____ the worm was getting awfully _____. "I wonder what kind
(worm name) (adjective)

of _____ I will be _____ today," _____ the worm
(noun) (verb ending in "ing") (worm name)

thought. "It better be _____. Yesterday, all I got to _____ was
(adjective) (verb)

a _____, and that was really _____. "The lid to the bin opened,
(noun) (adjective)

and _____ saw that familiar _____. It was the same _____
(worm name) (body part) (same body part)

that came every feeding day. _____ the worm waited with _____. "
(worm name) (feeling or emotion)

_____!" _____ the worm shouted. "It's a _____!"
(exclamation) (worm name) (noun)

This will keep me very _____ until next feeding time." With that, _____
(adjective) (worm name)

the worm went to bed with a very _____ tummy.
(adjective)

My Worm Story and Picture Book

Name _____

Fill in the blanks to create Wally's story. Then, draw pictures to show what he has done. To make your book, cut along the dotted line and staple the half-sheets together.

Wally the worm went for a squirm...

up the _____ /



around the _____ /

and into the _____.

Along the way, Wally bumped into Sammy the Spider, his best friend,
and they decided to go towards the _____

and into the _____ /

.....

over the _____ /

across the _____,

.....

and back to the _____.

Activities by Subject

The following are “starting points” grouped by subject matter that you may wish to use in developing a lesson correlated to your worm bin.

Art

- Illustrate your worm story.
- Make a poster of “Good and Bad Worm Food Items” to display near your bin.

English/Language Arts

- Write a story or poem about a worm.
- Keep a worm bin journal. You can make the journal out of paper that has already been used on one side.

Math

- Teach fractions with the quadrant feeding system.
- Determine the water-to-bedding ratio.
- Calculate how much food waste you divert from your classroom/cafeteria by using your worm bin.
- Teach extrapolation by conducting a population count of one quadrant and then figuring the bin’s entire population.

Music

- Write lyrics, create a dance routine, or create hand motions to a song about natural resources and/or vermicomposting. Have the class perform at Open House to teach students and parents what they learned.
- Explore other cultures. How are rain sticks made and what is their purpose?

Nutrition

- Determine how much energy can be produced by eating certain quantities of food.
- Learn about vitamins and minerals stored in fruits and vegetables.

Science

- Observe worm anatomy under a dissecting microscope.
- Use vermicompost to grow plants. Compare the growth rate of plants by using varying levels of casting mixtures.
- Discuss the soil cycle.
- Discuss decomposers and scavengers.
- Have students research worm secretions and find information on their medical uses for burn patients.
- Make a poster of the life cycle of a seed or a worm.

Social Studies/History

- Research the history of waste management in California or the world.
- Research the history of America’s farmland topsoil and how this has affected California’s agriculture and economy.
- Research how **reduce, reuse, and recycle** concepts and practices have become more socially acceptable.

Service Learning

- Research how a local restaurant or cafeteria in your community disposes of its food waste. Help the owner or manager devise a plan to divert that waste from the landfill and put the plan into action!



The Adventures of
VERMI
the
WORM

The Adventures of Vermi the Worm!

We have a new way for your students to learn about vermicomposting!

Would you like to energize your lesson plan? Would your students get excited about learning if they got to use the computer? If you answered “Yes!” to either of these questions, then we have the teaching tool you’ve been looking for. It’s an animated, interactive Web site-The Adventures of Vermi the Worm!-that teaches the basics of vermicomposting and its benefits, as well as the “3R’s” of waste management—Reduce, Reuse, and Recycle!

Your students will go on an adventure with Vermi the Worm as he visits a school garden and hooks up with his buddies, Bubba the Worm, Hugh Hammer, Sunny Flower, and Trashcan. At each stop, students will view something about vermicomposting or the 3R’s and have the chance to participate interactively by helping their new buddies. At the worm bin, they’ll help regulate a worm’s habitat; at the garden, they’ll do an experiment using vermicompost; with Trashcan, they’ll make choices on how to reduce, reuse, recycle, and vermicompost-thus saving items from ending up in the garbage. And there’s much more!

This activity can be used in conjunction with classroom lessons, as part of school gardening activities, or as a self-contained, computer-based experience for your students. Use it with small groups or let students encounter it individually. “The Adventures of Vermi the Worm!” would make great use of computer lab time for your students.

These activities are correlated to the State content standards. Correlations can be found on the teacher’s page located within the site. Though the site was designed at the 3rd grade level, you may find it applicable for younger and older students. So, give it a try and then share it with your students!

System requirements for using the Vermi the Worm Web site (approximate size, 9 MB):

- Microsoft Internet Explorer with Flash 5 plug-in.
- Pentium 166 with 64 MB of RAM minimum, Pentium II with 128 MB of RAM preferred.
- Any PowerPC Macintosh with 64 MB of RAM.
- Windows 95 or MacOS 8.5 minimum operating system minimum, Windows 2000 or MacOS 9.1 preferred.
- 56K modem minimum connection speed, ISDN, DSL, T1 or cable modem preferred.

Website address: www.ciwmb.ca.gov/Vermi/.

Case Studies

Davis Joint Unified School District Food Waste Diversion Project

Submitted by Cynthia M. Havstad
UC Davis School Gardens Project
Davis, California

On an average day in Davis, California, each elementary school in the Davis Joint Unified School District (DJUSD) generates approximately 140 pounds of waste from student lunches. This is enough for every school to fill two-thirds of a dumpster with trash from lunch each school day, 176 days of the year. The items that take up the most room in the trash can are the 200 to 300 disposable trays on which hot lunch is served. The cost the DJUSD pays for disposing of these trays is more than \$1,300 per school—much higher than the three-cents-per-tray purchase price!

Slightly more than 100 pounds of the daily lunch waste is food. On a yearly basis, that adds up to 9.2 tons per school, about as much as would fill nine dumpsters at each of the eight elementary schools in Davis. What's more, almost one-fourth of all the "trash" thrown away every day is edible food—unopened packaged hot-lunch items such as burritos and bags of carrots, full cartons of milk, and untouched apples.

Compostable food waste is also generated every lunch period—about 15 pounds from each school. This food waste can be fed to worms or put in a compost pile, thus reducing the waste stream, cutting disposal costs, and providing students with hands-on learning activities that can be used to meet State standards.

Understanding the tremendous educational potential for students, the Davis Farm to School Connection thus established a pilot project (DJUSD Food Waste Diversion Project), funded by the California

Integrated Waste Management Board, to develop and test site-specific systems reducing lunch waste at three elementary schools (Birch Lane Elementary, Cesar Chavez Elementary, and Pioneer Elementary Schools). The Davis Farm to School Connection (a project of the Davis Educational Foundation) is a coalition of district staff, parents, and community members with a vision to educate and nourish students through a farm- and garden-based experience. The coalition has raised funds to integrate school garden-based educational activities with opportunities for students to eat from locally supplied salad bars, compost lunch food waste, visit local farms, and cook in the classroom—all with the goals of increasing enthusiasm for learning, improving eating habits, and guiding students to become mindful caretakers of their community and the environment.

The DJUSD Food Waste Diversion Project included vermicomposting, composting, food rescue efforts, and a switch to an offer-vs.-serve food service plan. At all schools in Davis, including the three sites for this project, the DJUSD nutrition service director implemented a lunch program that offered students choices of hot lunch items. Providing students with a choice at lunch can reduce the waste stream. Also, at all three project sites, the organic wastes generated from student lunches and school gardens were composted or vermicomposted. The methods of composting included a mid-scale composting system with an enzyme pretreatment, mid-scale composting and vermicomposting systems without pretreatment, and a classroom-scale vermicomposting system. Rescue of edible, unopened food was included in the project at two of the three sites, Cesar Chavez and Pioneer Elementary Schools. To further reduce the lunch waste stream, molded fiber trays replaced the polystyrene ("Styrofoam") trays previously used for hot lunches at Cesar Chavez and Pioneer Elementary Schools.

Unique to Pioneer Elementary School was the introduction of a salad bar. The salad bar, which is called the “Crunch Lunch,” was offered as an alternative to the hot lunch. Students are given the choice between the hot lunch and a salad with fresh, locally grown fruits and vegetables. Davis Farm to School Connection wants to introduce this concept, along with gardens and recycling projects, to every school in Davis.

At Pioneer, the salad bar was tremendously popular: an average of 179 students, with as many as 300, chose a salad every day it was offered. The number of hot lunches served declined from an average of 235 the previous year to 114 after the Crunch Lunch was available. Remarkably, the food waste portion of the lunch waste stream at Pioneer decreased in volume by more than one-third after introduction of the salad bar. Even more dramatically, the edible food being thrown away decreased by more than 60 percent—34 pounds of unopened packaged food and whole fruits were thrown away daily before the Crunch Lunch was available; only 14 pounds per day, after its introduction. Students clearly throw away less food when they are given the choice of a salad for lunch.

Each of the three school sites was able to successfully divert food waste and implement effective composting systems for handling that waste. Two of the three schools significantly reduced the total school waste stream, achieving 47 percent and 50 percent reductions by the end of the pilot year and saving the district \$6,230 in disposal fees alone. This does not include savings generated by decreasing the time the custodian spends handling lunch waste or reducing the trash bags and cans used. And, because the reductions were phased in over the course of the school year, it is projected

that continuing the project for the 2001-2002 school year at the same three sites could save the district \$13,675 in disposal fees. That is equivalent to an approximate savings of \$6.60 per student. Multiplied across the school district, the savings would be even more significant!

Lessons and Recommendations

The three pilot sites demonstrated different strengths in one or more components of the project: reducing waste, integrating the project into the curriculum, or bringing information about lunch waste diversion to the community. Some of the lessons that were revealed from each school program, and the recommendations that follow from them, are:

1. It cannot be assumed that the school district will recognize the value of modeling integrated waste management practices and thus giving students the opportunity to practice solutions to the environmental problems they are learning about in their classes, even when such solutions decrease waste hauling costs. It is therefore very important that any waste reduction projects first identify and cultivate the support of the school board and district superintendent as early in the process as possible.
2. The site coordinator is more than an addition to the custodial staff, as that person's responsibilities include creating a site team, evaluating and reducing the waste stream, and facilitating integration of the program into the curriculum. Paying that person for the 1.5 hours per day required to fulfill those responsibilities is critical.
3. Implementing, managing, and integrating a lunch waste diversion project into the school curricula involves much work and should utilize a team that includes the site coordinator, teachers, staff, students, and parents. Students are valuable members of the team, which then makes the project an excellent educational opportunity. The high school service/learning program could also be a valuable partner to a lunch waste diversion project, providing high school students to site teams while offering them an opportunity to meet service-learning requirements.

4. Having a memorandum of understanding signed by principals, site coordinators, and district staff would clarify everyone's roles and commitments.

5. Audits are critical to designing appropriate composting or vermicomposting systems, keeping the project within budget, and preventing composting problems.

6. Disposable trays make up the largest portion of the lunch waste stream. It can cost as much or more to throw them away as to purchase them. Substituting recyclable or compostable trays is thus very important in reducing waste disposal costs. "Carry out" trays are a lightweight cardboard and are recyclable in Davis, even when contaminated with some food waste. The district purchased these trays with a child nutrition message on them from Sysco at \$13.10 per case of 500.

7. Edible food is also a significant portion of the lunch waste, on a per-weight basis. Policies on food sharing and returning unopened food to the district's food services or donating it to off-site sources must be developed. Distributing information on the Good Samaritan Act* would facilitate this process.

8. There are often others who are using the school's waste containers. Identifying those who have access to the dumpster and encouraging their participation or preventing their access to the containers is important.

9. Salad bars do not generate additional lunch waste, though they do change the nature of the waste stream. More compostable food is generated, but significantly less edible food is thrown away.

*The Emerson Good Samaritan Food Donation Act is legislation providing protection to citizens, businesses, and nonprofit organizations that donate, recover, and distribute excess food in good faith (42 United States Code, section 1791).

The Future of Lunch Waste Diversion in the Davis Joint Unified School District

Eight additional elementary and junior high schools in Davis have indicated interest in composting or vermicomposting lunch waste next year. To support start-up at new school sites, funding commitments to purchase sorting stations for each school (\$300 value each) and for photocopy costs for parent outreach (\$300 per school) have been made by Davis Waste Removal and the City of Davis. Responding to the interest while also "growing" the program at a moderate rate, the Davis Farm to School Connection proposed that the program be continued at Birch Lane, Cesar Chavez, and Pioneer, and that it be started at three additional schools next year. If each school reduces its waste stream by 40 percent, as demonstrated the first year, the total projected savings of \$32,490 would more than cover the cost of the program.

Although the DJUSD has determined it is not willing to financially support any lunch waste diversion efforts, there is sufficient interest and dedication on the part of parents, teachers, and staff to continue diverting food from the lunch waste stream at the current and new sites without funding from the school district. Such a program will focus on composting or vermicomposting food waste and the associated educational opportunities for students, modeling environmentally sound practices for our students, and integrating the composting program into our school garden program, as part of the vision of the Davis Farm to School Connection. Reducing the lunch waste volume or reducing the disposal costs for the district will not be stated as goals. The Davis Farm to School Connection will continue to encourage the district superintendent and school board to support a district-wide lunch waste diversion program, based on the success of and knowledge gained from the pilot project.

For more information on the Davis Joint Unified School District Food Waste Diversion Project, please contact Cynthia Havstad at cmhavstad@ucdavis.edu.

The following article about Pioneer Elementary School's lunch salad bar, "Crunch lunch' in Davis," appeared in The Sacramento Bee April 13, 2001. Text and photographs used with permission. Photographs by Jay Mather.

"Crunch lunch" in Davis

A buffet of locally grown produce offers a fresh alternative to much-maligned school cafeteria fare.

By Pamela Martineau, Bee Staff Writer

Plastic-wrapped, microwaveable slabs of pizza sat unopened and uneaten at the hot-lunch table at Pioneer Elementary School in Davis on Thursday as kids lined up to buy the school's new, organic "crunch lunch."

A buffet of vegetables and fruits grown on local farms, Pioneer's new "crunch lunch" program offers kids an organic alternative to the much-maligned school lunch fare that has been eaten by children for decades.

"That's really old," Matthew Heard, 10, said of the pizza being offered across the room. "This is brand new."

Alyssa Gutierrez, 10, said she thought the "crunch lunch" salad bar was "great." For \$1.75, the same price as the traditional school lunch, she was able to eat a lot of her favorite fruits.

The new lunch program is envisioned by organizers as a way to offer children healthier food while teaching them about agriculture and nutrition.

Funded through grants from the California Department of Education and the U.S. Department of Agriculture, as well as private donation, the program also supports local farms by using their produce in schools.

"The farmers market salad bar at Pioneer builds on our vision of a garden in every school where the kids are growing

healthy food and have a chance to see some of the same seasonal fresh foods grown by local farmers at their school lunch counter." said Delaine Eastin, state superintendent of public instruction.



Many students bypass the traditional hot-lunch line for the salad bar. "This is brand new," says Matthew Heard, 10.

At Pioneer, children work in the school gardens learning which fruits and vegetables are in season and what they need to grow. But only a few of the vegetables in the school garden make it into the salad bar. Most of the salad bar fare is from local farms.

Jamie Buffington, director of the Pioneer school garden program, also works with the children to encourage composting and recycling. And the children visit local farms on field trips.



Volunteer Mary Lust helps second-graders Jamon Turner, 7, left, Nasa Okamoto, 7, and Michelle Hansen, 8, select lettuce leaves for Thursday's salad bar. As part of Pioneer Elementary School's new "crunch lunch" program, kids are growing a small organic garden.

Pioneer is the first Davis school to open an organic salad bar. Organizers hope to open another next month at Cesar Chavez Elementary School. Eventually, they hope to have an organic salad bar in every Davis school.

Teaching good nutrition is key to the Farm to School program. Renata Brillinger, who coordinates the program for the Davis Joint School District, said an adult will be on hand at each salad bar as the children load up their plates, making sure they get enough protein and a healthy mix of food. Each salad bar offers a complete meal of six to eight seasonal vegetables or fruits and two or three protein-rich food such as eggs, tuna fish, beans and turkey.

The Farm to School program is part of the California Department of Education's push to teach healthier eating habits to children in an effort to cut down on the childhood obesity that is plaguing the nation.

A nutrition specialist at the University of California at Davis is evaluating the salad bar program for the state Department of Education. The School to Farm program is modeled after similar ventures in Santa Monica and Berkeley.

Copyright, The Sacramento Bee, 2004

Making a Difference: One Piece of Paper at a Time

(Jiminy Cricket's Environmental Challenge—2000–2001 Grand Prize Project)

Submitted by Deni Lopez
Park View Center School
Simi Valley, California

School Description: Park View Center School is a K–6 school serving 630 students. Approximately one-third of the student body consists of second-language learners; the class has two non-English-speaking (Spanish-speaking) students. The school has 32 special education students who participate in the school. Park View is a Title 1 school (low-income) serving a large population of at-risk students and their families.

Project Title: Making a Difference: One Piece of Paper at a Time

Project Goal: Reduce trash the school sends to the landfill and educate the school and community on how to recycle and reduce.

Project Description

- Reconstructed existing school worm farm that had been abandoned (when the teacher who built it went to another school) and later vandalized.
- Worms now consume 30 pounds of cafeteria food every day.
- Produced 96 cubic feet of vermicompost (as of March, 2001).
- Recharged and expanded school recycling program.
- Recycled school food waste from cafeteria to feed the worms.
- Reduced the amount of food going to the landfill daily by 50 percent (from between 60 and 90 pounds to between 30 and 45 pounds).

- Recycled school paper, plastic, glass, and metal to raise money.
 - Established permanent recycling area.
 - Conducted recycling drives.
 - Created a papermaking factory in the classroom.
 - Used school recycled paper to create new paper for art projects and to produce items for sale.
 - Built dehydrator to use in papermaking process.
 - Revitalized school garden soil by incorporating vermicompost.
 - Educated others on how to recycle school waste, why it is important to recycle, how to care for worms, problems facing the Simi Valley Landfill, and how to make paper.
 - Held a Worm and Recycling Education assembly for the entire school.
 - Provided mini worm farms for each classroom (27).
 - Conducted classroom presentations on recycling and papermaking.
 - Developed educational posters to hang at school.
 - Developed a “Sorting Paper Game Board.”
 - Participated in districtwide Math-Science Olympiad Day (sponsored by district math mentors).
 - Had an educational booth at local Farm Fest (April 28, 2001).
 - Wrote to other schools in district offering to teach them how to implement recycling/composting programs.
 - Six other teachers in district now have vermicomposting programs.

- Fundraising.
- Sold worms.
- Sold vermicompost.
- Sold mini worm farms nationally.
- Wrote, produced, and sold mini worm farm instruction book.
- Sold homemade paper products (journals, scented squares, greeting cards, art projects).
- Held recycling drive.
- Funds raised were donated to aid India earthquake victims (\$650) and used to purchase new recycling bins for 25 classes.
- Sold mini worm farms at local Farm Fest (April 28, 2001).

Curriculum Connections

This project was tied to the California content standards, particularly in language arts and mathematics. It covered requirements for reading, writing, written and oral language, listening and speaking, number sense, algebra, geometry, statistics and data, and math reasoning. Of particular interest:

- The amount of items in regular trash that could have been recycled was tracked, by grade level. That number was then equated to kilowatts of electricity wasted, gallons of water wasted, numbers of trees wasted, and unearned money. Recycling rates were evaluated before and after the Worm and Recycling Education assembly; recycling rates increased.
- Language arts skills were developed through recycling and worm care research, letterwriting, developing oral presentations and lessons, and expository writing.

- On the Stanford 9 Test, this class made dramatic gains of 9 to 15 percent over the previous year's scores in the areas of reading, math, and language. More specifically, 5 out of 29 students scored "Advanced" on California's content standards and 10 out of 29 scored "Proficient." This means over 50 percent of the class was proficient on the content standards. By contrast, only 20 percent of the new students at Park View Center School and 30 percent of the students in the entire State of California scored "Proficient."

For more information on the Making a Difference project, please contact Deni Lopez at (805) 520-6758.

Garden of Learning

Submitted by Kelli Wessman
Louisiana Schnell Elementary School
Placerville, California

The garden at Louisiana Schnell Elementary School started in much the same way as other school gardens. Teachers and administrators, enthused by the potential of a garden as an outdoor classroom, rounded up parent volunteers and a small amount of funding, resulting in a garden as a part of the school landscape.

The Schnell School Garden

Once the garden was built, the key players worked out the logistics of providing access for 20 classes every week of the school year. It was a daunting task. The school's 450 students were organized into small groups so they could efficiently and effectively carry out their garden activities. The groups are led by teachers and volunteer "garden parents" from each classroom. These parent volunteers receive ongoing instruction and training to ensure the program's sustainability. They work

closely with teachers and with a school garden coordinator, and/or a committee of coordinators. In the garden, students participate in weekly activity plans covering a variety of subjects.

The activity plans not only educate students, but also provide opportunities to do work in a garden or perform garden-related activities. Activity plans may call for a student to work necessary fertilizers into the soil or use a soil-test kit to learn about pH. Many of the mid-winter activities have indoor components.

Students do all of the hands-on work in the garden under parent and teacher supervision. In the summer, the garden goes essentially unattended. It is mulched heavily to prevent weeds, watered by an automatic sprinkler system, and then cleaned up when students return to a new school year in August. Then they harvest the autumn crop (planted during the previous spring) and prepare for planting the winter crops. The students continue to nurture the garden throughout the school year.

Students use organic gardening techniques to raise vegetables, flowers, and herbs. They tend the garden, tilling and weeding it. Ultimately, they eat part of what they produce, and sell the remainder at their own "farmer's market" during the spring to help sustain the program.

The garden program also provides a tremendous spectrum of experience-based learning that includes composting and vermicomposting activities. Students build compost piles, observing and comparing the rate of decomposition for various materials. This activity teaches them about scientific observation skills and the obstacles society faces with waste management.

Vermicomposting is a large part of the garden program. It is implemented throughout the year because it is so popular with the students.

At the beginning of every school year, students “rebuild” the contents of their huge “Worm Motel.” Then for the remainder of the year students recycle lunch and garden scraps to feed the worms. The school’s lunch staff supervises and monitors the students as they separate out compostable materials from the food and garden waste. In the middle of winter, students “check out” worms from the Worm Motel. They enjoy examining and studying the worms, learning about their physical anatomy and about their role in enriching the soil. At the end of the school year, before students replant the garden to which they will return in autumn, they remove castings from the Worm Motel and dig them into the garden plots to enrich the soil.

Activities with worms and composting are only a fraction of what is done in the Garden of Learning program. Teachers integrate weekly garden activities with classroom studies. The garden is used to enhance skills in reading, writing, math, nutrition, social studies, science, and fine arts.

Connecting the Garden to Classroom Instruction

As the very foundation of this school garden program is the Garden of Learning, a curriculum and organizational system for running elementary school garden programs. The Garden of Learning program was developed by Kelli Wessman, Schnell School’s garden coordinator, and has evolved since 1990. More than a dozen California schools use the Garden of Learning program, with Kelli as a consultant. The program’s mission is to establish garden programs that teach a wide variety of subjects and can be sustained over many years at minimal cost, by careful organizing and making good use of parent and community volunteers.

Garden of Learning is an example of how, by integrating real-life, hands-on activities that are closely linked to classroom curriculum, students come away with rich and meaningful experiences. A well-structured garden program benefits children in many ways:

1. Fosters a sense of ownership and pride in their school.
2. Provides a focus for learning that engages all of a child’s learning styles.
3. Develops a true cooperative spirit as children work together toward a common goal.
4. Provides a respite from the busy school life by allowing children to focus on a task in a smaller, quieter setting.
5. Provides for children an understanding of what nurturing means—in the process of protecting and nurturing plants, they are themselves nurtured.

Garden of Learning programs don’t require a large cash outlay. They typically receive financial support from discretionary funds available to school site councils and from parent clubs. Community service clubs, local farm associations, and other local groups often make cash contributions. Garden expenses are managed through partnerships with local nurseries and hardware stores, which supply materials and tools. Garden fundraising events generate both financial help and community excitement. The largest fundraising event tends to be an annual farmer’s market, usually held in the spring and during Open House.

For information on Garden of Learning, contact: Kelli Wessman / 2400 Wild Goose Canyon Road / Placerville, CA 95667 / (530) 626-1083.

Appendix A

... Educational Materials

- **Closing the Loop: Exploring Integrated Waste Management and Resource Conservation**, California Integrated Waste Management Board, Sacramento California.
(916) 341-6769
www.ciwmb.ca.gov/Schools/
- **Do the Rot Thing: A Teacher's Guide to Compost Activities**, Alameda County Waste Management Authority and Alameda County Source Reduction and Recycling Board, San Leandro, California.
(510) 635-6275
www.stopwaste.org/edresources.html
- **Composting Across the Curriculum**, Marin County Office of Waste Management, San Rafael, California.
(415) 499-6647
- **Creepy Crawlies for Curious Kids**, Lynn Ransford, Teacher Created Materials, Inc., Sunset Beach, California.
www.buyteachercreated.com/estore/product/0217
- **"Getting Hooked on Worms" in Grow Lab: Activities for Growing Minds**, pp. 214–221, National Gardening Association, 180 Flynn Avenue, Burlington, Vermont 05401.
- **The Wonderful World of Wigglers, A Common Roots Guidebook**, Julia Hand. Food Works, Montpelier, Vermont.
- **Worms Eat Our Garbage**, Mary Appelhof, Mary Frances Fenton, Barbara Loss Harris. Flower Press, Kalamazoo, Michigan.

Appendix B

... Web Sources

- **Vermicomposting**
- **The Worm Woman**
Mary Appelhof's site for worm composting offers a list of helpful resources and equipment for both home and classroom worm bins.
www.wormwoman.com
- **Worms!**
The California Integrated Waste Management Board addresses the recovery of organic resources. Teachers and students can learn the role of vermicomposting and find a list of worm and worm bin suppliers by county.
www.ciwmb.ca.gov/Organics/Worms/
- **Composting**
- **Composting for Home Gardens**
You will find helpful definitions of composting terms and examples of different types of available bins, provided by North Carolina State University.
www.ces.ncsu.edu/hil/hil-8100.html
- **Composting in Schools**
The reader will learn in detail the science and engineering of composting, ideas for student research projects, composting resource materials, glossary of composting terms, and a composting quiz! There are numerous science project lessons for students in grades 6 through 12.
<http://compost.css.cornell.edu/schools.html>
- **The National Gardening Association**
RotWeb! provides detailed information about home composting and a how-to guide for starting a composting system. The reader will also find a resource book list and information on demonstration sites. Rot Web is interested in listing your classroom's project on its website.
www.kidsgardening.com

- **www.mastercomposter.com**
You will find appropriate methods for composting organic materials, instructions for building bins, information on vermicomposting, and information on compost methods other than piles or worm bins. The “Find Your Local Program” search function allows you to search for contacts and training programs in your local area.
www.mastercomposter.com

•• Agriculture

- **California Foundation for Agriculture in the Classroom**
Information on teacher training, student programs, and resource materials support the California Foundation for Agriculture in the Classroom’s outreach to educators and students.
www.cfaitc.org/

•• Garden/School Garden

- **Composting: Nature’s Recycling Program**
Environmental Defense describes how to start a waste prevention initiative in your school, giving the public information about what to compost, how compost is made, and needed supplies, as well as a case study and a quiz to test your compost knowledge.
www.environmentaldefense.org/article.cfm?contentid=2037
- **Garden in Every School Registry**
Register your school garden, or identify existing gardens in your area.
www.kidsgardening.com/school/searchform.asp

- **Instructional School garden Grants**
The California Department of Education Nutrition Services Division supports and encourages a garden in every school.
www.cde.ca.gov/fg
- **School Gardens**
The University of California Cooperative Extension of San Diego County provides resources, tips, and activities specific to elementary school gardens.
<http://commserv.ucdavis.edu/CESanDiego/SchlGrdn/HomePage.html>
- **Urban Agriculture Notes: School Gardens**
Canada’s Office of Urban Agriculture provides examples of how to maintain a school garden and the benefits it creates as a living learning center for children.
www.cityfarmer.org/schgard15.html
- **School Garden Teacher Training and Support**
The Occidental Arts and Ecology Center provides teacher training and support for school gardens in Sonoma County and around the Bay Area.
www.oaec.org/OAEC_Services.html
- **The Edible Schoolyard**
The working garden at Martin Luther King Middle School in Berkeley, California, teaches school children, along with the community, the value of nature, gardening, and working together. Children work in the garden and help prepare meals from produce grown on site.
www.edibleschoolyard.org/
- **Youth Garden Grants**
The National Gardening Association offers 400 garden grants annually throughout the United States.
www.kidsgardening.com/grants.asp

•• Miscellaneous

• Resources for Students and Teachers

Alameda County Waste Management Authority offers free worm bins and compost bins, along with many other free resources and information on field trips and school grants, for teachers and schools in Alameda County.

www.stopwaste.org/fseducate.html

• Earthworm Ecology in California

Interesting information is presented on relatives of the red worm—earthworms!

<http://danr.ucop.edu/ihrmp/oak99.htm>

• Food Scrap Management

The California Integrated Waste Management Board offers food scrap prevention tips and suggestions for both on- and off-site composting.

www.ciwmb.ca.gov/FoodWaste/

• Integrated Environmental Studies

Environmental Education, Native American Lands: A Cultural Approach to Integrated Environmental Studies is a comprehensive lesson plan, which includes several activities encompassing waste management. Check out lessons 46, 47, and 48 on school composting, vermiculture, and school gardening. By participating in these activities, primary and secondary grade students will understand the process and benefits of how waste materials become useful to the soil through decomposition.

www.epa.gov/epaoswer/non-hw/tribal/educout.htm#k12

• Junior Master Gardener

Junior Master Gardener is an international youth gardening program that uses fun activities to teach horticulture and environmental science concepts.

www.jmgkids.com

• The Master Gardeners

The University of California Cooperative Extension's Master Gardeners Program provides seminars, workshops, demonstrations, and plant clinics on gardening/horticultural science to groups of all ages. The page also provides numerous links for the consumer and backyard grower.

<http://fruitsandnuts.ucdavis.edu>

• United States Department of Agriculture: Browse USDA Web Site by Subject

The United States Department of Agriculture site addresses issues such as food recovery and nutrition education.

www.usda.gov/subject/subject.html

• Worm Talk!

Post questions and answers about a variety of worm-related topics on this site belonging to the Happy D Ranch Worm Farm.

www.happydranch.com/wormtalk/index.cgi

Appendix C

••• Reuse Options

• California Materials Exchange

California Materials Exchange (CalMAX) is a statewide materials exchange program sponsored by the California Integrated Waste Management Board and is generally advertised as “the waste-not want ads” for businesses, industry, nonprofit organizations, and institutions.”

(877) 520-9703 (toll-free)

calmax@ciwmb.ca.gov

www.ciwmb.ca.gov/CalMAX/

- **KidMAX**

KidMAX is a specific part of CalMAX and is the catchphrase for promoting CalMAX in California's schools. KidMAX offers free and/or bargain-priced materials and free advertisements (for wanted or available materials).

(877) 520-9703 (toll-free)

calmax@ciwmb.ca.gov

[www.ciwmb.ca.gov/CalMAX/
KidMAX.htm](http://www.ciwmb.ca.gov/CalMAX/KidMAX.htm)

- **California Local Material Exchange (MiniMAX) Programs**

The MiniMAX program provides local material exchange listings for specific counties throughout the state that includes a variety of reuse and recycling resources that will help California public school teachers and administrators. From art supplies and computers to environmental curricula, teachers and school administrators will find resources to enrich their classrooms.

[www.ciwmb.ca.gov/CalMAX/
MiniMAXs.htm](http://www.ciwmb.ca.gov/CalMAX/MiniMAXs.htm)

- **L.A. County Materials Exchange Program**

Jennifer Nguyen

L. A. County Department of Public Works
Environmental Programs Division

900 S. Fremont Avenue, 3rd Floor Annex
Alhambra, CA 91803-1331

(626) 458-2196

Fax: (626) 458-3593

JENGUYEN@dpw.co.la.ca.us

www.ladpw.org/epd/lacomax/

- **Napa County Materials Exchange Program**

City of Napa Public Works
Department Waste Reduction
and Recycling Coordinator
P.O. Box 660

Napa, CA 94559-0660

(707) 257-9520 ext.7291

Fax: (707) 257-9522

kmiller@cityofnapa.org

- **Santa Cruz County Materials Exchange Program**

Contact: Ecology Action

P.O. Box 1188

Santa Cruz, CA 95061-1188

(831) 426-5925 ext. 28

vaguilar@ecoact.org

www.ecoact.org/temp/zero_waste/promax.html

- **Shasta County Materials Exchange Program**

Contact: The City of Redding

P.O. Box 496071

Solid Waste Utility

2255 Abernathy Lane

Redding, CA 96049-6071

(530) 224-6201

fsmith@ci.redding.ca.us

www.grn.com/exch/aa027669.html

- **Sonoma County Materials Exchange Program**

Contact: Sonoma County Waste
Management Agency

575 Administration Drive, Room 117A
Santa Rosa, CA 95403

(707) 565-3668

Eco-Desk Hotline: (707) 565-DESK (3375)

sonomax@ap.net

www.recyclenow.org/sonomax/

- **Solano-Napa Builder's Exchange**

135 Camino Dorado

Napa, CA 94558

(707) 255-2515

Fax: (717) 255-2749

<http://evp@snbe.com>

- **Ventura County Materials Exchange Program**

Contact: Ventura County Solid Waste
Management Department

800 S. Victoria Avenue

Ventura, CA 93009-1650

(805) 648-9226

Fax: (805) 648-9233

www.vcmx.org

❖ School- and Vermicomposting-Related Reuse Stores

There are many school- and vermicomposting-related reuse stores that carry different types of materials useful for teachers and/or schools. An “NP” designation indicates a group’s nonprofit status, and “GOV” indicates a governmental agency.

••Art Supplies and Materials

• Art from Scrap (NP)

Community Environmental Council
302 East Cota
Santa Barbara, CA 93101
(805) 884-0459
Fax: (805) 884-1879
afs@rain.org
www.communityenvironmentalcouncil.org/artfromscrap/

• Creative Reuse, North Bay (NP)

P.O. Box 1802
Santa Rosa, CA 95402-1802
(707) 546-3340

• East Bay Depot Center for Creative Reuse (NP)

6713 San Pablo Avenue
Oakland, CA 94608
(510) 547-6470
Fax: (510) 655-6536
www.eastbaydepot.com

• Scroungers’ Center for Reusable Art Parts (SCRAP) (NP)

801 Toland Street
San Francisco, CA 94124
(415) 647-1746
Fax: (415) 587-1768
scrap@storyvault.org
www.scrap-sf.org

• Student Creative Recycle Art Program (S.C.R.A.P.) Gallery (NP)

Riverside County Fairgrounds

46-350 Arabia Street

Indio, CA 92201

(760) 863-7777

Fax: (760) 863-8973

scrapgallery@earthlink.net

www.nonprofitpages.com/scrapgallery

•• Book Supplies

• Books for the Barrios (NP)

Books for the Barrios delivers mass quantities of quality educational materials, procured from donor individuals and the discards of U.S. public school districts, to the most remote disadvantaged schools in developing countries.

1125 Widget Lane
Walnut Creek, CA 94598
(925) 687-7701
Fax: (925) 687-8298
joinus@booksforthebarrios.com
www.booksforthebarrios.com/

• Sacramento Surplus Book Room (NP)

The Sacramento Surplus Book Room facilitates the collection and distribution of surplus textbooks, providing quality textbooks to schools, teachers, children, and parents.

4121 Power Inn Road
Sacramento, CA 95826
(916) 454-3459
Fax: (916) 454-0118
info@bookroom.org
www.bookroom.org

•• Food Rescue Programs

www.ciwmb.ca.gov/Reuse/Links/Food.htm

•• School Materials and Supplies

• L.A. SHARES (NP)

3224 Riverside Drive
Los Angeles, CA 90027
(213) 485-1097
Fax: (213) 485-9237
www.lashares.org

• Resource Area for Teachers (RAFT) (NP)

1355 Ridder Park Drive
San Jose, CA 95131
(408) 451-1420
Fax: (408) 451-1428
raft@raft.net
www.raft.net

Appendix D

••• Worm Bin Assembly Instructions

•• Plastic Worm Bin

Transforming a plastic storage container into a worm bin is easy. This bin can house approximately one pound of worms, which will process approximately one pound of food waste each day.

• Materials

- One nontransparent plastic storage container (21" long x 15" wide x 12" high) with a tight-fitting lid
- Four plastic bottle caps or wooden blocks (scrap wood blocks will work)
- Four 5/8" screws or "super glue"

• Tools

- Power drill with 1/4" bit

Please be safe! Wear earplugs and eye protection when drilling.

• Assembly

Drill holes in the bottom of the plastic bin, approximately three inches apart, for ventilation and drainage. Using either the screws or glue, attach one wooden block or plastic bottle cap underneath each of the four corners of the bin. These "feet" will allow air to circulate and liquid to drain from the base of the worm bin. Place a sheet of plastic or a tray underneath the bin to collect any liquid or castings. (Hint: An old TV tray or cookie sheet works great!)

•• Large Wooden Worm Bin

Build a wooden worm bin "estate"! Basic carpentry skills are required to construct this wooden worm bin, but if you follow the directions and diagrams, the project should be relatively simple. A wooden worm bin breathes well, so it may occasionally need watering to maintain the proper moisture content. This worm bin can house approximately four pounds of worms, which will process approximately four pounds of food waste each day.

• Cost

This wooden bin can be built for about \$30 with new wood and hardware, or for less money if you use recycled or scrap materials.

• Materials

Lumber

- One 4' x 8' sheet of 1/2" exterior grade plywood
- One 8-foot, 1" x 2" board

Hardware

- Thirty-two 1" galvanized screws
- Eight 1-1/2" galvanized screws
- Two 3" hinges
- Approximately 12 galvanized screws, 1/2"

• Tools

- Tape measure
- Saw
- Two sawhorses
- Long straight-edge or chalk snap line
- Power drill with 1/4" bit

Please be safe! Wear earplugs, eye protection, and a dust mask when sawing, hammering, and drilling.

• **Assembly**

Preparation

1. Measure and cut the sheet of plywood as indicated in Diagram 1. You will then have two side pieces, two end pieces, a base, and a top.

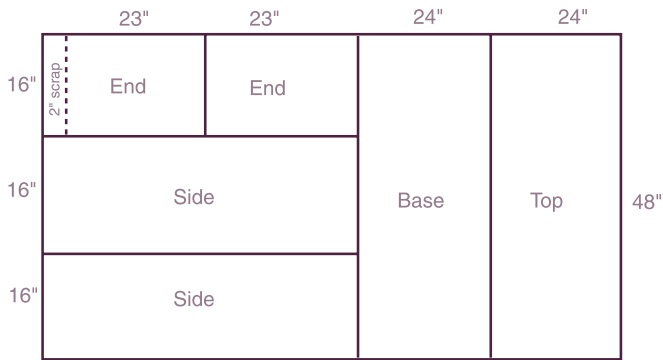

Diagram 1

Bin

1. Cut four 16" pieces from the 1" x 2" board.
2. Place the 1" side of one piece against the 16" edge of an end panel. Position the piece so it is flush against the panel edge and corners. Secure the piece to the end panel with three 1" screws. Repeat this process for the other 16" panel edge (Diagram 2).
3. Repeat step 2 for the other end panel.
4. Secure the side panels to the end panels by drilling four 1" screws through the end of each side panel into each 1" x 2" piece at each corner of the box.

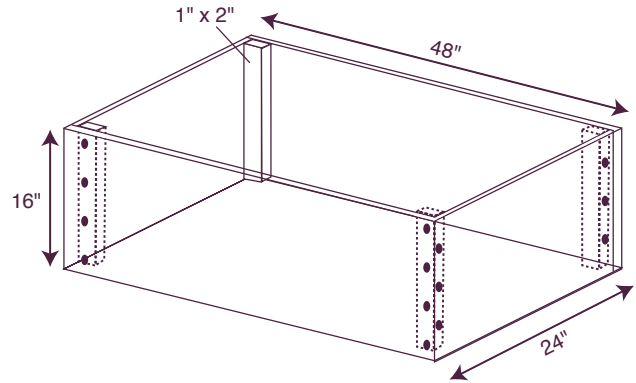

Diagram 2

Base

1. Set the base panel on top of the box "walls" so the panel edges are flush with the walls.
2. Secure the base panel to the walls by drilling one 1" screw through the panel into the 1" x 2" piece at each corner of the box.
3. Using a 1/4" drill bit, drill holes into the base panel. One hole every three to four inches should allow for sufficient ventilation.
4. Cut the remaining 1" x 2" board into two 16" pieces. These will be the "feet" of the bin.
5. Set one piece on each of the base panel's short ends, so the 2" side of each piece is against the panel.
6. Secure each 1" x 2" piece using four 1-1/2" screws.
7. Flip the box over, so that the feet are touching the ground (Diagram 2).

Lid

1. Attach the two hinges to one side of the top panel (Diagram 3) using 1/2" screws.
2. Secure the lid to the box by drilling 1/2" screws through the bottom part of each hinge into the inside of one side panel. You may need extra hands to do this!

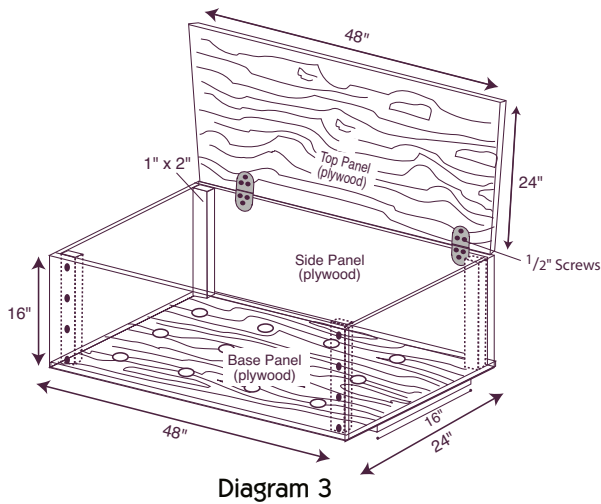

•• Cinder Block Worm Bin

Cinder blocks are a great material to use for an outdoor worm bin and can be assembled in no time at all. The blocks are very sturdy and aid in regulating the internal temperature of the bin. Also, if at a later date you decide to vermicompost with a different type of bin, the cinder blocks can be reused after a good spray-off to clean it away of castings. These are instructions for building a cinder block worm bin with the dimensions of 4' wide x 3' long x 2' high. This size bin can house approximately six pounds of worms, which will process approximately six pounds of food waste per day.

• Cost

The size bin you choose determines the cost of the materials. Determine the size by analyzing the space you have available on which to house the bin and by the amount of food you are planning to process. Cinder blocks and materials for a lid can be purchased at your local hardware store.

• Materials

Cinder Blocks

- 36 cinder blocks (12" long x 6" wide)

Note: This size cinder block will form a 4' x 3' rectangle. If your rectangle is any other size, you will need to modify the lumber sizes and instructions.

Lumber

- 4'2" x 3'2", exterior grade, 1"-thick plywood
- Two 3' lengths of 1" x 4" lumber
- Two 4'2" lengths of 1" x 4" lumber

Hardware

- 1-3/4" screws (at least 4.)
- 3/4" screws (approximately 38, depending on the number of holes in the brackets and hinges you buy)
- 4-8 L-shaped brackets (Measure the distance between the cinder block hole and the block's closest outside edge. Then add 1" to that dimension. Purchase brackets which have at least one "leg" equal to that measurement.)
- 2 hinges
- 1 latch and needed screws (optional, if you want to secure lid)
- One 85" length of 1/2"-thick chain
- Staples for heavy-duty staple gun

• Tools

- Tape measure
- Screwdriver or electric drill
- T-Square or other device to help form right angles
- Saw
- Heavy-duty staple gun

Please be safe! Wear earplugs, eye protection, and a dust mask when sawing, hammering, and drilling.

• Assembly

Select an outside area where you will house your bin. Keep convenience and ease of maintenance in mind.

Bin

1. Lay out the first layer of cinder blocks, to form a 4' x 3' rectangle (Diagram 1). Be sure to have the holes of the blocks facing upwards. Make sure the ends of the blocks are tight against one another.

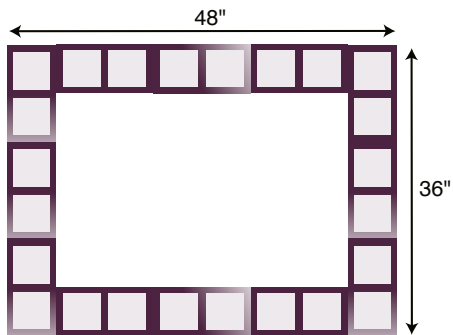

Diagram 1

2. Add the second and third layers of blocks, alternating the blocks for each layer so that the edges of the blocks line up in rows 1 and 3 only. Make sure that the top level of blocks is flush, so that the lid will lie evenly (Diagram 2).

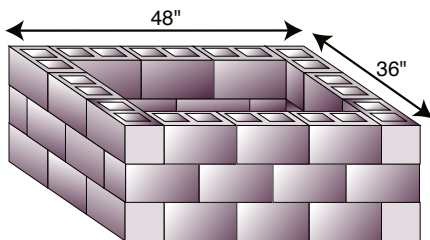

Diagram 2

Lid

1. Measure the outside perimeter of your newly formed bin to be sure it is 4' x 3', as the instructions that follow are intended for those exact dimensions.

2. To make the lid frame, screw together the 3' and 4'2" length pieces of lumber, using the 1-3/4" screws to form a rectangular frame around the rim of the cinder block bin structure (Diagram 3).

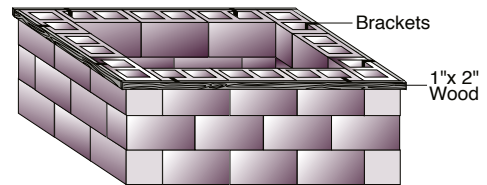

Diagram 3

3. Use four to eight brackets (either one or two on each side of the frame, depending on your preference) to secure the frame to the cinder blocks (Diagram 3). To do this, screw one leg of each bracket into the top of the frame using 3/4" screws; the other leg will extend into the cinder block hole.

4. Attach hinges to one of the 4'2" sides of the plywood lid using 3/4" screws (Diagram 4). As an option, you may decide to attach a latch to the side opposite the hinges in order to further guard against rodents and other unwanted critters.

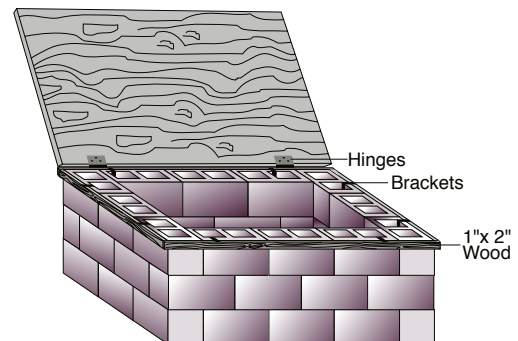

Diagram 4

5. Place the lid on top of the bin so that the hinged side is at the back and the latch side is at the front. Screw the hinges into the bin frame to secure the lid to the bin using 3/4" screws. Attach the bottom part of the latch to the front of the bin frame and check to see that it opens easily.

6. Using the staple gun, attach one end of the chain to the outside edge of one side of the bin frame. Attach the other end of the chain to the outside edge of the lid.

For additional information regarding worm suppliers, worm bin suppliers, and lessons from Closing the Loop, visit the CIWMB website at:
www.ciwmb.ca.gov/Schools/Curriculum/Worms/.

••Worm Suppliers

Our website provides the most current supplier information:
www.ciwmb.ca.gov/Organics/Worms/WrmSuply.htm

••Worm Bin Suppliers

Our website provides the most current supplier information:
www.ciwmb.ca.gov/Organics/Worms/BinSuply.htm

For additional activities, please go to our website at: www.ciwmb.ca.gov/Schools/Curriculum/Worms/



Printed on 100% Postconsumer Recycled Paper