

## RETROFITTING VENTILATION INTO LOW-RISE HOUSING

**Introduction**

Poor indoor air quality is a growing concern for homeowners. Research shows that inadequate ventilation can be one of the causes. Effective and inexpensive ways to add ventilation to existing buildings are being explored.

A research project was undertaken to find, test and verify methods of retrofitting ventilation into low-rise housing. The purpose of this project was to identify effective and economical retrofit ventilation systems and evaluate their performance. Ten example systems were investigated. The results of this project will provide industry with retrofit ventilation ideas.

The ten case studies examine the effectiveness and costs of different retrofit ventilation options for existing housing. A variety of indoor air quality problems were addressed and a variety of approaches were employed to resolve them. The table on pages 2 and 3 provides a summary of the case studies. Single-page summaries are provided in the Appendix. For full-length individual write-ups, contact the project manager at CMHC.

**Research Program**

For this project, ten single-family homes where homeowners had indoor air quality concerns were identified. In each case, a contractor or ventilation system supplier assessed the problem and installed a solution. Temperature, humidity, and CO<sub>2</sub> were measured to assess levels of ventilation within houses in their pre-retrofit condition. The measurements were taken over a two- to three-day period with normal occupancy. Short-term monitoring was also used to measure the change in ventilation with the house operating in post-retrofit condition. In one case, radon contamination was measured directly before and after the retrofit.

The retrofit costs were obtained from the contractors during the retrofit. In some cases, the retrofit was completed before the project was undertaken. The ventilation system was sealed for pre-retrofit testing when the retrofit was done earlier. Current costs were obtained either by updating the original costs or from contractor estimates in those cases.



No.	Address	Problem	Solution	Results	Installation Costs	Annual Operating Costs
1	Eden Mills, ON	<ul style="list-style-type: none"> <li>High concentrations of radon gas infiltrating from crawlspace</li> </ul>	<ul style="list-style-type: none"> <li>Draw soil gases into collection trench with fan and exhaust outdoors</li> <li>Seal soil surface with continuous membrane</li> <li>Seal sump lid and crawlspace hatch with airtight gaskets</li> </ul>	<ul style="list-style-type: none"> <li>Radon gas concentrations reduced almost 95% from 15.8 pCi/L down to 1 pCi/L</li> <li>Surface sealing alone did not provide significant radon concentration reduction</li> </ul>	\$2,450	\$79
2	Waterloo, ON	<ul style="list-style-type: none"> <li>Poor indoor air quality and moisture in basement apartment</li> <li>Odour infiltrating to main floor</li> </ul>	<ul style="list-style-type: none"> <li>Exhaust-only fan with multiple pick-up point and timer</li> <li>Exhausting from basement draws air from main floor</li> </ul>	<ul style="list-style-type: none"> <li>Overnight CO<sub>2</sub> reduced by 45% in basement apartment</li> <li>Tenants report fresher, less humid air</li> <li>Less odours to main floor</li> </ul>	\$750	\$171
3	Cayuga, ON	<ul style="list-style-type: none"> <li>Owner concerned symptoms including colds, dryness and static</li> </ul>	<ul style="list-style-type: none"> <li>Install heat-activated damper in outdoor air duct connected to furnace return</li> <li>Exhaust duct without damper connected to furnace supply</li> </ul>	<ul style="list-style-type: none"> <li>Air change rates increased especially on mild calm days</li> <li>Adding mechanical ventilation increases fresh air supplied</li> </ul>	\$326	\$66
4	Brantford-1, ON	<ul style="list-style-type: none"> <li>Excess condensation and mold growth in second floor bathrooms</li> </ul>	<ul style="list-style-type: none"> <li>Install "Mixing Box" ventilator in second floor attic</li> <li>Humidity control activates ventilation mode providing fresh air on demand</li> <li>Recirculation only when humidity low</li> </ul>	<ul style="list-style-type: none"> <li>CO<sub>2</sub> concentration reduced 50%</li> <li>Drafts could be a concern in cold weather</li> <li>Serviceability and duct leakage a concern with attic mounted equipment</li> </ul>	\$1,745	\$430
5	New Dundee, ON	<ul style="list-style-type: none"> <li>Homeowners concerned noticeable staleness indicative of poor IAQ</li> <li>Excessive moisture causing condensation on windows</li> </ul>	<ul style="list-style-type: none"> <li>HRV retrofit to provide balanced ventilation with heat recovery</li> <li>Furnace system used to distribute ventilation air</li> </ul>	<ul style="list-style-type: none"> <li>15 L/s increase in overall ventilation flow</li> <li>CO<sub>2</sub> reduced 14%</li> <li>Condensation on windows eliminated</li> </ul>	\$1,750	\$60

No.	Address	Problem	Solution	Results	Installation Costs	Annual Operating Costs
6	Conestogo, ON	<ul style="list-style-type: none"> <li>Poor air quality, stuffiness in basement</li> <li>Possible mold growth in basement bedrooms</li> </ul>	<ul style="list-style-type: none"> <li>Fresh air from first floor mixed into basement by operating furnace fan intermittently</li> <li>Furnace cycling control activates fan at set intervals</li> </ul>	<ul style="list-style-type: none"> <li>Overnight build-up of CO<sub>2</sub> reduced by 25%</li> <li>Humidity and odours significantly reduced</li> </ul>	\$275	\$27
7	Toronto, ON	<ul style="list-style-type: none"> <li>Older house had energy-efficient retrofit</li> <li>Adequate supply of fresh air was to be ensured</li> </ul>	<ul style="list-style-type: none"> <li>Install HRV to exhaust from high moisture areas</li> <li>Supply fresh air to second floor bedrooms</li> </ul>	<ul style="list-style-type: none"> <li>Overnight CO<sub>2</sub> reduced by 50% in bedrooms</li> <li>Installation of equipment in attic makes servicing difficult</li> </ul>	\$2,825	\$80
8	Brantford-2, ON	<ul style="list-style-type: none"> <li>Contaminants from home office equipment compromising IAQ</li> <li>Fresh air not distributed well throughout house</li> </ul>	<ul style="list-style-type: none"> <li>Exhaust-only ventilation system with pick-up at pollutant source</li> <li>Depressurization provides fresh air via infiltration throughout house</li> </ul>	<ul style="list-style-type: none"> <li>CO<sub>2</sub> reduced by 30%</li> <li>Mechanical ventilation provides 0.48 ACH</li> <li>Air quality in basement and remainder of house improved</li> </ul>	\$602	\$260
9	Elmira, ON	<ul style="list-style-type: none"> <li>Stuffy air in bedrooms</li> <li>Condensation on windows</li> <li>Mold growth on bathroom ceiling</li> </ul>	<ul style="list-style-type: none"> <li>Install HRV in unfinished basement</li> <li>Modified HRV installation to eliminate continuous furnace fan operation</li> <li>Stale air drawn from furnace return, fresh ducted to supply</li> </ul>	<ul style="list-style-type: none"> <li>Overnight CO<sub>2</sub> peaks reduced from 1,000 ppm to 500 ppm</li> <li>Overnight RH peaks reduced from 45% to 35%</li> <li>Owners report noticeable improvement in freshness of air in house</li> </ul>	\$1,345	\$117
10	Wilsonville, ON	<ul style="list-style-type: none"> <li>Owner wanted to control ventilation to reduce humidity on demand</li> <li>Concerned that wood stove was causing furnace to back draft</li> </ul>	<ul style="list-style-type: none"> <li>Install motorized damper in fresh air supply duct to furnace return</li> <li>Cycle control runs furnace fan on regular, periodic basis</li> <li>Damper opens when fan operating inducing fresh air</li> </ul>	<ul style="list-style-type: none"> <li>Peak CO<sub>2</sub> reduced by 50%</li> </ul>	\$945	\$62

## Implications For Renovators and Renovation Contractors

The ten case studies show that a wide range of technically-effective and cost-efficient retrofit systems for improving indoor air quality are available. These case studies in themselves, however, do not provide the whole picture. The assumption implicit in any of these studies is that the situation was reviewed in sufficient detail to accurately diagnose the problem and prescribe an appropriate solution.

The contractor needs to consider a number of issues before choosing the retrofit ventilation system to be installed in an existing house. These issues include:

1. Determine that the problem is one that additional ventilation will resolve. For example, condensation on double pane windows and mold growth may be indicative of high humidity levels that need to be dealt with before adding ventilation. Lingering odours, stuffy rooms, may be indicative of a need for additional ventilation.
2. Decide how much ventilation is required to overcome the indoor air quality (IAQ) problem. This is usually difficult to determine, though sources such as F326 will certainly provide good guidance.
3. Determine how leaky the existing house is and whether the ventilation concern is one of poor distribution or inadequate ventilation quantities, or a combination of the two.
4. Based on the contaminants of concern, the leakiness of the house and the amount of air needed will determine a strategy to be implemented. Here the case studies may be helpful in providing some options to consider. In houses with spillage-susceptible combustion appliances, consideration needs to be given to ensuring the house is not placed under a negative pressure.
5. Leaky houses may need improved air distribution more than additional ventilation air. Operating the furnace fan can move air around the house. Using a fan cycle timer can provide the distribution required while limiting the fan operating time and cost.
6. In tighter houses, some form of supply air may be required. Using an intermittent furnace cycling control in conjunction with a fresh air supply duct and motorized damper can provide an inexpensive means of supplying fresh ventilation air. A heat recovery ventilator (HRV) on the other hand, provides heat recovery but is somewhat more expensive to install. Using only the HRV fans for distribution through the supply side of the furnace ducting can further reduce operating costs.
7. Be careful of locating equipment in inappropriate locations, such as attics or poorly accessible crawl spaces. In two case studies equipment was installed in the attic. It is unlikely that the equipment will be serviced adequately, due to difficulties in access. Attic installations are also more problematic because of air leakage, high temperatures in summer, and freezing in winter.
8. Installation costs for the different options were found to range from about \$300 to about \$3,000. Operating costs range from about \$30/yr to over \$400 annually.

**SUMMARY #1—EDEN MILLS**

**Problem**

The homeowners were concerned with high concentrations of radon gas (a known carcinogen) measured within their house.

**Solution**

The entry of soil gas into crawlspace under house was minimized by sealing major migration locations, including the soil surface, using polyethylene sheeting, and sump lid and crawl space hatch using tight-fitting gaskets. Additionally, soil gasses from under the sealed polyethylene sheeting were collected in a stone-filled trench and perforated piping and exhausted by a fan.

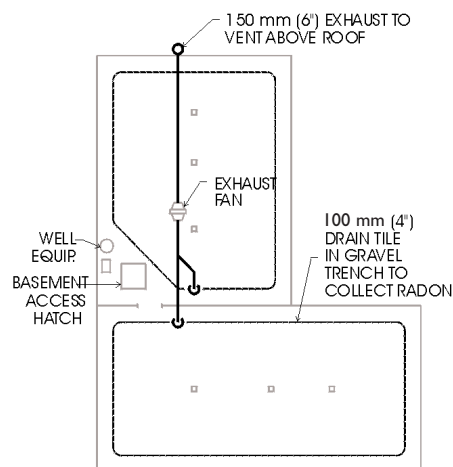

**Radon Removal System**

**Methodology**

Trenches were dug in the crawlspace following the house perimeter. A 100-mm (4") diameter perforated weeping tile was installed in the bottom of the 300-mm (12") wide x 200-mm (8") deep trench. The weeping tile was encased in pea gravel filling the trench.

The weeping tile was connected to the suction side of an in-line centrifugal fan rated 66 L/s (140 CFM) at an external static pressure of 187 Pa (0.75" W.C.). Soil gasses captured by the perforated weeping tile were exhausted outdoors through a 150-mm (6") diameter duct that extends above the eaves.

The surface of the soil was covered with 6-mil polyethylene sheeting. All the joints in the sheeting were sealed with an acoustical sealant and the edges of the sheeting were sealed to the foundation walls. The sump-pit lid and access hatch cover were sealed using airtight gaskets.

**Results / Comments**

Radon gas concentrations were measured using an electronic monitor manually read three times per day, and were reduced from 15.8 pCi/L ("picoCuries per Liter") to 1 pCi/L, a reduction of almost 95%. The current measured level within the house is well under 21.6 pCi/L—the Canadian guideline, and 4 pCi/L—the American guideline for indoor environments. A combination of sub-surface depressurization and sealing the surface of the crawl space significantly reduced radon concentrations while surface sealing alone did not.

**Costs**

**Installation and Operating Costs**

Item	Homeowner Costs
Total Installation Costs	\$2,450
Total Annual Operating Costs	\$ 79

**SUMMARY #2—WATERLOO**

**Problem**

The homeowner was concerned about the indoor air quality in their basement apartment. Tenants complained of odour and moisture build-up. Cooking odours from the basement apartment were also noticeable on the main floor.

**Solution**

An exhaust-only ventilation system was installed with multiple pick-up points dedicated to the basement apartment. The system exhausts air from the basement and draws air down from the main floor, changing natural ventilation flows in the house. The system introduces ventilation into the basement while simultaneously reducing exfiltration through upper parts of the house. The new ventilation rate is less than the sum of the original infiltration rate and mechanical ventilation added.

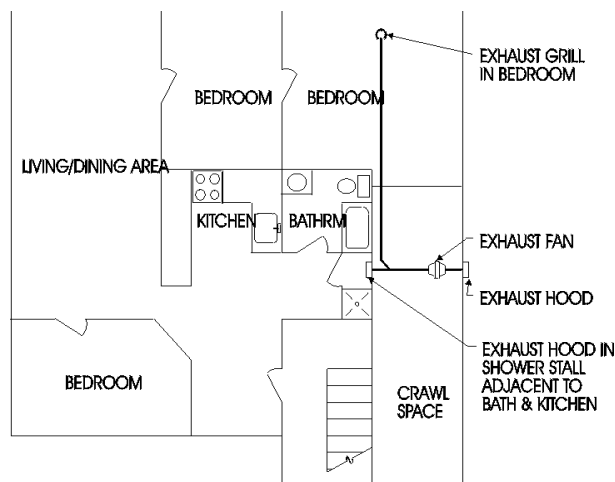

**Exhaust Layout**

**Methodology**

A 100 L/s (210 CFM) exhaust fan was installed in a crawlspace adjacent to the basement apartment. Two exhaust grilles were installed—the first in a shower stall and the second in a bedroom. To minimize operating costs, the exhaust fan operates on an event timer based on the occupant’s weekday (on at 4:00 p.m.; off at 8:00 a.m.) and weekend (24 hrs/day) schedule.

**Results / Comments**

The ventilation retrofit reduced overnight build-up of CO<sub>2</sub> by approximately 45%. The tenants confirmed that the air in the basement apartment seemed fresher and less humid. There have been less odours coming from the apartment since the retrofit.

**Costs**

**Installation and Operating Costs**

Item	Homeowner Costs
Total Installation Costs	\$750
Total Annual Operating Costs	\$171

## SUMMARY #3—CAYUGA

### Problem

Occupants were concerned that health symptoms were caused by insufficient ventilation resulting in poor indoor air quality.

### Solution

An outside air duct was connected to the furnace return to provide outdoor air to the house. The “Fresh Air Control System” (Wait Model 970) is a heat-activated damper that opens the intake duct only when the furnace is operating. An exhaust duct to outside from the furnace supply duct was installed without a damper.

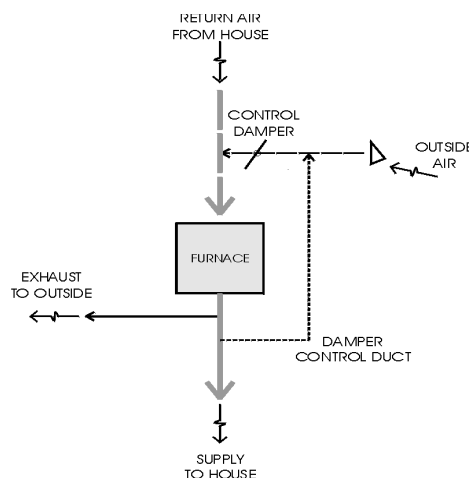

**Fresh Air Control System**

### Methodology

A 150-mm (6") diameter insulated duct is connected from an outdoor hood to the furnace return. A 100-mm (4") diameter uninsulated duct is connected from the supply air duct to the outdoors. The furnace fan operates continuously at low speed, cycling to high speed on a call for heating or cooling. The “Fresh Air Control Damper” is installed in the fresh air intake duct just upstream of the furnace return. When the damper is not activated, it is held open at a minimum setting to allow some fresh air to be drawn in.

A 75-mm (3") diameter bypass duct runs from the furnace supply air duct to the “Fresh Air Control Damper”. Air continuously circulates through this bypass duct passing over a bimetal operator in the damper. During a heating cycle, the heated bypass air causes the bimetal operator to open the damper blade so a larger volume of make-up air is then drawn into the furnace.

The 100-mm (4") diameter exhaust provides relief of over-pressure in the house caused by the intake duct. It is recognized that during certain points of operation, some heated house air is exhausted.

### Results / Comments

CO<sub>2</sub> tracer gas measurements show that even a leaky house has virtually no ventilation on mild, calm days, that mechanical ventilation can introduce adequate levels of ventilation, and combining mechanical and natural ventilation can produce higher air exchange rates than either alone.

### Costs

#### Installation and Operating Costs

Item	Homeowner Costs
Total Installation Costs	\$326
Total Annual Operating Costs	\$ 66

## SUMMARY #4—BRANTFORD 1

### Problem

The homeowners identified indoor air quality as a concern based on excessive condensation on the windows and mold growth in the second floor bedrooms.

### Solution

A “Mixing Box” ventilator (Nutech VentMax air exchanging ventilator) with ventilate/recirculate functions was mounted in the attic. A humidity control is used to activate the “ventilation” function on demand.

### Methodology

Air is drawn from the three bedrooms on the upper floor and supplied to the upper floor hallway when in recirculate mode. If the humidity rises above the set-point of the hallway-mounted controller, the ventilator switches from low to high airflow and opens the outdoor damper. Outdoor air is blended with the air being recirculated from the bedrooms. A portion of the blended air is exhausted outside to balance the ventilation flow. When humidity falls below the set-point, the unit returns to low speed, and closes the outdoor air damper.

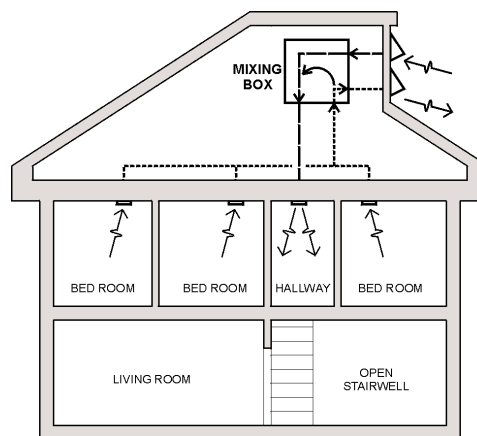

**Mixing Box Installation**

### Results / Comments

A CO<sub>2</sub> concentration reduction of almost 50% was found after the mixing box was switched on. Bedroom temperatures were reduced slightly during this relatively mild period. Calculations show that the tempered air at -20°C outdoor conditions could be delivered at under 10°C possibly causing cold drafts. Consideration should be given to issues such as equipment serviceability and potential duct leakage for any equipment that may be installed in an attic.

### Costs

#### Installation and Operating Costs

Item	Homeowner Costs
Total Installation Costs	\$1,745
Total Annual Operating Costs	\$ 430



**SUMMARY #5—NEW DUNDEE**

**Problem**

The homeowners had concerns about poor indoor air quality based on a perceived air staleness and excessive humidity.

**Solution**

An HRV was retrofitted to provide balanced mechanical ventilation with heat recovery. The furnace fan and supply ducting was used to effectively distribute fresh air to every room in the house.

**Methodology**

A standard HRV was installed in the basement with outdoor supply and exhaust hoods installed through the rim joist. Fresh supply air and stale exhaust air are both connected to the existing furnace return duct with the exhaust connection being upstream of the supply to eliminate short circuiting. Distribution of fresh ventilation air occurs via the furnace supply ducting using the furnace fan on low speed continuously. The HRV is operated on low speed for 20 minutes per hour and is turned off for 40 minutes. A dehumidistat turns the HRV on high speed when humidity levels rise.

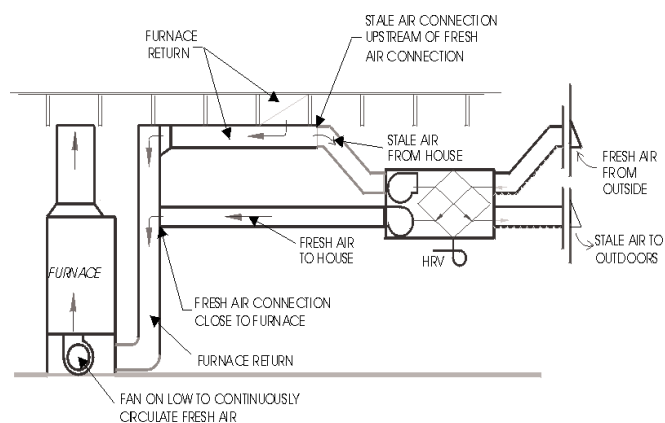

**HRV Retrofit**

**Results / Comments**

Quantitative results show an average 15 L/s increase in ventilation air supplied to the house and a 14% decrease in CO<sub>2</sub> concentrations. Quantitatively, the homeowners found that humidity levels in the house were reduced as condensation was practically eliminated from windows and the bedrooms felt fresher. This suggests that the increased ventilation resulted in an overall increase in indoor air quality. Ventilation air was effectively distributed throughout the house and the homeowner now has the ability to automatically or manually increase ventilation based on the humidity or other comfort factors. Heat recovery reduces annual operating costs while the continuous operation of the fan (which previously operated intermittently) increases them. An HRV is a relatively expensive piece of equipment but in the long run, heat recovery does have a payback.

**Costs**

**Installation and Operating Costs**

Item	Homeowner Costs
Total Installation Cost	\$1,750
Total Annual Operating Cost	\$ 60

**SUMMARY #6—CONESTOGO**

**Problem**

Homeowners are concerned with possible poor indoor air quality in basement bedrooms based on mold odours and stuffiness.

**Solution**

The leaky house had abundant levels of fresh air on main floor. Turning on the furnace fan mixed the house air, introducing fresh air from the main floor into the poorly ventilated basement. This was done by intermittently activating the furnace fan using a furnace fan cycling control.



**Furnace Fan Cycling Control**

**Methodology**

A commercially available special-purpose controller is retrofit to the furnace. The controller operates the furnace fan intermittently. The house air is mixed and turned over. Fresh air from the main floor is introduced to the basement. To avoid excessive fan operation, the controller turns the fan on only if the thermostat has not activated heating or cooling during the previous OFF period.

Fan on and off times are independently adjustable. The initial setting chosen was 10 minutes ON and 50 minutes OFF.

**Results / Comments**

Efficacy was quite good with overnight build-up of CO<sub>2</sub> concentrations reduced by 25%. The homeowners believe that other airborne contaminants such as humidity and odours have also been reduced significantly. Basement contaminant levels are reduced as air throughout the house is mixed. Contaminants are then carried out of the house with air exfiltrating from the main floor.

Higher efficacy could be achieved through longer fan run times. Increasing fan operating time would have an impact on the annual operating costs proportional to the increase in annual operating hours.

**Costs**

**Installation and Operating Costs**

Item	Customer Cost
Total Installation Costs	\$275
Total Annual Operating Costs	\$ 27

**SUMMARY #7—TORONTO**

**Problem**

Homeowners wanted to ensure that an adequate supply of fresh air was being supplied to the house after an energy-efficient retrofit was completed.

**Solution**

An HRV was installed in a heated attic. Exhaust vents were installed in high humidity locations and supply air was provided to the second floor bedrooms only. Ventilation air was then drawn through the remainder of the house by suction from the exhaust vents.

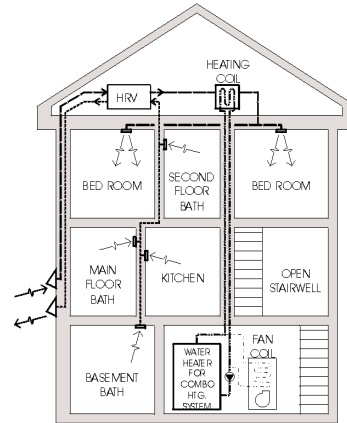

**HRV Installation**

**Methodology**

A second-storey addition was retrofit on an existing bungalow. The addition included two bedrooms, a bathroom and an insulated attic area for mechanical equipment. The building was super-insulated and airtight. An HRV was mounted in the attic with ducting placed in the walls during the renovation. Space heating was provided to the bedrooms by having the HRV blow fresh air through a fan coil-fed from a water heater.

**Results / Comments**

Building shell airtightness was better than R-2000 requirements at 1.3 ACH<sub>50</sub> (Air Changes Per Hour). The ventilation system provided approximately a 50% reduction in CO<sub>2</sub> buildup on the second floor overnight indicating a significant reduction in indoor air contaminants. Installation of the HRV was in an inaccessible space making servicing especially difficult.

No radon was detectable with the ventilation system operating. However, when the ventilation system was turned off the readings rose to about 3.5 pCi/L, below the U.S. Environmental Protection Agency (EPA) recommended action level of 4.0 pCi/L and the Canadian guideline of 21.6 pCi/L.

**Costs**

**Installation and Operating Costs**

Item	Customer Costs
Total Installation Costs	\$2,825
Total Annual Operating Costs	\$ 80

**SUMMARY #8—BRANTFORD 2**

**Problem**

Point source contaminants produced by home office equipment were compromising indoor air quality. Inadequate fresh air was being distributed throughout the house without mechanical ventilation.

**Solution**

A dedicated exhaust fan for mechanical ventilation was installed with an exhaust grille mounted near the pollutant source. Depressurization provides fresh air through infiltration in other parts of the house.

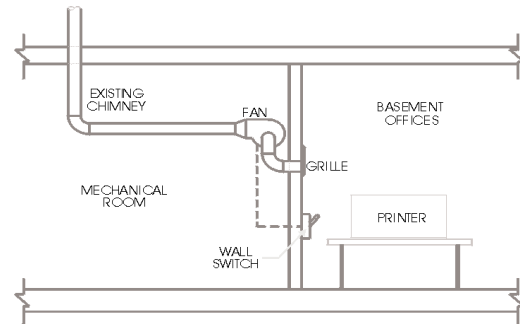

**Ventilation System**

**Methodology**

A centrifugal fan provides 66L/s (0.48 ACH) of continuous exhaust from the house. Air is extracted from immediately behind the printer and is exhausted through an abandoned metal chimney. Fan size was chosen to allow continuous air change without over-ventilating. Use of the metal chimney was a convenient coincidence that reduced installation costs because no exterior penetration was required.

Possible variations include putting the fan on a manual switch or timer. This would allow fan operation to be controlled on occupancy or on a predefined use pattern. Reducing operating time provides ventilation only when required and minimizes operating costs.

**Results / Comments**

CO<sub>2</sub> measurements show post-retrofit contaminant levels reduced by 30%. This mechanical ventilation system provides a continuous 0.48 ACH. Air quality in both the basement office and the remainder of the house has been significantly improved.

**Costs**

**Installation and Operating Costs**

Item	Customer Cost
Total Installation	\$602
Total Annual Operating Cost	\$260

**SUMMARY #9—ELMIRA**

**Problem**

Homeowners identified indoor air quality concerns based on stuffiness in bedrooms, condensation on windows and in exhaust ducts, and mold growth on the bathroom ceiling.

**Solution**

Install an HRV to provide balanced mechanical ventilation. This ventilation unit exhausts stale, moist air, and supplies fresh, dry air to the house. Heat recovery is used to minimize the costs of providing ventilation.

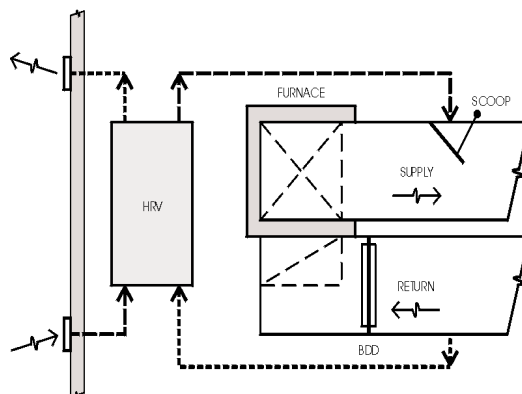

**Modified HRV Retrofit Installation**

A residential HRV was installed in the basement near the furnace. Exhaust air was drawn from the existing furnace return to draw stale air from various parts of the house. To provide effective distribution of fresh air, the HRV supply duct was connected to the furnace supply duct. An adjustable damper was installed in the furnace supply duct over the opening for the HRV connection creating a venturi to keep the HRV flow from being affected by furnace fan operation. A backdraft damper was installed in the furnace return duct downstream of the HRV exhaust to prevent fresh air from short-circuiting through the furnace to the HRV exhaust when the furnace fan is off. Using only the HRV fan to distribute fresh air reduced operating costs.

**Results / Comments**

Carbon dioxide levels in the master bedroom were reduced from nighttime peaks of approximately 1,000 ppm to 500 ppm. Relative humidity in the space was reduced from nighttime peaks of approximately 45% to 35%. The occupants also reported a noticeable improvement in the freshness of the air in the house.

**Costs**

**Installation and Operating Costs**

Item	Customer Cost
Total Installation Costs	\$1,345
Total Annual Operating Costs	\$ 117

## SUMMARY #10—WILSONVILLE

### Problem

Homeowners were concerned with occasional backdrafting due to depressurization when the wood stove was started. They also wanted to add controllable ventilation to provide humidity control.

### Solution

An outside air intake duct with a “Hoyme-VAC” motorized damper was connected to the furnace return air duct. A “Fan Recycler” timer was installed to operate the furnace fan and motorized damper, providing ventilation air on a regular, periodic basis.

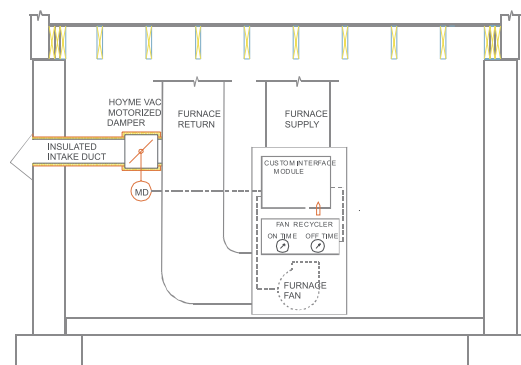

**Motorized Damper and Furnace Fan**

### Methodology

A 150-mm (6") diameter insulated duct and in-line motorized damper were connected from an outdoor intake hood to the furnace return. The furnace fan operates at low speed and the Fan-Recycler ensures the fan operates on high speed and opens the damper for a minimum 15 minutes of every 30 minutes. A custom interface constructed to adapt the Fan Recycler to the oil furnace allows the homeowner to choose between three modes of damper operation as listed below.

Mode	Description
Open	Damper always open. Provides manual override for use during wood stove operation
Heating	Damper opens on furnace burner operation, not on fan changing to high-speed
Auto	Damper opens on furnace fan high-speed operation (heating or cooling), including fan “on” override at thermostat, and furnace fan high-speed operation by Fan Recycler

*“Auto” was default for field test with the Fan Recycler operating*

### Results / Comments

Peak CO<sub>2</sub> concentrations were approximately 50% lower than those recorded before the system was installed. This potentially represents a significant decrease in the concentration of indoor air contaminants.

### Costs

#### Installation and Operating Costs

Item	Customer Cost
Total Installation	\$945
Total Annual Operating Cost	\$ 62



**CMHC Project Manager:** Don Fugler

**Research Consultants:** Enermodal Engineering Limited

### **Housing Research at CMHC**

Under Part IX of the *National Housing Act*, the Government of Canada provides funds to CMHC to conduct research into the social, economic and technical aspects of housing and related fields, and to undertake the publishing and distribution of the results of this research.

This fact sheet is one of a series intended to inform you of the nature and scope of CMHC's research.

This **Research Highlights** fact sheet is one of a wide variety of housing-related publications produced by CMHC.

For a complete list of **Research Highlights**, or for more information on CMHC housing research and information, please contact:

The Canadian Housing Information Centre  
Canada Mortgage and Housing Corporation  
700 Montreal Road  
Ottawa, ON K1A 0P7

Telephone: 1 800 668-2642

FAX: 1 800 245-9274

**OUR WEB SITE ADDRESS:** [www.cmhc-schl.gc.ca/Research](http://www.cmhc-schl.gc.ca/Research)