

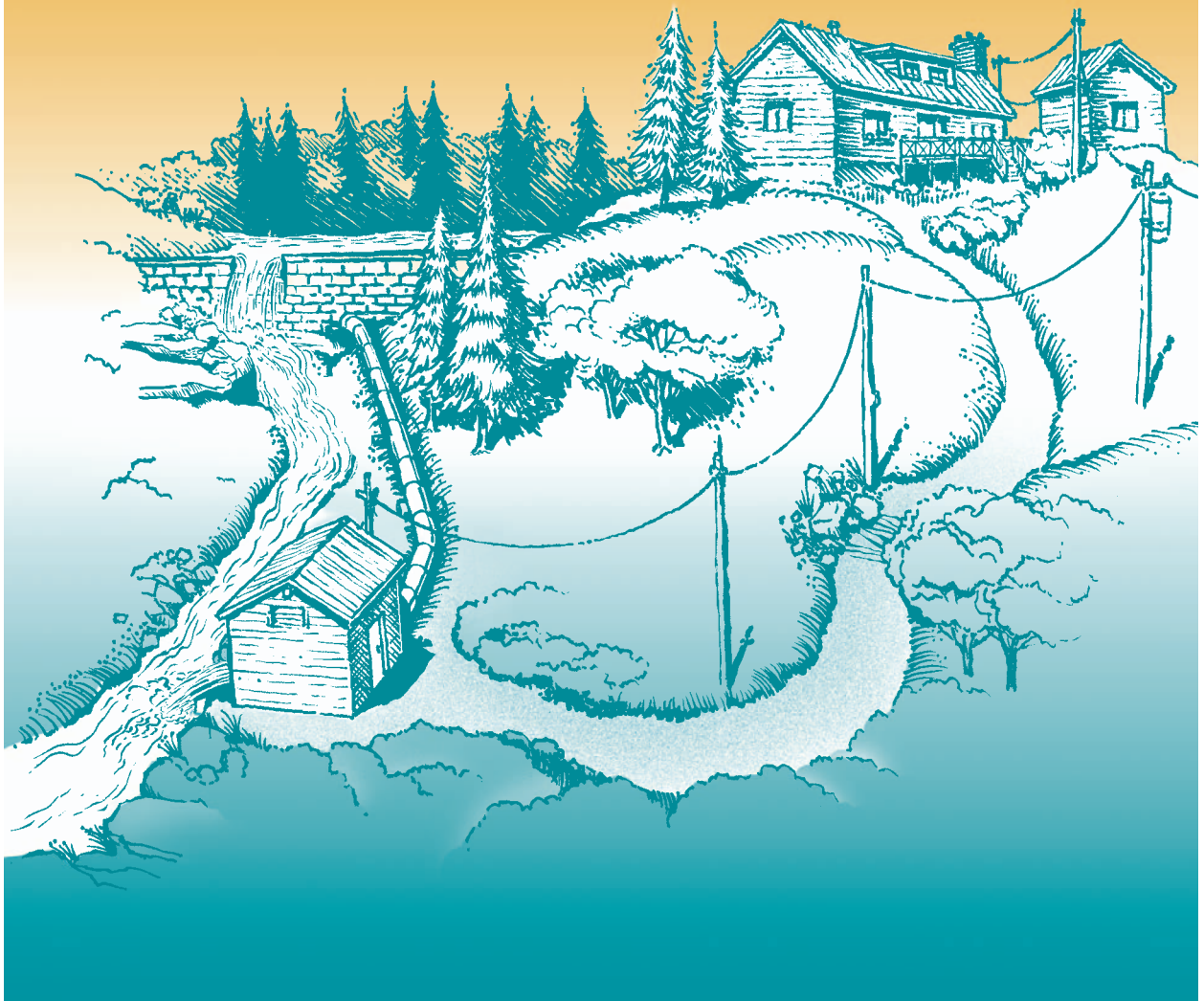

# Micro- Hydropower Systems

A Buyer's Guide



Natural Resources  
Canada

Ressources naturelles  
Canada

Canada

## ACKNOWLEDGMENTS

Text prepared by the Hydraulic Energy Program, Renewable Energy Technology Program, CANMET Energy Technology Centre (CETC) in cooperation with the Renewable and Electrical Energy Division (REED), Electricity Resources Branch, Natural Resources Canada (NRCan). Review and input from NRCan's Office of Energy Efficiency, Energy Systems & Design Inc., Homestead Hydro Systems, Morehead Valley Hydro Inc., Thompson and Howe Energy Systems Inc., Josée Bonhomme, Robert Clark, Scott Davis and Stephen Graham.

### **Micro-Hydropower Systems: A Buyer's Guide**

This guide is distributed for information purposes only and does not necessarily reflect the views of the Government of Canada or constitute an endorsement of any commercial product or person. Neither Canada nor its ministers, officers, employees or agents make any warranty with respect to this guide or assumes any liability arising from this guide.

© Her Majesty the Queen in Right of Canada, 2004

Cat. No. M144-29/2004E

ISBN 0-662-35880-5

*Aussi disponible en français sous le titre :*

Microsystèmes hydroélectriques : Guide de l'acheteur

# CONTENTS

---

<b>About This Guide</b> .....	2
<b>1.0 What Is Micro-Hydropower?</b> .....	3
1.1 Why Micro-Hydropower? .....	4
1.2 How to Identify a Potential Site .....	5
1.3 Is Micro-Hydropower for You? .....	5
<b>2.0 How to Plan for a System</b> .....	7
2.1 How to Measure Potential Power and Energy .....	7
2.2 How Small a System? .....	10
2.3 Assessing Power and Energy Requirements .....	10
2.4 Managing Energy Demand .....	12
2.5 Feasibility Study .....	13
2.6 Sizing the System .....	14
2.7 Environmental Issues and Approvals .....	15
<b>3.0 Basic Components of a Micro-Hydropower System</b> .....	17
3.1 Civil Works Components .....	17
3.2 Powerhouse Components .....	20
3.3 Drive Systems .....	23
3.4 Electronic Load Controllers .....	24
3.5 Transmission/Distribution Network .....	25
<b>4.0 Choosing a System</b> .....	26
4.1 Battery-Based Systems .....	26
4.2 AC-Direct Systems .....	28
4.3 Grid-Connected Systems .....	30
<b>5.0 Economics</b> .....	31
5.1 Initial Costs .....	31
5.2 Annual Costs .....	32
5.3 Evaluating a System .....	32
<b>6.0 Buying a Micro-Hydropower System</b> .....	34
6.1 Expert Assistance .....	34
6.2 Selecting a Supplier .....	34
6.3 Safety and Protection .....	34
<b>7.0 Installing, Operating and Maintaining a System</b> .....	36
7.1 Construction and Installation .....	36
7.2 Commissioning and Testing .....	36
7.3 Operation and Maintenance .....	37
<b>8.0 Further Information</b> .....	38
Appendix A Determining Head and Flow Rate .....	39
Appendix B Sample Data Sheet .....	44
Appendix C Typical Household Appliance Loads .....	45
Appendix D Costing Estimate Worksheet .....	47
Glossary of Terms and Abbreviations .....	48
Bibliography .....	50
Useful Web Sites .....	51
Reader Survey .....	53

## ABOUT THIS GUIDE

Micro-hydropower systems are receiving increasing interest from homeowners and others who have property that is not served by the electrical grid. This buyer's guide will help you decide if micro-hydropower is a viable option for you. It will:

- introduce you to the basics of how a micro-hydropower system works
- offer pointers on how to assess how much energy and power you need
- introduce you to the principal components of a micro-hydropower system
- outline how to determine if a micro-hydropower system makes economic sense for your circumstances
- offer some practical examples of micro-hydropower systems

This guide is not an instruction manual on how to install a micro-hydropower system; it may not provide complete information on whether a micro-hydropower system is right for your circumstances. Rather, it is a helpful introduction when considering micro-hydro systems for remote off-grid residential homes, cottages, ranches, lodges, camps, parks, small communities and First Nations communities that are not connected to an electrical grid.

Micro-hydropower systems can be complicated, are site-specific, require expertise to set up and need some degree of maintenance. You will need a qualified person to determine the feasibility of the system and its design and set-up. Before your final decision, consult government agencies and your local utility to ensure that your proposed installation meets required electrical codes, building regulations and site regulations.

## 1.0 What Is Micro-Hydropower?

Flowing and falling water have potential energy. Hydropower comes from converting energy in flowing water by means of a water wheel or through a turbine into useful mechanical power. This power is converted into electricity using an electric generator or is used directly to run milling machines. Most people in North America understand hydropower as involving big dams and large-scale generating facilities. Small-scale hydropower systems, however, are receiving a great deal of public interest as a promising, renewable source of electrical power for homes, parks and remote communities.

Hydropower technology has been with us for more than a century. Many early mills, mines and towns in Canada built some form of power generation from small hydropower systems in the late 19th and early 20th centuries.

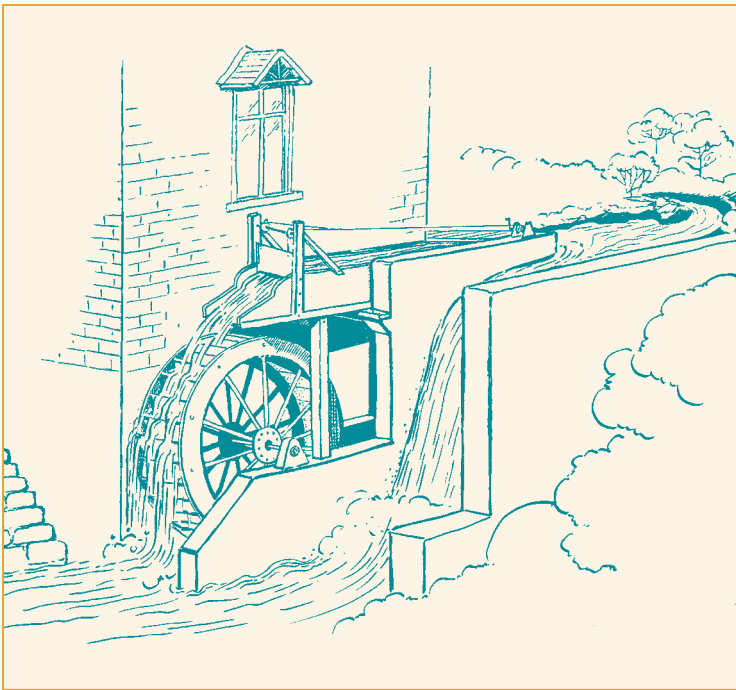

**Figure 1.** A waterwheel in action

Micro-hydropower systems are relatively small power sources that are appropriate in most cases for individual users or groups of users who are independent of the electricity supply grid. Hydropower systems are classified as large, medium, small, mini and micro according to their installed power generation capacity. Electrical power is measured in watts (W), kilowatts (kW) or megawatts (MW). A micro-hydropower system is generally classified as having a generating capacity of less than 100 kW. Systems that have an installation capacity of between 100 kW and 1000 kW (1.0 MW) are referred to as mini-hydro. Small hydro is defined as having a capacity of more than 1.0 MW and up to 10 MW, although in Canada small-hydro can be defined by provincial and territorial utilities as having a capacity of less than 30 MW or 50 MW.

Micro-hydro systems have the following components:

- a water turbine that converts the energy of flowing or falling water into mechanical energy that drives a generator, which generates electrical power – this is the heart of a micro-hydropower system
- a control mechanism to provide stable electrical power
- electrical transmission lines to deliver the power to its destination

Depending on the site, the following may be needed to develop a micro-hydropower system (see Figure 2):

- an intake or weir to divert stream flow from the water course
- a canal/pipeline to carry the water flow to the forebay from the intake
- a forebay tank and trash rack to filter debris and prevent it from being drawn into the turbine at the penstock pipe intake
- a penstock pipe to convey the water to the powerhouse
- a powerhouse, in which the turbine and generator convert the power of the water into electricity
- a tailrace through which the water is released back to the river or stream

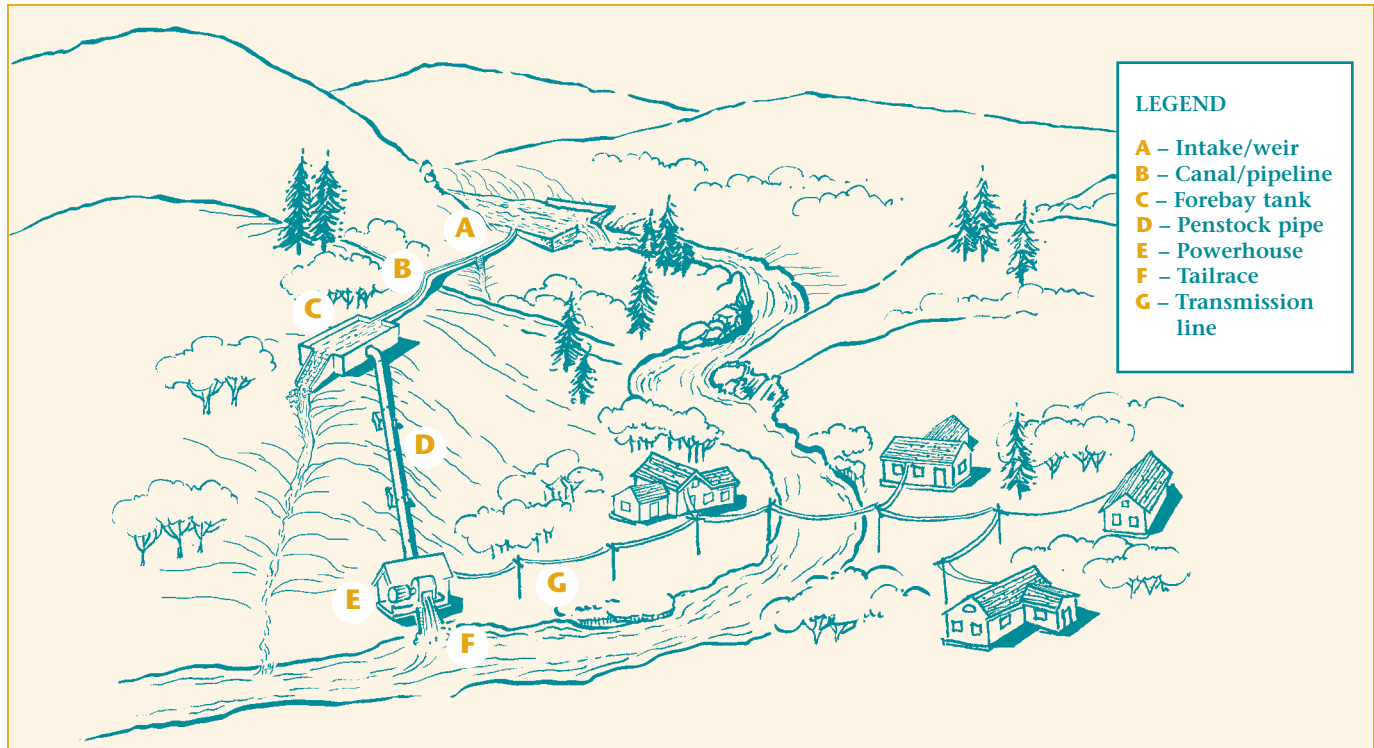

**Figure 2.** *Principal components of a micro-hydropower system*

Many micro-hydropower systems operate “run of river,” which means that neither a large dam or water storage reservoir is built nor is land flooded. Only a fraction of the available stream flow at a given time is used to generate power, and this has little environmental impact. The amount of energy that can be captured depends on the amount of water flowing per second (the flow rate) and the height from which the water falls (the head).

### 1.1 Why Micro-Hydropower?

Depending on individual circumstances, many people find that they need to develop their own source of electrical power. Canada has thousands of rivers, streams and springs that could be used to generate electricity to meet the energy requirements for off-grid rural residents, cottage owners, small communities, camp sites, parks and remote lodges.

Other renewable energy sources, such as solar and wind, can be used to produce electrical power. The choice of energy source depends on several factors, including availability, economics and energy and power requirements. Micro-hydropower systems offer a stable, inflation-proof, economical and renewable source of electricity that uses proven and available technologies. These technologies

can produce as little as 100 W of electricity at low cost and at very competitive rates, and appropriately designed and implemented systems can provide inexpensive energy for many years.

Without hydropower and other renewable energy sources, fossil fuel alone would have to meet our electricity needs. Diesel and gasoline generators are currently cheaper to buy, but the increasing cost of fuel oil and maintenance has made them expensive to operate. There is also the effect of their long-term environmental impact. Small and micro-hydropower installations have, historically, been cheap to run but expensive to build. This is now changing, with smaller, lighter and more efficient higher-speed turbine equipment, the lower cost of electronic speed- and load-control systems, and inexpensive plastic penstock pipes. Capital investments of hydropower systems are still higher than investing in diesel equipment of comparable capacity, but their long life, low operating costs and emerging renewable energy incentives make such systems an attractive investment for many applications.

There can be several reasons for wanting to build a micro-hydropower system. You may simply wish to generate electricity to fulfil your basic needs for lighting, electronic devices, computers, small appliances, tools, washing machines, dryers,

refrigerators, freezers, hot water, space heating or cooking. Over the long term, it may be more economical for you to invest in your own system rather than pay your local electricity utility for the energy you need, especially if you face a significant connection charge. Other reasons may be that you are interested in helping to protect the environment by avoiding the use of fossil fuels or that you wish to be independent of the power grid.

This guide has been prepared specifically for people who are considering off-grid power generation. Applying micro-hydropower technology in remote locations where electricity is provided by diesel generators offers an opportunity to replace a conventional fuel with a renewable energy source. If you have a stream flowing through or near your property and wonder if you could use a hydro-electric system to power your home and/or sell electricity to your neighbours, this guide is for you. It has been demonstrated that water power can produce many times more power and energy than several other sources for the same capital investment. A micro-hydropower system is a non-depleting and non-polluting energy source that has provided reliable power in the past and is one of the most promising renewable energy sources for the future.



**Figure 3.** A typical micro-hydropower weir in Cherry Creek, British Columbia

## 1.2 How to Identify a Potential Site

The best geographical areas for micro-hydropower systems are those where there are steep rivers, streams, creeks or springs flowing year-round, such as in hilly areas with high year-round rainfall. There is micro-hydropower potential in almost all of Canada's provinces and territories, although most potential is in British Columbia, Newfoundland and Labrador, Ontario and Quebec.

To assess the suitability of a site for a micro-hydropower system, a pre-feasibility study should be made. This involves surveying the site to determine the water-flow rate and the head through which the water can fall. Methodologies for measuring water-flow rate and making head measurements are outlined in Section 2 and Appendix A. The best place to start is your nearest stream, or you can refer to topographical maps and hydrological records of the area you are considering. If you are new to the area, local residents are the best source of information on the nature of the stream, flow variations during the year and any abnormal flows in the past. This will give an overall picture of annual river flow fluctuations over the seasons. If possible, flow data should be gathered over a period of at least one full year, although two to five years is ideal. Your local utility may also have an inventory listing of potential micro-hydropower sites in your area. A site survey is carried out for promising sites in order to gather information that is detailed enough to make power calculations and start design work.

## 1.3 Is Micro-Hydropower for You?

You may have wondered whether the stream flowing through or near your property can be used to generate electrical power using a hydropower system to power your home. Is a micro-hydropower system feasible for you? Many factors will determine the viability of such a system:

- local, provincial/territorial and federal legal restrictions on the development of the hydro-electric site and the use of the water
- the amount of power available from the stream and its ability to meet energy and power requirements
- the availability of turbines and generators of the type or capacity required
- the cost of developing the site and operating the system

Before deciding to build a micro-hydropower system or any other kind of electricity-generating system, it is wise to carefully evaluate all alternatives. Those available will depend on your situation and why you are interested in hydropower. In general, people who are interested in such systems fall into one of two categories:

- They may have a site that has good hydro potential and want to develop it for their own power requirements in an area where there is presently no electrical service.
- They may want to generate their own power instead of buying power from an electrical utility, or they may wish to sell the power to the local utility.

In the case where there is no electrical service, you will need to compare the cost of extending the existing electrical grid to your home or area with the cost of generating power locally. If there are only one or two homes that are quite a distance from the grid, it may be worthwhile to consider local generation. The cost of connecting to the grid depends on the distance involved; an electrical utility could charge between \$10,000 and \$50,000 or more per kilometre of transmission line required to extend the lines to connect to your home. It pays to get a quote from your local utility before deciding. The potentially high cost of connecting to the grid is one of the reasons that most stand-alone power supply systems are installed in rural areas. There will also be ongoing electricity charges if you connect to the grid.

If you wish to be independent of the power grid, check the price that you will have to pay for electrical power and the approximate cost of developing a micro-hydropower system. Compare the rate of return on your investment with investing in other kinds of generating systems, or consider investing elsewhere.



**Figure 4.** A small stream suitable for a micro-hydropower system

If there is no electrical service in your area, the principal alternative to developing a micro-hydropower system is usually to build some other kind of generating system. Your choice of technology will depend on many factors, including the long-term cost of generating electricity using each technology and appropriate consideration of their respective social and environmental costs and benefits.

If planned and designed properly, a micro-hydropower system has many advantages over most conventional means of electricity generation. Some of the most important advantages are as follows:

- The energy to run hydropower systems is almost free once they are built, even though they usually cost more to build than systems that generate electricity using fossil fuel or natural gas.
- Hydropower systems are inflation-proof because the cost of using the water in the river and stream is not likely to increase, and the cost of fuel for other systems could increase over the years.
- Hydropower systems last 20 to 30 years – longer than most other kinds of generating systems.
- Smaller projects such as micro-hydro systems can be built relatively quickly.
- As a renewable resource, a micro-hydropower system does not depend on oil, coal or other fossil fuel in order to operate. It promotes self-sufficiency because its development occurs on a much smaller scale, and most adverse environmental and social effects of large energy development projects are eliminated.
- There is no need for long transmission lines because output is consumed near the source.
- Under favourable circumstances, micro-hydropower is one of the most cost-effective forms of renewable energy.

There are other important factors you should address when deciding if a micro-hydropower system would work at a specific site:

- the potential for hydropower at the site
- your requirements for energy and power
- environmental impact and approvals
- equipment options
- costs and economics

Keep in mind that each micro-hydropower system's cost, approvals, layout and other factors are site-specific and unique in each case.



## 2.0 How to Plan for a System

If you are thinking seriously about installing a micro-hydropower system, you will want to plan a system that is sure to meet your energy and power needs. There are also various planning stages that you will need to consider. Once these initial steps are completed, you can begin preliminary system design. Many factors contribute to a successful micro-hydropower system.

### 2.1 How to Measure Potential Power and Energy

The first step is to determine the hydro potential of water flowing from the river or stream. You will need to know the **flow rate** of the water and the **head** through which the water can fall, as defined in the following:

- The **flow rate** is the quantity of water flowing past a point at a given time. Typical units used for flow rate are cubic metres per second (m<sup>3</sup>/s), litres per second (lps), gallons per minute (gpm) and cubic feet per minute (cfm).
- The **head** is the vertical height in metres (m) or feet (ft.) from the level where the water enters the intake pipe (penstock) to the level where the water leaves the turbine housing (see Figure 5).

See Appendix A for ways to measure the head and stream flow rate.

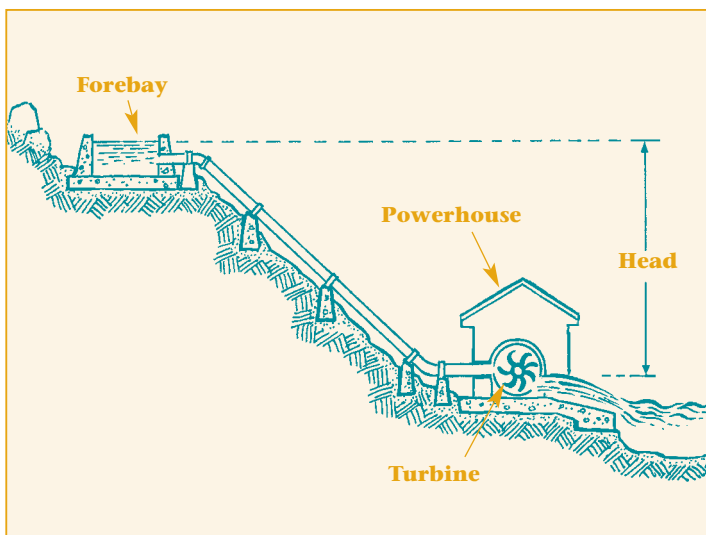

Figure 5. Head of a micro-hydropower system

### Power Calculation

The amount of power available from a micro-hydropower system is directly related to the flow rate, head and the force of gravity. Once you have determined the usable flow rate (the amount of flow you can divert for power generation) and the available head for your particular site, you can calculate the amount of electrical power you can expect to generate. This is calculated using the following equation:

$$P_{th} = Q \times H \times g$$

$P_{th}$  = Theoretical power output in kW

$Q$  = Usable flow rate in m<sup>3</sup>/s

$H$  = Gross head in m

$g$  = Gravitational constant (9.8 m/s<sup>2</sup>)

#### Example 1

A site has a head of 10 m (33 ft.) with flow of 0.3 m<sup>3</sup>/s (636 cfm or 4755 gpm); therefore, the potential power output is given by  $Q \times H \times g$  ( $0.3 \times 10 \times 9.8$ ), which is 29.4 kW.

This is only the theoretical available power, assuming that 100 percent of the power available in the water can be usefully converted. Efficiency of the system also needs to be taken into account. Energy is always lost when converted from one form to another, and all of the equipment used to convert the power available in the flowing water to electrical power is less than 100 percent efficient. To calculate the most realistic power output from your site, you must take into account the friction losses in the penstock pipes and the efficiency of the turbine and generator.

When determining the head, you will need to consider **gross head** and **net head**. Gross head is the vertical distance between the top of the penstock that conveys the water under pressure and the point where the water discharges from the turbine. Net head is the available head after subtracting the head loss due to friction in the penstock from the total (gross) head (net head = gross head – losses in the penstock).

Small water turbines rarely have efficiencies better than 80 percent. Potential power will also be lost in the penstock pipe that carries the water to the turbine because of frictional losses. Through careful design, however, this loss can be reduced to a small percentage; normally, the losses can be kept to 5 to 10 percent. Typically, overall efficiencies for electrical generation systems can vary from 50 to

70 percent, with higher overall efficiencies occurring in high-head systems. Generally, overall efficiencies are also lower for smaller systems. As a rule, the “**water to wire**” efficiency factor for small systems (for example, up to 10 kW) could be taken as approximately 50 percent; for larger systems (larger than 10 kW) the efficiency factor is generally from 60 to 70 percent. Therefore, to determine a realistic power output, the theoretical power must be multiplied by an efficiency factor of 0.5 to 0.7, depending on the capacity and type of system.

$$P = Q \times H \times g \times e$$

e = efficiency factor (0.5 to 0.7)

$$\text{Power output (in watts)} = Q \text{ (lps)} \times H \text{ (m)} \times g \times e$$

**Example 2**

A turbine generator set to operate at a head of 10 m (33 ft.) with flow of 0.3 m<sup>3</sup>/s (636 cfm) will deliver approximately 15 kW of electricity. This is given by  $P = Q (0.3) \times H (10) \times g (9.8) \times e (0.5) = 14.7 \text{ kW}$ , assuming an overall system efficiency of 50 percent.

These calculations will give you an idea of how much power you can obtain from your water resource. Table 1 shows how much electrical power you can expect with various heads and water-flow rates.

**Table 1. Typical Power Output (in Watts) With Various Head and Water-Flow Rates**

Head		Flow Rate										
		(lps)	5	10	15	20	40	60	80	100	150	200
(m)	(ft.)	(gpm)	79	159	238	317	634	951	1 268	1 585	2 378	3 170
1	3		25	49	74	98	196	294	392	490	735	980
2	7		49	98	147	196	392	588	784	980	1 470	1 960
4	13		98	196	294	392	784	1 176	1 568	1 960	2 940	3 920
8	26		196	392	588	784	1 568	2 352	3 136	3 920	5 880	7 840
10	33		245	490	735	980	1 960	2 940	3 920	4 900	7 350	9 800
15	49		368	735	1 103	1 470	2 940	4 410	5 880	7 350	13 230	17 640
20	66		490	980	1 470	1 960	3 920	5 880	7 840	9 800	17 640	23 520
30	98		735	1 470	2 205	2 940	5 880	8 820	14 112	17 640	26 460	35 280
40	131		980	1 960	2 940	3 920	7 840	14 112	18 816	23 520	35 280	47 040
60	197		1 470	2 940	4 410	5 880	14 112	21 168	28 224	35 280	52 920	70 560
80	262		1 960	3 920	5 880	7 840	18 816	28 224	37 632	47 040	70 560	94 080
90	295		2 205	4 410	6 615	8 820	21 168	31 752	42 336	52 920	79 380	105 840
100	328		2 450	4 900	7 350	9 800	23 520	35 280	47 040	58 800	88 200	117 600

## Flow Duration Curve and Energy Calculations

As an owner/developer of a potential hydro site, you may wonder how much power your site will produce. A more exact question is how much energy it will produce – it is energy in kilowatt hours (kWh) that we buy from or sell to the electricity supplier. Energy is a measure of the length of time we have used or produced a given amount of power. For example, if you use 1 kW (1000 W) of electricity for one hour, you have used 1 kWh of electrical energy. A site on a stream or river that has a highly variable flow (i.e., a wide range of flows with many highs and lows) may not produce as much energy as a river that has a smaller range of flows but that is more consistent on average. A hydrologist or professional consultant can produce a flow duration curve (FDC) for a river or stream by ordering the recorded water flows from maximum to minimum flow (as shown in Figures 6a and 6b). This is a way to show the probability in graph form of how many days in a year a particular flow will be exceeded. (The area below the curve is a measure of the energy potential of the river or stream.)

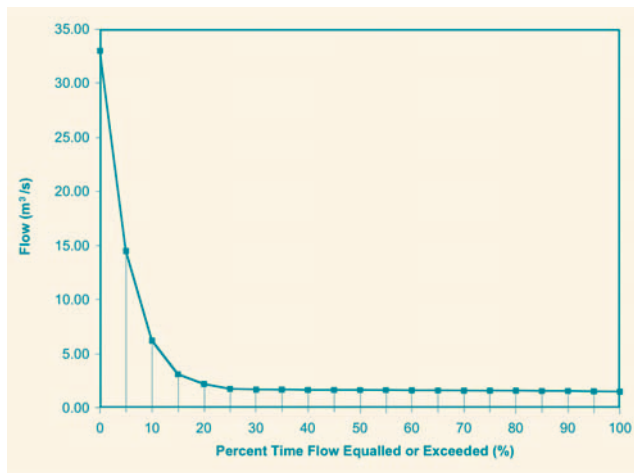

**Figure 6a.** Flow duration curve for river with a high flow for a short time

The FDC is used to assess the expected availability of flow over time and the power and energy at a site and to decide on the “design flow” in order to select the turbine. Decisions can also be made on how large a generating unit should be. If a system is to be independent of any other energy or utility backup, the design flow should be the flow that is available 95 percent of the time or more. Therefore, a stand-alone system such as a micro-hydropower system should be designed according to the flow that is available year-round; this is usually the flow during the dry season. It is possible that some streams could dry up completely at that time.

Remember that for any water source, be it a river, stream or creek, there will be a difference in flow between winter and summer, and this will affect the power output produced by a micro-hydropower system. Flow in the stream changes continually (sometimes daily) if precipitation has occurred; however, some generalizations can be made. In southern Ontario, rivers and streams are at their highest levels in early spring and are at their lowest levels in late summer. In northern Ontario and Quebec, smaller rivers and streams are usually at their lowest levels in mid-winter and at their

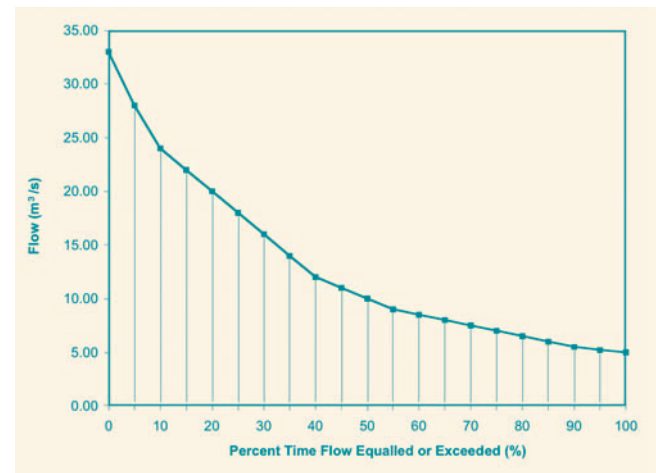

**Figure 6b.** Flow duration curve for river with more steady flow

highest in spring. British Columbia and Newfoundland and Labrador generally have low flows in late winter and high flows in the spring, except for the south coast of British Columbia, which has low flows in summer and high flows in winter. These variations must be considered in the estimated total energy generation expected from a site.

Ideally, minimum flow over the year should be taken to calculate the design flow to ensure that power is available year-round. Normally, only a fraction of the available flow in the stream is used for power generation. Therefore, FDC is less important as the size of system decreases. If the system's generating capacity is less than 10 kW or so, FDC may not be relevant at all.

## 2.2 How Small a System?

It is important to note that there is a head and a flow rate below which there is presently no economic advantage in trying to obtain electrical power. These minimum heads and flow rates are difficult to specify because a combination of high values of one with low values of the other can give some useful power. For practical purposes, however, any head less than 1 m (3 ft.) is probably going to be uneconomical to develop. Similarly, 0.60 lps (10 gpm) can be considered the lower limit for the flow rate.

The following examples illustrate how different flow rates and heads of two sites generate similar amounts of energy:

- A flow rate of 0.6 lps (10 gpm) at 35 m (100 ft.) of head will generate 100 W of useful power.
- A flow rate of 20 lps (317 gpm) at 1 m (3 ft.) of head will also deliver about 100 W of useful power.

Both of these systems would produce enough energy to light a 100-W light bulb continuously, equivalent to about 72 kWh of energy per month.

If a site has more head, less water flow is required. The more head and flow there is, the more potential power can be generated. It is helpful to discuss your situation with people who already have a micro-hydropower system and to visit these sites if possible. You can also contact manufacturers and suppliers for further information (see "Useful Web Sites" on page 51).

## 2.3 Assessing Power and Energy Requirements

In assessing the feasibility of developing a micro-hydropower system, you should carefully examine your power and energy requirements. The power you need is the instantaneous intensity of electricity required to power the appliances you use; this is measured in kilowatts. The more appliances that are used at the same time, the more power required. Energy is a measure of the length of time you have used a given amount of power. It depends on the power required by the appliances and on how long and how often you use them. Electrical energy is measured in kilowatt hours. You need to know the electrical power and energy requirement for lighting, heating, cooking and other uses for your home or lodge. Does the micro-hydropower system potential meet your power and energy needs? How large a system do you really require? Power requirements are not easy to assess correctly.

One way to determine electrical energy needs is to look at your current electricity bills, which will indicate the number of kilowatt hours that you use per month. If you are currently using a fuel-based generator for your electricity needs, record the amount of fuel the generator used in one month and how long the generator operated over the same period. Keep in mind that your electricity consumption will vary depending on the season. Therefore, you will need to calculate the total energy requirement (in kWh) for the whole year.

To estimate how much electricity you need:

- List all your electrical appliances and lights and note when and how long they are used.
- Note the power that each appliance consumes. An appliance's power rating is usually written on the back of the appliance and is measured in watts or kilowatts. The EnerGuide label found on new appliances such as refrigerators, washing machines and dishwashers also provides energy consumption ratings (in kWh per month or year).
- Record the number of hours each appliance is used in a typical day.
- For each appliance, multiply the power rating in watts by the number of hours used each day to obtain the number of watt hours (or kWh) that the appliance uses per day.

- Energy-use patterns change with the seasons (e.g., lighting is generally used more in winter).
- Add up the watt hours for all your appliances. This total is an estimate of your electrical energy consumption per day. Then you can calculate how much energy you would need per month.

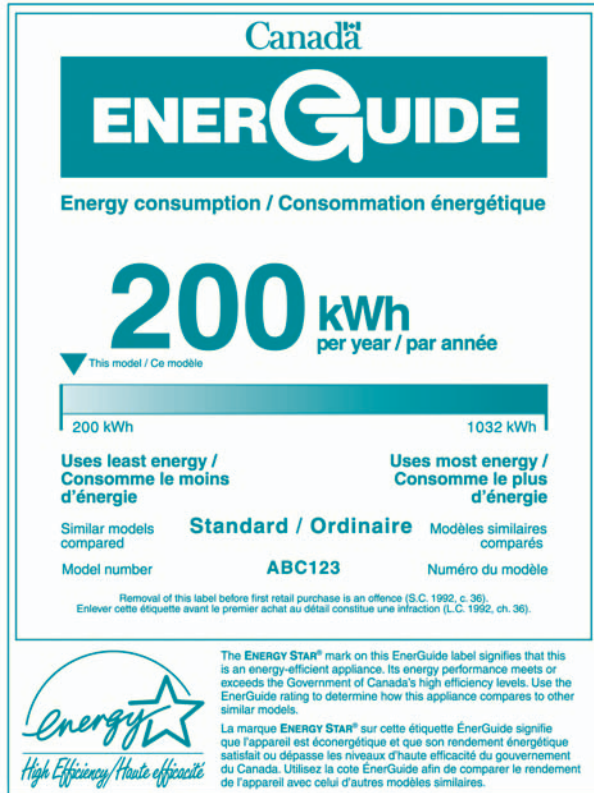

Figure 7. EnerGuide label with ENERGY STAR® symbol

Although Canada’s EnerGuide label lets you compare the energy consumption of various appliances, the ENERGY STAR® symbol – displayed alone or as part of the EnerGuide label (see Figure 7) – helps you identify those that are the most energy efficient in their class.

Another way to determine your electrical energy needs is to add up typical household appliance loads and calculate the total energy used by a typical household per month (see Table 2 and Appendix C).

It is important to work out your total energy consumption and peak power consumption because a situation may arise in which the system could meet one need but not the other. Compare your power needs with what is available from your water resource (calculate using the head and flow rate). If your monthly energy requirements are greater than the micro-hydropower system can generate in a month, see where you can reduce consumption so that it at least matches the available energy.

To estimate your peak power requirement, add the wattage rating of all appliances that might be used simultaneously. Peak power is the maximum amount of electricity that will be needed at any given moment, and this requirement normally occurs when most of the largest appliances are running at the same time. In many micro-hydropower systems, the peak power demand is more likely to define the design capacity of the turbine rather than the system energy requirements. When analysing and optimizing a micro-hydropower system, remember that conservation is the most powerful factor – ask yourself if you can make some adjustments in how and when you use electricity.

Table 2. Sample Load Analyses

Appliance	Power Rating (watts)	Hours per Day	Hours per Month	Monthly (kWh)	Annual (kWh)
Four fluorescent lamps	200	8	240	48	576
Colour television	100	4	120	12	144
Refrigerator	300	10	300	90	1080
Water pump	1000	1.5	45	45	540
Computer	200	12	360	72	864
<b>Total energy consumption</b>				<b>267</b>	<b>3204</b>

By lowering your peak demand, you can decrease the design capacity requirement of your system and significantly reduce its initial cost. You may have to adapt to new patterns and habits in order to use energy more efficiently. Remember, saving energy is always cheaper than producing more power.

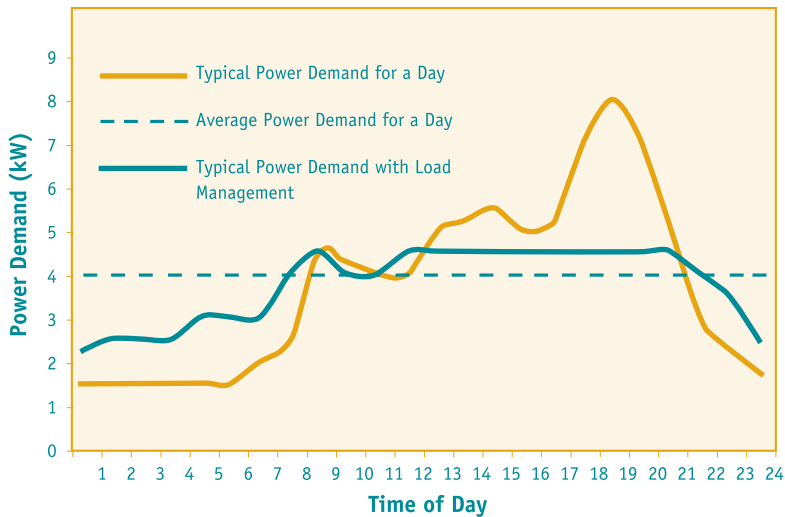

**Figure 8.** Load variation and effect of load management. Adapted from *Micro-Hydro Power: Energy from Ontario Streams*.

## 2.4 Managing Energy Demand

How much electricity is enough? For an average house that draws electricity from the grid, typical energy consumption is about 800 kWh per month (approximately 10 000 kWh per year). This does not include electricity used for space heating and cooling and for cooking. If this were included, electricity usage would be much higher. Electrical load varies throughout the day (see Figure 8). If you look at a typical residential pattern of peak load of electricity use in a home supplied by a local grid, you will see that it occurs primarily between 4:00 p.m. and 8:00 p.m., while the least-demand period is between midnight and 6:00 a.m. There is a large variation in power demand during these periods.

Average power consumption (demand) is the number of kilowatt hours used over a given period; an average power demand for a day can be calculated by dividing the total energy consumption by the total number of hours in a day (i.e., 24). Micro-hydropower systems can generally meet

electrical demand if the river or stream has sufficient flow over the drier months of the year. There will be downtime to maintain the system. By using basic energy conservation practices such as using energy-efficient appliances, you will consume much less energy. This can easily cut your use of electricity in half to 400 kWh per month (5000 kWh per year). Studies on energy-use patterns in off-grid houses have found that the average energy reduction is about 44 percent compared with houses that are supplied by the grid, and this is achieved through energy conservation.

Many household appliances use a small amount of power when in standby mode (e.g., televisions, cordless phones, computer monitors). These loads, commonly known as “phantom” loads or standby power, can easily add up to 100 W of continuous power. It is best to unplug these devices as often as possible when not in use to help reduce total electrical energy demand. The use of energy-efficient appliances and the elimination of phantom loads are much more critical with small, battery-based micro-hydropower systems.

### Load Management

Peak electricity demand can be reduced by applying energy efficiency and load-management techniques and by choosing energy sources other than electricity for energy-intensive activities such as heating and cooking. Studies of energy consumption in residential homes have shown that, on average, about 50 percent of home energy use is for space heating, 30 percent for water heating, 5 percent for lighting and 15 percent for appliances. You can gain significant benefits simply by thinking carefully about when you use various appliances. For example, do not use your washing machine at the same time that you are ironing; both are energy-intensive activities.

Various devices are available off-the-shelf that can be used for load-management applications in a micro-hydropower system and that will improve energy use and reduce peak demand. Some may come with an electronic load controller. Load controllers (see Figure 9) with load-management features have been performing effectively in off-grid larger micro-hydropower systems in Canada for many years.

These controllers allow you to manage your peak demand load by using the energy available from the system to its maximum. Typically, these management systems allow you to connect at least twice the amount of load than the capacity of the micro-hydropower system. (See Section 3.4 for information on electronic load controllers.)

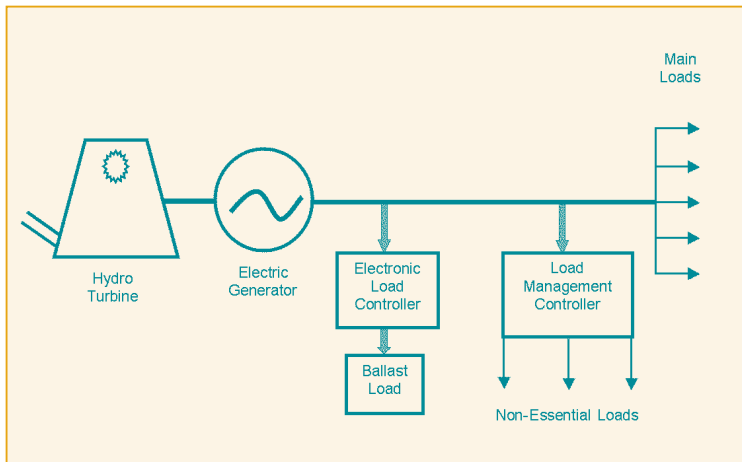

**Figure 9.** Basic set-up of load-management controller in a micro-hydropower system

For example, non-essential loads such as domestic hot water tanks, baseboard heaters and any other loads that could be automatically interrupted without causing inconvenience to the consumer can be controlled by a load-management controller. It will turn off some or all of these loads when the micro-hydropower system is becoming overloaded and automatically turn them back on when the system has surplus power. The apparent capacity of a 10-kW plant can become 20 kW with load management.

There are also devices such as distributed intelligent load controllers (DILCs), which are fitted directly in appliances such as refrigerators, battery chargers, water heaters or space heaters to distribute the loads around the system. These devices sense the frequency and the voltage of the system and switch the loads accordingly, without the risk of overloading the system. The load-management system should be part of the micro-hydropower system design. It is important to keep these energy-saving strategies in mind when considering the size of your micro-hydropower system.

## 2.5 Feasibility Study

A pre-feasibility study is carried out to determine whether the site is worth further investigation. This study could involve visiting a site to measure head and flow rate, or it could simply be a map study. If the site looks promising, the next step is to carry out a full-scale, detailed feasibility study. Information collected by this study should be of the highest quality and should be accurate enough to permit a full technical design of the project without a further visit. A feasibility study includes a site survey and investigation, a hydrological assessment, an environmental assessment, the project design, a detailed cost estimate and the final report. The depth of study will depend largely on the size and complexity of the system. For a small system such as a battery-based system, the feasibility study can be less rigorous than for a larger system.

Carrying out a feasibility study is highly technical. Unless you have a strong background and experience in the area, it is best left to professional consultants or energy experts. Such expertise may be expensive, but the project could become much more expensive without professional help. If a consultant prevents only one serious mistake in the project, that person will have earned his or her fee many times over. If you are going to call a consultant or manufacturer, make sure that you have at least a rough estimate of the head (vertical drop), length of pipe needed for the head and an approximate flow rate of your micro-hydropower site. These are the first things that you will be asked.

The feasibility study should answer as many of the following questions as possible:

- How much head is available?
- How long does the canal/pipeline have to be in order to reach the head?
- What are the minimum and maximum flow rates, and when do these occur?
- How much power can be generated with the available flow rates?
- Who owns the land?
- Where are the nearest electricity power lines?
- What would the environmental effects of installing a micro-hydropower system be?
- What is the approval process to install the micro-hydropower system?

- What financial incentives are available that encourage renewable energy, and how can you apply for them?
- How much will it cost to develop the micro-hydropower system?

Finding answers to as many questions as possible will enable you to identify any major problems before you invest a lot of time and money in the project.

During the feasibility study, all relevant technical and non-technical information needs to be collected. This includes the location of the intake, forebay tank and powerhouse; the length of the diversion canal/pipeline; the penstock; and the transmission/distribution network. The feasibility report should contain detailed technical information. Design of the system includes civil works, the penstock, generating equipment and an estimate for the total cost of the system. It is helpful to keep in mind that the cost per kilowatt increases for low-head systems, low-flow systems and for systems where a great deal of civil works components need to be constructed.

## 2.6 Sizing the System

The most important question in planning a micro-hydropower system is how much energy can be expected from the site and whether or not the site will produce enough power to meet your energy needs. For a stand-alone micro-hydropower system, it must be large enough to meet peak power consumption if you are to be energy-independent. In order to determine the size of the system you need, two types of energy estimates should be evaluated: peak demand and total energy consumption.

One way to determine the size of the generating system is to design it to meet the peak power consumption and to divert excess power at off-peak times, using an electronic load controller, into the ballast loads. The other option is to size the generator to meet or slightly exceed the average power consumption and use battery storage and an inverter to meet peak power consumption. However, if the site potential is so small that its power output cannot meet consumption peaks, you may have no alternative but to use storage batteries.

Remember that the site's available head and flow rate are the major factors that limit the size of the installation, and economics dictate the size of the development of any hydropower site.

If the site has a flow of less than 1 lps or head that is less than 1 m, it may be best to consider an alternative power source because it may not be able to provide you with sufficient power. However, if you have a site with sufficient flow and head, you have the option of investing in a system that will supply your entire electrical power requirement and may be able to meet your peak demand. If there are other residential homes or lodges near your site that need electricity, you may consider sizing the system to take into account the option of selling surplus power. If you are a lodge owner, it may be very attractive to use electrical power to meet as many of your energy needs as possible and reduce your dependency on fossil-fuel-based generators.

For a typical residential home in a town or city, the total energy requirement is approximately 10 000 kWh per year. For an off-grid home, it could be much lower because people who live off-grid tend to conserve energy. In theory, you could supply all your electrical energy needs for lighting and appliances with a battery-based system of less than 1 kW, which will generate 8760 kWh of energy per year, assuming a 100 percent capacity factor. If the water-heating load were also included, the energy requirement would easily exceed 13 000 kWh per year. A 2-kW system may meet your needs, provided that the peak load will not be more than 2 kW. Assuming a capacity factor of 70 percent, this will produce approximately 12 260 kWh of energy per year. If you do not wish to include battery storage, you may need a system in the range of 3 to 5 kW. There are systems that generate 200 to 400 W, which, when coupled with good inverters, are found to be satisfactory for many off-grid residents. However, you still need to have a good load-management system to ensure that peak demand is kept below the maximum generation capacity of the system (see Case Study 1 in Section 4.1).

For a small community and for lodges, depending on the number of cabins and energy needs, you may plan for a larger system that has a capacity range of 15 to 30 kW. A well-designed system has the potential to entirely replace the need for a



fuel-based system for electrical generation. Even if it does not replace the use of propane for cooking and heating, burning propane for heat is much more effective than using it to run a generator.

The cost of a micro-hydropower system is largely related to the peak demand it supplies. Therefore, it is important to reduce your peak electricity requirement to keep your system costs down. However, if the output power potential of your site is greater than the demand, you may have surplus power for other uses, such as space heating or selling power to your neighbours. You may choose to build a smaller system to meet only your needs; at sites where it is possible to produce more than sufficient power, this will obviously be an important decision. Determining appropriate sizing requires substantial effort. The engineering and hydrology studies will determine the range of feasible options. It bears repeating that saving energy is always cheaper than producing more power.

## 2.7 Environmental Issues and Approvals

Water is a Crown-owned resource in Canada, and provincial and territorial ministries of natural resources manage its use. A water licence must be obtained from the provincial/territorial authority before the water can be used, even for non-consumptive uses such as a micro-hydropower system.

It is illegal to take surface water from a stream without first obtaining a water licence or other approval. It is not an offence to use unrecorded water for domestic needs, mineral prospecting or firefighting. Unrecorded water is water in a stream that is neither licensed nor reserved for other purposes but that is conserved for environmental reasons such as fish habitat and aquatic requirements.

Before you invest time and money in a hydropower system, find out if any regulatory issues need to be resolved. There can be institutional and legal considerations when installing a micro-hydropower system, and your project will proceed more smoothly if any regulatory problems are identified early on. It can take some time to obtain permits and licences.

First, contact your provincial or territorial government offices that deal with land and water in order to determine what local permits are needed for your area. The appropriate ministry of natural resources can indicate what is required and guide you on how to conduct the assessment and/or proceed with the submission. The assessment will depend on the nature and scale of your proposed project, and in some cases it can be as brief as two or three pages. All local permits or requirements must be satisfied before a federal hydropower licence will be issued, if required.

Permits and approvals that you will need when constructing a micro-hydropower system include environmental approvals (provincial/territorial and federal), an agreement regarding the use of water (provincial/territorial), an operating agreement (provincial/territorial), land lease agreements (provincial/territorial), permits for the use of navigable waters (federal) and building permits (provincial/territorial). Under the *Canadian Environmental Assessment Act*, an environmental impact assessment is required if the project receives federal funding or if it involves federal land and is considered by the approving agency to have a potentially significant environmental impact. It is unlikely, however, that you will need any federal permits for the capacity of systems covered in this guide. Installing a generating facility on the developer's property should present few problems. The water licence is issued on a first-come, first-served basis, and the amount of water you can divert for power generation is regulated at the time of issuing the licence. There may be conditions; for example, it may be required that 10 percent of



**Figure 10.** Intake of micro-hydropower system in Seaton Creek, British Columbia (photo courtesy of Homestead Hydro Systems)

mean annual discharge be flowing in the stream or river at all times. Fisheries and Oceans Canada has an interest in fish and fish habitats where there is cross-border migration such as with salmon.

Applications can take one to two or even three years to process. Owners can begin work on a system while waiting for a licence only when the system will be used solely for domestic purposes. Water-power projects require a water licence under the *Canada Water Act*.

In British Columbia, for example, Land and Water British Columbia Inc. is the one-stop access point for all of that province's government requirements for use of land and water. Approval under British Columbia's *Land Act* is required for any project component situated on Crown land, including the powerhouse, roads and transmission lines. Land and Water British Columbia Inc. reviews water-power projects of less than 50-MW capacity in British Columbia. Note that each province and territory has its own legislation.

Water licences for hydropower projects are generally issued for three categories: residential, commercial and general. The residential category applies to projects that have a capacity of 25 kW or less (in British Columbia), where the power is used to meet the household requirement of the licensee. The commercial category applies where the power is sold to immediate family members, employees or tenants of the licensee and the project capacity does not exceed 499 kW, or where the project supplies power to an industrial facility in which the licensee has an interest of more than 50 percent.

The general category applies to projects where the capacity exceeds the licensee's household and commercial needs and includes projects that sell energy to the provincial/territorial power grid. Annual water rental fees for hydro projects depend on the category of the power use (residential, commercial or general), the capacity of the system and the actual annual energy output of the system.

Another permit will be required from your local electrical safety authority in order to install the generator, control panels and all other electrical equipment, and these must comply with the *Canadian Electrical Code*. All electrical equipment must be approved and certified by CSA International.

The lead time for the construction of a micro-hydro project from the time of the original enquiry is about one to two years. Approval for small systems, especially using existing pipes, can be much faster. You may decide to follow up on everything yourself but, depending on the situation, it might be helpful to hire a professional consultant to speed up the process. The approval process is important: it is a search for an acceptable approach that gives the optimum use of a stretch of river or stream. We all want to protect the environment and to make the best use of our natural resources. For more information, contact your nearest provincial or territorial regional offices of the appropriate ministry that deals with land and water related to water-power projects. You can also visit their Web sites.

### 3.0 Basic Components of a Micro-Hydropower System

Basic components of a typical micro-hydro system are as follows:

- civil works components (headwork, intake, gravel trap with spillway, headrace canal, forebay and desilting basin, penstock pipe, powerhouse and tailrace)
- powerhouse components (turbines, generators, drive systems and controllers)
- transmission/distribution network

#### 3.1 Civil Works Components

Civil works structures control the water that runs through a micro-hydropower system, and conveyances are a large part of the project work. It is important that civil structures are located in suitable sites and designed for optimum performance and stability. Other factors should be considered in order to reduce cost and ensure a reliable system, including the use of appropriate technology, the best use of local materials and local labour, selection of cost-effective and environmentally friendly structures, landslide-area treatment and drainage-area treatment.



**Figure 11.** An intake weir for a 7-kW system (photo courtesy of Thompson and Howe Energy Systems Inc.)

#### Headworks

Headworks consist of the weir (see Figure 11), the water intake and protection works at the intake to safely divert water to the headrace canal. At some sites you may be able to install the penstock directly in the intake, with no need for a canal.



**Figure 12.** Intake for a 2-kW micro-hydropower system (photo courtesy of Homestead Hydro Systems)

#### Intake

The intake (see Figure 12) conveys the required flow of water from the source stream and diverts it into the headrace of the micro-hydropower system. It is designed and located precisely to ensure that the full design-flow rate goes to the turbine. Because many micro-hydropower systems are run-of-river systems, a low-head dam or weir could be used to hold back the water in order to provide a steadier flow of water, depending on the site.

#### Gravel Trap With Spillway

The gravel trap and screen are constructed close to the intake in order to prevent debris, gravel and sand from getting into the penstock. Gravel traps often have a mechanism to divert excess water back to the river and to flush sediments back to the river downstream of the intake. The spillway is designed to handle floodwater and protects the intake during heavy floods.

### **Headrace Canal**

The headrace canal carries the design flow from the intake to the forebay. Generally, the canal runs parallel to the river at an ever-increasing difference in elevation, which gives the micro-hydropower system its head. The canal cross section and alignment should be designed for optimum performance and economy in order to reduce losses due to leakage. You could use an open channel or pipeline to transport the water into the forebay.

### **Forebay and Desilting Basin**

The desilting basin is designed to settle suspended silt and flush the basin. The forebay tank connects the channel and the penstock. The tank allows fine silt particles to settle before the water enters the penstock. A fine trash rack is used to cover the intake of the penstock to prevent debris and ice from entering and damaging the turbine and valves.



**Figure 13.** Wooden screen for a 24-kW micro-hydropower system (photo courtesy of Thompson and Howe Energy Systems Inc.)

### **Penstock Pipe**

The penstock pipe transports water under pressure from the forebay tank to the turbine, where the potential energy of the water is converted into kinetic energy in order to rotate the turbine.

The penstock is often the most expensive item in the project budget – as much as 40 percent is not uncommon in high-head installations. It is therefore worthwhile to optimize its design in order to minimize its cost. The choice of size and type of penstock depends on several factors that are explained briefly in this section. Basically, the trade-off is between head loss and capital cost.

Head loss due to friction in the penstock pipe depends principally on the velocity of the water, the roughness of the pipe wall and the length and diameter of the pipe. The losses decrease substantially with increased pipe diameter. Conversely, pipe costs increase steeply with diameter. Therefore, a compromise between cost and performance is required. The design philosophy is to first identify available pipe options, select a target head loss of 5 to 10 percent or less of the gross head, and keep the length as short as possible. Several options for sizes and types of materials may need to be calculated and evaluated in order to find a suitable penstock pipe. A smaller penstock may save on capital costs, but the extra head loss may account for lost energy and revenue from generated electricity (if you are selling the power). In smaller systems, the allowable head loss can be as much as 33 percent. This is particularly relevant to developers who combine domestic water supply and penstock in the same pipe.

Several factors should be considered when deciding which material to use for a particular penstock: design pressure, the roughness of the pipe's interior surface, method of joining, weight and ease of installation, accessibility to the site, design life and maintenance, weather conditions, availability, relative cost and likelihood of structural damage. The pressure rating of the penstock is critical because the pipe wall must be thick enough to withstand the maximum water pressure; otherwise there will be a risk of bursting. The pressure of the water in the penstock depends on the head; the higher the head, the higher the pressure. Pressure ratings are normally given in bar units or PSI; 10.2 m of head will exert a pressure of 1 bar, or 14.5 PSI. The penstock becomes more expensive as the pressure rating increases.



**Figure 14.** High-density polyethylene (HDPE) penstock being buried in a steep hill (photo courtesy of Thompson and Howe Energy Systems Inc.)



**Figure 15.** Double 10-cm (4-in.) HDPE penstock pipe for an 8-kW system

The most commonly used materials for a penstock are HDPE, uPVC and mild steel because of their suitability, availability and affordability. Layout of the penstock pipelines depends on their material, the nature of the terrain and environmental considerations; they are generally surface-mounted or buried underground. Special attention is necessary where a penstock is installed in a very cold environment; protection from ice and frost must be considered. In severe frost areas, penstocks should

always be buried below the frost line. Where freezing is not a concern, the penstock may be left above ground. However, it is generally preferable to bury the penstock to provide protection from expansion, animals and falling trees. Because of changes in the ambient temperature, the length of the penstock pipe may be subjected to expansion and contraction. Expansion joints are used to compensate for maximum possible changes in length.

**Table 3. Comparison of Penstock Materials<sup>1</sup>**

Material	Friction	Weight	Corrosion	Cost	Jointing	Pressure
Mild Steel	★★★	★★★	★★★	★★★★	★★★★	★★★★★
HDPE <sup>2</sup>	★★★★★	★★★★★	★★★★★	★★	★★	★★★★★
uPVC <sup>3</sup>	★★★★★	★★★★★	★★★★	★★★★	★★★★	★★★★★

<sup>1</sup> Adapted from Fraenkel, Peter, et al. *Micro-Hydro Power: A Guide for Development Workers*. London, U.K.: Intermediate Technology Publications in association with the Stockholm Environment Institute, 1991.

★ = Poor —————▶ ★★★★★ = Excellent

<sup>2</sup> HDPE = High-density polyethylene

<sup>3</sup> uPVC = Unplastified polyvinyl chloride

### Powerhouse and Tailrace

The powerhouse (see Figure 16) is a building that houses the turbine, generator and controller units. Although the powerhouse can be a simple structure, its foundation must be solid. The tailrace is a channel that allows the water to flow back to the stream after it has passed through the turbine.



**Figure 16.** Powerhouse for an 8-kW system (photo courtesy of Thompson and Howe Energy Systems Inc.)

## 3.2 Powerhouse Components

### Turbines

A turbine unit consists of a runner connected to a shaft that converts the potential energy in falling water into mechanical or shaft power. The turbine is connected either directly to the generator or is

connected by means of gears or belts and pulleys, depending on the speed required for the generator (see Section 3.3 for information on drive systems). The choice of turbine depends mainly on the head and the design flow for the proposed micro-hydropower installation. The selection also depends on the desired running speed of the generator. Other considerations such as whether the turbine is expected to produce power under part-flow conditions also play an important role in choosing a turbine. Part-flow is where the water flow is less than the design flow. All turbines tend to run most efficiently at a particular combination of speed, head and flow. In order to suit a variety of head and flow conditions, turbines are broadly divided into four groups (high, medium, low and ultra-low head) and into two categories (impulse and reaction).

Pelton and Turgo turbines are the most commonly used impulse-type turbines in micro-hydropower systems in Canada. These turbines are simple to manufacture, are relatively cheap and have good efficiency and reliability. To adjust for variations in stream flow, water flow to these turbines is easily controlled by changing nozzle sizes or by using adjustable nozzles. Pelton turbines are used for sites that have low flows and high heads.

Most small reaction turbines are not easy to adjust to accommodate for variable water flow, and those that are adjustable are expensive because of these units' variable guide vanes and blades. An advantage of reaction turbines is that they can use a site's full available head. This is possible because the draft tube used with the turbine recovers some of the pressure head after the water exits the turbine. Some of this type of turbine are now being manufactured that can generate power at head as low as 1 m (3 ft.).

**Table 4.** Groups of Water Turbines

Turbine Runner	High Head (more than 100 m / 325 ft.)	Medium Head (20 to 100 m / 60 to 325 ft.)	Low Head (5 to 20 m / 16 to 60 ft.)	Ultra-Low Head (less than 5 m / 16 ft.)
Impulse	Pelton Turgo	Cross-flow Turgo Multi-jet Pelton	Cross-flow Multi-jet Turgo	Water wheel
Reaction	—	Francis Pump-as-turbine	Propeller Kaplan	Propeller Kaplan

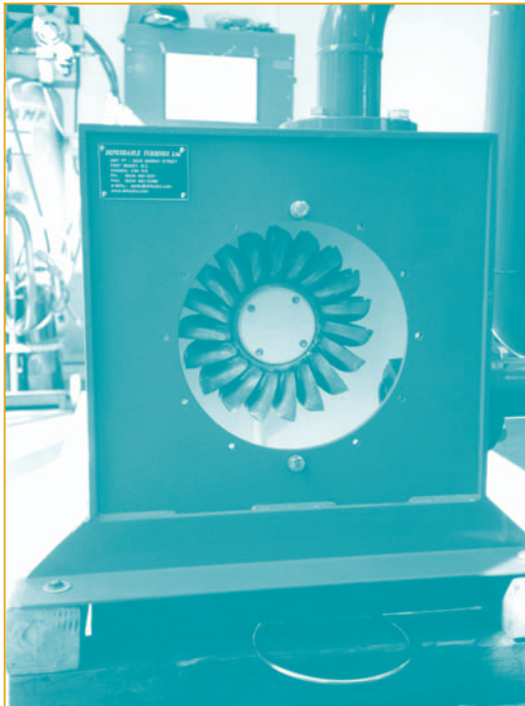

**Figure 17.** A 20-cm (8-in.) pitch diameter Pelton turbine runner (photo courtesy of Thompson and Howe Energy Systems Inc.)

### **Pump-as-Turbine**

For a number of years there has been wide interest in reverse-engineered conventional pumps that can be used as hydraulic turbines. The action of a centrifugal pump operates like a water turbine when it is run in reverse. Because the pumps are mass-produced, they are more readily available and less expensive than turbines. It is estimated that the cost of a pump-as-turbine (PAT) is at least 50 percent less or even lower than that of a comparable turbine. However, for adequate performance, a micro-hydropower site must have a fairly constant head and flow because PATs have very poor partial-flow efficiency. It is possible to obtain full efficiency from PATs by installing multiple units, where they can be turned on or off depending on the availability of water in the stream. PATs are most efficient in the range of 13 to 75 m (40 to 250 ft.) of gross head. The higher the head, the less expensive the cost per kilowatt; this is generally the case with all turbines.

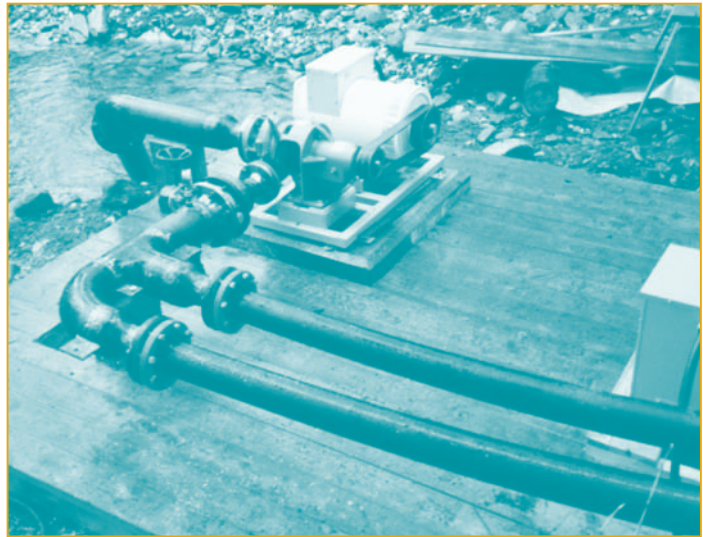

**Figure 18.** Pump-as-turbine with 12-kW output using twin 10-cm (4-in.) penstock (photo courtesy of Thompson and Howe Energy Systems Inc.)

### **Water Wheels**

Water wheels are the traditional means of converting useful energy from flowing and falling water into mechanical power. Although not as efficient as turbines, they are still a viable option for producing electricity for domestic purposes. They are simple to control, lend themselves to do-it-yourself projects and are aesthetically pleasing. There are three basic types of water wheels: undershot, breastshot and overshot. Variations are Poncelet and pitchback types. The major disadvantage is that they run relatively slowly and require a high-ratio gearbox or other means of increasing the speed if they are to drive a generator. However, for low power – for example, less than 5 kW and heads less than 3 m (10 ft.) – they are worth considering. In most parts of Canada, however, water wheels are generally not recommended for winter operation because it is almost impossible to prevent freezing and ice buildup, which could damage the wheel.

### Turbine Efficiency

Typical efficiency ranges of turbines and water wheels are given in Table 5. For more precise figures, contact turbine manufacturers. Turbines are chosen or are sometimes tailor-made according to site conditions. Selecting the right turbine is one of the most important parts of designing a micro-hydropower system, and the skills of an engineer are needed in order to choose the most effective turbine for a site, taking into consideration cost, variations in head, variations in flow, the amount of sediment in the water and overall reliability of the turbine.

**Table 5. Typical Efficiency of Turbines and Water Wheels**

Prime Mover	Efficiency Range
<b>Impulse turbines:</b>	
Pelton	80–90%
Turgo	80–95%
Cross-flow	65–85%
<b>Reaction turbines:</b>	
Francis	80–90%
Pump-as-turbine	60–90%
Propeller	80–95%
Kaplan	80–90%
<b>Water wheels:</b>	
Undershot	25–45%
Breastshot	35–65%
Overshot	60–75%

### Generators

Generators convert the mechanical (rotational) energy produced by the turbine to electrical energy; this is the heart of any hydroelectrical power system. The principle of generator operation is quite simple: when a coil of wire is moved past a magnetic field, a voltage is induced in the wire.

Alternating current (AC) generators are also referred to as alternators. They generate varying voltages, which alternate above and below the zero voltage point. It is this process that produces AC electricity. This same principle is used in all electric generators, from large hydro and nuclear plants to the alternator in your car, although the speed will vary depending on the type of generator used.

There are two types of generators: synchronous and asynchronous. Synchronous generators (see Figure 19) are standard in electrical power generation and are used in most power plants. Asynchronous generators are more commonly known as induction generators. Both of these generators are available in three-phase or single-phase systems. System capacity, type of load and length of the transmission/distribution network dictate whether a single- or three-phase generator should be used.

Induction generators are generally appropriate for smaller systems. They have the advantage of being rugged and cheaper than synchronous generators. The induction generator is a standard three-phase induction motor, wired to operate as a generator. Capacitors are used for excitation and are popular for smaller systems that generate less than 10 to 15 kW.

All generators must be driven at a constant speed to generate steady power at the frequency of 60 Hz. The number of poles in the generator determines the speed, commonly stated in revolutions per minute (rpm). The more pairs of poles, the slower the speed. The 2-pole generator with a speed of 3600 rpm is too high for practical use with a micro-hydropower system. The 1800-rpm 4-pole generator is the most commonly used. The cost of the generator is more or less inversely proportional to the speed; the lower the speed, the larger the frame size needs to be for equivalent power output. For this reason, generators that operate at less than 1200 rpm become costly and bulky. In order to match the speed of the generator to the low speed of the turbine, a speed increaser such as belt and/or gearbox might be needed.



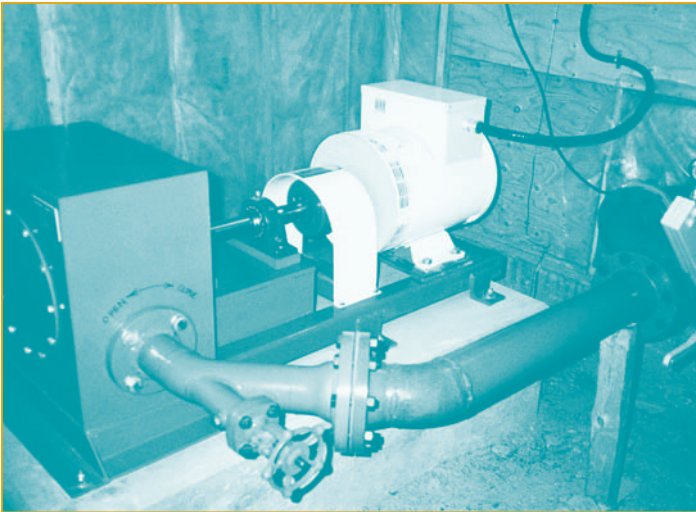

**Figure 19.** A directly coupled Pelton turbine with synchronous generator 8-kW system

Electrical power can be generated in either AC or direct current (DC). AC has the advantage of allowing the use of common household appliances and tools and is much more economical for transmitting power to homes. DC current can be used in two ways – either directly as DC or converted to AC through the use of an inverter. The main advantage of DC is ease of battery storage. For DC systems, which are described in more detail in Section 4.1, specially designed DC generators are used.

### Generator Efficiency

Full-load efficiencies of synchronous generators vary from 75 to 90 percent, depending on the size of the generator. Larger generators are more efficient, and three-phase generators are generally more efficient than single-phase ones. The efficiency will be reduced by a few percentage points when being used at part load (e.g., at 50 percent of the load). Efficiency of induction generators is approximately 75 percent at full load and decreases to as low as 65 percent at part load. Permanent magnet DC generators have efficiencies of more than 80 percent at full load. It is crucial to take these figures into account when selecting a generator because the overall efficiency of the system will be affected.

There are other factors to consider when selecting a generator for your system, such as capacity of the system, types of loads, availability of spare parts, voltage regulation and cost. If high portions of the loads are likely to be inductive loads, such as motor and fluorescent lights, a synchronous generator will be better than an induction generator. Induction generators in stand-alone application mode cannot supply the high-surge power required by motor loads during start-up. Selecting and sizing the generator is very technical, and an energy expert should make the selection during the feasibility study.

### 3.3 Drive Systems

In order to generate electrical power at a stable voltage and frequency, the drive system needs to transmit power from the turbine to the generator shaft in the required direction and at the required speed. Typical drive systems in micro-hydropower systems are as follows:

- **Direct drive:** A direct drive system is one in which the turbine shaft is connected directly to the generator shaft. Direct drive systems are used only for cases where the shaft speed of the generator shaft and the speed of the turbine are compatible. The advantages of this type of system are low maintenance, high efficiency and low cost.
- **“V” or wedge belts and pulleys:** This is the most common choice for micro-hydropower systems. Belts for this type of system are widely available because they are used extensively in all kinds of small industrial machinery.
- **Timing belt and sprocket pulley:** These drives are common on vehicle camshaft drives and use toothed belts and pulleys. They are efficient and clean-running and are especially worth considering for use in very small system drives (less than 3 kW) where efficiency is critical.
- **Gearbox:** Gearboxes are suitable for use with larger machines when belt drives would be too cumbersome and inefficient. Gearboxes have problems regarding specification, alignment, maintenance and cost, and this rules them out for micro-hydropower systems except where they are specified as part of a turbine-generator set.

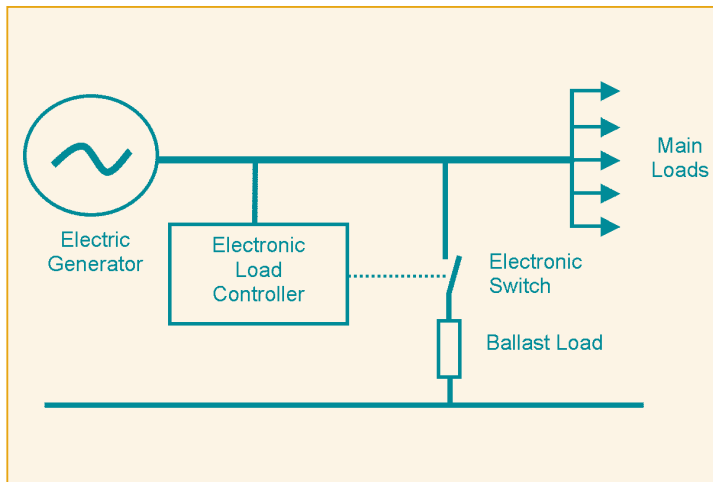

**Figure 20.** Single-line diagram of generator, electronic load controller and main loads

### 3.4 Electronic Load Controllers

Water turbines, like petrol or diesel engines, will vary in speed as load is applied or disconnected. Although not a great problem with machinery that uses direct shaft power, this speed variation will seriously affect the frequency and voltage output from a generator. It could damage the generator by overloading it because of high power demand or over-speeding under light or no-load conditions. Traditionally, complex and costly hydraulic or mechanical speed governors similar to larger hydro systems have been used to regulate the water flow into the turbine as the load demand varied. Over the last two decades, electronic load controllers (ELCs) have been developed that have increased the simplicity and reliability of modern micro-hydropower systems.

An ELC is a solid-state electronic device designed to regulate output power of a micro-hydropower system. Maintaining a near-constant load on the turbine generates stable voltage and frequency. The controller compensates for variation in the main load by automatically varying the amount of power dissipated in a resistive load, generally known as the ballast or dump load, in order to keep the total load on the generator and turbine constant. Water heaters are generally used as ballast loads. An ELC constantly senses and regulates the generated frequency. The frequency is directly proportional to the speed of the turbine.

Voltage control is not required for synchronous generators because they have a built-in automatic voltage regulator. Without an ELC, the frequency will vary as the load changes and, under no-load conditions, will be much higher than rated frequency. ELCs react so fast to load changes that speed changes are not even noticeable unless a very large load is applied. The major benefit of ELCs is that they have no moving parts, are reliable and are virtually maintenance-free. The advent of ELCs has allowed the introduction of simple and efficient multi-jet turbines for micro-hydropower systems that are no longer burdened by expensive hydraulic governors.

ELCs can also be used as a load-management system by assigning a predetermined prioritized secondary load, such as water heating, space heating or other loads. In this way, you can use the available power rather than dumping it into the ballast load. It can be used to connect loads by priority sequence and can thus control loads that total four to five times the actual output of the micro-hydropower system. (See Section 2.4 for information on load management.)

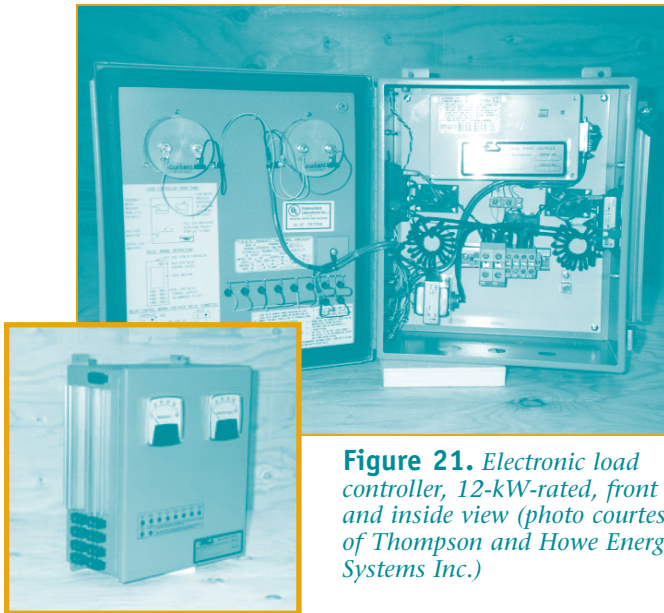

**Figure 21.** *Electronic load controller, 12-kW-rated, front and inside view (photo courtesy of Thompson and Howe Energy Systems Inc.)*

There are various types of ELCs on the market that can regulate systems from as small as 1 kW to 100 kW. The choice of the controller depends on the type of generator you have. ELCs are suitable for synchronous generators. If you have an induction generator, you will need an induction generator controller (IGC). IGCs work on a principle that is similar to that used by ELCs, but an IGC monitors the generated voltage and diverts the surplus power to the ballast load.

Other types of controllers are being introduced to the market that are based on similar principles that may be suitable for your application. For example, distributed intelligent load controllers (DILCs) distribute the electric power to various loads within the home or the distribution system. DILCs are fitted directly to appliances for refrigeration, space heating or water heating in prioritized sequence. They sense the frequency and the voltage of the generating system and switch the loads accordingly, without the risk of overloading the generating system. DILCs can be used with other controllers such as the ELC and IGC as part of the load management solution or can be used to displace those controllers altogether.

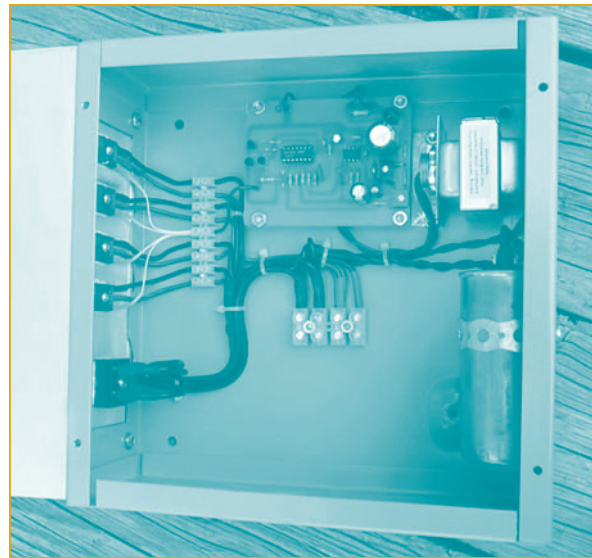

**Figure 22.** *Induction generator controller, 3-kW rated (photo courtesy of Homestead Hydro Systems)*

Be aware that these controllers can cause some radio frequency interference. These controllers are usually supplied in weatherproof cabinets that also contain the electrical meters, safety protection devices and switchgear and all connections for power cables.

### 3.5 Transmission/Distribution Network

The most common way of transporting electricity from the powerhouse to homes is via overhead lines. The size and type of electric conductor cables required depends on the amount of electrical power to be transmitted and the length of the power line to the home. For most micro-hydropower systems, power lines would be single-phase systems. For larger systems, the voltage may need to be stepped up using a transformer or a standard three-phase system in order to reduce transmission losses. Depending on the environment and geographical conditions, you may even need to consider an underground power line, which generally costs considerably more than overhead lines but may be safer. All electrical works must follow national and local electrical codes and should be undertaken only by qualified and certified professionals.

## 4.0 Choosing a System

The type of micro-hydropower system you choose will depend on the capacity you need, the anticipated power demand and the profile of your site. A major consideration is whether the site is a remote stand-alone or grid-connected system.

This section briefly describes the types of systems that are available. For remote sites, there are generally two types of micro-hydropower systems: battery-based and AC-direct. For grid connection only, AC-direct systems are appropriate, but there are other issues that should be considered. More information can be obtained from manufacturers and suppliers.

### 4.1 Battery-Based Systems

If the micro-hydropower system is not able to generate sufficient power to meet the peak load requirement, batteries are used to store electricity for use at night and/or for meeting loads during the day. If your power requirement is for lighting and to run some efficient appliances, battery-based systems may be suitable. These systems use deep-cycle



**Figure 23.** A 1-kW rated low-head battery-based system (photo courtesy of Energy Systems & Design)

batteries that are designed to gradually discharge and charge 50 percent of their capacity hundreds of times. There are many off-grid homes that use battery-based systems, including those that use solar and wind-power systems. The advantage of battery-based systems is that they require far less water flow than AC-direct systems, they are usually less expensive, and they use the maximum energy available from your system.

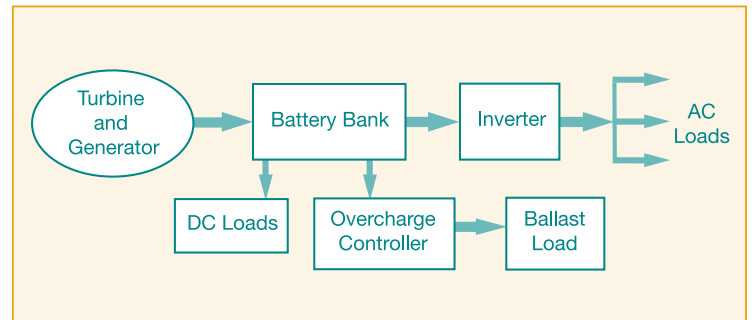

**Figure 24.** Balance of system for a battery-based system

Several specialized companies offer their own designs at competitive rates. Shop around until you find a system that suits your needs and budget. These systems are small, the turbine and generator are usually integrated into one unit, they are easy to install, and they have developed a good reputation for reliability over the years. One advantage to keep in mind is that a system that has energy stored in batteries can also provide peak power that is many times greater than the installed system. For example, a 400-W system charging the battery bank can provide peak power as high as 5 kW or more with appropriate inverters, so it could be useful in meeting a short-term peak load. Used batteries should be recycled or disposed of as hazardous waste in order to minimize environmental impacts.

Equipment for this type of system is available in a range of voltages of 12, 24, 36, 48, 120 or 240 DC. The choice of generating voltage is dictated by the capacity of the system and the distance that the electrical power needs to be transmitted. The longer the distance, the higher the voltage you will need in order to reduce transmission losses. An inverter is used to invert DC voltage into standard AC supply voltage to power AC appliances. You can also use DC-powered appliances that are powered directly from the battery.

Battery-based micro-hydropower systems are available from as small as 100 W to about 1600 W. Table 6 lists the various types of systems available.

Water current turbines convert the kinetic energy of moving water and can be used in rivers and streams that have a high volume of water and that are slow-moving. These turbines are different from conventional hydropower turbines that harness the potential energy available in a head difference of the water flow.

**Table 6. Battery-Based Micro-Hydropower Systems**

System	Power Output (W)	Head (m) Minimum/Maximum	Flow (lps) Minimum/Maximum	Voltage (Vdc*)	Type of Turbine and Generator
Ultra-low head	100–1000	1/3	30/65 lps	12/24/48/120	Propeller; permanent magnet DC generator
Low and medium head	50–1600	3/60	0.6/10 lps	12/24/48/120	Turgo; permanent magnet DC generator
High head	100–1500	6/180	0.25/16 lps	12/48	Pelton; permanent magnet DC generator
Water current	100	Water flow	0.25 m/s	12/24	Propeller; submersible generator

\*Direct current voltage

**Case Study 1:  
200-Watt Micro-Hydropower System  
in Lillooet, British Columbia**

*(Information provided by Scott Davis, Yalakom Appropriate Technology, British Columbia)*

Micro-hydropower systems do not need to be elaborate in order to give good service. In 1997, the owner of a homestead west of Lillooet, British Columbia, brought electrical power to his household with a simple system. A couple of hundred yards (180 m) of 2-inch (5-cm) polyethylene pipe was unreeled in the mountain stream that flowed near the house. Although not all streams may be suitable for this kind of arrangement, this particular system has resisted months of sub-zero temperatures and has worked well year-round over the last few years.

With a net pressure of about 15 pounds per square inch (PSI), this system has about 10.5 m (35 ft.) of head; a permanent magnet generator unit generates about 200 W at 24 V of continuous

power from 6 lps (100 gpm) of water flow. The power is transmitted about 60 m (200 ft.) to a 900 amp-hour deep-cycle battery bank and 2.5-kW-rated inverter. Installation took about four days.



**Figure 25.** A 200-W micro-hydropower system in action (photo courtesy of Scott Davis, Yalakom Appropriate Technology, British Columbia)

This system provides the owner with a level of power consumption that is close to the European average of 200 to 300 kWh per month, as opposed to the Canadian average of 850 to 1000 kWh per month. It brings generous amounts of energy for efficient lighting, electronics such a VCR and stereo, numerous shop tools and an electric refrigerator and freezer to this remote area for the first time.

By using other technologies such as wood burning for space heating and propane for cooking, this system provides a high level of clean, renewable energy without extensive civil works. Required maintenance has been limited to cleaning the intake. This system could be replaced today for about \$7,500.

**Table 7. Integrated Micro-Hydropower Systems**

System	Power Output (W)	Head (m) Minimum/Maximum	Flow (lps) Minimum/Maximum	Voltage (V)	Type of Turbine and Generator
Ultra-low head	200–1 000	1.5 (maximum)	35/130	110	Propeller; permanent magnet AC generator
Low head	300–5 000	2/5	28/120	110	Propeller; induction generator
Medium head	200–500	5/12	6/10	110	Turgo; permanent magnet AC generator
Medium head	600–2 000	8/17	20/30	110	Turgo; induction generator
Medium head	300–5 500	12/34	5/28	110	Pelton; induction generator
Medium head	5 000–8 000	24/34	33/40	110	Turgo; synchronous generator
Medium head	9 000–16 000	24/34	66/80	110	Turgo; synchronous generator
High head	1 500–5 000	20/90	8/30	110	Turgo; synchronous or induction generator

## 4.2 AC-Direct Systems

AC-direct systems are similar to those used by utilities to power our homes in towns and cities. A micro-hydropower AC-direct system does not have battery storage, so the system is designed to supply the load directly. This system is appropriate for grid-connected sites and for remote stand-alone sites.

The AC-direct systems listed in Table 7 are available off-the-shelf, are fully integrated for “water to wire” installation and are generally much more economical than custom-made designs. There are larger integrated systems available for low-head applications.



**Figure 26.** A double-jet Turgo induction generator system, 5-kW rated

The smallest fully integrated system available is a 200-W unit, which can work with a head as low as 1 m (3 ft.). Many larger units are manufactured

and assembled according to the site profile's requirements and the generating capacity needed. (See Section 3.2 for descriptions of turbines.)

### Case Study 2:

#### Remote 10-kW Micro-Hydropower System

*(Information provided by Scott Davis, Yalakom Appropriate Technology, British Columbia)*

Despite the presence of high-tension power lines along the Lillooet River valley in southwestern British Columbia, First Nations settlements along this river have never been connected to the utility grid.

Water from countless streams falls thousands of feet from the mountains to the valley floor. The Peters family lives on a small piece of reserve land, about three kilometres from the village of Skookumchuck. In the past, diesel generators met the Peters' electrical needs, but over the years it proved to be expensive and difficult to operate.

There are two streams on the Peters' property that are well suited for a micro-hydropower system, but it was the one that is larger and closer to the house that the Peters' chose. The site is steep and rocky and has about 90 m (300 ft.) of head above the house. Construction took place over a few months. A small settling basin was dug beside the creek. It took a day of an excavator's time to dig the penstock, and a crew installed the 275 m (900 ft.) of 10-cm (4-in.) pipe in a few days. The intake, thrust block and the powerhouse also took some time to complete.

The system uses a direct-coupled Pelton turbine that drives a 12-kW alternator. It features a flywheel for improved surge capacity and has an adjustable needle nozzle to provide efficient operation at a wide range of flows. It usually produces about 10 kW from a flow rate of 22 lps (350 gpm). It can use much less water and still provide good service for the two households that are now using the power.

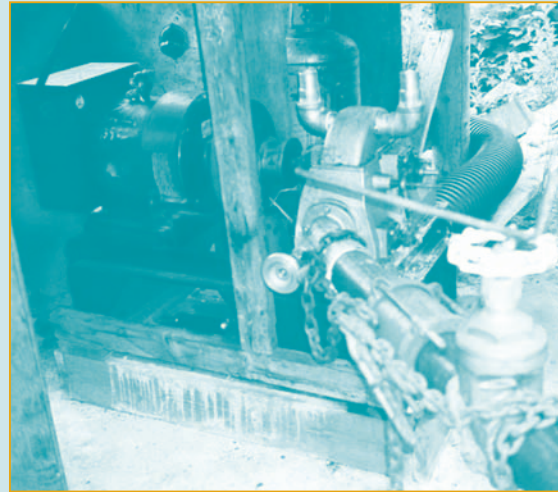

**Figure 27.** A 10-kW micro-hydropower system in action (photo courtesy of Scott Davis, Yalakom Appropriate Technology, British Columbia)

The system, which is governed by a Canadian-designed electronic load controller, provides generous amounts of electricity for lights and appliances, and it operates a well pump that the diesel unit could not. It provides year-round electric-heated hot water for two households and significant space heating in the winter. Propane is used for cooking.

The system requires little maintenance other than occasionally cleaning the intake and greasing the bearings. A submerged intake with a stainless steel screen has proven satisfactory for several years. The system has run well since it was commissioned in 1998. Replacing this system today would cost about \$25,000 in addition to labour costs.

### 4.3 Grid-Connected Systems

There is no reason you cannot install a system near or where you already have a grid supply and obtain electrical power from both your micro-hydropower system and the grid. You may even be able to offset your electric bill by supplying the surplus power to the grid at the same time through net-metering, also known as net-billing. If you want to sell your power to the utility or to your neighbours, there are a few regulations and approvals that must be met.

#### ***Net-Metering***

Net-metering allows a small power producer – such as a residence or farm with a micro-hydropower, wind turbine or photovoltaic system – to connect to the power grid to offset the purchase of electrical energy from the utility with the surplus energy generated by the on-site generating facility. Net-metering does away with the need to install costly backup generators or batteries to supplement a small renewable system. A single meter measures the electricity purchased from the utility and turns backward when the small power producer feeds electricity into the grid. The net-meter measurement determines the amount of electricity charged to the user.

Net-metering programs are in various stages of development in British Columbia, Alberta, Manitoba and Ontario. Each utility has its own policy for grid connections. For further information, contact the customer relations office of your local utility.

#### ***Hybrid System***

A hybrid system is where two or more generation sources, such as a micro-hydropower, wind or photovoltaic system or small petrol/diesel generator are combined to provide electrical power. Such a system offers several advantages over a single type of generation and can be set up depending on your power requirement. Because the peak operation times for wind and solar power occur at different times of the day and year, a hybrid system is more capable of producing power when you need it. Wind speeds are low in the summer when the sun shines the brightest and longest; winds are strong in the winter when there is less sunlight. If you also add a micro-hydropower system, you are likely to have a completely independent and reliable system because it can provide backup service that is quieter, more reliable and cheaper to operate than a diesel generator, even if water flow dries up in the summer.



## 5.0 Economics

How much will a micro-hydropower system cost? There is no standard answer to this question because costs depend on site conditions and on how much work you are prepared to do yourself. In general, with current technologies the total cost can range from \$1,500 to \$2,500 per kilowatt of installed capacity, depending on the system's capacity and location. For systems that are less than 5 kW in power output, the cost per kW is approximately \$2,500 or higher because of the smaller size and the cost of additional components such as a battery bank and inverter.

Costs for developing a micro-hydropower system fall into two categories: initial and annual costs. Initial costs are those that occur at the beginning of the project before any electricity is generated and include costs to carry out a feasibility study, purchase and install equipment and obtain permits. Recurring annual costs are for operating and maintenance. Generally, micro-hydropower systems have high initial costs but relatively low annual costs compared with traditional fossil-fuel-based sources. In fact, hydroelectric maintenance costs are the lowest of all energy-producing technologies. High-head, low-flow system costs are less than low-head, high-flow systems because all components of low-flow systems (e.g., penstock, turbine, intake and spillway) will be smaller. If some part of the system already exists (e.g., a dam or an intake), this will lower the total cost.

The cost of a system will vary depending on what kind of equipment is used, how much material and equipment are needed, the cost of civil works and other factors. If you hire a contractor to build an intake, a long headrace canal, powerhouse and tailrace, your cost will be higher than doing it yourself. Each hydro site is unique because about 75 percent of the development cost is determined by the location and site conditions. Only about 25 percent of the cost is relatively fixed, which is the cost of the electro-mechanical equipment.

### 5.1 Initial Costs

At this stage, you should have a good idea of the basic configuration of the kind of system you require. The best sources of information are manufacturers and suppliers. It is possible to obtain a complete system price for your proposed

installation. Remember to include all costs: calculate the intake, headrace, forebay, penstock, powerhouse and electro-mechanical equipment, including the turbine, the generator, controllers and the transmission/distribution network (see Appendix D).

If you do not own the land, you will have to add the cost of buying or leasing it. If you are leasing, this will fall under the category of annual costs. There are also "soft" costs to consider; these, depending on the size and complexity of the system, can add considerably to initial costs. Soft costs include pre-feasibility and feasibility studies, the water licence application, obtaining land rights and local permits, and transportation and construction. At some sites, the equipment may need to be transported by helicopter, which will increase costs and could be significant for remote locations. You should also include a small percentage of the initial costs for contingencies or for unforeseen costs. It is a good idea to obtain the services of an energy expert to make these calculations for you, and costs should be estimated at the time of the feasibility study. For smaller systems, you could list the components and obtain a quote by calling suppliers and checking catalogues and price lists.

**Table 8a. Approximate Micro-Hydropower System Costs: Battery-Based Systems**

Component	100 W (flow rate of 4 lps / 63 gpm; head at 5 m / 16 ft.)	400 W (flow rate of 4 lps / 63 gpm; head at 25 m / 80 ft.)
Penstock	\$650	\$1,000
Turbine-generator	\$2,500	\$2,500
Controller	\$400	\$400
Batteries	\$520	\$1,000
Inverter	\$1,200	\$3,000
Transmission line	\$500	\$500
Powerhouse	\$200	\$200
Miscellaneous	\$500	\$1,200
<b>Total cost of equipment</b>	<b>\$6,470</b>	<b>\$9,800</b>
Installations	Optional (\$2,000)	Optional (\$2,000)

Estimates provided by Energy Alternatives Ltd.

The estimated cost for 50-kW systems (see Table 8b) is based on using a pump-as-turbine system; the cost of the turbine will be much higher if a traditional turbine is used. The costs for civil works and

**Table 8b. Approximate Micro-Hydropower System Costs: AC-Direct Systems**

<b>Component</b>	<b>3.5 kW</b> (flow rate at 14 lps / 222 gpm; head at 50 m / 165 ft.)	<b>10 kW</b> (flow rate of 62 lps / 982 gpm; head at 32 m / 100 ft.)	<b>50 kW</b> (flow rate at 100 lps / 1585 gpm; head at 85 m / 280 ft.)
Penstock	\$1,600	\$3,500	\$24,000
Turbine-generator	\$3,300	\$6,000	\$9,500
Controller	\$1,900	\$3,600	\$5,400
Transmission line	\$1,500	\$3,500	\$7,500
Powerhouse	\$1,000	\$3,000	\$4,500
Miscellaneous	\$1,650	\$1,800	\$4,500
<b>Total cost of equipment</b>	<b>\$10,950</b>	<b>\$21,400</b>	<b>\$55,400</b>
Installations	\$2,000	\$4,500	\$10,500
<b>Total amount</b>	<b>\$12,950</b>	<b>\$25,900</b>	<b>\$65,900</b>
<b>Cost \$/kW</b>	<b>\$3,700</b>	<b>\$2,590</b>	<b>\$1,318</b>

Estimates provided by Thompson and Howe Energy Systems Inc.

permits are not included. All costs given in Tables 8a and 8b are approximate. Keep in mind that each micro-hydropower system is unique and that costs are site-specific.

## 5.2 Annual Costs

Although minimal for a hydropower system, the most important annual costs are for operation and maintenance. These costs include labour and materials for clearing the intake/trash rack, equipment servicing, spare parts, and general and transmission line maintenance. Others costs include land leases, property taxes, water rental and general administration. A contingency allowance should be included to account for unforeseen annual expenses. For a battery-based system, you should include the cost of replacing the batteries every 5 to 10 years, depending on the quality and cycling patterns anticipated.

## 5.3 Evaluating a System

Several things may need to be taken into account in order to evaluate whether a micro-hydropower system is right for you. If a site has sufficient flow rate and head to meet your power and energy requirements, the only other factor to consider is whether there are alternative energy sources that would be feasible and more economical. You may have options such as solar, wind or diesel-powered generators or even extending the local grid. If you do have such options, there are various ways to accurately compare the cost of generating energy from alternative sources.

One indicator of the cost of your system is that of dollars per installed kilowatt. To calculate this, divide the total initial cost by the system's capacity in kilowatts. A drawback of this approach is that it does not include operating costs and so does not realistically compare a micro-hydro system with

alternatives such as wind or diesel generation. A more accurate comparative indicator is the energy output cost in dollars per kilowatt hour. The unit cost of energy is calculated based on energy generated by the system over its lifetime. The “fuel” for micro-hydropower generation is almost free, and therefore the system becomes more effective if it runs most of the time because development costs are the same whether 50 or 100 percent of its potential power is used. The unit price of energy will be quite different depending on what percentage of potential power is generated.

Some of the commonly used financial analyses to evaluate a system and to compare the cost of energy from alternative sources are net present value (NPV) and simple payback. The NPV of project investment is the present value of future cash inflows minus the present (discounted) value of the investment and any future cash outflows (such as start-up and operating costs) over its lifetime. This analysis compares the value of money now with the value of money in the future after taking inflation and return into account. The NPV of a project that has positive value is attractive.

Simple payback is a measure of the number of years it would take to have your annual energy savings pay for the initial and annual costs of operating the micro-hydropower system, i.e., the length of time required to recover the cost of your investment.

These financial analyses are complex. They may involve issues such as the time value of money, life-cycle costing and tax savings. A thorough analysis may not be necessary for smaller systems, but as

the system gets larger, a full financial and economic analysis is valuable. If you need information on how to make the analysis, consult the bibliography at the end of this guide. Depending on the size and cost of the system, it may be better to ask an experienced professional to make this analysis.

The economics of a system will be significantly influenced by its technical design, hydrology, power and size. The value of the system is the future benefits it can provide or the costs that can be avoided. These costs are primarily associated with alternatives to the micro-hydropower system. In most cases, the alternatives will be diesel generation or connection to the local grid. In many remote locations, diesel-generated electricity may already be available. Therefore, the economic analysis becomes a comparison of the capital and operating costs of the micro-hydropower development against those associated with diesel generation or extending the local grid. (See Section 1.3 for other issues you may need to consider.)

In the event that your site has access to a local electricity grid, it may be difficult to justify a micro-hydropower system on economic terms unless you are prepared to take a long-range view. For some people, the idea of having a self-reliant and self-sufficient lifestyle is appealing, regardless of economic considerations. You should also investigate various government programs to learn about renewable energy sources that provide tax exemptions for material and equipment and to learn what financial incentives may be available.

## 6.0 Buying a Micro-Hydropower System

### 6.1 Expert Assistance

A micro-hydropower system is complex. Many factors need to be considered, including the technical design, approvals and economics. You will need to consult an energy expert to design and optimize a system for your site. The sizing of the turbines and penstock and selecting the type of generator is technical and beyond the scope of this guide, but experienced energy experts will be able to evaluate your power requirements and the features of your site and provide the most appropriate solution to meet your energy requirements.

Smaller systems in the range of 5 kW or less may not take as much design time as larger systems. Smaller systems are available as integrated units, and the manufacturer and supplier can provide information to select an optimum sized penstock pipe, turbine and generator. With this information in hand, you may be able to construct the civil works yourself. However, it is best to seek help if you are uncertain about any aspect of a micro-hydropower system or project.

For larger systems, designing and sizing each component is required for optimum operation and performance. Optimum design and sizing of civil works, the penstock, the turbine, the generator, the transmission/distribution network and load management is not only important for reliability; it is just as important in economic terms because the total cost of the system is directly affected. For systems that are larger than 5 kW, seek the services of an experienced energy expert who can find the best equipment for your system design and advise you on how to apply for approvals and permits.

### 6.2 Selecting a Supplier

Manufacturers and suppliers of renewable energy systems are a source of valuable information. They can help you evaluate a site, set up and install a system and ensure that it works properly. If you are contacting manufacturers about a specific site,

you should first find out (at least approximately) the head, the minimum and maximum flow rates, and the amount of power you want to generate. Unfortunately, unlike other renewable energy sectors in Canada, there is no national association to address the needs of micro-hydropower users.

A supplier should have proven experience in designing and installing the type of system you require. Different suppliers specialize in different types of systems. Some will supply only turbines, and others may supply only controllers. There are well-established small companies that offer turnkey installations and that will provide a full range of services from the pre-feasibility study onward. In terms of value for money, these probably are the best companies to deal with. You may wish to request and review catalogues and price lists; many catalogues also have useful information about system design. Manufacturers' hydroelectric equipment in the 1- to 5-kW range may appear to be expensive, but such equipment is likely to last longer and work much better than homemade systems. Many manufacturers have useful Web sites, and other information is available through the Internet.

Finding a local supplier or manufacturer is ideal because it makes it easier to transport the equipment, access spare parts and get advice. Remember to determine the price, warranty and conditions before committing to a purchase. In other words, shop around.

### 6.3 Safety and Protection

Many potential hazards can cause serious injury or be deadly when you are installing and operating a micro-hydropower system (e.g., falling off the intake, being struck by the rotating shaft or electrocution). Follow the manufacturer's safety instructions and precautions to the letter when handling any equipment. It is all too easy to think that safety is someone else's responsibility. It's not – it's yours. Whatever regulations and systems are in place, it ultimately comes down to you to follow them.

### **Electrical Protection**

All micro-hydropower systems that generate electricity will have some form of switchgear. The purpose of the switchgear is to isolate the generating unit when necessary, have control over the electrical power flow and protect the system. Some common switchgears are isolators, switches, fuses and circuit breakers. Switchgears are designed to protect against overloading and short-circuiting. They are crucial for the safety of persons and property and should never be neglected, even for low-voltage systems. The generating system and the load are also protected against over- or under-voltage and frequency. These protection systems are also linked to automatically activate a shutdown of the water flow into the turbine and power generation in the event of a critical malfunction.

Lightning protection must also be installed where power from a micro-hydropower system is transmitted from the powerhouse to a load by means

of a transmission line. The transmission line must be protected against direct and indirect lightning strikes.

The installation of the generator, control panels and all other electrical equipment must comply with the *Canadian Electrical Code* and should be undertaken only by a qualified and certified person. All electrical equipment should be grounded to protect against electric shock due to electric leakage or faulty wiring of the equipment. Wiring and grounding should meet national standards and be tested thoroughly. Ground fault interrupters, commonly used in homes, will disconnect the power if faults such as metal parts in the equipment become live or if there is a leakage of power to ground due to faulty insulation. Adequate guards for the turbine and all moving mechanical equipment must be provided and should be checked before starting the turbine.

## 7.0 Installing, Operating and Maintaining a System

### 7.1 Construction and Installation

The construction phase of the project is the most expensive. Before starting this phase, ensure that you have finalized every detail, including the final cost of the system, water licence, land-use approval and other local permits.

Depending on the size of the system, you may choose to do much of the work yourself or have the project done under contract. Construction and installation of a micro-hydropower system requires civil works, mechanical and electrical skills and experience working with heavy objects. You will need these skills to construct the intake and headrace canal; install and align the penstock, turbine and generator; build the powerhouse; and put up the transmission line.

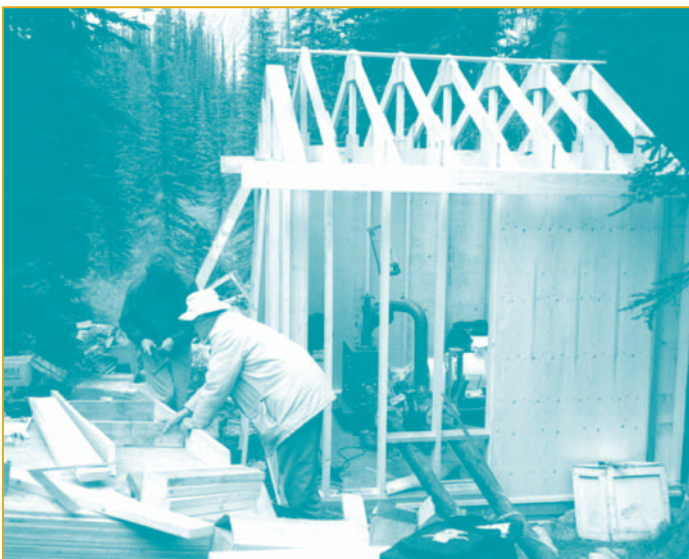

**Figure 28.** Powerhouse under construction for a 12-kW system (photo courtesy of Thomson and Howe Energy Systems Inc.)

The time of the year to construct the system can influence the pace and quality of work. From November to March, most parts of Canada experience high rainfall and snowfall and sub-freezing temperatures, which will slow down construction. There are also fewer daylight hours in winter. Access to remote areas may be difficult. Planning is key to successful and inexpensive

installations. Ensure that all equipment and materials will be delivered on time, and be aware that the cost of labour could be more than the cost of the materials and equipment. Performing some of the unskilled manual labour yourself and working with the contractor during construction can reduce labour costs substantially and provide invaluable experience in every aspect of the construction. After all, when construction is complete and the system is in operation, you will be left to maintain and operate it.



**Figure 29.** Burying a 20-cm (8-in.) Penstock pipe (photo courtesy of Thomson and Howe Energy Systems Inc.)

If you decide to build a system yourself, smaller battery-based systems are manageable with some guidance from the manufacturer. For larger systems, however, consult the experts.

### 7.2 Commissioning and Testing

The important final stage in installing a micro-hydropower system involves performance tests. The purpose is to check the performance of each component to ensure that it functions as it should and to measure overall performance to verify that it functions according to the design specification and parameters. The commissioning process will check,

for example, not only the amount of water flowing from the intake but also the overload protection of the generator. The tests include the total electrical power generation at design flow, penstock pressure tests, penstock losses, the turbine at rated and over speed, voltage and frequency protection trips, response time of the electronic load controller to load changes and automatic safety features under abnormal conditions, such as short-circuit and emergency shutdowns. All components must be fully tested. To ensure that safety protection devices are set correctly, the tests may need to be repeated several times.

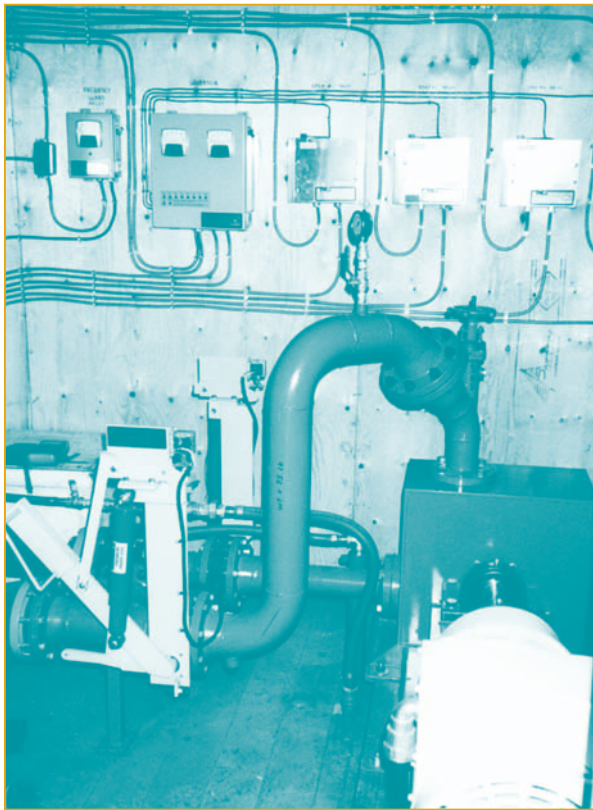

**Figure 30.** Equipment inside a powerhouse (photo courtesy of Thomson and Howe Energy Systems Inc.)

The commissioning procedure becomes much more complex as the system becomes larger in capacity. For larger systems, commissioning should be done in cooperation with the micro-hydropower system expert.

### 7.3 Operation and Maintenance

Operation and maintenance of micro-hydropower systems generally takes little time. It may be necessary, in extreme cases, to check the system daily to make sure that the intake is not becoming clogged and that the system is in good working order. Weekly or monthly inspection is much more common. Depending on the design of the system, you may also need to adjust the intake valve, nozzle or guide vane occasionally to match the water flow into the turbine with the amount of power you are using or to conserve the amount of water you have in the stream, especially in the dry season. More extensive maintenance, such as greasing the machinery and bearings, tightening of belts and checking the water level in the batteries for battery-based systems should be done every month.

It may also be necessary to clean out silt, weeds and so forth in the civil works and to repair any leaks or deterioration. This is usually done about once a year or as often as needed. The manufacturer normally provides detailed information on maintenance procedures and when they should be carried out. If possible, you should take the opportunity to become properly trained during the installation of the project. It is good practice and cost-effective to practise preventive maintenance rather than wait for the system to fail. A well-maintained micro-hydropower system can provide an uninterrupted power supply for many years.



**Figure 31.** Headwork structure and screen in Morehead Creek, British Columbia (photo courtesy of Thomson and Howe Energy Systems Inc.)

## 8.0 Further Information

### **Renewable and Electrical Energy Division Electricity Resources Branch Natural Resources Canada**

580 Booth Street, 17th Floor  
Ottawa ON K1A 0E4  
Fax: (613) 995-0087  
Web site: [www.reed.nrcan.gc.ca](http://www.reed.nrcan.gc.ca)

### **Renewable Energy Technologies CANMET Energy Technology Centre – Ottawa Natural Resources Canada**

580 Booth Street, 13th Floor  
Ottawa ON K1A 0E4  
Fax: (613) 996-9416  
Web sites:

- The CANMET Energy Technology Centre (CETC):  
[www.nrcan.gc.ca/es/etb](http://www.nrcan.gc.ca/es/etb)
- Canadian Renewable Energy Network:  
[www.canren.gc.ca](http://www.canren.gc.ca)
- International Small-Hydro Atlas:  
[www.small-hydro.com](http://www.small-hydro.com)

To order additional copies of this publication or to order other free publications on renewable energy and energy efficiency, call 1 800 387-2000 toll-free. You can also obtain a copy of this publication by visiting Natural Resources Canada's Canadian Renewable Energy Network (CanRen) Web site at [www.canren.gc.ca](http://www.canren.gc.ca).

### ***Free Software on Micro-Hydropower Systems***

RETScreen® International is a standardized, renewable energy project analysis software program that will help you determine whether a micro-hydropower system is a good investment for you. The software uses spreadsheets and comes with a comprehensive user's manual and supporting databases to help your evaluation. You can download the software and user manual free of charge from the Web site at [www.retscreen.net](http://www.retscreen.net), or call Natural Resources Canada at (450) 652-4621 or fax your request to (450) 652-5177.

### ***Manufacturers and Suppliers***

See the Canadian Renewable Energy Network Web site at [www.canren.gc.ca](http://www.canren.gc.ca) for a list of manufacturers and suppliers of micro-hydropower systems.



## Appendix A

### Determining Head and Flow Rate

#### Measuring Head

Head is the vertical distance that water falls from the forebay or intake to the turbine. It is measured in metres or feet. Measuring the available head is often seen as a task for a surveyor but, for many systems, much quicker and less costly methods can be used for preliminary determination of head. There are several ways to measure the available head, including maps, the pressure-gauge method, dumpy levels (builders' levels) and theodolites, sighting meters, the water-filled tube and rod method and altimeters.

Some measurement methods are more suitable for low-head sites but are too tedious and/or inaccurate for high-head sites. If possible, it is wise to take several separate measurements of the head at each site. It is best not to leave the site before analysing the results because any mistakes will be easier to check on-site. The head must be measured accurately because it is one of the most important considerations in the hydropower system's design and costing. The proposed location of the powerhouse

and penstock intake structure should be used as reference points in measuring the head. Several methodologies for measuring head are explained briefly in the following (adapted from *Micro-Hydro Design Manual: A Guide to Small-Scale Water Power Schemes*).

#### Maps

Detailed topographic maps are useful for locating potential sites and for obtaining a rough estimate of head levels at the proposed intake, tailrace water levels, the length of the pipelines, the size of the drainage area and the origin and destination of the stream. However, maps may not always be available or entirely reliable. For high head sites with more than 100 m (330 ft.) of head, 1:50 000 maps are useful. Smaller-scale maps are better because they have a higher contour resolution – 10 m (about 30 ft.) is typical. Topographic maps can be obtained from Natural Resources Canada through its Web site at [maps.nrcan.gc.ca](http://maps.nrcan.gc.ca). Provincial and territorial ministries for natural resources, land and water or your local forestry office may have more detailed maps at scales of 1:10 000 or 1:20 000.

#### Pressure-Gauge Method

This method can be used for high heads and low heads; the choice of pressure gauge depends on the head to be measured. A 20-m (65-ft.) length of transparent plastic pipe is good for measuring sites of approximately 60 m (200 ft.) of head. It is probably the best of the simple methods available. In this technique, the head is measured according to the static pressure of water. After the pressure is measured with a gauge, it is easily converted into the height of the head. A column of water 1 m high exerts a pressure equal to 9.8 kilopascals, or 1.42 pounds per square inch (PSI). If measuring in feet, multiply the pressure in PSI by 2.31 (e.g., 100 PSI =  $100 \times 2.31 = 231$  ft.).



Figure 32. Topographic map of Squamish, British Columbia

### Sighting Meters

Hand-held sighting meters, also known as inclinometers or Abney levels (see Figure 33), measure the slope's angle of inclination. They are accurate if used by an experienced operator, but it is always best to double-check the measurement. Sighting meters are compact, and some have range finders, which saves the trouble of measuring linear distance.

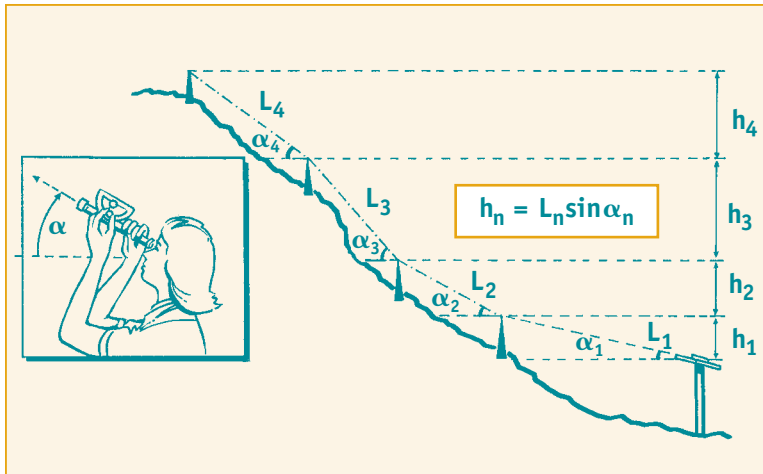

Figure 33. Measuring head using Abney-level method

### Dumpy Levels and Theodolites

A dumpy level (builder's level) is the conventional tool used for measuring head. An experienced operator who can check the level's calibration should make the measurement. When using a dumpy level, the operator takes a horizontal sight on a staff held by a colleague and needs an unobstructed view. A theodolite can measure vertical and horizontal angles.

A hypsometer, similar to a theodolite, is used by field foresters to calculate tree heights and can be adapted for measuring head. It requires an operator and an assistant to operate a reflection device; a clear line of sight is also needed. A hypsometer operates on the principle of electronic measuring of the linear distance and includes the angle of the measurement along with the distance. It can provide a fairly accurate measurement when used correctly.

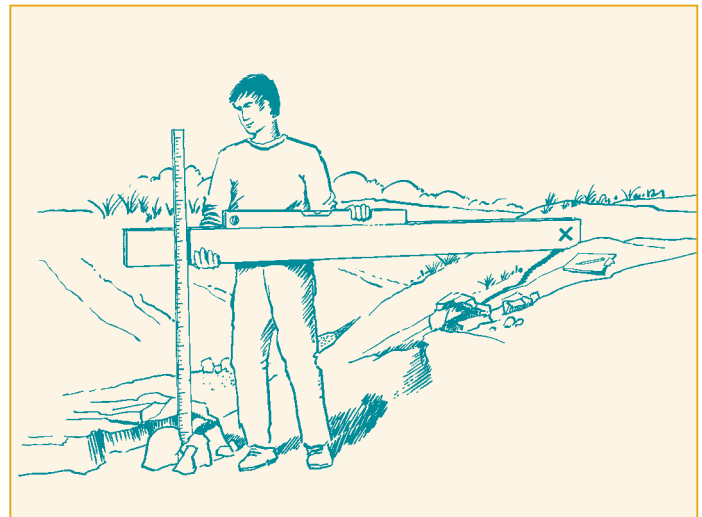

Figure 34. Measuring head using spirit level and plank method

### Water-Filled Tube and Rod Method

This method is suitable for low-head sites. It is reliable, reasonably accurate and inexpensive. Two or three separate measurements must be made in order to ensure that the results are consistent and reliable. Results from this method should be cross-checked against measurements made by another method, such as the pressure-gauge method. A carpenter's spirit level and a straight plank of wood can be used for steep slopes instead of a water-filled tube and rod (see Figure 34).

### Altimeters

Altimeters can be useful when undertaking high-head pre-feasibility studies. Atmospheric pressure variations should be taken into account, and this method is generally not recommended except to obtain an approximate reading. The best time to use this method is at midday, when there is the least atmospheric variation. Conventional altimeters are difficult to use; new, digital ones are easier. The principle of the altimeter is that it measures atmospheric pressure as indicated by a change in head of mercury of 9 mm for every 100-m change in elevation.

## Measuring Water Flow

### Flow Data

Flow rate is the quantity of water available in a stream or river and may vary widely over the course of a day, week, month and year. In order to adequately assess the minimum continuous power output to be expected from the micro-hydropower system, the minimum quantity of water available must be determined. The purpose of a hydrology study is to predict the variation in the flow during the year. It is important to know the mean stream flow and the extreme high- and low-flow rates.

Environmental and climatic factors and human activities in the watershed determine the amount and characteristics of stream flow on a day-to-day and seasonal basis. Generally, unless you are considering a storage reservoir, you should use the lowest mean annual flow as the basis for the system design.

There may be legal restrictions on the amount of water you can divert from a stream at certain times of the year; in such a case, you will have to use this amount of available flow as the basis of the design. The percentage of the maximum flow that may be diverted for power generation is defined during government approval of the water licence. Generally, 10 percent of mean annual discharge flow release is required in fish-bearing streams, but this could be lowered to 5 percent of mean annual discharge in non-fish-bearing streams. Mean annual discharge may also be different for a coastal stream than for a colder climate with snow and freshet flows. Non-classified drainages may sometimes have no flow release requirement. Most micro-hydropower systems may use only a fraction of the available water flow in the stream.

Whenever possible, stream flow data should be measured daily and recorded for at least one year; two to three years is ideal. If not, a few measurements should be made during the low-flow season. If you are familiar with the stream, you might determine the low-flow season by keeping track of water levels and making several flow measurements for more than a week when the water level is at its lowest point during the year. You may also be able to gather information from neighbours or other sources.

Daily stream flow data for your site may be available from the provincial water management branch or Environment Canada (EC). However, most micro-hydropower sites are on very small streams or creeks that are not monitored (gauged) by Environment Canada. Use of data from another stream requires multiplying the flow data by the ratio of the watershed area of your site and the environment site. The ratio should not be greater than 1.2 or less than 0.8.

$$\frac{\text{Watershed area ungauged (your site)}}{\text{Watershed area gauged (EC site)}} \times \text{daily flow (EC)} = \text{daily flow (your site)}$$

To delineate the watershed area of your site, topographic maps at 1:50 000 scale and assistance in watershed delineation are available from the following Web sites:

- [maps.nrcan.gc.ca](http://maps.nrcan.gc.ca)
- [www.nh.nrcs.usda.gov/technical/WS\\_delineation.html](http://www.nh.nrcs.usda.gov/technical/WS_delineation.html)

### Flow-Rate Measurement Methods

There are a variety of techniques for measuring stream flow rate; the most commonly used are briefly explained in this section. For more information on these methods, consult the bibliography.

- container method
- float method
- weir method
- salt and conductivity meter method
- current meter method

### Container Method

For very small streams, a common method for measuring flow is the container method. This involves diverting the whole flow into a container such as a bucket or barrel by damming the stream and recording the time it takes for the container to fill. The rate that the container fills is the flow rate, which is calculated simply by dividing the volume of the container by the filling time. Flows of up to 20 lps can be measured using a 200-litre container such as an oil drum.



**Figure 35.** Measuring water flow rate using container method

### Float Method

For larger streams where the construction of a weir may not be practical, or for a quick estimate of the flow, the float method is useful. The principle of all velocity-area methods is that flow (Q) equals the mean velocity ( $V_{\text{mean}}$ ) multiplied by the cross-sectional area (A):

$$Q \text{ (m}^3\text{/s)} = A \text{ (m}^2\text{)} \times V_{\text{mean}} \text{ (m/s)}$$

One way of using this principle is for the cross-sectional profile of a streambed to be charted and an average cross section established for a known length of stream. A series of floats, perhaps pieces of wood, are timed over this measured length of stream. Results are averaged and a flow velocity is obtained. This velocity must then be reduced by a correction factor, which estimates the mean velocity as opposed to the surface velocity. By multiplying averaged and corrected flow velocity, the volume flow rate is estimated. This method provides only an approximate estimate of the flow.

Approximate correction factors to convert measured surface velocity to mean velocity are as follows:

Concrete channel, rectangular, smooth	0.85
Large, slow, clear stream	0.75
Small, slow, clear stream	0.65
Shallow (less than 0.5 m / 1.5 ft.) turbulent stream	0.45
Very shallow, rocky stream	0.25

### Weir Method

A weir is a structure such as a low wall across a stream. A flow measurement weir has a notch through which all water in the stream flows. The flow rate can be determined from a single reading of the difference in height between the upstream water level and the bottom of the notch. For reliable results, the crest of the weir must be kept sharp, and sediment must be prevented from accumulating behind the weir.

Weirs can be timber, concrete or metal and must always be oriented at a right angle to the stream flow. The weir should be located at a point where the stream is straight and free from eddies. It is necessary to estimate the range of flows to be measured before designing the weir in order to ensure that the chosen size of notch will be adequate to pass the magnitude of the stream flow. Rectangular weirs are more suitable for large flows in the range of 1000 lps, and triangular weirs are suitable for small flows that have wide variation. A combination triangular/rectangular compound weir may be incorporated into one weir to measure higher flows; at lower flows the water goes through the triangular notch.

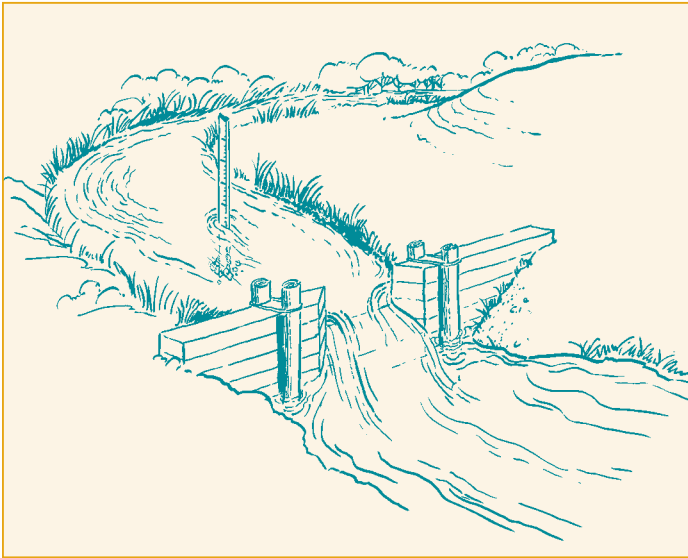

**Figure 36.** Measuring water flow rate using weir method

### **Salt and Conductivity Meter Method**

Using the salt and conductivity meter method, stream flow can be measured in a very short time and has proven easy to do, reasonably accurate and reliable for a wide range of stream types. It gives better results than other methods for more turbulent streams. The main device is a conductivity meter. The calculation takes a little longer if done manually; alternatively, calculation can be done automatically with an integrating meter that will provide measurement in litres per second.

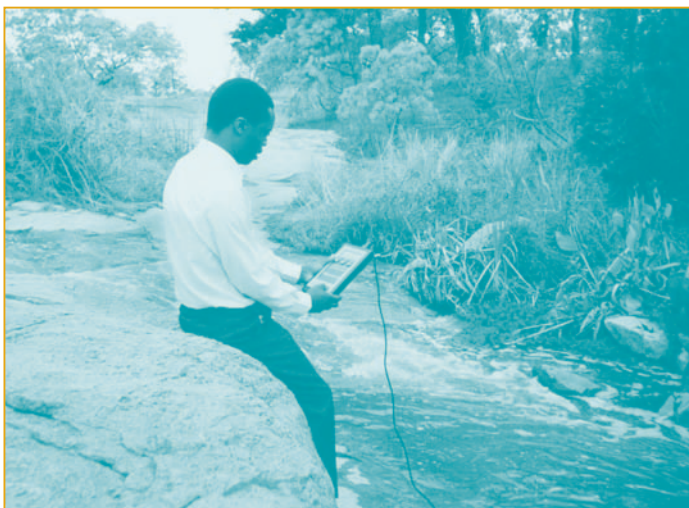

**Figure 37.** Flow measurement using an integrating meter (photo courtesy of Dulas Engineering Ltd.)

A bucket of heavily salted water is poured into the stream. The cloud of salty water in the stream starts to spread out while travelling downstream. At a certain point, it will fill the width of the stream. The cloud will have a leading part, which is weak in salt, a middle part, which is strong in salt, and a lagging part, which is weak. The salinity of the water is measured with an electrical conductivity meter. A low-flow stream will not dilute the salt very much, so the electrical conductivity of the cloud will be high. Therefore, low flows are indicated by high conductivity and vice versa. The flow rate is therefore inversely proportional to the degree of conductivity of the cloud. The slower the flow, the longer the cloud takes to pass the probe of the meter. Therefore, flow is also inversely proportional to the time it takes for the cloud to travel.

It is recommended to use about 100 g of salt for every 100 lps of flow. As with all methods, the measurements should be made at least twice to confirm the accuracy of the measurement.

### **Current Meter Method**

A current meter is essentially a shaft with a propeller or wheel of revolving cups at one end. When submersed, the propeller rotates at the speed of the water current. A mechanical counter records the number of revolutions of the propeller when placed at a desired depth (indicated by a marker on the propeller handle). By averaging readings taken evenly throughout a stream cross section, an average velocity can be determined. Current meters use a formula that relates rotational speed of the propeller to the speed of the water current; the formula is supplied with the meter.

## Appendix B

### Sample Data Sheet

Project name: \_\_\_\_\_

#### A. Stream Characteristics

1. Site location: \_\_\_\_\_
2. Available flow rate: \_\_\_\_\_ lps
3. Design flow rate: \_\_\_\_\_ lps
4. Head gross (static): \_\_\_\_\_ m
5. Length of penstock: \_\_\_\_\_ m
6. Diameter of penstock: \_\_\_\_\_ m
7. Existing intake?  Yes  No

#### B. Electrical Characteristics

8. Voltage required: \_\_\_\_\_ V (AC/DC)
9. Frequency: \_\_\_\_\_ Hz
10. Phases: \_\_\_\_\_
11. Expected output power: \_\_\_\_\_ kW
12. Length of transmission line: \_\_\_\_\_ m
13. Control method desired:  Automatic  Manual

List electrical needs: \_\_\_\_\_  
 \_\_\_\_\_  
 \_\_\_\_\_  
 \_\_\_\_\_

#### C. Contact Information

Name: \_\_\_\_\_  
 Address: \_\_\_\_\_  
 City: \_\_\_\_\_  
 Province/territory: \_\_\_\_\_  
 Postal code: \_\_\_\_\_ Telephone: \_\_\_\_\_  
 Fax: \_\_\_\_\_ E-mail: \_\_\_\_\_

## Appendix C

### Typical Household Appliance Loads

Appliances	Power Rating (W)	Average Hours per Month	Energy Used (kWh) per Month
<b>Kitchen</b>			
Blender	350	3	1
Coffee maker	900	12	11
Deep fryer	1500	8	12
Dishwasher*	1300	20	26
Exhaust fan	250	30	8
Electric kettle	1500	10	15
Food freezer (15 cu. ft.)	350	240	84
Hot plate (one burner)	1250	14	18
Microwave oven (0.5 cu. ft.)	900	10	9
Microwave oven (0.8 to 1.5 cu. ft.)	1500	10	15
Mixer	175	6	1
Range	4000	25	100
Range and oven	3500	25	90
Refrigerator-freezer			
Frost-free (17 cu. ft.)	500	300	150
Non-frost-free (11.5 cu. ft.)	300	300	90
Toaster	1200	4	5
<b>Laundry</b>			
Clothes dryer (35 loads/month)	5000	28	140
Washing machine* (33 loads/month)	500	26	13
Front-loading washer*	160	26	4
Iron	1000	12	12
Electric water heaters			
Family of two	3800	80	304
Family of four	3800	140	532
<b>Comfort and Health</b>			
Air conditioner	750	74	56
Electric blanket	180	80	14
Electric heating	1000	250	250
Fan (portable)	120	6	1

\* Excluding hot water requirements

<b>Appliances</b>	<b>Power Rating (W)</b>	<b>Average Hours per Month</b>	<b>Energy Used (kWh) per Month</b>
Hair dryer (hand-held)	1000	5	5
<b>Lights</b>			
Incandescent bulb (60 W)	60	120	7
Incandescent bulb (100 W)	100	90	9
Fluorescent (4 ft.)	50	240	12
Compact fluorescent lamp (24 W)	24	240	6
Portable electric heater	1000	350	350
Telephone, portable	3	720	2
Telephone answering machine	6	720	4
<b>Entertainment</b>			
Computer (desktop)	250	240	60
Computer (laptop)	30	240	7
Laptop charger	100	240	24
Laser printer	600	60	36
Radio	5	120	1
Stereo	120	120	14
Television (colour)	100	125	13
Television (black and white)	60	120	7
Video cassette recorder	40	100	4
<b>Outdoors</b>			
Block heater	600	120	72
Lawn mower	1000	10	10
<b>Workshop tools</b>			
¼-inch drill	250	4	1
Circular saw	1000	6	6
Table saw	1000	4	4
Lathe	460	2	1
<b>Other</b>			
Clock	2	720	1
Sewing machine	100	10	1
Vacuum cleaner	800	10	8
Water pump (½ hp)	1000	44	44



## Appendix D

### Costing Estimate Worksheet

Initial Costs	No. of Units	Cost per Unit	Total Cost (\$)
<b>Civil works</b>			
Intake			
Headrace canal			
Forebay			
Penstock pipe			
Powerhouse and tailrace			
<b>Total civil works cost</b>			
<b>Electro-mechanical equipment</b>			
Turbine and generator set			
Controller			
Electrical switchgear			
Transmission line cables and gears			
Transmission line poles			
Battery bank and inverter*			
<b>Total electro-mechanical equipment</b>			
<b>Planning and development costs</b>			
Pre-feasibility study			
Feasibility study			
Permit and approvals			
Engineering			
Transportation			
Construction and installation			
Contingency			
<b>Total planning and development costs</b>			
<b>Total initial costs</b>			
<b>Annual costs</b>			
Operation and maintenance			
Spare parts			
Water rental fee		Annual	
Land lease		Annual	
Miscellaneous			
<b>Total annual costs</b>			

\* Applies only to battery-based systems

## Glossary of Terms and Abbreviations

### Terms

**Alternating current (AC):** Electric current that flows in one direction and then in the reverse direction. In North America, the standard cycle frequency is 60 Hz; in Europe it is 50 Hz. Alternating current is used universally in power systems because it can be transmitted and distributed much more economically than direct current.

**Base load:** The amount of electrical power that needs to be delivered at all times and during all seasons.

**Capacitor:** A dielectric device that momentarily absorbs and stores electric energy.

**Capacity:** The maximum power capability of a power-generating system. Common units used are kilowatts or megawatts.

**Capacity factor:** The ratio of the energy that a power-generating system produces to the energy that would be produced if it were operated at full capacity throughout a given period, usually one year.

**Compact fluorescent light (CFL):** A modern light bulb with integral ballast using a fraction of the electricity used by a regular incandescent light bulb.

**Current:** The rate of flow of electricity, measured in amperes, or amps. Analogous to the rate of flow of water measured in litres per second.

**Direct current (DC):** Electricity that flows continuously in one direction, such as from a battery.

**Efficiency:** The ratio of the output to the input of energy or power, expressed as a percentage.

**Energy:** The ability to do work; the quantity of electricity delivered over a period of time. The electrical energy term commonly used is kilowatt hours (kWh), which represents the power (kW) operating over some period of time (hours); 1 kWh = 3600 kilojoules.

**Flow:** The quantity of water being used to produce power. This is usually measured in units of cubic metres per second, cubic feet per minute, litres per second or gallons per minute.

**Frequency:** The number of cycles through which an alternating current passes in a second, measured in Hertz (Hz).

**Generator:** A rotating machine that converts mechanical energy into electrical energy.

**Grid:** A utility term for the network of wires that distributes electricity from a variety of sources across a large area.

**Head:** The difference in elevation between two water surfaces, measured in metres or feet. *Gross head:* The vertical drop between the intake of a pipeline (penstock) and the outlet (location of turbine). *Net head:* The usable head after subtracting losses in the penstock pipe.

**Hertz (Hz):** Unit of frequency measurement for AC. Equivalent to “cycles per second,” common household utility power is normally 60 Hz in North America.

**Inverter:** An electronic device used to convert DC electricity into AC, usually with an increase in voltage.

**Joule (J):** The international unit of energy. The energy produced by a power of one watt flowing for one second.

**Kilowatt (kW):** The commercial unit of electrical power; 1000 watts.

**Kilowatt hour (kWh):** A measurement of energy. One kilowatt hour is equal to one kilowatt being used for one hour.

**Load:** The collective appliances and other devices connected to a power source.

**Megawatt (MW):** A measurement of power equal to 1 million watts.

**Net-metering:** A form of buy-back agreement in which the grid-supplied house electricity meter turns or measures in the utility's favour when grid electric power is consumed by the house, and in the house owner's favour when the house's own generation exceeds its needs and electricity flows into the grid. At the end of the payment period, when the meter is read, the system owner pays the utility the difference between what the house consumed and what was supplied to the grid.

**Off-grid:** Not connected to power lines; electrical self-sufficiency.

**Output:** The amount of power delivered by a system.

**Over speed:** The speed of the turbine runner when, under design conditions, all external loads are removed.

**Peak load:** The electric load at the time of maximum demand.

**Penstock:** A pipe that conveys water under pressure from the forebay to the turbine.

**Phantom loads:** Appliances that draw power 24 hours a day, even when turned off. Televisions, VCRs, microwave ovens with clocks and computers all contain phantom loads.

**Power:** The rate of doing work, or more generally, the rate of converting energy from one form to another. Measured in joules/second or watts (1 W = 1 J/s). Electrical power is measured in kilowatts.

**Power factor:** The ratio of an appliance's actual power in watts to the apparent power measured in volt-amps (VA). As an example, a 400-W appliance with a power factor of 0.8 would require a power source of 500 VA to drive it properly. This is why loads with poor power factors need larger-than-expected generators to power them.

**Run-of-river:** Hydropower systems where water is used at a rate no greater than that which runs down the river.

**Transformer:** A device consisting of two or more insulated coils of wire wound around a magnetic material such as iron, used to convert one AC voltage to another or to electrically isolate the individual circuits.

**Turbine:** A device that converts kinetic energy of flowing water to mechanical energy. Often used to drive generators or pumps.

**Voltage (V):** Measure of electrical potential; the electrical "pressure" that forces an electrical current to flow through a closed circuit.

**Watt (W):** The scientific unit of electrical power; a rate of doing work at the rate of one joule per second. Commonly used to define the rate of electricity consumption of an electric appliance.

## Abbreviations

Ah	=	ampere hour
AC	=	alternating current
CFL	=	compact fluorescent lamp
cfm	=	cubic feet per minute
DC	=	direct current
DILC	=	distributed intelligent load controller
e	=	efficiency
EC	=	Environment Canada
ELC	=	electronic load controller
FDC	=	flow duration curve
ft.	=	foot; feet
gpm	=	gallons per minute
H	=	gross head
h	=	net head
Hz	=	hertz
IGC	=	induction generator controller
in.	=	inch
kW	=	kilowatt
kWh	=	kilowatt hour
lps	=	litres per second
m	=	metre
MAD	=	mean annual discharge
P	=	power
PSI	=	pounds per square inch
Q	=	flow rate
rpm	=	revolutions per minute
V	=	voltage
W	=	watt

## Bibliography

### Books

- Davis, Scott. *Microhydro: Clean Power from Water* (draft). British Columbia: New Society Publishers, 2003.
- DCS – Technology Development and the International Centre for Integrated Mountain Development (ICIMOD). *Manual for Survey and Layout Design of Private Micro-Hydropower Plants*. Butwal, Nepal: DCS – Technology Development; Kathmandu, Nepal: ICIMOD, 1999.
- Fraenkel, Peter, et al. *Micro-Hydro Power: A Guide for Development Workers*. London, U.K.: Intermediate Technology Publications in association with the Stockholm Environment Institute, 1991.
- Harvey, Adam, et al. *Micro-Hydro Design Manual: A Guide to Small-Scale Water Power Schemes*. London, U.K.: Intermediate Technology Publications, 1993.
- Inversin, Allen R. *Micro-Hydropower Sourcebook: A Practical Guide to Design and Implementation in Developing Countries*. Washington, DC: National Rural Electric Cooperative Association International Foundation, 1986.
- Newfoundland and Labrador Department of Mines and Energy. *Micro-Hydro Power in Newfoundland and Labrador*. St. John's, 1984.
- Ontario. Ministry of Energy. *Micro-Hydro Power: Energy from Ontario Streams*. Toronto, 1982.
- Ontario. Ministry of Energy. *Streams of Power: Developing Small Scale Hydro Systems*. Toronto, 1986.
- Penche, Celso. *Layman's Guidebook on How to Develop a Small Hydro Site*, 2nd edition. Brussels, Belgium: Commission of the European Communities, Directorate General for Energy (DG XVII), European Small Hydropower Association (ESHA), 1998.
- Smith, Nigel. *Motors as Generators for Micro-Hydro Power*. London, U.K.: Intermediate Technology Publications, 1997.
- Solar Energy Society of Canada Inc. *The Canadian Renewable Energy Guide*, 2nd edition. Regina, 1999.
- Williams, Arthur. *Pumps as Turbines: A User's Guide*. London, U.K.: Intermediate Technology Publications, 1995.

### Manuals

- BC Hydro. *Handbook for Developing Micro Hydro in British Columbia* (Draft), 2002.
- Canada Mortgage and Housing Corporation. *Energy Use Patterns in Off-Grid Houses*, Research Highlights – Technical Series 01-103.
- Energy, Mines and Resources Canada. Efficiency and Alternative Energy Technology Branch. *Canadian Small Hydropower Handbook: British Columbia Region*. Ottawa, 1989.
- Mathews, Robert. Micro-hydro course, Appropriate Energy Systems, British Columbia, 2000.
- National Centre for Appropriate Technology. *Micro-Hydro Power: Reviewing an Old Concept*. Butte, Montana, 1979.
- Natural Resources Canada. CANMET Energy Technology Centre (CETC). RETScreen® International, Background – Small Hydro Project, Varennes.
- Natural Resources Canada. Renewable and Electrical Energy Division. Energy Resources Branch. *Stand-Alone Wind Energy Systems: A Buyer's Guide*. Ottawa, 2000.

### Technical Papers

- Cunningham, Paul and Atkinson, Barbara. "Micro Hydro Power in the Nineties," *Homepower*, No. 44 (December 1994 / January 1995), pp. 24–29.
- Intermediate Technology Development Group (ITDG). *Micro-Hydro Power* (technical brief).
- U.S. Department of Energy. National Renewable Energy Laboratory. *Small Hydropower Systems* (DOE/GO-102001-1173 FS217), July 2001.
- U.S. Department of Energy. Office of Energy Efficiency and Renewable Energy. Consumer Energy Information: EREC Reference Briefs. *Is a Micro-Hydroelectric System Feasible for You?* November 2002.
- Weaver, Christopher S. *Understanding Micro-Hydroelectric Generation*, Technical Paper No. 18. Volunteers in Technical Assistance (VITA), 1985.
- Weaver, Christopher S. *Understanding Mini-Hydroelectric Generation*, Technical Paper No. 19. Volunteers in Technical Assistance (VITA), 1985.

## Useful Web Sites

### Organizations

BC Hydro:  
[www.bchydro.com/environment/greenpower/greenpower1751.html](http://www.bchydro.com/environment/greenpower/greenpower1751.html)

British Hydropower Association:  
[www.british-hydro.org](http://www.british-hydro.org)

David Suzuki Foundation:  
[www.davidsuzuki.org](http://www.davidsuzuki.org)

EnerGuide, Office of Energy Efficiency, Natural Resources Canada:  
[oee.nrcan.gc.ca/energuide/home.cfm](http://oee.nrcan.gc.ca/energuide/home.cfm)

Friends of Renewable Energy BC:  
[www.forebc.com](http://www.forebc.com)

Green Empowerment:  
[www.greenempowerment.org/resources.htm](http://www.greenempowerment.org/resources.htm)

Intermediate Technology Development Group (ITDG):  
[www.itdg.org](http://www.itdg.org)

International Small-Hydro Atlas:  
[www.small-hydro.com](http://www.small-hydro.com)

Micro Hydro Centre:  
[www.eee.ntu.ac.uk/research/microhydro](http://www.eee.ntu.ac.uk/research/microhydro)

Micro-hydro Web portal:  
[www.microhydropower.net](http://www.microhydropower.net)

MicroPower Connect:  
[www.micropower-connect.org](http://www.micropower-connect.org)

Natural Resources Canada (topographic maps):  
[maps.nrcan.gc.ca](http://maps.nrcan.gc.ca)

Office of Energy Efficiency and Renewable Energy, U.S. Department of Energy:  
[www.eren.doe.gov/consumerinfo/refbriefs/ab2.html](http://www.eren.doe.gov/consumerinfo/refbriefs/ab2.html)

RETScreen® International:  
[www.retscreen.net](http://www.retscreen.net)

Tax incentive for businesses:  
[www.canren.gc.ca/app/filerepository/General-tax\\_incentives.pdf](http://www.canren.gc.ca/app/filerepository/General-tax_incentives.pdf)

Volunteers in Technical Assistance (VITA):  
[www.vita.org](http://www.vita.org)

### Companies

Asia Phoenix Resources Ltd.:  
[www.powerpal.com](http://www.powerpal.com)

Canadian Hydro Components Ltd.:  
[www.canadianhydro.com](http://www.canadianhydro.com)

Canyon Industries Inc.:  
[www.canyonindustriesinc.com](http://www.canyonindustriesinc.com)

Dependable Turbines Ltd.:  
[www.dtlhydro.com](http://www.dtlhydro.com)

Dulas Engineering Ltd.: [www.dulas.org.uk](http://www.dulas.org.uk)

Mini-Grid Systems/Econnect Ltd.:  
[www.mini-grid.com](http://www.mini-grid.com)

Energy Alternatives:  
[www.energyalternatives.ca](http://www.energyalternatives.ca)

Energy Systems & Design:  
[www.microhydropower.com](http://www.microhydropower.com)

Evans Engineering Ltd.:  
[www.microhydro.com](http://www.microhydro.com)

Harris Hydroelectric:  
[www.harrishydro.com](http://www.harrishydro.com)

IT Power: [www.itpower.co.uk](http://www.itpower.co.uk)

Morehead Valley Hydro Inc.:  
[www.smallhydropower.com](http://www.smallhydropower.com)

Ottawa Engineering Limited:  
[www.ottawaengineering.com](http://www.ottawaengineering.com)

Powerbase Automation Systems Inc.:  
[www.powerbase.com](http://www.powerbase.com)

Sustainable Control Systems Ltd.:  
[www.scs-www.com](http://www.scs-www.com)

Thomson and Howe Energy Systems Inc.:  
[www.smallhydropower.com/thes.html](http://www.smallhydropower.com/thes.html)

Yalakom Appropriate Technology:  
[www.yalatech.com](http://www.yalatech.com)

### Micro-Hydropower Systems in Action

CADDET Centre for Renewable Energy:  
[www.caddet-re.org](http://www.caddet-re.org)

Homepower:  
[www.homepower.ca](http://www.homepower.ca)

Micro-hydropower course on-line:  
[www.energyalternatives.ca](http://www.energyalternatives.ca)



# Reader Survey

Thank you for your interest in NRCan's *Micro-Hydropower Systems: A Buyer's Guide*.  
To help us improve this guide, please take a few minutes to complete this questionnaire.

**1. Where did you receive your copy of the Buyer's Guide?**

- Introductory brochure (NRCan)       Dealer       Retail store       Trade show  
 Renewable energy association       Internet       Other (please specify): \_\_\_\_\_

**2. Did you find this publication informative?**       Yes       No

**3. How much did you know about micro-hydropower systems before reading the Buyer's Guide?**

- Everything       A lot       A little       Nothing

**4. Please rate this guide on the following characteristics:**

	Excellent	Good	Fair	Poor
Easy to understand	<input type="checkbox"/>	<input type="checkbox"/>	<input type="checkbox"/>	<input type="checkbox"/>
Length	<input type="checkbox"/>	<input type="checkbox"/>	<input type="checkbox"/>	<input type="checkbox"/>
Clarity	<input type="checkbox"/>	<input type="checkbox"/>	<input type="checkbox"/>	<input type="checkbox"/>
Completeness	<input type="checkbox"/>	<input type="checkbox"/>	<input type="checkbox"/>	<input type="checkbox"/>
Photography	<input type="checkbox"/>	<input type="checkbox"/>	<input type="checkbox"/>	<input type="checkbox"/>
Graphics	<input type="checkbox"/>	<input type="checkbox"/>	<input type="checkbox"/>	<input type="checkbox"/>
Format/organization	<input type="checkbox"/>	<input type="checkbox"/>	<input type="checkbox"/>	<input type="checkbox"/>

Please add comments or suggestions: \_\_\_\_\_

**5. If you were to install a micro-hydropower system, it would be for a:**

- Rural resident       Cottage       Lodge       Farm       Park       Remote community       Other: \_\_\_\_\_  
(please specify)

**6. Would you like to receive more information on micro-hydropower systems?**       Yes       No

**7. Would like to receive a list of dealers or installers in your area?**       Yes       No

Your answers are confidential. If you would like to give us your contact details, please provide them below (please print):

Name: \_\_\_\_\_

Street: \_\_\_\_\_

City: \_\_\_\_\_ Province/Territory: \_\_\_\_\_ Postal code: \_\_\_\_\_

Telephone: \_\_\_\_\_ E-mail: \_\_\_\_\_

Please send completed form to:

Natural Resources Canada  
Renewable and Electrical Energy Division  
580 Booth Street, 17th Floor  
Ottawa ON K1A 0E4  
Fax: (613) 995-0087

**Thank you!**

