

LIGHTING

Reference Guide



DISCLAIMER: CEA Technologies Inc., Natural Resources Canada, the Ontario Ministry of Energy, Energy @ Work or any other person acting on their behalf will not assume any liability arising from the use of, or damages resulting from the use of any information, equipment, product, method or process disclosed in this guide.

It is recommended to use certified practitioners for the applications of the directives and recommendations contained herein.

Funding support provided by:



Natural Resources
Canada

Ressources naturelles
Canada



© Her Majesty the Queen in Right of Canada, 2005

Revisions provided by: Mr. Gerry Cornwell, LC,
Architectural Lighting Design; Mr. Scott Rouse, P.Eng., MBA,
CEM, Energy @ Work, www.energy-efficiency.com

Appreciation to Ontario Hydro, Ontario Power Generation and others that have contributed to material that has been used in preparing this guide.

TABLE OF CONTENTS

Page	Section
6	1 Introduction
7	2 Energy Savings
9	3 Emission Reduction Credits
11	4 Applications
11	a. Lighting Project Management
12	b. Evaluation Methods
14	c. Lighting Levels
14	d. Light and the Environment
15	e. Technology Integration
15	f. Case Studies
24	5 Understanding the Theory
24	a. Definition of Light
26	b. Visual Effect of Light
27	c. Spectral Power Distribution
29	d. Lighting and Colour
34	e. Lighting Quantities and Units
37	f. Lighting Levels

40 6 Generation of Light

40 a. Light Sources

42 b. Lamp Types

45 c. Lighting Systems

47 7 Incandescent Lamps

47 a. Incandescent Lamps (Shapes and Designation)

52 b. Tungsten Halogen Lamps

56 c. Halogen PAR Lamps

60 d. IR Halogen Lamps

61 e. Infrared Heat Lamps

66 8 Fluorescent Lamp Ballasts

66 a. Ballasts General

71 b. Electronic Ballasts for Fluorescent Lamps

77 9 Fluorescent Lamps

77 a. Fluorescent Lamps General
(Shapes and Designation)

89 b. Premium T-8 Lamps

89 c. Low-Wattage T-8 Lamps

89 d. T5 Fluorescent Lamps

91 e. Fluorescent Fixture Reflectors

95 f. Compact Fluorescent Lamps

102 10 HID Lamp Ballasts

102 a. Ballasts General

102	b. Probe Start Ballasts
102	c. Pulse Start Ballasts
103	d. Electronic HID Lamp Ballasts
104	11 HID Lamps, LPS Lamps
104	a. Mercury Vapour Lamps
110	b. Metal Halide Lamps
117	c. High Pressure Sodium Lamps
123	d. Low Pressure Sodium Lamp
126	12 Other Light Sources
126	a. Induction Lighting
127	b. Fiber Optic Lighting
128	c. LED Lighting
130	13 Exit Signs
137	14 Emerging Technologies
139	15 Codes, Standards and Regulations
141	16 Worksheets
141	a. An Audit Data Worksheet
143	b. A Measure/Savings Worksheet
144	17 Bibliography
145	18 Glossary of Terms
149	19 Index

1 INTRODUCTION

This is a practical guide, designed to provide information on lighting technology that will help to improve energy efficiency opportunities through a designed approach by understanding components and technologies that are commercially available.

It is strongly recommended that individuals or companies undertaking comprehensive energy efficiency projects secure the services of a professional energy efficiency specialist qualified in lighting design, to maximize the benefits and return on investment by considering the internal rate of return and related benefits of a 'quality' design.

2 ENERGY SAVINGS

Increasing energy costs have become a significant concern and are expected to continue to increase in the foreseeable future. Businesses, institutions and consumers will be searching for more efficient products and solutions. Business applications for more efficient products are available and even greater opportunities exist in the largely untapped residential market. Lighting is recognized as a major area for economic energy savings.

Programs are in place to influence market and consumer choices towards more energy efficient products. For example, “Energide for Houses and R2000”, Energide for Existing Buildings (EEB), and Commercial Building Incentive Program (CBIP)” along with the use of the Energy Star labelling program are some of the NRCan programs to promote energy efficient lighting products.

There are also national efforts to mandate and in some cases regulate energy efficiency and appear in various forms such as codes and standards and building guidelines to limit energy use within a building such as ASHRAE-IES 90.1, DOE Standard for Federal Buildings, Equipment regulations - US National Appliance Energy Conservation Act Amendment of 1988 and Energy Policy Act of 1992, etc.

2 Energy Savings

Achieving lighting energy savings is considered one of the fundamental energy efficiency measures with numerous opportunities and supporting benefits. Choices include:

- replacing incandescent with fluorescent or HID lamp types.
- redesigning older fluorescent lamp configurations to meet present applications, such as in industrial plants with upgraded fixtures or better technology. The HID example was suggested in the case study.

Lighting projects, executed properly and comprehensively can be easily justified for a number of reasons including:

- energy savings, often a 25% internal rate of return or better;
- emission reductions, direct correlation between energy and emission reduction;
- maintenance cost savings from replacing inefficient systems;
- increasing light levels for tenant comfort or improved safety considerations;
- improved CRI to enhance comfort.

3 EMISSION REDUCTION CREDITS

Canada ratified the Kyoto Protocol on February 16, 2005. This will lead to the economic value of emission reductions.

Reducing energy use can be directly tied to emission reductions and calculated from the energy saved either on site or off site by the type of generation. The quantification of the emissions has been successfully used to create 'Emission Reduction Credits' (ERCs) or in some cases, 'offset allowances'. These are usually measured in either sulfur dioxide (SO₂), nitrogen oxides (NO_x) or gases e.g., Equivalent Carbon Dioxide (CO_{2e}). The credits or allowances can be created when a company takes an initiative to improve efficiency and reduce emissions to offset greenhouse gases.

Credits or allowances will be allocated through numerous methods. The most common are process modifications, energy efficiency, fuel switching, new equipment, etc. Lighting becomes a major opportunity because the technology is considered 'proven' and can be easily replicated.

Energy savings are usually calculated in kilowatt-hours, (kWh) and converted to Emission Reduction Credits or allowances, based on the method by which the energy was generated.

3 Emission Reduction Credits

Industry pilots, such as the Pilot Emission Reduction Trading or “PERT” as well as Greenhouse Gas Emission Reduction Trading or “GERT” established the viability and suggested rules for registering and trading emission credits. Information is available from Environment Canada’s website:

<http://www.ec.gc.ca/nopp/lfg/primer/en/primer.cfm?pg=5>

Ratification of Kyoto is expected to accelerate the commercial value of emission reduction credits with eventual trading of emission credits or approved allowances. The federal government is in the process of defining the rules for the creation of greenhouse gas allowances within Canada.

Provincially there are specific initiatives underway for SO_x and NO_x reduction. For example, in Ontario offsets can be created and made available through a provincial registry. The allowances can be created from energy improvements, especially lighting improvements.

10

A good source of information in this dynamic area is from Environment Canada’s Envirozine online:

http://www.ec.gc.ca/envirozine/english/issues/47/any_questions_e.cfm

or specific information on Canada’s Kyoto commitment from the Government of Canada’s climate change website:

http://www.climatechange.gc.ca/cop/cop6_hague/english/kyoto_e.html

4 APPLICATIONS

a. Lighting Project Management

The objective of a “**quality**” lighting design is to provide a safe and productive environment – whether for business or pleasure. This is accomplished by a redesign or upgrade to ensure that the appropriate quality and quantity of light is provided for the users of the space, at the lowest operating and maintenance cost.

A “**quality**” lighting design addresses more than ‘first cost’ issues. Either Net Present Value (NPV) or the Internal Rate of Return (IRR) can properly evaluate life cycle costs.

Proper evaluation of the data, planning and execution are essential for successful implementation. Building systems are inter-related. For example, removing 10 kW of lighting energy from a commercial building will have a significant impact on the heating, ventilation air conditioning system. Cooling cost will be reduced, but replacement heating may be required. It is necessary for the lighting designer to have a clear understanding of all the building systems and how they interrelate.

Typical ‘lowest (first cost)’ projects save energy, but they usually do not maximize the saving potential in the building. This can result in a ‘re-lamping’ exercise that provides a 10 to 30% savings, but prevents a lighting designer from returning to the project to maximize savings at a later date. *Valuable energy reductions are sacrificed.*

4 Applications

For example, in a commercial building in Toronto, the original scope of work would have resulted in electrical lighting savings of 37%, which on the surface would appear to be a respectable objective. However, a lighting designer was retained and a comprehensive design solution was provided. The project achieved:

- lighting energy savings of 63%;
- reduced payback;
- an Internal Rate of Return of more than 30%; and
- solutions for related building issues such as maintenance, end of fixture life, etc.

The 'first cost' was higher, however the life cycle cost as calculated using either the Net Present Value or the Internal Rate of Return proved a significantly superior solution.

b. Evaluation Methods

12

The methodology used to evaluate the energy savings for a lighting project, either for a retrofit or a comparison for new projects, is critical to the success of installing a complete energy efficient solution. Too often the simple payback method is used which undervalues the financial benefit to the organization. Following are brief descriptions of the various payback evaluation methods. It is important that the choice of method reflects the same principles the company uses when evaluating other capital investments.

Life Cycle Costing

A proper life cycle costing analysis will provide a more realistic financial picture of an energy retrofit project than a simple payback evaluation. Unfortunately, energy efficiency has been a low priority and for convenience, the 'Simple Payback' analysis is often used to evaluate energy projects, particularly for lighting projects.

- Simple Payback consists of the project capital cost divided by the annual energy savings realized. The result is the number of years it takes for the savings to pay for the initial investment, e.g.; \$100,000 project that saves \$35,000 annually has a three-year payback.
- Life Cycle Costing analysis is a similar calculation, however, it looks at a realistic timeline and includes the maintenance cost savings, the potential increased cost of replacement lamps, and the cost of money, and can only be properly evaluated by considering the cost of money by either the Internal Rate of Return, or the Net Present Value, as discussed below.

Discounted Cash Flow

Discounted cash flow methods recognize the time value of money and at the same time provide for full recovery of investment in depreciable assets.

- The Net Present Value method discounts the stream of annual savings by the company's required return on investment or Cost of Capital.

4 Applications

- The Internal Rate of Return method finds the discount rate, which matches the cash inflows, and the cash outflows leaving a Net Present Value of zero. A company can then make capital investment decisions based on the projects that have the highest Internal Rate of Return; e.g., with interest rates below 10%, a project that delivers an IRR above 10% creates a positive cash flow.

c. Lighting Levels

Light level, or more correctly, Illuminance Level, is easily measured using an illuminance meter. Illuminance is the light energy striking a surface. It is measured in lux (SI) or foot candles (Imperial). The IESNA (Illuminating Engineering Society of North America) publishes tables of recommended illuminance levels for all possible tasks. It is important to realize that the *illuminance level has no relevance to the lighting quality*; in other words, it is entirely possible to have the recommended illuminance in a space but with a light source that produces so much glare that it is impossible to work. This accounts for many of the complaints of either too much or not enough light.

14

d. Light and the Environment

There are a number of methods for determining whether a lighting installation is efficient. One method is for the lighting designer to check with the current version of the ASHRAE/IESNA 90.1 lighting standard. This document, which is revised regularly, provides a recommendation for the Lighting Power Density or watts per square meter or square foot attributable to lighting. It is usually possible for

a capable lighting designer to achieve better results than the ASHRAE/IESNA 90.1 recommendations.

e. Technology Integration

While this handbook is divided into sections dealing with individual lighting technologies, it is essential to realize that the best lighting measures combine technologies to maximize the efficiency of systems. Experienced lighting designers will, for example, select the fluorescent ballast Power Factor, the lamp, and the control system that provide the best possible results for the particular environment and client objectives.

The best solution is derived by matching client requirements with the technology. Therefore, one application may use T-5 technology while another uses metal halide.

f. Case Studies

The following are three case study examples

Case Study One

A School Board Project in Ontario

School boards are usually the owners of their facilities, similar to municipalities, universities, schools and hospitals, i.e., the MUSH sector. In reaction to the baby boom in the mid sixties there was a tremendous expansion in the construction of facilities for this sector. Thus, facility managers have inherited 45-year-old facilities, with much of the infrastructure needing replacement.

4 Applications

This is particularly true for schools. There are limited funds for replacement, so upgrading the systems in these facilities is often the only option.

Lighting systems, just like furnaces, chillers, motors and pumps, are part of the 45-year-old facilities and have a defined life span. Over time, lamp sockets and internal wiring deteriorate, lenses become cracked and broken. Therefore, at some point it is more economical to replace rather than to continue to repair.

Another significant concern for the facility manager is change in use. Computers were unheard of in primary and secondary education when these facilities were constructed, but they are now in common use both in the classroom and for facility management. Curriculums have also evolved, and some facilities, such as science labs, now have very different uses. As a result, there are many classrooms where the lighting technology is out-dated, the equipment is due for replacement, and the light fixtures are no longer appropriate for the illumination of the task.

Lighting technology changes lead to more choice. School gymnasias provide a good example. Older schools may have incandescent, fluorescent or mercury vapour lighting in their gyms. In these facilities 50% or more of the energy in the gymnasium can be saved by redesigning the space with more efficient fluorescent systems using T8 or T5 lamps, combined with occupancy sensors. Some school boards prefer to use metal halide high bay fixtures because fewer fixtures are required, meaning lower maintenance costs. These fixtures can be specified with 'high-low' ballasts combined with occupancy sensors for additional savings.

- Situation:** This project consisted of a survey of 130 building evaluations, including administration, secondary and elementary schools. The challenge in most school board projects is the relatively low hours of building use compared to commercial projects.
- Area:** 5,750,000 square feet
- Action:** A company specializing in the design and delivery of energy programs retained a lighting specialist to help the school board provide a full assessment of savings and costs to achieve a comprehensive energy project.
- Technology:** Existing lighting throughout the 130 buildings consisted of 34 W T12 lamp fluorescent fixtures, some mercury vapour fixtures in gymnasiums, and incandescent exit signs and decorative lighting.
- Solutions:** The design team specified a comprehensive approach including lighting upgrades and redesign, lighting controls, building automation, fuel change, envelope improvements, HVAC upgrades, and solar panels.
- In the classrooms, the fluorescent fixtures were upgraded to T8 fluorescent systems with electronic ballasts, and where appropriate, replaced with new, more efficient fixtures. Where the patterns of use made it economical, occupancy sensors were installed.
 - In the washrooms the existing systems were replaced or retrofit to T8 lamps with

electronic ballasts. Occupancy sensors were installed where appropriate.

- In the gymnasia, most locations received new luminaires, either T8 fluorescent or metal halide high bay fixtures. Occupancy sensors were installed where appropriate.
- In offices, the fluorescent fixtures were upgraded to T8 fluorescent systems with electronic ballasts, and where appropriate, replaced with new, more efficient fixtures. Where the patterns of use made it economical, occupancy sensors were installed.
- Exit signs were replaced with new Light Emitting Diode (LED) exit signs.
- Outdoor lighting systems were upgraded with new controls, using timers and in some cases, photocells, and new luminaires were installed with high pressure sodium lamps.

Results: Total Project Cost: \$12,000,000

Energy Savings: 21.9 million ekWh (equivalent kilowatt hours)

Cost Savings: \$1,500,000 per year
Internal Rate Return greater than 11%.
Note: The owner included other measures that provided better results and still exceeded their hurdle rate.

Measures: Lighting retrofit, fuel change, building automation system, envelope improvements, HVAC upgrades, solar panels.

Case Study Two

A Commercial Building in Downtown Toronto.

Commercial property managers are constantly looking for opportunities to enhance tenant comfort and decrease costs. Lighting is considered a proven technology that meets both objectives.

Commercial buildings commonly use variations on the fluorescent solution. There are a number of issues for the lighting designer to consider. The lighting layout, the arrangement and geometry of light fixtures, may no longer suit the location of work stations. The light levels may be too high for use in computer environments. The light fixtures may have lenses which create reflections on computer screens. The controls are often limited to circuit breakers in an electrical room on each floor. The use of 347 V systems in Canada can also limit the options available to the lighting designer.

A major consideration for building owners and tenants is the disruption caused by a lighting project. Issues requiring substantial cooperation and coordination include:

- access to secure floors or rooms,
- elevator access,
- storage of tools and equipment,
- disposal of packaging materials,
- clean-up at the start and end of each shift.

In order to expedite a project in a timely manner with a minimum of disruption for tenants, skilled project management is required. Obtaining spot energy consumption measurements for both 'pre' and 'post' conditions are recommended.

4 Applications

- Situation:** This project was for a Class A building in Toronto, with 35,000 existing ‘base building’ luminaires.
- Area:** 2,670,000 square feet
- Action:** The building owner hired an engineering firm specializing in energy-efficient systems to provide a cost analysis for retrofitting existing lighting systems with more efficient T8 lighting systems.
- Technology:** Existing base building light fixtures were an inefficient design which used a costly ‘U-Tube’ fluorescent lamp. Each fixture contained 3 lamps and 2 electromagnetic ballasts.
- Solutions:** The lighting designers provided a redesign of the fixture incorporating a reflector, an electronic ballast and linear T8 lamps. On-site testing proved that light level requirements were met and that a savings of 63% of the lighting energy compared to the existing system. This solution also avoided the cost premium of the ‘U-Tube’ lamps.

Other measures undertaken as part of the overall program included boiler replacement, fresh air improvements, and water measures. This project shows the value of integrating measures. For example, 3,500 kW of lighting load was removed from the building, as well as the resulting heat. This created significant cooling savings but also made boiler upgrades essential. Modern, more efficient boilers and

controls replaced the required heat with substantial savings, and provided improvements to indoor air quality.

Results: Project Cost: \$17,000,000

Energy

Savings: 19.4 million ekWh (equivalent kilowatt hours)

Cost Savings: \$1,800,000 per year

Internal Rate Return greater than 10% (Note the owner included other measures that provided better results and still exceeded their hurdle rate.)

The 3,500 kW reduction translated to about a \$1 million annual saving, and the lighting project cost was about \$2.5 million; an internal rate of return of 30%. As is usually the case with these projects, the owner bundled other measures with significantly longer paybacks into this project to maximize the improvements to the building and to better accommodate 'required' system upgrades such as the new boilers.

Case Study Three

Industrial

Situation: An industrial facility in southern Ontario was receiving increased complaints and concerns about existing light levels. Operators were finding poor light levels an increasing concern in certain areas. In addition, there were unusually high maintenance costs due to annual lamp replacements attributed to the plant having a dusty environment.

4 Applications

Action: An industrial lighting designer was retained to tour the facility, interview staff and suggest potential options.

Technology: Typical two lamp 34 W, T-12 open fixture fluorescent fixtures were in use throughout the plant as per the original installation in a standard 'grid' pattern. Although changes had occurred in the plant over the years, the lighting remained the same. Light levels in some areas had deteriorated to as low as 5 foot candles, compared to IESNA recommended 15 foot candles. Staff was concerned and offered to demonstrate the challenges of operating equipment in constraint areas.

Solutions: A three phase solution was proposed and accepted.

22

Phase 1: A short 15 page preliminary assessment was prepared to summarize the data on the existing situation including light levels, estimated lighting fixtures, lamp, ballast and fixture types, as well as recommended options.

Phase 2: Because there were other plants with similar opportunities, it was decided to arrange a tour so staff could see similar industries that had installed, and operated with, the proposed technologies; e.g.,

- Metal halide
- Low pressure sodium
- T-8 fluorescents

Phase 3: A demonstration pilot project was selected for the recommended option to confirm staff acceptance, light levels and recommendations. A design level of 20 foot candles was specified to offset loss of light output due to:

- coefficient of utilization (CU),
- lamp lumen depreciation factor (LLD), and
- luminaire dirt depreciation factor (LDD).

The reflectance in the test area was considered zero because of the dirty environment. There was no prior experience in modeling this type of space due the complexities of the structures and type of work for maintenance, so flexibility was rated very high.

The test area called for 27 metal halide 400 W fixtures and was increased to 32 at the request of plant staff.

The pilot demonstrated a 36% IRR, to exceed the plant internal hurdle rate of 14%. Light levels went from 5 fc to 18 fc and 20 fc in the pilot areas, lamps were reduced from 256 W to 32 W with a 30% energy saving.

Results: Metal Halide 400 W enclosed fixtures were selected and provided the following results:

- 31% energy savings
- 51% fixture and ballast reduction
- 75% reduction in lamps
- four times more light
- 100% client satisfaction with quantity and quality of light!

5 UNDERSTANDING THE THEORY

a. Definition of Light

Definition

- Light is that which makes things visible.
- Light is defined as electromagnetic radiation or energy transmitted through space or a material medium in the form of electromagnetic waves (definition in physics).
- Light is defined as visually evaluated radiant energy – light is that part of the electromagnetic spectrum visible by the human eye (illuminating engineering definition).

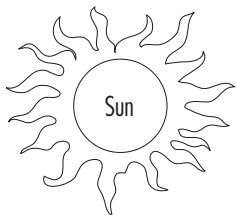

What is Light?



Eye

Electromagnetic Spectrum

- The electromagnetic spectrum is shown in the figure below.
- The visible portion of the spectrum covers a narrow band of wavelength from approximately 380 nm to 770 nm ($1 \text{ nm} = 10^{-9} \text{ m}$). Wavelengths shorter or longer than these do not stimulate the receptors in the human eye.

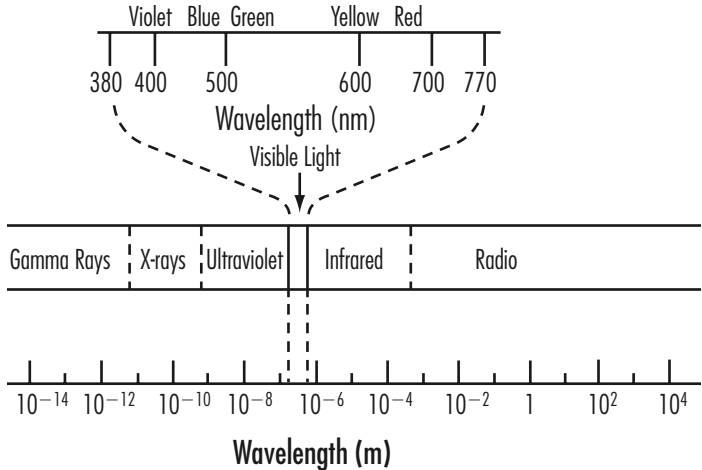

b. Visual Effect of Light

- Light is defined as visually evaluated radiant energy.
- The visible portion of the radiant energy that reaches the eye is absorbed by special receptors (rods and cones) in the retina, which covers the inner wall of the eye.
- In the retina, the rods and cones convert the radiant energy into electrical signals. The nerves transmit the electrical impulses to the brain where the light sensation is created.

Spectral Sensitivity of the Eye

- The sensitivity of the human eye is not uniform over the visible spectrum. Different wavelengths give different colour impressions and different brightness impressions.
- The “relative spectral luminous efficiency curves” (shown on the next page) give the ratio of the sensitivity to each wavelength over the maximum sensitivity.
- The curve for photopic (or day) vision applies when the eye is in bright viewing conditions. The curve is denoted by $V(\lambda)$. The visual response is at maximum at the yellow-green region of the spectrum, at a wavelength of 555 nm.
- The curve for scotopic (or night) vision applies when the eye is in dark-adapted condition. The curve is denoted by $V'(\lambda)$. The visual response is at maximum in the blue-green region of the spectrum, at a wavelength of 507 nm.

Relative Spectral Luminous Efficiency Curves

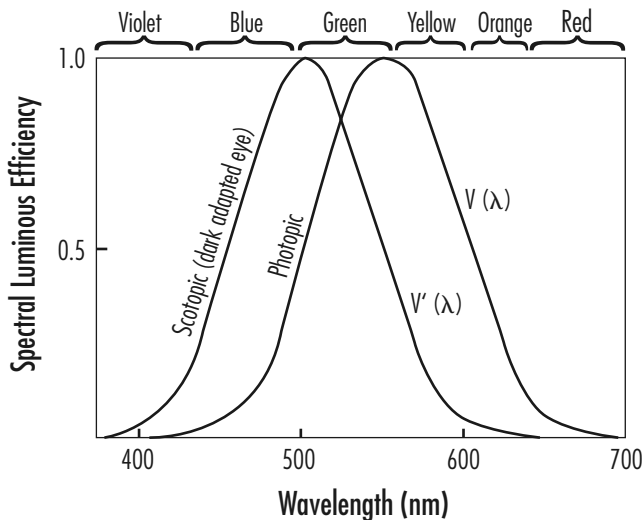

c. Spectral Power Distribution

Introduction

- Each light source is characterized by a spectral power distribution curve or spectrum.

Spectral Power Distribution Curve

- The spectral power distribution (SPD) curve, or spectrum, of a light source shows the radiant power that is emitted by the source at each wavelength, over the electromagnetic spectrum (primarily in the visible region).

5 Understanding the Theory

- With colour temperature and colour rendering index ratings, the SPD curve can provide a complete picture of the colour composition of a lamp's light output.

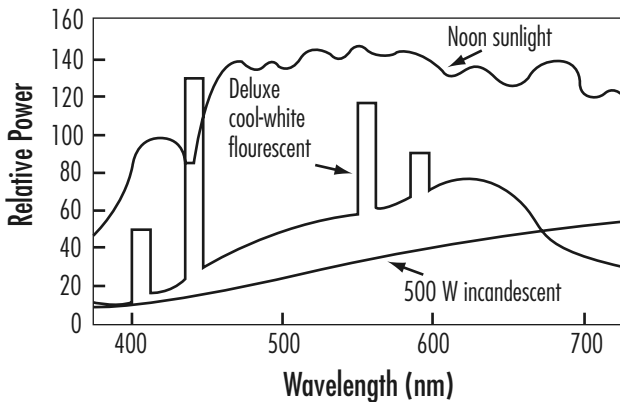

Incandescent Lamp Spectrum

28

- Incandescent lamps and natural light produce a smooth, continuous spectrum.

High Intensity Discharge Lamp Spectrum

- HID lamps produce spectra with discrete lines or bands.

Fluorescent Lamp Spectrum

- Fluorescent lamps produce spectra with a continuous curve and superimposed discrete bands.
- The continuous spectrum results from the halophosphor and rare earth phosphor coating.
- The discrete band or line spectrum results from the mercury discharge.

d. Lighting and Colour

Introduction

- Each wavelength of light gives rise to a certain sensation of colour.
- A light source emitting radiant energy, relatively balanced in all visible wavelengths, such as sunlight, will appear white to the eye.
- Any colour can be imitated by a combination of no less than three suitable primary colours.
- A suitable set of primary colours usually chosen is red, green and blue.
- A beam of white light passing through a prism is dispersed into a colour spectrum.

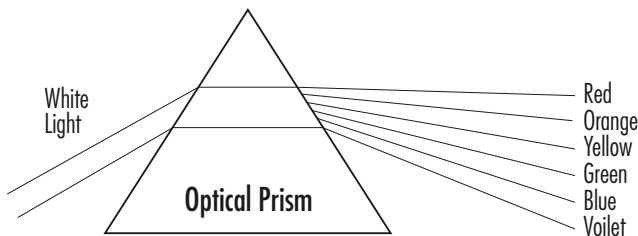

5 Understanding the Theory

Surface Colours

- The perceived colour, or colour appearance, of a surface is the colour of the light reflected from the surface.
- Certain wavelengths are more strongly reflected from a coloured surface than others, which are more strongly absorbed, giving the surface its colour appearance.
- The colour depends on both the spectral reflectance of the surface and the spectral power distribution of the light source. In order to see the colour of the object, that colour must be present in the spectrum of used light source.

Colour Properties of Light Source

- The colour properties of a light source depend on its spectral power distribution.
- The colour properties of a light source are described by three quantities:
 - chromaticity - or colour temperature (CT)
 - colour rendering index
 - efficiency (lumen/watt)

Chromaticity or Colour Temperature

- All objects will emit light if they are heated to a sufficiently high temperature.
- The chromaticity or colour temperature of a light source describes the colour appearance of the source.
- The correlated colour temperature of a light source is the absolute temperature, in Kelvin (K), of a black-body radiator, having the same chromaticity as the light source.

- Sources with low colour temperatures - below 3,000 K have a reddish or yellowish colour, described as warm colour.
- Sources with high colour temperatures - above 4,000 K have a bluish colour, described as cool colour.
- Warm colour is more acceptable at low lighting levels and cool colour at high lighting levels.
- The colour description and application is summarized as follows:
 - below 3,000 K ► warm ► reddish ► lower lighting levels
 - above 4,000 K ► cool ► bluish ► higher lighting levels.

Colour Temperature of Common Light Sources

Light Source	Colour Temp (K)	Description
Sky - extremely blue	25,000	cool
Sky - overcast	6,500	cool
Sunlight at noon	5,000	cool
Fluorescent - cool white	4,100	cool
Metal halide (400 W, clear)	4,300	cool
Fluorescent - warm white	3,000	warm
Incandescent (100 W)	2,900	warm
High Pressure Sodium (400 W, clear)	2,100	warm
Candle flame	1,800	warm
Low pressure sodium	1,740	warm

Colour Rendering Index (CRI)

- Colour rendering is a general expression for the effect of a light source on the colour appearance of objects, compared with the effect produced by a reference or standard light source of the same correlated colour temperature.
- The colour rendering properties of a light source are expressed by the (CRI).
- The CRI is obtained as the mean value of measurements for a set of eight test colours.
- The CRI has a value between 0 and 100.
- A CRI of 100 indicates a light source, which renders colours as well as the reference source.
- The CRI is used to compare light sources of the same chromaticity (or colour temperature).
- The CRI is used as a general indicator of colour rendering: a higher CRI means a better colour rendering.
- It is essential to understand that the CRI value has no reference to 'natural' light, although colours under a high CRI lamp will appear more natural.
- The most important characteristic of a lamp, from an energy viewpoint, is its ability to convert electrical energy into light. This measure is referred to as efficacy, in lumens per watt or light output per watt input. The chart below shows the general range of lumens per watt and the CRI for various light sources.

Colour Rendering Index and Efficacy of Common Light Sources

Category	Lumen/watt	CRI
Incandescent	10 to 35	+95
Mercury Vapour (HID)	20 to 60	20 to 40
Light Emitting Diode	20 to 40	
Fluorescent	40 to 100	60 to 90
Metal Halide (HID)	50 to 110	65 to 90
High Pressure Sodium (HID)	50 to 140	20 to 30 (60)
Low Pressure Sodium	100 to 180	N/A-Low

Colour Rendering Description

CRI	Colour Rendering
75-100	Excellent
60-75	Good
50-60	Fair
0-50	Poor (not suitable for colour critical applications)

Technology and Performance

- Incandescent lamps produce smooth, even SPD curves and outstanding CRI values.
- Halogen versions of incandescent lamps produce whiter light with +95 CRI.
- With gaseous discharge technology, colour characteristics are modified by the mixture of gases and by the use of phosphor coatings.
- HID lamps are chosen mostly for their exceptional energy efficiency; metal halide versions have acceptable CRI levels.

Application Notes

- Warm colour light is associated with indoors, nighttime and heat, and fits better indoors and in cool environments.
- Warm colour light makes warm colour objects (red-yellow colours) look richer.
- Cool colour light is associated with outdoors, daytime and cold, and fits better in warm environments.
- Cool colour light mixes better with daylight (daytime lighting)
- Cool colour light makes cool colour objects (blue-green colours) look refreshing.
- Match light source colour with room objects' colour (interior decoration).
- Sources with high CRI cause the least emphasis or distortion of colour.

e. Lighting Quantities and Units

Luminous Flux or Light Output

- The luminous flux, or light output, is defined as the total quantity of light emitted per second by a light source.
- Sensitivity of the human eye varies, reaching its maximum at a wavelength of 555 nm during daytime (photopic vision) and 507 nm for night vision (scotopic vision)
- The unit of luminous flux is the lumen (lm).
- The lumen is defined as the luminous flux associated with a radiant flux of 1/683 W at a wavelength of 555 nm in air.

- Lamp Lumens (lm) = the quantity of light emitted by a light source.

Luminous Efficacy

- The luminous efficacy of a light source is defined as the ratio of the light output (lumens) to the energy input (watts).
- The efficacy is measured in lumens per watt (lm/W).
- The efficacy of different light sources varies dramatically; from less than 10 lumens per watt, to more than 200 lumens per watt.
- Efficacy of a light source = lamp lumens/lamp watt

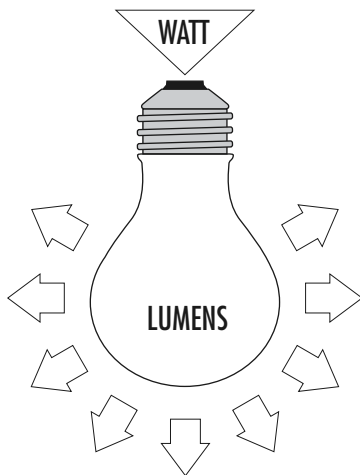

5 Understanding the Theory

Luminous Flux Density or Lighting Level

- The luminous flux density at a point on a surface is defined as the luminous flux per unit area.
 - The luminous flux density is also known as the illuminance, or quantity of light on a surface, or lighting level.
 - The SI unit of the lighting level is the lux (lx),
 $1 \text{ lx} = 1 \text{ lm/m}^2$.
 - When measurement is in Imperial units, the unit for the lighting level is the foot candle (fc): $1 \text{ fc} = 1 \text{ lm/ft}^2$.
 - The relation between the fc and lux is $1 \text{ fc} = 10.76 \text{ lux}$.
Incidentally, this is the same as the relationship between square meters and square feet.: $1 \text{ m}^2 = 10.76 \text{ ft}^2$.
 - The lighting level is measured by a photometer, as shown in the figure below.
- 36
- Minimum recommended lighting levels for different tasks are included below.
 - Lux = the unit of illuminance at a point of a surface.
 - Lux = lumens/area.

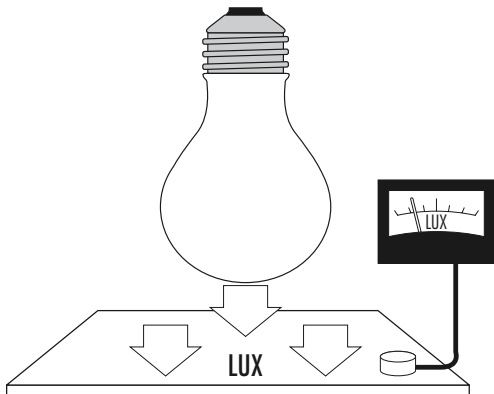

f. Lighting Levels

Introduction

- Recommendations for lighting levels are found in the 9th Edition of the IESNA Lighting Handbook. The Illuminating Engineering Society of North America is the recognized technical authority on illumination.
- The data included in the tables below is approximate and describes typical applications.

Lighting Levels by Visual Task

Type of Visual Task	Lighting Level		Comments
	fc	lux	
Tasks occasionally performed	3	30	Orientation & Simple Visual Tasks
Simple orientation/short visits	5	50	Orientation & Simple Visual Tasks
Working spaces/simple tasks	10	100	Orientation & Simple Visual Tasks
High contrast/large size	30	300	Common Visual Tasks
High contrast/small size or inverse	50	500	Common Visual Tasks
Low contrast/small size	100	1,000	Common Visual Tasks
Tasks near threshold	300-1,000	3,000-10,000	Special Visual Tasks

5 Understanding the Theory

Examples of Lighting Levels by Building Area and Task

Building Area and Task	Lighting Level		Comments
	fc	lux	
Auditoriums	10	100	Include provision for higher levels
Banks - Tellers' Stations	50	500	
Barber Shops	50	500	
Bathrooms	30	300	
Building Entrances (Active)	5	50	
Cashiers	30	300	
Conference Rooms	30	300	Plus task lighting
Corridors	5	50	
Dance Halls	5	50	
Drafting - High Contrast	50	500	
Drafting - Low Contrast	100	1,000	
Elevators	5	50	
Exhibition Halls	10	100	Include provision for higher levels
Floodlighting - Bright Surroundings (Vertical)	5	50	Less for light surfaces – more for dark
Floodlighting - Dark Surroundings (Vertical)	3	30	Less for light surfaces - more for dark
Hospitals - Examination Rooms	50	500	High colour rendition
Hospitals - Operating Rooms	300	3,000	Variable (dimming or switching)
Kitchen	50	500	
Laundry	30	300	
Lobbies	10	100	
Office - General	30	300	
Parking Areas - Covered	2	20	Lower at night
Parking Areas - Open	.2	2	Higher for enhanced security
Reading/Writing	50	500	Varies with task difficulty
Restaurant - Dining	10	100	

5 Understanding the Theory

Lighting Level

Building Area and Task	fc	lux	Comments
Stairways	5	50	
Stores - Sales Area	30	300	
Streetlighting - Highways	0.9	9	Varies with traffic density
Streetlighting - Roadways	0.7	7	Varies with traffic and pedestrian density

Lighting Level Adjustment

Factor	Reduce Lighting Level by 30%	Increase Lighting Level by 30%
Reflectance of task background	Greater than 70%	Less than 70%
Speed or accuracy	Not important	Critical
Workers' age (average)	Under 40	Over 55

6 GENERATION OF LIGHT

a. Light Sources

Introduction

Many different processes convert energy into visible radiation (light).

Some basic processes are described below.

Generation of Light

Incandescence

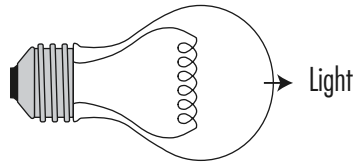

Gas Discharge

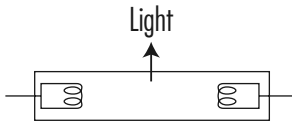

Fluorescence

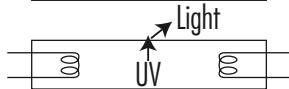

Incandescence

- Solids and liquids emit visible radiation when they are heated to temperatures above 1,000 K.
- The intensity increases and the appearance becomes whiter as the temperature increases.
- This phenomenon is known as incandescence or temperature radiation.
- Application: incandescent lamps.

Luminescence

- Luminescence is the emission of light not ascribed directly to incandescence.
- Two important types of luminescence are electric or gas discharge, and fluorescence.

Electroluminescence

- Electroluminescence is the emission of light when low voltage direct current is applied to a semi-conductor device containing a crystal and a p-n junction.
- The most common electroluminescent device is the LED.

Electric or Gas Discharge

- When an electric current passes through a gas, the atoms and molecules emit radiation, whose spectrum is characteristic of the elements present.
- In low pressure discharge, the gas pressure is approximately 1/100 atm or 0.147 PSI.

6 Generation of Light

- In high pressure discharge, the gas pressure is approximately 1 to 2 atm or 14.7 to 29.4 PSI.
- Application: gas discharge lamps.

Fluorescence

- Radiation at one wavelength is absorbed, usually by a solid, and is re-emitted at a different wavelength.
- When the re-emitted radiation is visible and the emission happens only during the absorption time, the phenomenon is called fluorescence.
- If the emission continues after the excitation, the phenomenon is called phosphorescence.
- In the fluorescent lamp, the ultraviolet radiation resulting from the gas discharge is converted into visible radiation by a phosphor coating on the inside of the tube.
- Application: fluorescent, phosphor-coated HID lamps.

b. Lamp Types

Definition

An electric lamp is a device converting electric energy into light.

Lamp Types by Light Generation Method

- **Incandescent lamps**
- **Gas discharge lamps**
 - Low pressure discharge
 - fluorescent lamps
 - low pressure sodium (LPS) lamps

6 Generation of Light

- High pressure or HID
 - mercury vapour (MV) lamps
 - MH lamps
 - high pressure sodium (HPS) lamps
- Electroluminescent lamps
 - LEDs

Lamp Types by Standard Classification

- Incandescent lamps
- Fluorescent lamps
- HID lamps
 - mercury vapour (MV) lamps
 - metal halide (MH) lamps
 - high pressure sodium (HPS) lamps
- Low pressure sodium (LPS) lamps
- LED sources

6 Generation of Light

Lamp Efficacy or Efficiency

The efficacy of the various types of lamps is shown below:

Lamp Type	Efficacy	
	(Lumens per Watt)	Rated Average Life (hours)
Incandescent	10 to 35	1,000 to 4,000
Mercury Vapour	20 to 60	24,000+
Light Emitting Diode	20 to 40	see below
Fluorescent	40 to 100	6,000 to 24,000
Metal Halide	50 to 110	6,000 to 20,000
High Pressure Sodium	50 to 140	24,000 to 40,000
Low Pressure Sodium	100 to 180	16,000

Rated Average Life

- Rated average life is the total operated hours when 50% of a large group of lamps still survive; it allows for individual lamps to vary considerably from the average.
- Incandescent lamp life can be extended by use of dimming to reduce maximum power.
- Compact fluorescent lamps have relatively long lives of about 10,000 hours.
- Gas discharge lamps have long lives of about 20,000 hours or more.
- LED sources have life based on different criteria. When the LED has lost 50% of its original output, it is considered failed. This is a range from 50,000 to 100,000 hours. This methodology is used by most manufacturers.

c. Lighting Systems

Lighting Unit or Luminaire

A lighting unit consists of:

- a lamp or lamps,
- a ballast (for gas discharge lamps),
- a fixture or housing,
- an internal wiring and sockets,
- a diffuser (louver or lens).

Lighting System

A typical lighting system consists of:

- luminaires,
- lighting control system(s).

Lighting System Environment

A lighting system environment consists of:

- room (ceiling, wall, floor),
- room objects.

6 Generation of Light

Lighting System Illustration

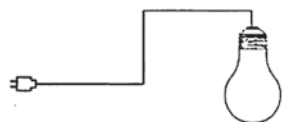

Incandescent lamp



Luminaires

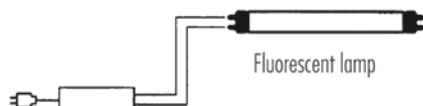

Fluorescent lamp

Ballast



Reflector

46

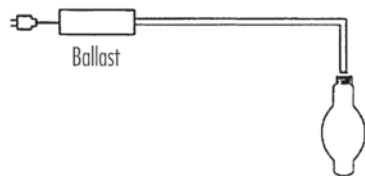

High intensity discharge lamp

Ballast

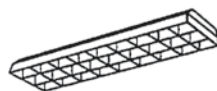

Louver diffuser

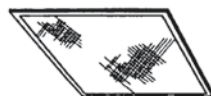

Lens

7 INCANDESCENT LAMPS

a. Standard Incandescent Lamps

Construction

- A typical construction of an incandescent lamp is shown in the figure on the next page.
- An incandescent lamp produces light by using electric current to heat a metallic filament to a high temperature (above 5000°C / 9000°F).
- A tungsten filament is used because of its high melting point and low rate of evaporation at high temperatures.
- The filament is coiled to shorten the overall length and to reduce thermal loss.
- The filament is enclosed in a glass bulb filled with inert gas at low pressure.
- The inert gas permits operation at higher temperatures, compared to vacuum, resulting in a smaller evaporation rate of the filament.
- The bulbs are often frosted on the inside to provide a diffused light instead of the glaring brightness of the unconcealed filament.

7 Incandescent Lamps

Typical Construction of an Incandescent Lamp

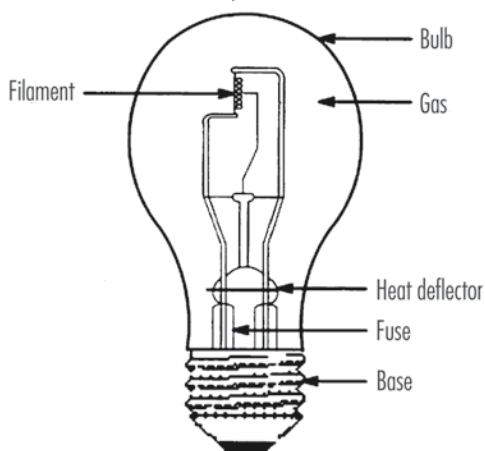

48

Shapes and Designation

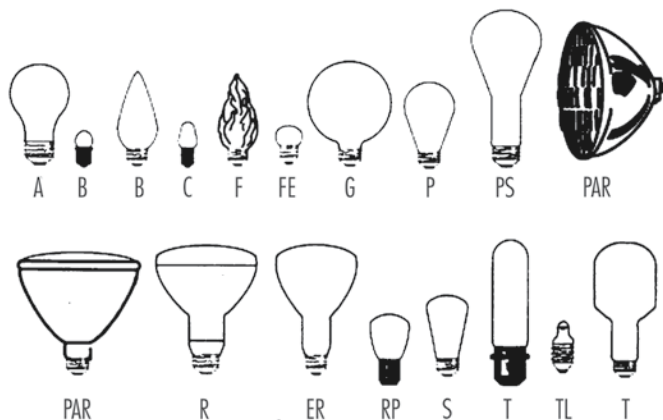

Shape Code

A	Arbitrary (standard)	- universal use for home lighting
B	Bullet	- decorative
BR	Bulging reflector	- for substitution of incandescent R lamps
C	Cone shape	- used mostly for small appliances and indicator lamps
ER	Elliptical reflector	- for substitution of incandescent R lamps
F	Flame	- decorative interior lighting
G	Globe	- ornamental lighting and some floodlights
P	Pear	- standard for streetcar and locomotive headlights
PAR	Parabolic aluminized	- used in spotlights and floodlights reflector
S	Straight	- lower wattage lamps - sign and decorative
T	Tubular	- showcase and appliance lighting

Lamp Designation

A lamp designation consists of a number to indicate the wattage, a shape code and a number to indicate the approximate major diameter.

Example: 60A19

60: Wattage (60 W)

A: Bulb shape

19: Maximum bulb diameter, in eighths of an inch.

7 Incandescent Lamps

Characteristics

Colour rendering index	- 97 (CRI) - excellent CRI
Colour temperature	- 2,500 to 3,000 K - warm colour
Luminous efficacy	- 10 to 35 lumens per watt - lowest efficacy of all light sources - efficacy increases with lamp size
Lamp life (hours)	- 1,000 to 4,000 (typical 1,000) - shortest life of all light sources - longer life lamps have lower efficacy
General	- first developed and most common lamps
Lamp configuration	- point source
Lamp watts	- 1 to 1,500 W
Lamp lumen	- 80% to 90% depreciation factor (LLD)
Warm-up time	- instant
Restrike time	- instant
Lamp cost	- low - lowest initial cost - highest operating cost
Main applications	- residential - merchandising display lighting

More Information:

- Refer to lamp manufacturers' catalogues.

7 Incandescent Lamps

Lamp Designation	Lamp Watts	Rated Lamp Life (hrs)	Initial Lumens	Initial Lumens per Watt	Mean Lumens	Mean Lumens per Watt	Colour Temp Deg K	LLD
Standard								
25 A 19	25	1,000	270	10.8			2,550	0.79
40 A 19	40	1,000	510	12.8			2,650	0.87
60 A 19	60	1,000	855	14.3			2,790	0.93
100 A 19	100	1,000	1,650	16.5	1,535	15.4	2,870	0.90
150 A 23	150	1,000	2,780	18.5	2,585	17.2	2,925	0.89
200 PS 30	200	1,000	3,400	17.0			2,925	0.85
300 PS 30	300	1,000	5,720	19.1	5,205	17.4	3,000	0.82
500 PS 35	500	1,000	10,750	21.5	9,783	19.6	3,050	0.89
1000 PS 52	1,000	1,000	23,100	23.1	21,252	21.3	3,030	0.89
1500 PS 52	1,500	1,000	33,620	22.4	28,241	18.8	3,070	0.78

R Lamps

30 R 20	30	2,000	200	6.7				
50 R 20	50	2,000	320	6.4				
75 R 20	75	2,000	500	6.7				

BR & ER Lamps

50 ER 30	50	2,000	320	6.4				
75 ER 30	75	2,000	580	7.7				
120 ER 40	120	2,000	1,475	12.3				

PAR Lamps

65 PAR 38	65	2,000	765	11.8				
75 PAR 38	75	2,000	1,040	13.9				
120 PAR 38	120	2,000	1,370	11.4				
150 PAR 38	150	2,000	1,740	11.6	1,462	9.7		0.78
200 PAR 46	200	2,000	2,300	11.5				
300 PAR 56	300	2,000	3,840	12.8				
500 PAR 64	500	2,000	6,500	13.0				

Note:

- CRI for incandescent lamps is typically 97.
- The lamp charts throughout this publication are intended for comparison purposes only; please refer to the most recent lamp manufacturer's catalogues or websites for up-to-date information on lamp part numbers and availability.

b. Tungsten Halogen Lamps

Construction

- The quartz tungsten halogen lamp is another type of incandescent lamp.
- The conventional incandescent lamp loses filament material by evaporation which is deposited on the bulb wall, leading to bulb blackening and reduced lamp efficacy during the life of the lamp.
- When a halogen element is added to the filling gas under certain design conditions, a chemical reaction occurs, as a result of which evaporated tungsten is redeposited on the filament, preventing any deposits on the bulb wall.
- The bulb of the tungsten halogen lamp is normally made of quartz glass to withstand the lamp's high-temperature operating conditions.
- The fixture often incorporates a reflector for better heat dissipation and beam control.

Shapes and Designation

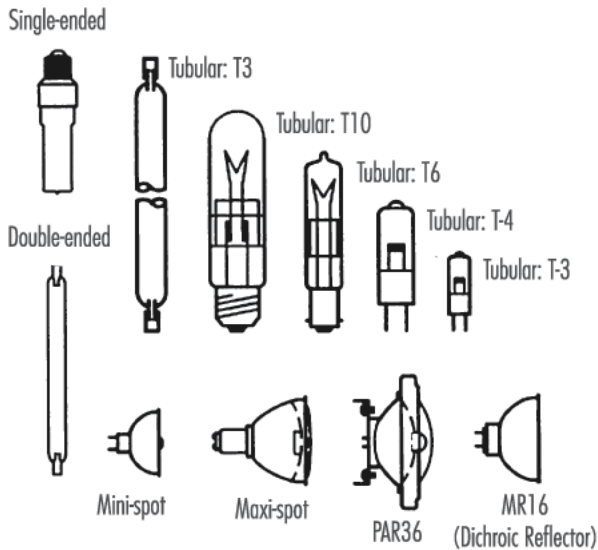

Shape Code

Tubular:T3	Line voltage tungsten halogen lamp - double-ended
Tubular:T10	Line voltage tungsten halogen lamp - single-ended
Tubular:T6	Line voltage tungsten halogen lamp - single-ended
Tubular:T-4	Line voltage tungsten halogen lamp - without reflector
Tubular:T-3	Low voltage tungsten halogen lamp - without reflector
Maxi-spot	Low voltage tungsten halogen lamp - with reflector
Mini-spot	Low voltage tungsten halogen lamp - with reflector
PAR 36	Low voltage tungsten halogen lamp - PAR36 reflector
MR16	Low voltage tungsten halogen lamp - MR16 reflector

7 Incandescent Lamps

Low Voltage Tungsten Halogen

- Operates at low voltage - mainly 12 V,
- Each fixture includes a transformer - supplying the low voltage to the lamp and are compact in size,
- These are more efficient than standard incandescent,
- These have longer life than standard incandescent,
- These are used mainly for display lighting.

Lamp Designation	Lamp Watts	Rated Lamp Life (hrs)	Initial Lumens	Initial Lumens per Watt	Mean Lumens	Mean Lumens per Watt	Colour Temp Deg K	LLD
Single-Ended Quartz								
Q 75CL	75	2,000	1,400	18.7				
Q 100 CL	100	750	1,800	18.0			3,000	
Q 150 CL/DC	150	1,000	2,800	18.7	2,688	17.9	2,850	0.96
Q 250 CL/DC	250	2,000	5,000	20.0	4,850	19.4	2,950	0.97
Q 400 CL/MC	400	2,000	8,250	20.6			2,950	
Q 500 CL/DC	500	2,000	10,450	20.9			2,950	

Double-Ended Quartz

Q 200 T3/CL	200	1,500	3,460	17.3			2,850	0.96
Q 300 T3/CL	300	2,000	5,950	19.8			2,950	0.96
Q 400 T4/CL	400	2,000	7,750	19.4			2,950	0.96
Q 500 T3/CL	550	2,000	11,100	22.2	10,767	21.5	3,000	0.96
Q1000 T6/CL	1,000	2,000	23,400	23.4			3,050	0.96
Q1500 T3/CL	1,500	2,000	35,800	23.9	34,726	23.2	3,050	0.96

Low Voltage MR Types

20MR16FL	20W	4,000	700 CBCP
50MR16FL	50W	4,000	2,000 CBCP
65MR16FL	65W	4,000	2,100 CBCP

- Notes:**
- CRI for incandescent lamps is typically 97.
 - CRI for tungsten halogen (quartz) lamps is slightly better than other incandescent lamps.
 - CBCP = Centre Beam Candle Power, used instead of lumens with the low voltage reflector lamps

- See Also:**
- Lamp manufacturers' catalogues.

c. Halogen PAR Lamps

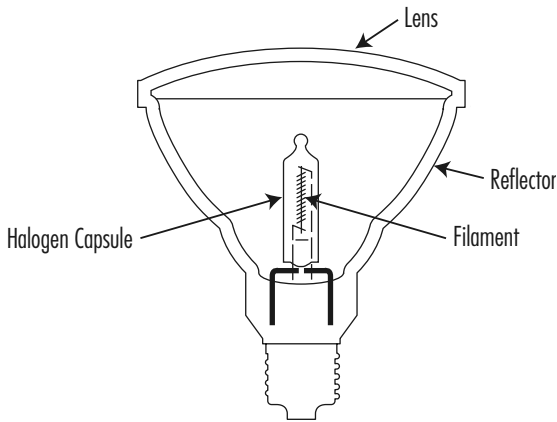

General Description

- Halogen PAR lamps are lamps with a Parabolic Aluminum Reflector (PAR) which use a halogen capsule instead of a simple filament.
- The halogen capsule includes a tungsten filament and halogen gas.

PAR Lamp Families

- PAR lamps have evolved into four families, listed below, from lowest to highest efficiency:
 - standard PAR lamps
 - energy saving PAR lamps
 - halogen PAR lamps
 - Infra Red (IR) halogen PAR lamps.

- All PAR lamps have an aluminum or silver coating reflector on part of the bulb's surface.
- PAR lamps are used for directional lighting, i.e., highlighting or spot lighting.
- Most common size is the PAR38.
- Other sizes include PAR30, PAR20 and PAR16.
- Beam spreads are described as narrow spot (NS), spot (SP) and flood (FL).

Standard PAR Lamps (*see also Section 7a, Incandescent Lamps*)

- Use a tungsten filament but no halogen gas, i.e., no halogen capsule.
- Lamp watts: 75 W, 100 W, 150 W
- Life: 2,000 hours.

Halogen PAR Lamps

- Halogen PAR lamps use a halogen capsule instead of a tungsten filament.
- Lamp watts: 45 W, 65 W, 90 W.
- Life: 2,000 hours.

7 Incandescent Lamps

PAR 38 Lamp Replacements

	Standard PAR	Energy Saving PAR	Halogen PAR	IR Halogen PAR
	75	55,65	45	
	100	80,85	-	-
	150	120	90	60
	-	-	-	100
Life Hours	2,000	2,000	2,000	2,000
Energy	-	20% less	40% less	60% less
Light	-	same	same	same
Colour	-	same	whiter	whiter
GE Brand	PAR	Watt-Miser PAR	Halogen Performance Plus PAR	Halogen IR-PAR
Philips Brand	PAR	Econ-O-PAR	Masterline	-
Sylvania Brand	PAR	Super Saver	Capsylite	-

- Notes:**
- Replacements provide about the same light beam candlepower around the centre of the beam.
 - The standard PAR is used as a basis for the comparisons shown in the table.

Applications

Highlighting merchandise in stores and window displays:

- Downlights,
- Accent lighting,
- Outdoor lighting.

Advantages

Halogen PAR lamps have many advantages over standard and energy saving PAR lamps:

- energy savings in the order of 40% - 60%;
- whiter light;
- constant light output throughout lamp life without lamp darkening.

Limitations

Halogen PAR lamps are more expensive than standard and energy saving PAR.

Assessment

- Halogen PAR lamps provide energy savings which outweigh the lamp price difference in less than a year.
- Halogen PAR lamps provide better quality light.

Lamp Designation	Lamp Watts	Rated Lamp Life (hrs)	Initial Lumens	Initial Lumens per Watt	Mean Lumens	Mean Lumens per Watt	Colour Temp Deg K	LLD
PAR Quartz								
Q90 PAR38	90	2,000	1,740	19.3				0.96
Q150 PAR38	140	4,000	2,000	13.3	1,900	12.7	2,900	
Q250 PAR38	250	6,000	3,220	12.9			2,900	
Q500 PAR56	500	4,000	7,000	14.0			2,950	
Q1000 PAR64	1,000	4,000	19,400	19.4			3,000	

d. Halogen PAR and MR IR (Infrared) Lamps

- Halogen PAR IR lamps use a halogen capsule with an infrared (IR) coating film on the capsule surface.
- The IR film is visually transparent and reflects heat back to the filament, making the lamp more efficient.
- These lamps are the most efficient incandescent PAR lamps.
- Lamp watts: 40 W, 50 W, 55 W, 60 W, 80 W, 100 W, and others.
- Life: 3,000 to 6,000 hours.
- These are an excellent replacement for conventional incandescent PAR lamps.

Standard incandescent PAR Lamp:

150PAR38fl, 2,000 hrs, 1,700 initial lumens, 11.3 lm/W

Halogen PAR Lamp:

120PAR38FL, 2,000 hrs, 1,900 initial lumens, 15.8 lm/W

Halogen HIR PAR Lamp:

90PAR38HIR/FL, 4,000 hrs, 2,030 initial lumens, 22.5 lm/W

e. Infrared Heat Lamps

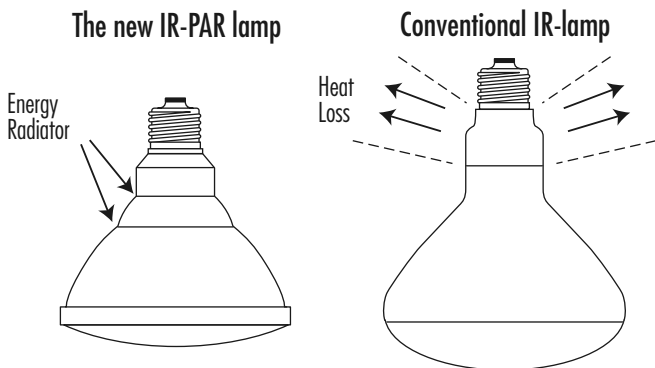

- The Energy Radiator reflects the heat forward
- Skirted PAR lamp base for increased support
- The heat loss in the conventional (Soft Glass) IR lamp

General Description

Infrared heat lamps, also known as IR lamps, or simply heat lamps, are specially-designed incandescent lamps which produce mostly heat and little light.

Types

- There are two basic types:
 - PAR type - i.e., parabolic aluminum reflector lamps
 - R type - i.e., reflector type lamps.

7 Incandescent Lamps

- PAR type lamps are newer and more efficient. They include the following sizes:
 - 175 W PAR 38,
 - 100 W PAR 38.
- R type lamps are older and have been used more extensively. They include the following sizes:
 - 250 W R40,
 - 175 W R40,
 - 150 W R40.
- The 250 W R40 lamp is presently the most widely-used heat lamp in the market.
- Most infrared heat lamps have a red front glass, but lamps with clear white glass are also available.

PAR Lamps Can Replace R Lamps

62

- PAR lamps are newer and more efficient than R lamps.
- PAR lamps can replace higher wattage R lamps with an equivalent heat output.
- Typical replacements:
 - 175 W PAR can replace 250 W R lamp
 - 100 W PAR can replace 175 W and 150 W R lamps
- The parameters used to compare the two types of lamps are listed below.

Technical Data

Lamp Type	Input Wattage (W)	Heat Output (W)	Heat Lamp Efficiency (%)	0 to 30 Heat Output (W)
175 W PAR	175	115	65.7	74
100 W PAR	100	65	65.0	42
250 W R	250	144	57.6	77.5
175 W R	175	95	54.3	46
150 W R	-	-	-	-

- Input wattage is the nominal lamp wattage.
- Heat output is the useful heat available from the front of the lamp i.e., the heat produced in a solid angle of 90° around the lamp axis in the front hemisphere.
- The heat output numbers included in the table above have been measured in a laboratory test.
- Heat lamp efficiency is defined as the ratio of the heat output over the nominal input wattage.
- Heat output in the 0° to 30° zone is the heat output near the centre axis of the lamp.

Lifetimes

- Nominal lifetimes are listed below (manufacturers' data):

Lamp Type	Expected Lifetime(hrs)
175 W PAR	5,000
100 W PAR	5,000
250 W R	5,000
175 W R	5,000
150 W R	5,000

7 Incandescent Lamps

- Lamp life is defined statistically as the time in hours at which 50% of the lamps are still functioning (while 50% have failed).
- The expected lifetime of a single lamp is 5,000 hours, but by definition, the actual lifetime can be higher or lower.
- PAR lamps have a more rugged construction and use a tempered glass not easily broken by thermal shock or mechanical impact.
- In farm applications, typical conditions include high humidity, i.e., RH at least 75% and ammonia levels from 25 to 35 ppm, with an expected negative effect on lamp life.
- Fluctuations in voltage are common in farms and have a negative effect since higher voltages reduce the expected lifetime.
- Monitoring line voltage of a large number of lamps in a real farm setting and recording failure rates would provide a comparison of reliability and lamp life between PAR and R type lamps.

175 W PAR Lamps Can Replace 250 W R Lamps

- The technical data listed on the previous page indicates that the 175 W PAR lamp can be a more efficient replacement for the 250 W R lamp.
- Replacement results in savings of 75 W per lamp, i.e., 30% energy savings.
- Heat output is reduced by 29 W.

- Heat output in the 0° to 30° zone, i.e., heat output near the lamp axis zone, is almost the same for the old and the new lamp (only 3.5 W less).
- The heat lamp efficiency is improved.

100 W PAR Lamps Can Replace 175 W R Lamps

- The 100 W PAR lamp can be a more efficient replacement for the 175 W R lamp.
- Replacement results in savings of 75 W per lamp, i.e., 43% energy savings.
- Heat output is reduced by 30 W.
- Heat output in the 0° to 30° zone, i.e., heat output near the lamp axis zone, is almost the same for the old and the new lamp (only 4 W less).
- The heat lamp efficiency is improved.

Applications

- Farm animal heating;
- In farm animal heating where lamps are on continuously;
- Restaurants also use them for keeping food warm.

Assessment

- PAR heat lamps offer a more efficient and overall better alternative to R type of heat lamps.

8 FLUORESCENT LAMP BALLASTS

a. General

Definition

A ballast is a device used with a gas discharge lamp to provide the necessary starting and operating electrical conditions.

Function

- The ballast supplies the right voltage to start and operate the lamp.
- The ballast limits current to a gas discharge lamp during operation - the resistance of a gas discharge lamp becomes negligible once the arc has been struck.
- The ballast prevents any voltage or current fluctuations caused by the arc discharge from reflecting into the line circuit.
- The ballast compensates for the low power factor characteristic of the arc discharge.

Ballast Construction

- A simple standard ballast is a core and coil assembly.
- The core is made of laminated transformer steel.
- The coil consists of copper or aluminum wire which is wound around the core.

- The core-coil assembly is impregnated with a nonconductor to provide electrical insulation and aid in heat dissipation.
- Capacitors may be included in the ballast circuit to assist in providing sufficient voltage, start the lamp, and/or correct power factor.
- Some ballasts are housed inside the lighting fixture.

Simple Ballast Illustrations

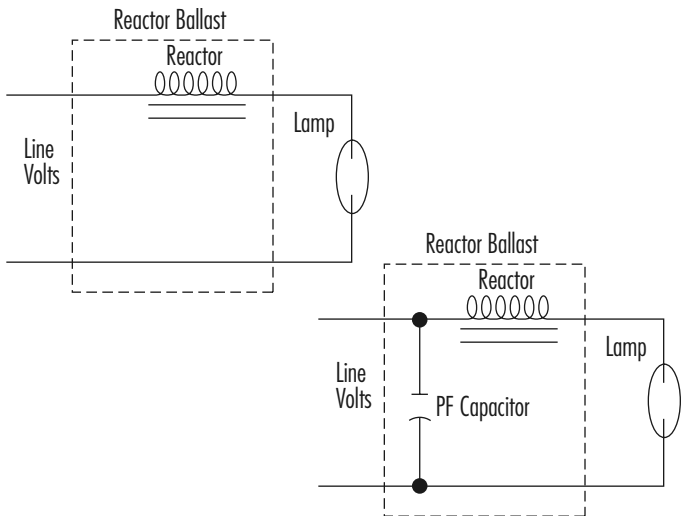

Typical Wiring Diagrams

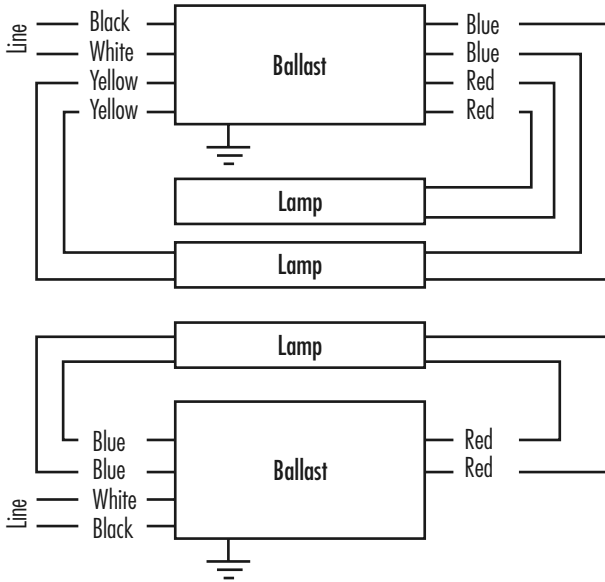

Ballast Losses

- A ballast, as an electric circuit, has electric energy losses.
- Ballast losses are obtained from catalogues of ballast manufacturers.
- Energy efficient ballasts have lower losses.

Types

- Basic types of ballasts based on ballast construction and efficiency are:
 - energy efficient ballasts (core-coil magnetic);
 - electronic ballasts (solid-state);
 - standard magnetic ballast (core-coil design).

- Ballasts are also classified by the type and function of their electric circuit.
- Note that electro-magnetic fluorescent ballasts are gradually being removed from the market place by energy regulations.
- Each ballast is designed to be used with a specific type and size (wattage) of lamp.
- The lamp type and size compatible with the ballast are listed on the ballast label.

Standards

- Ballasts should meet ANSI (American National Standards Institute) specifications for proper lamp performance. The Canadian standard for ballast efficiency is CAN/CSA-C654-M91 *Fluorescent Lamp Ballast Efficacy Measurements*.
- The CBMA (Certified Ballast Manufacturers Association) label indicates that the ballast has been tested and meets ANSI specifications.
- The UL (Underwriters Laboratories) label indicates that the ballast has been tested and meets UL safety criteria (US standard) as well as the Canadian CAN/CSA-C654-M91 criteria.
- The CSA (Canadian Standards Association) label indicates that the ballast has been tested and meets CSA safety criteria.
- Under the North American Free Trade Agreement, both UL and CSA can certify electrical products for sale in both countries.

8 Fluorescent Lamp Ballasts

Thermal Protection

- The NEC (US National Electrical Code) and the Canadian Electrical Code require that all indoor ballasts must be thermally protected.
- This is accomplished by a thermal switch in the ballast which turns power off above a maximum temperature (1050°C approximately).
- Ballasts meeting this standard for protection are designated Class P.
- A cycling ballast, which turns power off and on, indicates an overheating problem.

Sound Ratings

- All core-coil ballasts produce a sound commonly described as a “hum”.
- Manufacturers give the ballasts a sound rating from A to F
- An A ballast produces the least hum, and should be used in quiet areas (offices, homes).
- An F ballast produces the most audible hum, and may be used in places where noise is acceptable (factories, outdoors).

Ballast Life

- Most ballasts are designed for about 50,000 hours under standard conditions.
- If ballast and lamp heat is not dissipated properly ballast life is reduced.
- An 8-10°C increase over rated temperature on the case will cut ballast life in half.
- Ballasts are rated typically for 75°C. 90°C ballasts are a special design called “Extreme Temp”. Some manufacturers list 8°C instead of 10°C.
- Similarly, a 100°C decrease will approximately double ballast life.

b. Electronic Ballasts for Gas Discharge Lamps

71

Typical Circuit Component Diagram

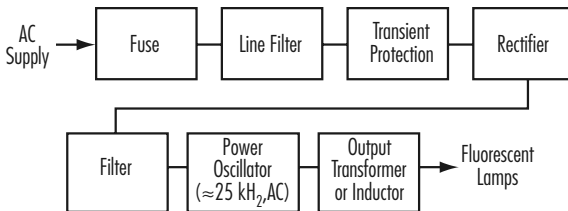

Functional Block Diagram

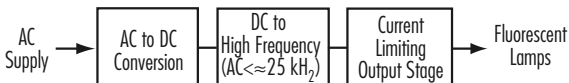

8 Fluorescent Lamp Ballasts

Notes

- Some ballasts have fewer components.
- Some ballasts have components to reduce total harmonic distortion, improve power factor and provide thermal protection.

General Description

- A rapid start ballast starts one or more gas discharge lamps by first heating the electrodes of the lamps to the proper electron emission temperature before initiating the arc.
- An instant start ballast does not preheat the electrodes but initiates the arc by a higher starting voltage.
- A modified start ballast starts the lamp in the same way as the rapid start ballast. It then reduces or cuts off the electrode heating voltage after the lamp arc has stabilized.
- Both types of ballast stabilize the arc by limiting the current to proper levels.
- Older technology (i.e., electromagnetic) ballasts are made of laminated cores wound with copper or aluminum wires; some have capacitors to control voltage and/or to correct power factor.
- Electromagnetic ballasts operate the lamps at line frequency, 60 Hz.
- Electronic ballasts for fluorescent lamps have electronic or solid-state components.
- Electronic ballasts operate the lamps at a high current frequency, typically from 25-50 kHz.

- Electronic ballasts in both the rapid start, instant start and 'program start' modes are available.
- Operation of rapid start lamps by instant start or modified start ballasts can potentially shorten lamp life if combined with other control technologies such as occupancy sensors. Refer to the ballast and lamp manufacturers' data.
- In comparison with the electromagnetic ballast, the electronic ballast weighs less, operates at lower temperatures and at a lower noise level, and is more energy efficient, but costs more.
- It is essential to match the electrical characteristics of both lamps and ballasts.

Technical Data

- Models are available for one-lamp, two-lamp, three-lamp or four-lamp fixtures.
- Available in 120 volts, 277 volts and 347 volts. Some ballasts are now available for universal voltage, i.e., 120 V to 277 V, and less common voltages such as 240 V.
- Ballast specification is based on: number of lamps, lamp type (F32T8/841 or other) and line voltage.
- Example: two-lamp F32T8/841 120V electronic ballast.
- Some electronic ballasts are dimmable.
- The efficacy of electronic ballasts is 21% to 43% better than electromagnetic ballasts.
- Total harmonic distortion (THD) indicates the strength of electromagnetic noise generated.
- Lower ballast temperature means lower electrical losses and a smaller cooling load.

Total Harmonic Distortion

- Harmonics are frequencies that are integral multiples of the fundamental frequency.
- For a 60 Hz fundamental frequency, the second harmonic is 120 Hz, and the third is 180 Hz.
- Harmonics can be present in voltage and/or current.
- Harmonics occur whenever the wave shape is distorted from a pure sine wave.
- Electric utilities supply voltage and current very close to the sinusoidal wave form.
- If the user's load is nonlinear, drawing short pulses of current within each sine wave cycle, the sinusoidal current wave shape will be distorted and a harmonic current will be present.
- The characteristics of the nonlinear load determine the form of the distortion, the magnitude of each harmonic and the corresponding harmonic current.
- Total current is a combination of the fundamental frequency and a contribution from each of the harmonics.
- THD in the current is the root mean square (rms) of all the harmonic currents as a percentage of the fundamental current, and is defined as follows:

$$\text{THD} = \sqrt{\frac{\text{sum of squares of rms magnitudes of all harmonics}^* \times 100\%}{\text{rms magnitude of fundamental}}}$$

* Does not include the fundamental.

- IEEE Standard 519-1981 refers to the Distortion Factor (DF) which equals the THD. However, THD is the preferred term in this guide as it is more descriptive.

- Most electromagnetic ballasts have THD between 18% and 35%.
- Electronic ballasts generate less than 32% THD. Most of them are below 20%. Some are below 10%.
- Due to higher efficiency, the T8 electronic ballast system typically draws 30% less current than the conventional electromagnetic ballast system.

Electromagnetic Interference (EMI) or Radio Frequency Interference (RFI)

- EMI/RFI may cause interference with communication equipment, such as radio, TV, computer.
- Fluorescent lamps energized by electromagnetic or electronic ballasts radiate EMI directly into the air.
- EMI from the lamps may feed back to the line conductors via the ballasts.
- EMI at the electronic ballast fundamental frequency and its harmonics propagate from the ballast's electronic circuits to the line conductors. This EMI may interfere with other electrical equipment on the same distribution network.
- EMI may radiate from the line conductor into the air.
- EMI may be radiated from the high frequency electronic components of the electronic ballast.
- In the US, electronic ballasts must comply with Federal Communications Commission Part 18, Subpart C, Class A for industrial and commercial applications, or Class B for residential applications. As yet no Canadian standard has been set.

8 Fluorescent Lamp Ballasts

Power Factor

- Power factor can be calculated by two methods:
 - wattage (W), voltage (V) and current (I)
 - wattage (W) and reactive power (VAR).
- If calculated correctly – the results should be the same using both methods.
- A low power factor will increase the demand component of your electricity bill for a given lighting load

Rated Average Life

- Ballasts are designed to operate for about 50,000 hours.

Assessment

- Lower ballast operating temperature reduces air-conditioning load.
- The early models had lower reliability than the present ballasts.
- When used with light sensors, dimmable electronic ballasts can reduce the lighting load by providing just the required light level, if other light sources exist.
- Similarly, an energy management and control system uses dimmable ballasts to partially shed the lighting load.

9 FLUORESCENT LAMPS

a. General

Construction

- For typical construction of a fluorescent lamp, see the figure below.
- A fluorescent lamp is a low-pressure mercury electric discharge lamp.
- A fluorescent lamp consists of a glass tube filled with a mixture of argon gas and mercury vapour at low pressure.
- When current flows through the ionized gas between the electrodes, it emits ultraviolet (UV) radiation from the mercury arc.
- The UV radiation is converted to visible light by a fluorescent coating on the inside of the tube.
- The lamp is connected to the power source through a ballast, which provides the necessary starting voltage and operating current.

9 Fluorescent Lamps

Typical Construction of a Linear Fluorescent Lamp

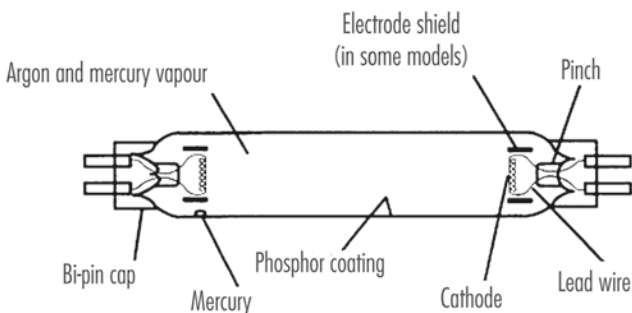

Basic Types of Fluorescent Lamps

- Preheat lamps
- Instant start lamps
- Rapid start lamps

Preheat Lamps

- The cathodes of the lamp are preheated electrically for a few seconds before a high voltage is applied to start the lamp.
- The preheating is accomplished by the use of an automatic switch, called a “starter”, which applies current to the cathodes for sufficient time to heat them.
- The preheat lamps have a bi-pin (double-pin) base at each end.
- Preheat lamps operate normally in a preheat circuit (preheat ballast, starter, lamp and lamp holders).

- Preheat lamps can also be used in rapid start circuits.
- Preheat lamps are not widely used today

Instant Start Lamps

- The instant start lamp requires a high starting voltage, which is supplied by the ballast.
- Since there is no preheating of the cathodes, there is no need for a starter.
- Electrode heating is provided by the arc once it has been established.
- The instant start lamps have a single-pin base at each end of the bulb.
- A few instant start lamps have bi-pin bases, with the pins connected together inside the base.
- Instant start lamps operate normally only in an instant start circuit (instant start ballast, lamp and lamp holders).

Rapid Start Lamps

- The ballast quickly heats the cathodes causing sufficient ionization in the lamp for the arc to strike.
- The cathodes may or may not be continuously heated after lamp starting, depending on ballast design.
- Rapid start lamps start almost instantly (in one or two seconds).
- No starter is required - eliminating the time delay of preheat systems.
- Less voltage is required for starting than with instant start lamps, thus using smaller, more efficient ballasts.

9 Fluorescent Lamps

- The rapid start lamps have a bi-pin (double-pin) base at each end.
- Rapid start lamps can also be used for dimming and flashing applications.
- Rapid start lamps operate normally only in a rapid start circuit (rapid start ballast, lamp, and lamp holders).
- Rapid start lamps are the most widely used fluorescent lamps.

Types of Rapid Start Lamps

- Linear fluorescent lamps – new types, both T8 and T5 sizes
- Linear fluorescents (430 mA for F40) - old types, primarily T12 size
- Energy saving fluorescents, primarily T12 size
- U-shaped fluorescents, in both T8 and T12 sizes
- Circular lamps, in T9 and T5 sizes
- High output lamps, available in T12, T8 and T5 sizes
- Very high output lamps (1500 mA), primarily T12 size
- Lamp diameters range from 5/8" to 2.5"

Shapes

Bi-pin



T-5 miniature bi-pin ($5/8$ " diameter)

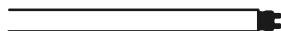

T-8 medium bi-pin (1" diameter)



T-12 medium bi-pin ($1\frac{1}{2}$ " diameter)



T-17 mogul bi-pin ($2\frac{1}{8}$ " diameter)

High Output and Very High Output



T-12 recessed double contact ($1\frac{1}{2}$ " diameter)

Single-Pin

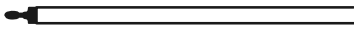

T-6 single-pin ($3/4$ " diameter) SLIMLINE



T-6 single-pin ($3/4$ " diameter) SLIMLINE



T-12 single-pin ($1\frac{1}{2}$ " diameter) SLIMLINE

U-Shape



Medium bi-pin ($1\frac{1}{2}$ " diameter)

Circular

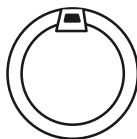

Compact Fluorescent



2-tube
T-4



4-tube
T-4, T-5



Long-tube
T-5

9 Fluorescent Lamps

Lamp Designations

Bi-pin lamps (*preheat, instant start, rapid start*)

Identified by wattage, bulb diameter and colour.

Example: F40T12/CW/ES

- F : Fluorescent lamp
- 40 : Wattage (34 W for ES types)
- T : Tubular bulb shape
- 12 : Maximum tube diameter - in eighths of an inch
($12/8 = 1.5$ ")
- CW : Cool white colour

• Example: F32 T8/41K

- F : Fluorescent lamp
- 32 : Wattage (32 W)
- T : Tubular bulb shape
- 8 : Maximum tube diameter - in eighths of an inch
($8 \times 1/8 = 1$ ")
- 41K : 4,100 K, Cool white colour

Single-pin lamps (*instant start*)

• Identified by length and colour rather than wattage because they can operate at more than one wattage.

• Example: F96T12/WW

- F : Fluorescent lamp
- 96 : Lamp length in inches
- T : Tubular bulb shape
- 12 : Maximum tube diameter - in eighths of an inch
- WW : Warm white colour

Lamp Lengths

Some typical lamp lengths are:

- F20 lamp - 24" (2')
- F30 lamp - 36" (3')
- F32 T8 lamp - 48" (4') – becoming the industry standard lamp
- F40 lamp - 48" (4')
- F96 lamp - 96" (8')

Colour Codes

(e.g., 841 = 80% CRI and 4100 Kelvin)

		CRI	CTT (Kelvin)
C50	: Chroma. 50 (5,000K, CR190+)	90+	5000
C75	: Chroma 75 (7,500K, CR190+)	90+	7500
CW	: Cool White	62	4200
CWX	: Cool White Deluxe	87	4100
D	: Daylight	76	6500
LW	: Lite White	48	4150
N	: Natural	86	3600
SP	: Spectrum Series	70+	varies
SPX	: Spectrum Series Deluxe	80+	varies
WW	: Warm White	52	3000
WWX	: Warm White Deluxe	74	2950
741	: T8 Cool lamp colour	70+	4100
735	: T8 Neutral lamp colour	70+	3500
730	: T8 Warm lamp colour	70+	3000
841	: T5 & T8 Cool lamp colour	85+	4100
835	: T5 & T8 Neutral lamp colour	85+	3500
830	: T5 & T8 Warm lamp colour	85+	3000
Deluxe	: Means better CRI, but with older style T12 lamps, also lower efficacy		

9 Fluorescent Lamps

Lamp Type Code

The lamp type code follows the colour code.

Lamp type codes are listed below.

- IS : Instant Start
- RS : Rapid Start
- HO : High Output
- VHO : Very High Output
- U : U-shaped
- WM : WattMiser (General Electric)
- SS : Super Saver
- EW : Econowatt (Philips)

Characteristics

General - A fluorescent luminaire consists of:
a ballast, usually shared by two lamps,
fixture and lense or louvers

Lamp Configuration - Linear, U-shape, circular or compact

Lamp Watts - 7 W to 215 W

Ballast Watts - varies according to type,
electromagnetic or electronic, and
Ballast Factor

Rated Average Life - 20,000 hours for typical F32T8 lamps
- 24,000 hour T8 lamps are available
- 20-24 times the life of a typical
incandescent

Luminous Efficacy - 40 to 100 lumens per watt

Lamp Lumen - 70% to 90%

Depreciation Factor (LLD)

- Colour Temperature - 2,700 K to 7,500 K
- Wide range of colour temperatures

Index (CRI)

- Colour Rendering - 62 to 94
Warm-up Time - Instant
- Sensitive to extremes of temperature
- Slower than incandescent

- Restrike Time - Immediate

- Lamp Cost - Low
- Energy-saving and energy-efficient lamps more expensive

- Main Applications - Offices, commercial

9 Fluorescent Lamps

Lamp Designation	Lamp Watts	Including 1 Lamp	Ballast (2 Lamp)	Rated Lamp Life (hours)	Initial Lumens	Initial Lumens per Watt	Colour Temp Deg K	CRI
Energy Saving, Rapid Start, Bi-Pin Base F40T12/.... /RS/....EW, SS or WM								
CW	34	47	(81)	20,000	2,775	59.0	4,100	62
CWX	34	47	(81)	20,000	1,925	41.0	4,100	87
WW	34	47	(81)	20,000	2,825	60.1	3,000	52
D	34	47	(81)	20,000	2,350	50.0	6,500	75
LW	34	47	(81)	20,000	2,925	62.2	4,160	48
30U	34	47	(81)	20,000	2,925	62.2	3,000	85
35U	34	47	(81)	20,000	2,925	62.2	3,500	85
41U	34	47	(81)	20,000	2,925	62.2	4,100	85
50U	34	47	(81)	20,000	2,925	62.2	5,000	85
SPEC30	34	47	(81)	20,000	2,925	62.2	3,000	70
SPEC35	34	47	(81)	20,000	2,925	62.2	3,500	73
SPEC41	34	47	(81)	20,000	2,925	62.2	4,100	70

Notes:

- Refer to lamp manufacturers for colours other than shown here.
- Rated Average Life for fluorescent lamps is based on three hours per start.
- Mean Lumens for fluorescent lamps are listed at 40% of lamp life.

See Also

- Lamp manufacturers' catalogues.

9 Fluorescent Lamps

Lamp Designation	Lamp Watts	Including Ballast 1 Lamp (2 Lamp)	Rated Lamp Life (hrs)	Initial Lumens	Initial Lumens per Watt	Mean Lumens	Mean Lumens per Watt	Colour Temp Deg K	CRI	LLD
Compact Fluorescent										
7W +	7	10	10,000	400	40.0			2,700	81	0.80
9W +	9	10	10,000	600	60.0			2,700	81	0.80
13W +	13	17	10,000	900	52.9			2,700	81	0.80
Circline (retrofit for incandescent)										
FCA22/SW +	22	22		10,000	870	39.5				
FCA44/SW +	44	44		7,500	1,750	39.8				
Rapid Start Circline										
FC8/CW/RS + 1	22	27	12,000	1,050	38.9	805	29.8	4,300	62	0.72
FC12/CW/RS +	32	44	12,000	1,800	40.9	1,465	33.3	4,300	62	0.82
FC16/CW/RS +	40	56	12,000	2,500	44.6	1,910	34.1	4,300	62	0.77
Instant Start, 200 milliamp, Single Pin Base										
F72T8/CW	38	55 (100)	7,500	3,100	56.4	2,700	49.1	4,300	62	0.83
F96T8/CW	50	70 (130)	7,500	4,200	60.0	3,860	55.1	4,300	62	0.89
Instant Start, 430 milliamp, Single Pin Base										
F48T12/CW	39	65 (104)	9,000	3,000	46.2	2,760	42.5	4,300	62	0.82
F48T12/LW	30	55 (84)	9,000	2,675	48.6	2,460	44.7	4,100	49	0.82
F72T12/CW	55	80 (150)	12,000	4,600	57.5	4,320	52.9	4,300	62	0.89
F96T12/CW	75	97 (172)	12,000	6,300	64.9	5,800	59.8	4,300	49	0.89
F96T12/LW	60	82 (142)	12,000	6,000	73.2	5,430	66.2	4,100	49	0.89
Rapid Start, 430 milliamp, Bi-pin Base										
F30T12/CW/RS	30	46 (76)	18,000	2,300	50.0	2,010	43.7	4,300	62	0.81
F40T12/.../RS										
cool white	40	53 (93)	20,000	3,150	59.4	2,715	51.2	4,300	62	0.84
cool white deluxe	40	53 (93)	20,000	2,220	41.5	1,800	34.0	4,200	87	0.84
warm white	40	53 (93)	20,000	3,200	60.4	2,715	51.2	3,000	52	0.84
warm white deluxe	40	53 (93)	20,000	2,150	40.6	1,765	33.3	3,100	73	0.84
daylight	40	53 (93)	20,000	2,600	49.1	2,245	42.4	6,500	75	0.84

9 Fluorescent Lamps

Lamp Designation	Lamp Watts	Including Ballast 1 Lamp (2 Lamp)	Rated	Initial	Mean	Mean	Colour	CRI	LLD	
			Lamp Life (hrs)	Lumens	per Watt	Lumens	per Watt			Temp Deg K
lite white	35	48 (83)	20,000	3,050	63.5		4,160	48	0.84	
lite white deluxe	34	47 (81)	20,000	3,050	64.9		4,100	67	0.84	
full spectrum 5000	40	53 (93)	20,000	2,200	41.5	1,850	34.9	5,000	92	0.84
full spectrum 7500	40	53 (93)	20,000	2,000	37.7	1,685	31.8	7,500	94	0.84
prime colour 3000	40	53 (93)	20,000	3,400	64.2			3,000	85	0.84
prime colour 4000	40	53 (93)	20,000	3,400	64.2			4,000	85	0.84

*indicates low power factor ballast only available

Rapid Start T8, Bi-pin Base

F032/730	32	30 (59)	20,000	2,800	93.0	2,520	84.0	3,000	75	0.90
F032/830	32	30 (59)	20,000	2,950	98.0	2,714	90.0	3,000	82	0.92
F032/830 6		30 (59)	24,000	2,900	96.6	2,755	91.8	3,000	85	0.95
F032/830/XP		30 (59)	24,000	3,000	100	2,850	95.0	3,000	85	0.95

High Output Rapid Start, 800 milliamp, Recessed Double Contact Base

F48T12/CW/HO	60	85 (146)	12,000	4,300	50.6	3,740	44.0	4,300	62	0.82
F72T12/CW/HO	85	106 (200)	12,000	6,650	62.7	5,785	54.6	4,300	62	0.82
F96T12/CW/HO	110	140 (252)	12,000	9,200	65.7	8,005	57.2	4,300	62	0.82
F96T12/LW/HO	95	119 (231)	12,000	9,100	76.5	7,915	66.5	4,160	48	0.82
F96T12/LWX/HO	95	119 (231)	12,000	9,100	76.5			4,100	67	0.82

Very High Output Rapid Start, 1500 milliamp, Recessed Double Contact Base

F48T12/CW/VHO	110	146 (252)	10,000	6,250	42.8	4,750	32.5	4,300	62	0.69
F72T12/CW/VHO	165	213 (326)	10,000	9,900	46.5	7,920	37.2	4,300	62	0.72
F96T12/CW/VHO	215	260 (450)	10,000	14,500	55.8	11,600	44.6	4,300	62	0.72
F96PG17/CW	215	260 (450)	12,000	16,000	61.5	12,800	49.2	4,300	62	0.69
F96PG17/LW	185	230 (390)	12,000	14,900	64.8	11,325	49.2	4,160	48	0.69

*indicates low power factor ballast only available

Notes: Some lamps listed here are no longer commercially available, notably the full output F40/CW lamp; they are included here for comparison only.

b. Premium T-8 Lamps

Lamp manufacturers now offer premium grade T-8 lamps for special applications where exceptional colour, longer life and improved lumen output are required.

Standard F32 T-8 Lamp: 20,000 hrs, 82 CRI, 2,950 initial lumens,
98.3 initial lm/W

Premium F32 T-8 Lamp: 30,000 hrs, 86 CRI, 3,100 initial lumens,
103.3 initial lm/W

c. Low-Wattage T-8 Lamps

Lamp manufacturers now offer reduced output or low-wattage T-8 lamps for increased savings on retrofit projects, or for new construction.

Standard F32 T-8 Lamp: 20,000 hrs, 82 CRI, 2,950 initial lumens, up to
80 lm/W depending on ballast

Low-Wattage F28 T-8 Lamp: 24,000 hrs, 82 CRI, 2,562 initial lumens, up to
93 lm/W, depending on ballast

- These lamps have some limitations, for example, they cannot be dimmed, and don't operate in cool temperatures (<60°F)
- Some operate on programmed start ballasts and all operate in instant start ballasts.

d. T-5 and T5-HO Fluorescent Lamps

- Lamp manufacturers now offer T-5 fluorescent lamps in both standard and High Output (HO) versions.
- The smaller diameter tube yields a more compact lumen package, which is easier to control.

9 Fluorescent Lamps

- T-5 fluorescent lamps are available in various lengths and wattages from 14 W to 80 W, and in a circline version in 22 W, 40 W, and 55 W.
- T-5 lamps are nominal length lamps, which means that they cannot be retrofit into fixtures using standard T-12 or T-8 lamps. Therefore, they are generally used for re-design or new construction projects.
- T-5 fluorescent lamps require the use of electronic ballasts and unique sockets.
- T-5 lamps are driving miniaturization and can be used in indirect applications.
- T5-HO is an increasingly popular fluorescent lamp; primarily used in normal to high bay applications, big box retail, warehouse and distribution centres, industrial applications and gymnasiums. T5-HO are also dimmable and operate on instant start ballasts.
- T5 and T5-HO have maximum light output at higher ambient temperatures.

Standard T-5 Lamps:

14 W, 24" (nom), 20,000 hrs, 82 CRI,
1,350 initial lumens

21 W, 36" (nom), 20,000 hrs, 82 CRI, 2,
100 initial lumens

28 W, 48" (nom), 20,000 hrs, 82 CRI,
2,900 initial lumens

35 W, 60" (nom), 20,000 hrs, 82 CRI,
3,650 initial lumens

High Output T-5 Lamps:

24 W, 24" (nom), 20,000 hrs, 82 CRI,
2,000 initial lumens

39 W, 36" (nom), 20,000 hrs, 82 CRI,
3,500 initial lumens

54 W, 48" (nom), 20,000 hrs, 82 CRI,
5,000 initial lumens

e. Fluorescent Fixture Reflectors**General Description**

Fluorescent fixture reflectors are sheets of aluminum placed inside fluorescent fixtures, which divert light directed toward the ceiling down toward the work area.

Illustration

- Illustration of a recessed reflector for a 2' x 4' fixture, with removal of two lamps.

Before installation of the reflector:

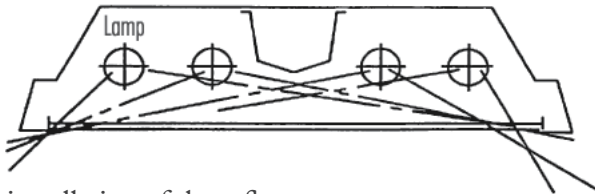

After installation of the reflector:



Physical Data

- There are three basic types of reflectors:
 - **Anodized aluminum or steel reflectors** - in which the surface is painted with a highly reflective electrostatic or powder-epoxy finish.
 - **Anodized aluminum reflectors** - in which the aluminum surface is treated (polished) electrochemically.
 - **Silver film reflectors** - in which a thin film of silver is laminated to an aluminum substrate.
- The reflector finish can be high gloss paint, specular (mirror-like), semi-specular, or diffuse (matt).
- The reflector shape is specially designed to optimize light distribution (custom-designed by the supplier).
- Reflectors are made in the following sizes:
 - **Single reflectors** - 4' or 8' long, one-lamp use
 - **Double reflectors** - 4' or 8' long, two-lamp use
 - **Recessed reflectors** - for 2' x 2' or 2' x 4' fixtures.

Technical Data

- The average total reflectivity for anodized aluminum reflectors is about 90% to 91%.
- The average total reflectivity for silver film reflectors is about 94% to 97%.
- Life expectancy of a silver film reflector is about 15 years.
- Life expectancy of an anodized aluminum reflector is about 20 years.

Applications

- Reflectors are used for lighting energy conservation.
- Reflectors are used for fixture retrofitting or in new energy efficient fixtures.
- A typical application is the installation of a recessed reflector in a 2' x 4' fixture, with removal of two of the four tubes.
- In most instances, it is necessary to re-centre the two remaining lamps in the fixture to avoid dark spots.
- The reflector creates the image of a lamp in the place of the removed lamp; this allows delamping without creating dark spots.
- The light output of a retrofitted fixture with half the lamps removed typically decreases by about 35%, depending on reflector material and design.
- Cleaning and relamping at the same time increases light output by 5% to 20%.

Costs

- Costs depend on the type, size and design of the reflector.

9 Fluorescent Lamps

Advantages

- Reduces lighting power consumption;
- Improves luminous efficacy in the work area;
- Reduces cooling load, in the case of delamping;
- Extends ballast and lamp life by decreasing operating temperature;
- Fewer lamps and fixtures are required;
- Reduces maintenance costs.

Disadvantages

- May have long payback period;
- Not cost-effective if fixtures of different size and type are involved;
- May create a 'cave effect' in some situations, causing walls to appear dark at the top because the light is focused downwards.

Assessment

- Has clear benefits from a lighting efficiency point of view.
- Should be compared to other lighting conservation measures.

f. Compact Fluorescent Lamps

Introduction

- Compact fluorescent lamps are small-size fluorescent lamps.

Types

- There are two general types of lamps:
 - self-ballasted or screw based lamps, for direct replacement of incandescent lamps
 - pin-based lamps for compact fluorescent light fixtures
- They are also available in a large variety of sizes and wattages, and in twin-tube, quad-tube, long tube, twisted, reflectorized and fully enclosed versions.

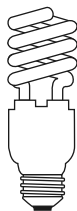

Screw Base
Compact Fluorescent

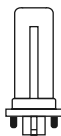

2-tube
T4



4-tube
T4, T5



Long-tube
T5

9 Fluorescent Lamps



Dulux S

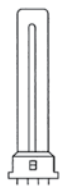

Dulux S/E



Dulux D



Dulux DE



Dulux EL Globe



Dulux EL Reflector

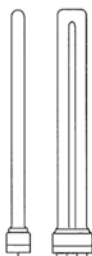

Dulux L



Dulux T



Dulux T/E/IN

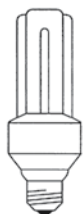

Dulux EL 15, 20 & 23 W



Dulux F

Shapes

Lamp	Magnetic Ballast System Watts	Lumens	Lumens per Watt	Length (mm)	Length (in.)	Colour Temp K	CRI	Life	Base
2-tube or Bi-tube									
5 W	8 W	250	50	105	4 1/8	2700	82	10,000	G23
7 W	10 W	400	57	135	5 5/16	2700	82	10,000	G23
9 W	12 W	600	67	167	6 9/16	2700	82	10,000	G23
13 W	17 W	900	69	178	7 1/2	2700	82	10,000	G23
4-tube or Quad-tube									
10 W	14 W	600	60	108	4 1/4	2700	82	10,000	G24D-1
13 W	17 W	900	69	140	5 5/8	2700	82	10,000	G24D-1
18 W	23 W	1,250	69	170	6 7/8	2700	82	10,000	G24D-2
26 W	32 W	1,800	69	190	7 1/2	2700	82	10,000	G24D-3
Long-tube or High Output									
18 W	25 W	1,250	69	221	8 11/16	2700	82	10,000	2G11
						3000	82	10,000	2G11
						4000	82	10,000	2G11
24 W	32 W	1,900	79	320	12 9/16	2700	82	10,000	2G11
						3000	82	10,000	2G11
						4000	82	10,000	2G11
36 W	48 W	3,000	83	417	16 7/8	2700	82	10,000	2G11
						3000	82	10,000	2G11
						4000	82	10,000	2G11

Self-ballasted Types

Lamp	Watts	Lumens	Lumens per Watt	Life	To Replace
CF7EL	7	280	40	6,000 hrs	25 W chandelier lamp
CF14EL	14	800	57.1	6,000 hrs	60 W A lamp
CF15EL/G	15	700	46.7	6,000 hrs	60 W G lamp
CF20EL	20	1,200	60	6,000 hrs	75 W A lamp
CF20EL/R	20	875	43.8	6,000 hrs	70 W ER lamp
CF23EL	23	1,450	63	6,000 hrs	100 W A lamp

9 Fluorescent Lamps

General Remarks

- The self-ballasted (screw base) lamps are available with incandescent-like features (small size, shape, dimming, 3-way, etc.)
- Compact fluorescent lamps are about four times more efficient than standard incandescent lamps.
- Efficacy or lamp efficiency increases with lamp size and wattage. The smaller size, lower wattage lamps are generally less efficient than the larger size and higher wattage lamps.
- Compact fluorescents have an average life that is 10 times longer than that of standard incandescent lamps, and have a lower maintenance costs.
- They have a high colour rendering index, generally >82, but lower than incandescent lamps.
- They need a ballast to operate, as do all fluorescent lamps.
- Lamps of different manufacturers are interchangeable.
- Maximum overall length
- Most compact fluorescent lamps are available with a variety of colour temperature values, similar to T5 and T8 fluorescent lamps (3,000 K, 3,500 K, 4,100 K).
- There is an Energy Star program for compact fluorescent lamps in North America.

Compact Fluorescent Fixtures

- Many manufacturers produce fixtures for compact fluorescent lamps which include a specially designed ballast and socket (lamp holder). These are available in recessed, outdoor and decorative versions.
- Lamp manufacturers produce retrofit adapters which include the ballast and lamp socket, and have a base to screw directly into a standard incandescent socket (see Self-Ballasted Types, above.).
- Recessed compact fluorescent fixtures should have a properly designed reflector, otherwise light will be trapped inside the fixtures and be wasted.

Two-tube Compact Fluorescent Lamps

- Can be used as replacements for small incandescent lamps.
- Compact fluorescent lamp sizes 5 W, 7 W, 9 W and 13 W can replace incandescent lamp sizes 25 W, 40 W, 50 W and 60 W respectively.
- Compact fluorescent lamps of different wattage rating use slightly different bases and sockets, to eliminate the possibility of plugging a lamp into a fixture with the wrong ballast for that lamp. For example, it is not possible to plug a 13 W lamp into the socket of a fixture with a ballast rated for a 26 W lamp.

9 Fluorescent Lamps

Applications

- Lobby areas, hallways and corridors, any area where there are long hours of use.
- Recessed downlight fixtures.
- Wall and ceiling-mounted fixtures.
- Directional signs.
- Security lighting fixtures.
- Desk and task lighting fixtures.
- Display lighting (museums, stores).
- To replace light bulbs in fixtures which are not readily accessible.

Four-Tube Compact Fluorescent Lamps

100

- Made by combining two two-tube compact fluorescent lamps.
- Also known as double twin-tubes, quad or cluster lamps.
- Same length as two-tube compacts, but double the light output (lumens).
- Four-tube compact fluorescent lamp sizes 9 W, 13 W, 22 W and 28 W can replace incandescent lamp sizes 40 W, 60 W, 75 W and 100 W respectively.

Applications

- Similar to the applications of the two-tube compact fluorescent lamp (see above).
- The four-tube compact fluorescent lamps replace relatively higher wattage incandescent lamps than the two-tube compacts.

Long Tube Compact Fluorescent Lamps

- Longer than the two-tube and four-tube compact fluorescent lamps.
- Can replace standard fluorescent lamps.
- Long tube compact fluorescent lamp sizes 18 W, 24 W and 36 W have the same light output as standard fluorescents F20, F30 and F40 respectively, but are only one third of the length.
- Longer compact fluorescent lamps also feature longer lamp life, up to 20,000 hrs.

10 HID LAMP BALLASTS

a. Ballasts General

Like fluorescent lamps, HID lamps are electric discharge lamps. A ballast is required to provide proper starting and operating voltage and current in order to initiate and sustain the arc.

b. Probe Start Ballasts

The standard core and coil HID ballast or probe start ballast consists of a series of electrical coils on a core of steel laminations. The coils are impregnated with a varnish to provide electrical insulation, reduce noise and dissipate heat. Some ballasts for interior use are housed in metal cans and potted with insulating materials.

102

c. Pulse Start Ballasts

- Pulse start HID Ballasts incorporate a different starting technique which reduces ballast losses and increases lamp performance.
- Pulse start retrofits can be a good measure for existing metal halide installations in schools, industrial and commercial projects.
- A 320 W metal halide pulse start system can replace a 400 W system.
- The pulse start lamp gives less lamp lumen depreciation, better colour consistency over lamp life, and faster hot restrike.

d. Electronic HID Ballasts

Designed primarily for the low wattage Ceramic Metal Halide lamps, the electronic HID ballasts are gradually expanding to higher lamp wattages.

Advantages

- Significantly smaller size and lower weight than core and coil systems.
- More efficient, up to 20% savings over conventional ballasts.
- Square wave output increases lamp life.
- Automatic end-of-life detection; shuts lamp down instead of trying to restart.

11 HID LAMPS & LPS LAMPS

a. Mercury Vapour (MV) Lamps

Note:

Use of MV Lamps should be discouraged. They are no more efficient than fluorescent applications in indoor applications, in outdoor applications they should be replaced with one of the other gas discharge lamps. The disposal of mercury vapour lamps require special methods because of the mercury inside the lamp. Local disposal authorities should be contacted for approved disposal methods.

Construction

104

- The mercury vapour (MV) lamp, or mercury lamp, is a high-intensity discharge (HID) lamp.
- Light is produced by current passing through the mercury vapour at relatively high pressure.
- The MV lamp is the oldest HID source.
- An MV lamp, like all HID lamps, consists of an arc tube enclosed in an outer bulb (a bulb in a bulb).
- The arc tube contains the mercury vapour, a starting gas (argon) and the electrodes.
- The outer bulb contains an inert gas (nitrogen) to prevent oxidation of internal parts and to maintain the operating temperature.
- The outer bulb also provides an inner surface for an optional phosphor coating.

Typical Construction and Circuit of an MV Lamp

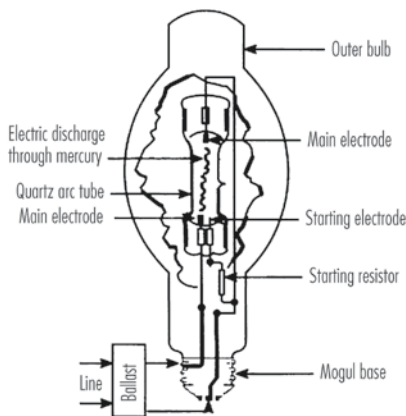

Operation

- When the lamp is turned on, a voltage is applied to initiate an arc between a starting electrode and the nearby main electrode, which vaporizes the mercury.
- The “warm-up” time until the lamp develops full light output is five to seven minutes.
- The “restrike” time (time required to start up after a momentary power interruption) is about 10 minutes.
- During operation, when the electric arc is formed the mercury vapour emits light and ultraviolet (UV) radiation.
- UV radiation can be converted to light by a phosphor coating on the inside of the outer bulb.
- MV lamps, like all HID lamps, require ballasts.

11 HID Lamp & LPS Lamps

Sizes

- Standard MV, 40 to 1,000 watts.
- Self-ballasted MV, 160 to 1,250 watts.

Rated Average Life

- 24,000 hours + for most MV lamps.

Colour

- There are two types of MV lamps, clear and phosphor-coated.
- Clear MV lamps have a bluish-white colour and poor colour rendering.
- Phosphor-coated MV lamps have a better colour appearance and colour rendering.

Efficacy

- MV lamps are the least efficient of all HID lamps.
- MV lamps are more efficient than incandescent lamps, but less efficient than fluorescent lamps.
- Efficacies range from 10 to 63 lumens per watt.

Applications

- MV lamps are no longer specified for new construction or retrofit due to poor efficacy.
- The disposal of mercury vapour lamps will require special disposal methods because of the mercury inside the lamp. Local disposal authorities should be contacted for approved disposal methods
- Interior industrial applications.
- Street lighting, security lighting, floodlighting.
- Retail shops, indoor shopping malls, restaurants, cafeterias, air/bus terminals, lobbies, foyers, gymnasiums, banks, barns.

MV vs Other High Intensity Discharge Lamps

- It may be more economical to replace MV lamps with metal halide or high pressure sodium (HPS) lamps, which have much better luminous efficacy.
- These direct replacement lamps may improve the efficacy by 70%+.
- Refer to chapters on MH lamps and HPS lamps
- MV lamps are rarely used in new lighting systems.

Shapes

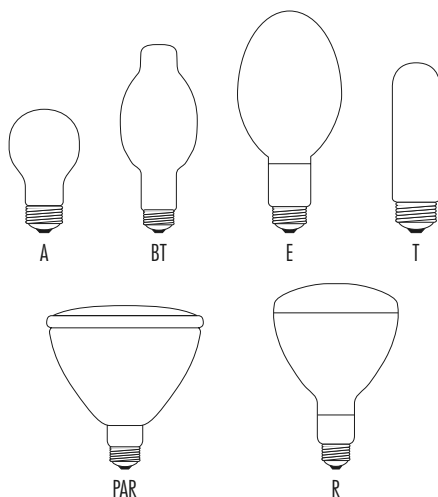

Shape code

A :Arbitrary

BT :Bulged-tubular

E :Elliptical

PAR :Parabolic aluminized reflector

R :Reflector

T :Tubular

Lamp Data

Lamp Designation	Lamp Watts	Including Ballast		Rated Lamp Life (hrs)	Initial Lumens	Initial Lumens per Watt	Lumens Mean Lumens	Mean Colour per Watt	Temp Deg K	CRI	LLD
		Lamp	(2 Lamp)								
Clear											
H43 75	75	95	(190)	24,000	2,800	29.5	2,430	25.6	7,000	22	0.73
H38 100	100	125	(250)	24,000	4,100	32.8	3,380	27.0	7,000	22	0.78
H42 125	125	155	(310)	24,000	5,700	36.8	5,020	32.4	7,000	22	0.88
H39 175	175	210	(410)	24,000	7,900	37.6	7,400	35.2	6,800	22	0.88
H37 250	250	290	(580)	24,000	12,000	41.4	10,800	37.2	5,900	22	0.81
H33 400	400	450	(880)	24,000	20,500	45.6	18,700	41.6	5,900	22	0.84
H35 700	700	775	(1,550)	24,000	41,000	52.9	37,300	48.1	5,900	22	0.81
H36 1000	1,000	1,100	(2,200)	24,000	57,500	52.3	50,600	46.0	5,900	22	0.78
Phosphor Coated											
H46 50/DX	50	63	(125)	16,000	1,575	25.0	1,260	20.0	4,000	43	0.61
H43 75/DX	75	95	(190)	16,000	2,800	29.5	2,250	23.7	4,000	43	0.72
H38 100/DX	100	125	(250)	24,000	4,200	33.6	3,530	28.2	4,000	43	0.70
H42 123/DX	125	155	(310)	24,000	6,350	41.0	5,270	34.0	4,000	43	0.76
H39 175/DX	175	210	(410)	24,000	8,600	41.0	7,650	36.4	4,000	43	0.70
H37 250/DX	250	290	(580)	24,000	13,000	44.8	11,000	37.9	4,000	43	0.62
H33 400/DX	400	450	(880)	24,000	23,000	51.1	18,400	40.9	4,000	43	0.70
H35 700/DX	700	775	(1,550)	24,000	44,500	57.4	34,500	44.5	4,000	43	0.64
H36 1000/DX	1,000	1,100	(2,200)	24,000	63,000	57.3	47,500	43.2	4,000	43	0.65
Self-Ballasted (for replacement of incandescent)											
H160		160	160	12,000	2,300	14.4	1,600	10.0			
H250		250	250	12,000	5,000	20.0	3,750	15.0			
H450		450	450	16,000	9,500	21.1	7,125	15.8			
H750		750	750	16,000	14,000	18.7	10,500	14.0			

- Notes:**
- Mounting for position-oriented lamps is indicated as HOR (horizontal) or VER (vertical) only.
 - When position is unspecified the lumen output value given applies to vertical mounting. Slightly reduced values will result if lamp is mounted in other positions.
 - Life and mean lumen ratings for HID lamps are based on 10 hours per start.
 - H indicates MV lamp (H for Hg - the chemical symbol for mercury).
 - These lamps are being phased out.

b. Metal Halide Lamps

Construction

- The metal halide (MH) lamps are generally similar in construction to the MV lamps.
- They operate on the same principle as all HID lamps.
- The main difference is that the arc tube contains metallic salts (scandium and sodium) in addition to the mercury vapour and argon gas.
- Like all HID sources, MH lamps consist of an arc tube enclosed in an outer bulb.

Typical Construction and Circuit of an MH Lamp

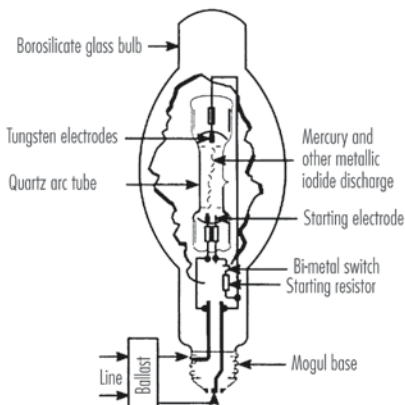

Note: Pulse Start lamp uses higher open circuit voltage for starting.

Operation

- Warm-up time is about 4 minutes.
- Restrike time is about 10-12 minutes standard - 4-7 min. for pulse start.
- MH lamps generally cannot be burnt in any position.
- Horizontal-burning lamps have the arc tube bowed upward, to follow the natural curve of the arc stream in the horizontal burning position.

Available Wattage

- Sizes range from 40 to 1,500 watts.

Rated Average Life

- 6,000 hours (70 W) to 20,000 (400 W).

Colour

- MH lamps are available in both clear and phosphor-coated versions.
- Clear lamps produce a slightly bluish-white colour and have a CRI far superior to MV lamps.
- Phosphor-coated lamps produce a warmer-looking white light and an improved CRI.
- MH lamps exhibit some colour variation from lamp to lamp and normally change colour throughout their life.

11 HID Lamp & LPS Lamps

Efficacy

- The MH lamp is the most efficient source of “white” light available.
- Efficacies range from 50 to 110 lumens per watt.
- MH lamps are more efficient than MV and fluorescent lamps, but less efficient than HPS and low pressure sodium (LPS) lamps.
- CRI - 65-70

Applications

- Similar to MV lamps.
- MH lamps are effective replacements for MV lamps.
- Large wattages are used for floodlighting, streetlighting, large industrial areas and sports arenas.
- Smaller wattages are used in merchandising areas, assembly spaces, schools and public buildings.
- Clear lamps are used for colour TV broadcasting, colour photography, industrial/commercial lighting.
- Phosphor-coated lamps are used for industrial/commercial indoor lighting, area lighting.

Brands

Major manufacturers carry a variety of metal halide lamps.

Shapes

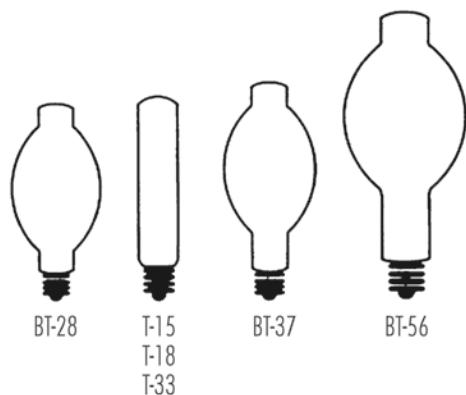

BT :Bulged-tubular

T :Tubular

Numbers indicate maximum diameter in eighths of an inch.

MH Lamps Safety

- Fixtures with MH lamps should be fully enclosed.
- MH and MV lamps operate under high pressure and very high temperatures and there is a possibility that the arc tube may rupture.
- When this happens, the outer bulb surrounding the arc tube may break, and particles of extremely hot quartz (from the arc tube) and glass fragments (from the outer bulb) create a risk of personal injury or fire.

11 HID Lamp & LPS Lamps

- Sylvania and General Electric have issued warnings to the users of their MH lamps.
 - Sylvania's warning:
 - All MH lamps should be used in enclosed fixtures.
 - Enclosures must be made of suitable material, such as tempered glass.
 - General Electric's warning:
 - All MH lamps in horizontal, or more than 15% off-vertical position, should be used in enclosed fixtures.
 - 175 W, 250 W, 1500 W MH lamps, regardless of position, should be used in enclosed fixtures.
 - 325 W, 400 W, 950 W, 1000 W MH lamps, in vertical position, or less than 15% off-vertical position, can be used in open fixtures.
 - In continuously operating systems, turn the lamps off once a week for at least 15 minutes.
 - MH lamps near the end of their life may not start.
 - Relamp fixtures at or before end of rated life.

Direct Replacement of MV Lamps

- Some MH lamps are designed as direct replacements for MV lamps and use the existing MV lamp fixtures and ballasts.
- In comparison with the MV lamps, the efficacy may be improved by 70%+, but the rated average life is generally shorter.
- An energy conservation retrofit.

1 1 HID Lamp & LPS Lamps

Lamp Designation	Lamp Watts	Total Watts Including Ballast		Rated Lamp Life (hrs)	Initial Lumens	Initial Lumens per Watt	Mean Lumens	Mean Lumens per Watt	Colour Temp		
		1 Lamp	(2 Lamp)						K	CRI	LLD
Standard Clear											
M175	175	200		10,000	14,000	70.0	10,800	54.0	4,500	65	0.73
M250	250	275		10,000	20,500	74.5	17,000	61.8	4,700	65	0.72
M400	400	450	(880)	20,000	34,000	75.6	25,600	56.9	4,000	65	0.69
M1000	1,000	1,075	(2,160)	12,000	110,000	102.3	88,000	81.9	4,000	65	0.72
M1500	1,500	1,6200		3,000	155,000	96.3	142,500	88.5	3,900	65	0.88
Standard Phosphor-Coated											
M175/C	175	200		10,000	14,000	70.0	10,200	51.0	3,900	70	0.67
M250/C	250	275		10,000	20,500	74.5	16,000	58.2	3,900	70	0.67
M400/C	400	450	(880)	20,000	34,000	75.6	24,600	54.7	3,700	70	0.63
M1000/C	1,000	1,075	(2,160)	12,000	10,000	102.3	84,000	78.1	3,400	70	0.67
High Performance Clear											
M175/HOR	175	200		10,000	15,000	75.0	12,000	60.0	4,700	65	0.70
M400	400	450	(800)	20,000	40,000	88.9	32,000	71.1	4,500	65	0.71
M1000/VER	1,000	1,075	(2,160)	12,000	125,000	116.3	100,000	93.0	3,500	65	0.72
High Performance Phosphor-Coated											
M175/C/HOR	175	200		10,000	15,000	75.0	11,300	56.5	4,200	70	0.66
M400/C	400	450	(800)	20,000	40,000	88.9	31,000	68.9	3,800	70	0.64
M1000/C/VER	1,000	1,075	(2,160)	12,000	125,000	116.3	95,800	89.1	3,100	70	0.64
MH Operable on Mercury Vapour Ballast											
Clear											
M325	325	375		20,000	28,000	74.7	18,200	48.5	4,000	65	0.57
M400	400	450		15,000	34,000	75.6	20,400	45.3	4,000		0.45
M1000	1,000	1,100		12,000	107,000	97.3	85,600	77.8	3,800		0.75
Phosphor-Coated											
M325/C	325	375		20,000	28,000	74.7	17,600	46.9	3,700	70	0.54
M400/C	400	450		15,000	34,000	75.6	19,600	43.6	3,700		0.45

Notes:

- Mounting for position-oriented lamps is indicated as HOR (horizontal) or VER (vertical) only.
- When position is unspecified the lumen output value given applies to vertical mounting. Slightly reduced values will result if lamp is mounted in other positions.
- Life and mean lumen ratings for HID lamps are based on 10 hours per start.

Ceramic Metal Halide Lamps

General Description

- In order to counter the poor colour consistency of metal halide lamps over life, lamp manufacturers have combined the ceramic arc tube from HPS lamps with the gas mix and metals used in Metal Halide lamps to produce Ceramic Metal Halide (CMH) lamps.
- These lamps offer significant advantages over typical Metal Halide lamps and are available in PAR packages to fit smaller recessed and track-mounted luminaires.
- These sources and luminaires offer significant savings compared to incandescent lamps typically used in retail (stores) and display lighting.

Comparison

116

120 W Halogen PAR 38 Flood:

25°, 3,000 hrs, 7,700 MBCP, 1,800 lm, 95 CRI

39 W CMH PAR 30 Flood (55W with electronic ballast):

30°, 9,000 hrs, 7,400 MBCP, 2,300 lm, 85 CRI

c. High Pressure Sodium Lamps

Construction

- High pressure sodium (HPS) lamps are HID lamps that ionize sodium vapour.
- Like all HID sources, HPS lamps consist of an arc tube enclosed in an outer bulb.
- The arc tube contains xenon (starting gas), sodium and mercury.
- The mercury is in the form of an amalgam with the sodium.
- HPS lamps do not have starting electrodes because of the arc tube's small diameter.
- The arc tube is made of a ceramic that can withstand high temperatures ($1,300^{\circ}\text{C}$) and resist the corrosive effects of hot sodium.

Typical Construction and Circuit of an HPS Lamp

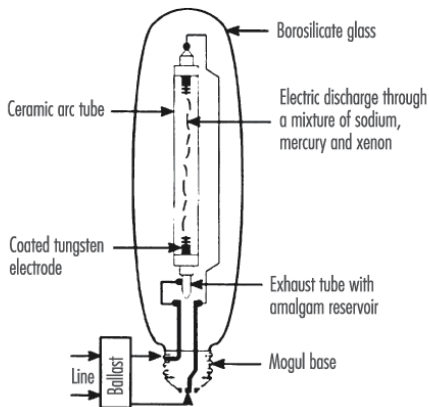

11 HID Lamp & LPS Lamps

Operation

- The ballast provides a high-voltage pulse (2,500 V) for one microsecond for lamp start.
- This high-voltage spike establishes the xenon arc between the main electrodes.
- Mercury and sodium then vaporize rapidly and maintain the arc.
- Warm-up time is three to four minutes.
- Restrike time is about one minute—shortest restrike time of all HID sources.

Sizes

- HPS lamp sizes range from 35 to 1,000 watts.

Rated Average Life

- 24,000 hours for most HPS lamps.

Colour

- The light colour of HPS lamps is usually described as golden-white.
- HPS lamps are available in either clear or diffuse-coated versions.
- Improved colour lamps operating under increased pressure have better colour rendering properties at the expense of lamp life and luminous efficiency.

Efficacy

- HPS lamps are the most efficient source of golden-white light.
- HPS lamps are more efficient than MH lamps, but less efficient than Low Pressure Sodium (LPS) lamps.
- Efficacies range approximately from 50 to 140 lumens per watt.
- Efficacy increases with lamp size.

Applications

- All applications where colour is less important.
- Clear lamps are used in roadway lighting, floodlighting, industrial lighting, area lighting, airport lighting.
- Coated lamps are used in area and floodlighting, security lighting, industrial and commercial indoor lighting and parking lots.

11 HID Lamp & LPS Lamps

Shapes

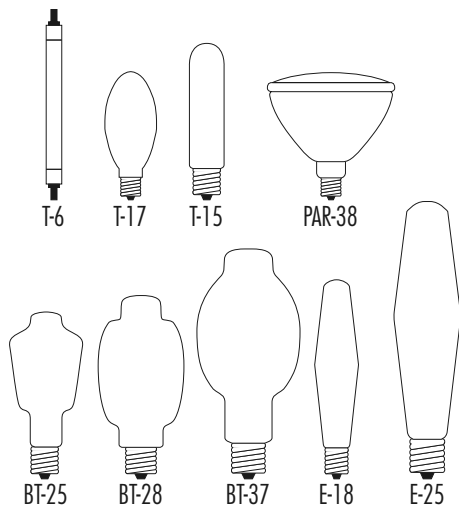

120

Shape Codes

B : Bullet

BT : Bulged-tubular

E : Elliptical

PAR : Parabolic aluminized reflector

T : Tubular

Numbers indicate approximate maximum diameter, in eighths of an inch.

11 HID Lamp & LPS Lamps

Lamp Designation	Lamp Watts	Total Watts Incl.		Rated Lamp Life (hrs)	Initial Lumens	Initial Lumens		Mean Lumens Colour		CRI	LLD
		Ballast	1 Lamp			per Watt	Mean lumen	per Watt	Temp Deg K		
Clear											
S 35	35	55	16,000	2,250	40.9	2,025	36.8	1,900	21	0.84	
S 50	50	70	24,000	4,000	57.1	3,600	51.4	1,900	21	0.81	
S 70	70	95	24,000	5,800	61.1	5,220	54.9	2,100	21	0.83	
S 100	100	130	24,000	9,500	73.1	8,500	65.8	2,100	21	0.79	
S 150	150	190	24,000	16,000	84.2	14,400	75.8	2,050	21	0.84	
S 200	200	250	24,000	22,000	88.0	19,800	79.2	2,100	21	0.84	
S 250	250	305	24,000	27,500	90.2	24,750	81.1	2,100	21	0.84	
S 400	400	475	24,000	50,000	105.3	45,000	94.7	2,100	21	0.86	
S 1000	1,000	1,095	24,000	140,000	127.9	126,000	115.1	2,100	21	0.84	
Diffuse-Coated											
S 35/D	35	55	16,000	2,150	39.1	1,935	35.2	1,900	21	0.84	
S 50/D	50	70	24,000	3,800	54.3	3,420	48.9	1,900	21	0.81	
S 70/D	70	95	24,000	5,400	56.8	4,860	51.2	1,900	21	0.83	
S 100/D	100	130	24,000	8,800	67.7	7,920	60.9	2,100	32	0.83	
S 150/D	150	190	24,000	15,000	78.9	13,500	71.1	2,100	32	0.83	
S 250/D	250	305	24,000	26,000	85.2	23,400	76.7	2,100	32	0.84	
S 400/D	400	475	24,000	47,500	100.0	42,750	90.0	2,100	32	0.80	
Colour Improved Clear											
150	150	190	7,500	13,600	71.6	12,240	64.4	2,400	65	0.27	
200	200	250	7,500	19,000	76.0	17,100	68.4	2,400	65	0.87	
250	250	305	10,000	25,500	82.0	22,500	73.8	2,400	65	0.87	
Colour Improved Diffuse-Coated											
150	150	190	10,000	13,000	68.4		2,300	70	0.89		
250	250	305	10,000	23,000	75.4		2,300	70	0.89		
400	400	475	10,000	39,500	82.1		2,300	70	0.89		

Direct Replacement of MV Lamps

- Some HPS lamps are designed as direct replacements for MV lamps and use the existing MV lamp fixtures and ballasts.
- In comparison with the MV lamps, the efficacy may be improved by 70%+, but the rated average life is generally shorter.
- Often used in energy conservation retrofits.
- For lamp information, refer to the table below:

Lamp Designation	Lamp Watts	Total Watts Including Ballast 1 Lamp	Rated Lamp Life (hrs)	Initial Lumens	Initial Lumens per Watt	Mean Lumens	Mean Lumens per Watt	Colour Temp Deg K	CRI	LLD
HPS Operable on Mercury Vapour Ballast										
Clear										
150	150	180	12,000	13,000	72.2	11,700	65.0	1,800		0.85
215	215	250	12,000	20,000	80.0	18,000	72.0	2,060		0.85
360	360	405	16,000	38,000	93.8	34,960	86.3	2,060		0.88
880	880	930	12,000	102,000	109.7	91,800	98.7	2,100		0.67
Phospho-Coated										
150	150	180	12,000	12,000	66.7	10,800	60.0	1,800		0.85
330	330	380	16,000	30,000	78.9	27,000	71.1	2,000	30	0.73
360	360	405	16,000	36,000	88.9	32,400	80.0	2,060		0.88

- Notes:**
- HPS lamps can be operated in any position without affecting lumen output.
 - Life and mean lumen ratings for HID lamps are based on 10 hours per start.

d. Low Pressure Sodium Lamps

Construction

- Low pressure sodium (LPS or SOX) lamps are HID lamps, operated at low pressure, in which the arc is carried by ionized sodium vapour.
- LPS lamps are more closely related to fluorescent than HID lamps, since they have a low-pressure, low-intensity discharge source and a linear lamp shape.
- An LPS lamp consists of a U-shaped arc tube enclosed in a clear tubular outer bulb.
- An indium oxide coating on the inside of the outer bulb reflects most of the infrared radiation back to the arc tube.
- The arc tube is enclosed in a vacuum to minimize heat loss.
- The lamp is designed to fully utilize its generated heat.
- The arc tube can maintain an operating temperature of about $2,600^{\circ}\text{C}$, resulting in an extremely high luminous efficacy.

Operation

- At start-up, the current is carried by the starting gas (neon and argon) producing a red glow.
- As the lamp warms up, sodium is vaporized and the discharge begins to exhibit the characteristic yellow colour of an LPS lamp.
- Warm-up time is about nine minutes.
- Restrike time is less than one minute.

11 HID Lamp & LPS Lamps

Typical Construction

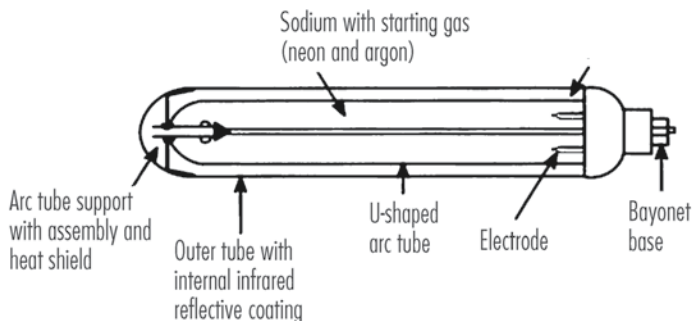

Sizes

LPS lamp sizes range from 18 to 180 watts.

124

Rated Average Life

- SOX 18 - 14,000 hours
- Others - 18,000 hours

Colour

- The light of an LPS lamp has a yellow colour (monochromatic).
- The colour rendition is very low—it turns every colour to either yellow or muddy brown.
- The CRI value does not apply to this lamp.

Efficacy

- The LPS lamp has the highest efficacy of all light sources.
- Lamp efficacies range from 100 to more than 180 lumens per watt.
- Efficacy increases with lamp size.
- The LPS lamp has the highest efficacy because it emits monochromatic yellow light close to the peak of the eye sensitivity curve.

Applications

- The LPS lamp is generally not used in new construction, but it may be found in existing sites.
- All applications where colour rendering is not important
- Roadway lighting
- Security lighting
- Area floodlighting
- Warehouses

Lamp Designation	Total Watts Including Ballast	Rated Lamp Life 1 Lamp	Initial Lumens	Initial Lumens per Lumens	Mean Watt	Mean Lumens per Lumens	Colour Temp Deg K	LLD
SOX 18	18	32	14,000	1,800	56.3	1,800	53.7	1,740 1.03
SOX 35	35	60	18,000	4,800	80.0	4,800	76.2	1,740 1.03
SOX 55	55	80	18,000	8,000	100.0	8,000	95.2	1,740 1.03
SOX 90	90	125	18,000	13,500	108.0	13,500	103.1	1,740 1.03
SOX 135	135	170	18,000	22,500	132.4	22,500	126.4	1,740 1.03
SOX 180	180	215	18,000	33,000	153.5	33,000	146.7	1,740 1.03

- Notes:
- The wattage and lumen output for LPS lamps will increase by approximately 7% and 5% respectively, by the end of lamp life.
 - Due to the monochromatic nature of LPS lamps, CRI is not applicable.

12 OTHER LIGHT SOURCES

a. Inductively Coupled Electrodeless System.

An induction coil is powered by a high frequency generator. The induced current causes acceleration of charged particles inside the lamp bulb. The metal vapour atoms are excited and ionized causing the release of ultra-violet energy. The UV energy causes the phosphor coating on the lamp wall to glow, creating white light.

- These products are seeing gradual implementation, especially in roadway lighting where long lamp life is beneficial.
- Two major lamp manufacturers have products available.
- These products are proprietary and are therefore not interchangeable.
- They require special sockets and electronic control gear.
- Extremely long lamp life, typically 100,000 hours.
- At present still has high cost.
- Icetron from OSRAM/Sylvania

System Watts	System Lumens	Average Rated Life
107	~6280	100,000

- QL Induction Lighting from Philips

System Watts	System Lumens	Average Rated Life
85	6000	100,000

b. Fiber Optic Lighting

In a fiber optic lighting system there are a number of components. The illuminator is the active component, containing either a halogen incandescent or a metal halide light source, a power supply, and some way of collecting the light into a focused beam. The illuminator may also contain a cooling fan to extend lamp life and a colour wheel or other beam modifying system, so that the light intensity, pattern and colour can be changed. The fiber itself is of either glass or plastic construction, and uses the principle of internal reflection to transmit the light down the length of the fiber. The fiber may be end-emitting or side-emitting. End-emitting fiber is used by itself or in conjunction with various lenses to give control of the beam. Side-emitting fiber gives a continuous line of light down the length of the fiber and is used for decorative lighting around buildings and swimming pools.

- Fiber optic lighting is not truly a light source, but a method of transmitting light over a short distance.
- Manufacturers have developed more efficient illuminators using Metal Halide lamps and advanced optical reflector designs.

Applications

- Specialty areas where lamp access is a problem, notably pools and display cases.
- Applications where heat from light sources may be detrimental, such as produce displays in a grocery store.

c. LED Lighting

General Description

An LED (light emitting diode) is an electro-chemical light source. When the diode is forward-biased, light is generated. The light is monochromatic; the colour is dependent on the materials used. White light can be produced by using phosphors similar to those used in fluorescent and coated HID lamps.

Efficacy

The efficacy of LED sources is improving continuously; currently about 30 lm/W is typical.

Life

128

Lamp lumen depreciation in a light source is the gradual reduction in light output over time, caused by normal deterioration of phosphors, cathodes, filaments and the other components of the system. LED systems last up to 100,000 hours, based on the fact that when the light output has depreciated to less than 50% of initial output, then the light source has effectively expired. Life of LED systems is dependent on a number of factors including the colour; red and green LEDs last significantly longer than blue and white LEDs.

Advantages

- Low power consumption and low heat generation.
- Extremely long life.
- Negligible early failures.
- High colour efficiency, because they are monochromatic.
- Very small.
- Resistant to damage from shock and vibration.
- No infra-red or ultra-violet energy is emitted.

Applications

- Typically used in exposed source applications such as signage, decorative festive lighting, marketing displays, and automotive applications
- Traffic signal lamps
- Exit signs
- Seasonal light strings

13 EXIT SIGNS

Physical Data

- Most exit signs are approximately 12" long, 8" high and between 1" and 4" in depth.

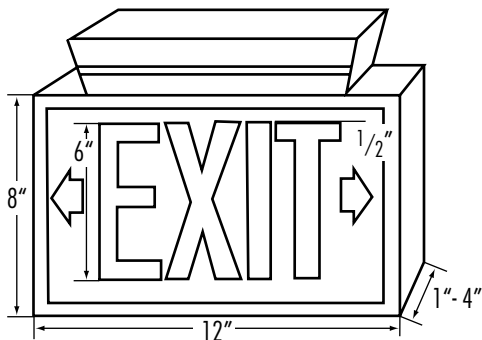

Physical Dimensions of a Typical Exit Sign

Types of Signs

There are two types of exit signs:

- externally lit (rare)
- internally lit (most common).

Externally Lit

- An external light is aimed on the sign.
- Bulb replacement is easy.
- Sign is difficult to see in smoky conditions.
- Power consumption is high (generally incandescent lamps are used).

Internally Lit

- Single- or double-sided sign with light source inside the fixture.
- Some exit signs have an opening fitted with a diffractive lens at the bottom to help light the exit route.

Light Sources of Internally Lit Signs

There are four light sources for internally lit exit signs:

- Incandescent lamps
- Compact fluorescent lamps
- Low-voltage lamps: LED and miniature incandescent lamps
- Tritium gas (Tritium gas signs do not meet current code requirements for brightness of internally lit signs. Consult your lighting designer.)

13 Exit Signs

LED Signs

- LED (light emitting diode) type sign has LEDs in plastic tubes which form the letters.
- These signs use plastic as the medium to transmit the light.
- Require less depth than incandescent and compact fluorescent signs.
- More uniform illumination of letters.
- Manufacturers expect 10- to 15-year lamp life.
- Consumes approximately 2 to 3 watts of power.

Compact Fluorescent Signs

- More expensive than incandescent signs.
- Most incandescent exit signs can be retrofitted with compact fluorescent if there is sufficient space inside the sign to accommodate the lamp and the ballast, although this has become an unusual practice due to the efficiency of LED retrofit units.

132

Compact Fluorescent Lamp Retrofit Lamp

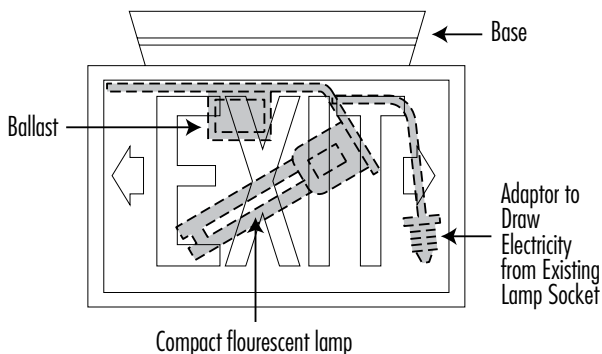

Compact Fluorescent Lamp - Hard-Wired

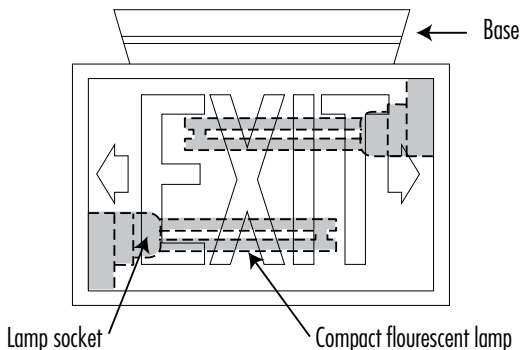

- Compact fluorescent lamps of 5, 7 and 9 watts provide lighting levels similar to incandescent lamps of 25, 40 and 60 watts respectively.
- Lighting of each letter is not uniform.
- Lamp life is generally one to two years.
- Consumes approximately 12 to 20 watts.

Tritium Gas Signs

- Illumination principle is similar to that of a television.
- Radioactive tritium gas undergoes beta decay, releasing an electron which is incident on a phosphor-coated tube, shaped into the word EXIT
- A modern tritium exit sign uses 25 curies (about 2.5 milligrams of tritium in the gaseous form).
- No external energy source required.
- Lamp life is 10 to 20 years; it must then be replaced.
- Highest capital cost for lamp and fixture.

13 Exit Signs

Incandescent Signs

Existing incandescent signs should be immediately replaced because of cost of operation and in commercial and industrial applications cost of maintenance.

- Can no longer be purchased in Canada.
- Incandescent signs usually have two 15 to 25 watt bulbs.
- During a power failure, a sign may be energized by either the emergency power supply system or a 12 V bulb in the middle of the sign powered by a battery.
- Cost varies due to construction features such as vandal-proofing, internal battery etc., and aesthetic features.
- Incandescent signs were the most common type of exit sign in the past.
- Lighting of each letter is not uniform.
- Bulb life is generally one to six months.
- Consumes approximately 30 to 50 watts of power.

Code Requirements

- The National Building Code of Canada requires that:

“Lettering on exit signs shall be:

- (a) red letters on a contrasting background or white letters on a red background, at least 114 mm high with 19 mm stroke spelling EXIT or SORTIE when the sign is internally illuminated, and
- (b) white letters on a red background or red letters on a white background at least 150 mm in height with 19 mm stroke spelling EXIT or SORTIE when the sign is externally illuminated.

“The lighting for exit signs shall:

- (a) be supplied by an electrical circuit that
 - (i) is separate from the other circuits, or
 - (ii) serves other emergency equipment, and
- (b) be connected to an emergency power supply...”

- The National Fire Protection Association of the United States requires the exit signs “... be illuminated by not less than 5 foot candles (54 lx) and shall employ a contrast ratio of not less than 0.5”.

This is not a requirement in Canada.

13 Exit Signs

Assessment

- Incandescents are inexpensive to purchase but expensive to operate and maintain.
- Compact fluorescents can be retrofitted into most incandescent fixtures to reduce energy and maintenance costs.
- LED signs consume less electricity and provide more uniform illumination, as well as being more aesthetically pleasing.
- Tritium gas signs do not consume electricity. The energy comes from the radioactive decay of tritium. They have a high initial cost but require very little maintenance.
- The energy efficiency of Exit Signs are now regulated in Canada and LED technology is the only one able to meet these performance levels.

14 EMERGING TECHNOLOGIES

Reduced Size Sources

- An area of continuing research and development is reducing the size of efficient light sources. Very small, T4.5 39 W ceramic metal halide lamps are presently available, and smaller lamps are being developed.

White Light LEDs

- The LED segment of the market is growing and is believed to be the technology of the future for lighting; efficient, long-life white light LEDs in convenient packages, such as a medium screw base lamp module, could replace traditional incandescent lamps.

Lighting Controls

- While outside the scope of this publication, significant research is being carried out in the area of lighting controls, to allow better and more consistent dimming of sources such as low wattage metal halide, compact fluorescent and LED lamps.

Intelligent Ballasts

The universal adoption of electronic fluorescent ballasts has led to the development of intelligent ballasts incorporating dimming with addressability of individual ballasts. The DALI (Digital Addressable Lighting Interface) protocol allows users and building operators to combine luminaires into control zones in software, thereby eliminating costly rewiring whenever a tenant changes a partition location. In combination with photocells and occupancy sensors, the lighting system becomes a proactive element in the building to optimize the control of illuminance levels.

15 CODES, STANDARDS AND REGULATIONS

Adherence to the appropriate codes and standards is best achieved by following the recommendations of a qualified lighting specialist. There are considerable revisions and changes which will continue to evolve both at the national and provincial/state level. For example, the Canadian Federal Energy Efficiency Act of 1992 provides for the establishment and enforcement of regulations concerning minimum energy performance levels for energy-using products. The act also enforces labeling of energy-using products as well as the collection of data on energy use. These regulations refer to many industry testing and performance standards, and are administered in Canada by Natural Resources Canada (NRCan) www.oeenrcan.gc.ca. These regulations apply to regulated energy-using products imported into Canada or manufactured in Canada and shipped from one Province to another. It is important to consult the acts and regulations which are enforced in your jurisdiction.

There is also the Energy Policy Act of 1992, an amendment to the Energy Policy & Conservation Act that was passed in 1975. It included provisions for utilities to invest in conservation and energy efficiency, as well as funding for establishing energy efficient lighting and building centers. There are further enhancements expected that have resulted from the realization and support for energy efficiency.

Code for Buildings

Similarly, it is important to remain current on local and regional requirements. There are often references to national codes or standards, but may also be enhanced requirements.

Examples of national efforts include:

- Residential buildings: Council of American Building Officials (CABO) Model Energy Code.
- Commercial Buildings: ASHRAE/IESNA standard 90.1-2004.
- Guide to Canada's Energy Efficiency Regulations - Natural Resources Canada, 1999.

16 WORKSHEETS

LIGHTING COST AND SAVING ANALYSIS

a. An Audit Data Worksheet

PROJECT SUMMARY

Project:	Project Manager:
Site:	Project Engineer:
Report:	Lighting Specialist:
Total Area (sq.ft.):	Lighting Designer:
Date of Report:	Regional Office:
Rev.:	
Project No.:	
Building No.:	

COST AND SAVINGS ANALYSIS

Existing Electrical Use - (Base Year Electrical Data):

Annual Electrical Demand - Peak Average:	(kW)
Annual Electrical Consumption:	(kWh)
Annual Hours of Use (Average):	(hrs.)
Annual Electrical Cost:	(\$/sq.ft.)

Electrical Rates Information

	Blended Rates	Summer	Winter
Demand Charge (kW) - (\$)			
Consumption Charge (kWh) - (\$)			

Lighting Energy Savings Summary

	Demand (kW)	Electrical Consumption (kWh)	Cost	Cost/sq.ft.
Current Usage	0.0	0	\$0	
Proposed Retrofit	0.0	0	\$0	
Savings	0.0	0	\$0	

Lighting Cost and Savings Summary

Item	Cost	Cost/sq.ft.
Outside Materials Cost	\$0	<i>[Calculated + Adjustments]</i>
Outside Labour Cost	\$0	<i>[Calculated + Adjustments]</i>
Total Outside Cost	\$0	<i>[Sum Above 2]</i>
Outside Service Markup (17.0%)	\$0	<i>[Cost Multi. + % Noted - Calc. Cost/sq.ft.]</i>
Rose Technology Labour (15%)	\$0	<i>[Cost Multi. + % Noted - Calc. Cost/sq.ft.]</i>
Subtotal	\$0	<i>[Sum Above 3]</i>
Guarantee (0.0%)	\$0	<i>[Cost Multi. + % Noted - Calc. Cost/sq.ft.]</i>
GRAND TOTAL - COSTS	\$0	<i>[Sum Above 2]</i>
Lamp & Ballast Savings	\$0	<i>[User Entry + Calc. Cost/sq.ft.]</i>
Utility Incentive	\$0	<i>[User Entry + Calc. Cost/sq.ft.]</i>
Annual Savings	\$0	<i>[From Above + Calc. Cost/sq.ft.]</i>
GRAND TOTAL - SAVINGS	\$0	
Simple Payback (years)		<i>[Total Cost/Total Savings]</i>

PROJECT NOTES

- NOTES:** (a) Standard voltage (120 V) and lamps (34 W/40 W) existing. *[User entry]*
- (b) Demand charge and consumption rate see chart below. *[User entry]*
- (c) Handling of P.C.B. ballasts not included in project cost. *[User entry]*
- (d) Asbestos content taken into account. *[User entry]*
- (e) Highlighted areas represent altered design due to asbestos conditions. *[User entry]*
- (f) *[User entry]*
- (g) *[User entry]*

b. A Measures/Savings Worksheet

ENERGY BALANCE

Existing Energy Balance

	Demand (kW)	Electrical Consumption (kWh)	Cost	Cost/sq.ft.
Lighting	0.0	0	\$0	<i>[As Above]</i>
Plugload	0.0	0	\$0	<i>[User Entry]</i>
Mech. Measures	0.0	0	\$0	<i>[User Entry]</i>
TOTAL	0.0	0	\$0	

PROJECT ADJUSTMENTS

Material Adj.:	(1)	Lift/Scaffold:	<i>[Material Adj. Table]</i>	\$0.00
	(2)	Trailer Storage:	<i>[Material Adj. Table]</i>	\$0.00
	(3)	Disposal Bin:	<i>[Material Adj. Table]</i>	\$0.00
	(4)	Travel:	<i>[Material Adj. Table]</i>	\$0.00
	(5)	Electrical Inspection Cert.:	<i>[Material Adj. Table]</i>	\$0.00
	(6)	Handling of PCB ballasts:	<i>[Material Adj. Table]</i>	\$0.00
	(7)	Lamp Disposal:	<i>[Material Adj. Table]</i>	\$0.00
	(8)			\$0.00
Material Adjustment Total:				\$0.00 <i>[Sum Material Adj.]</i>
Labour Adj.:	(1)	Patching & Painting	<i>[Labour Adj. Table]</i>	\$0.00
	(2)			\$0.00
	(3)			\$0.00
Labour Adjustment Total:				\$0.00 <i>[Sum Material Adj.]</i>

17 BIBLIOGRAPHY

- Lighting Reference Guide, Seventh Revision, January 2002
- Rae, Mark S., ed. The IESNA Lighting Handbook, Reference & Application, 9th edition, New York, NY, IESNA, 2000
- General Electric Catalogues.
- Philips Lighting Catalogues.
- OSRAM/Sylvania Lighting Catalogues.

Websites:

<http://www.gelighting.com/na/>

<http://www.nam.lighting.philips.com/can/>

<http://www.sylvania.com/HomeAlternate.htm>

<http://www.venturelighting.com/>

18 GLOSSARY OF TERMS

ballast

- a device used with a gas discharge lamp to provide the necessary starting and operating electrical conditions.

candela (cd)

- the fundamental unit from which all other lighting units are derived. Candlepower, the intensity of light in a specified direction, is measured in candelas. An ordinary wax candle has a candlepower of about one candela.
- candelas are used to compare intensities of different kinds of directional light sources. In a 75 W spotlight lamp the centre of beam is 1,730 candelas and in a 75 W floodlight lamp it is 430 candelas, i.e., the centre of the spotlight's beam is four times as intense as the floodlight's.

diffuser

- a device commonly put on the bottom and/or sides of a luminaire to redirect or scatter the light from a source.

diffusion

- the scattering of light that falls on a surface.

efficacy

- the ratio of total lumens produced by the light source to the watts consumed by the source, expressed in lumens per watt.

efficiency

- the ratio of the total lumens emitted by the luminaire to those emitted by the lamp, expressed as a percentage.

electromagnetic spectrum

- the total range of wavelengths of frequencies of electromagnetic radiation. The visible portion covers a wavelength from approximately 380 nm to 780 nm ($1 \text{ nm} = 10^{-9}\text{m}$).

foot candle (fc)

- the practical working unit for the measurement of lighting level equal to one lumen falling uniformly on an area of one square foot.

illuminance

- luminous flux density or lumens per unit area incident on a surface. The unit of illuminance is the lux (lx) where
 $1 \text{ lx} = 1 \text{ lm/m}^2$ (SI units) or the foot candle (fc) where
 $1 \text{ fc} = 1 \text{ lm/ft}^2$ (Imperial units). The relationship between lux and foot candle is $1 \text{ fc} = 10.76 \text{ lx}$.

Illuminating Engineering Society of North America (IESNA)

- the recognized technical authority in the illumination field in North America

lamp

- a generic term for an electric source of light. A lamp usually consists of a light-generating element (arc tube or filament), support hardware, enclosing envelope and base.

light

- any radiation which makes things visible. It is radiant electromagnetic energy capable of exciting the retina of the eye and producing a visual sensation.

lumen (lm)

- the unit of luminous flux, i.e., the quantity of light emitted by a lamp. 1 lumen = 1 candela, x 1 steradian.

luminaire

- a complete lighting unit consisting of a lamp(s) and parts designed to distribute the light, to position and protect the lamp(s) and to connect the lamp(s) to the power supply.

luminance

- the luminous intensity of a surface in a given direction per unit of projected area. The unit for luminance is NIT = candela/m² or foot-lambert = π candela/ft². A surface emitting or reflecting light in a given direction at a rate of one candela per square meter of projected area has a luminance in that direction of 1 cd/m² or 1 NIT.

luminous exitance

- the light leaving a surface at a point is measured in lumens per square foot.

lux (lx)

- a unit of illuminance or lighting level equal to one lumen uniformly falling on an area of one square meter.

photometer (light meter)

- an instrument for measuring photometric quantities such as illuminance (in foot candles or lux). The light sensitive cell, typically a selenium cell, must be cosine corrected and $V\lambda$ corrected.

reflectance

- the ratio of light emitted from a surface to the light falling on that surface.

refraction

- the bending of light rays as they pass through clear glass or plastic.

specular surfaces

- surfaces from which the reflection is predominantly regular, e.g., highly polished or mirror finished surfaces.

transmittance

- the ratio of light transmitted through a light-passing material (e.g. glass or ceramics) to the incident light falling on that material.

19 INDEX

- 30 Chromaticity
- 30 Colour Rendering index
- 30 Colour Temperature
- 30 Correlated Colour Temperature
- 24 Electromagnetic Spectrum
- 68 Electronic Ballast, Fluorescent Lamps
- 41 Fluorescence
- 146 Illuminance
- 138 Illuminance Levels
- 41 Incandescence
- 42 Lamp
- 24 Light, Definition
- 34 Lumen
- 41 Luminescence
- 35 Luminous Efficacy
- 36 Luminous Flux Density
- 36 Photometer
- 34 Photopic Vision
- 29 Primary Colours
- 44 Rated Average Life
- 27 Relative Spectral Luminous Efficiency Curves
- 34 Scotopic Vision
- 27 Spectral Power Distribution
- 36 Unit of Illuminance

Notes:

Your feedback and comments are appreciated. Please provide suggestions to:

info@ceatech.ca



Printed on recycled paper.

Energy Efficiency is Good Business

- Economic Prosperity
- Environmental Performance
- Social Responsibility
- Security



Natural Resources
Canada

Ressources naturelles
Canada

