

FICHE DE VÉRIFICATION

Inspection régulière

Centre de ravitaillement - Armoire de rangement

Loi sur le bâtiment (L.R.Q., c.B-1.1)





N° intervention



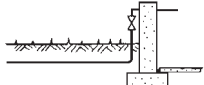

Gaz

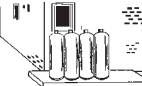

Chapitre II et III

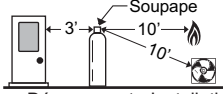
Normes: B149.1-05
B149.2-05 Z662-03



1- Alimentation	
 Générateur de secours 6.25.1, 6.25.2	1
Gaz naturel	
Emplacement Compteur et régulateur (B149) 4.6.1, (Z662) 12.4.10 Évent (Z662) 12.4.10.6	2
Branchement d'immeubles Peinture 9.3.1 Protection 12.4.10.4 Compteur régulateur 12.4.10, (B149.1)4.6.1	3
 Robinet d'arrêt 12.2.1, 12.2.2, 12.2.3	4
Gaz propane	
 A tous les 10 ans Réinspection et remarque des bouteilles 6.1.1	5
 No CRN: Pression 250 lb/po ² 7.1.1	6
Remplissage Volume 80% - Poids 42% Tableaux: 6.1 et 6.2 bouteilles Tableaux: 7.1 et 7.2 réservoirs 7.7.1 et 7.7.2 réservoirs	7
 Soupape de décharge en contact avec la phase gazeuse 6.1.7	8
 Bouteille interdite à l'intérieur Utilisation et entreposage 6.5.1.2, 6.5.1.3	9
 Installation 10' entre chaque système Limite de 4 bouteilles 6.7.7	10

1- Alimentation (suite)	
Dégagements	
 Dégagement - Installation 6.7.2	11
 Installation de réservoir Tableau 7.4 art. 7.10.2 Dégagements 5.3.3, 7.1.5, 7.1.8, 7.12.4.	12
Matériel électrique Tableau 7.6 7.19.5.	
 Vaporisateur 9.1, 9.2	14
 Interdit 6.7.4	15

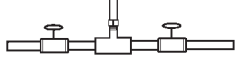
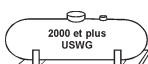
2- Accessoires (propane)	
 Capuchon de la soupape de décharge 7.2.5	1
 Clapets limiteurs de débit et clapets anti-retour 7.4	2
 Soupape de décharge hydrostatique 5.4.2, 5.6.1, 5.8.1 et 5.8.2	3
 Manomètres des réservoirs 7.5.1	4

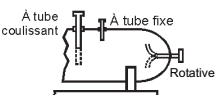
2- Accessoires (suite)	
 Jauges des réservoirs 7.6.1	5

3- Protection	
 Peinture (corrosion) Bouteilles 6.1.5 Réservoirs 7.1.4	1

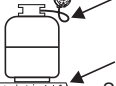
 Tuyau de raccordement souple Base solide Socle et raccord 6.7.1	2
---	---

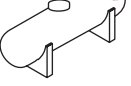
 Supports des réservoirs 7.11	3
---	---

 Protection contre les véhicules Bouteille 6.7.6 Réservoir 7.1.14	4
---	---

4- Contrôle pression	
 Pression à l'intérieur des bâtiments Tableau 5.1 (art. 5.1.1) (Propane) Système 2lb/po ² 5.2.2.4 (Naturel) Système 2 lb/po ² 5.2.3. Robinet d'arrêt 5.2.1.5	1

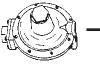
 Ventilée à l'extérieur ou limiteur de fuite Soupape de décharge Intégrée ou non 5.6.1.3 5.5	2
--	---

 Installation 5.2.1.5 - Fixation 5.2.2.1 Protection - Fixation 5.4.2	3
--	---

 Dégagement des événements Tableau 5.2	4
--	---

C.C. = Code de construction
C.S. = Code de sécurité
r. = D-10,r.4

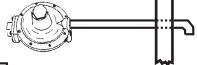
4- Contrôle pression(suite)	
 Tuyauterie d'évent extérieur Grille 5.5.6 Évent 5.5.10 Grille et pluie 5.8.2	5

 Ensemble régulateur à double détente 5.2.2.2	6
--	---

5- Tuyauterie	
Acier Cuivre Autre Matériaux approuvés 6.2	1

 Diamètre 6.3	2
--	---

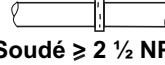
 Soudé ≥ 2 1/2 NPS Joints des tuyaux 6.9.2	3
---	---

 Emplacement Endroits interdits 6.7.2	4
---	---

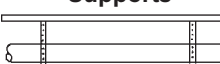
 Supports 6.8.3 - Toiture 6.26	5
---	---



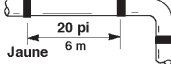

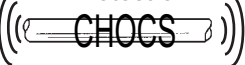
 Peinture Corrosion 6.16.1	6
--	---

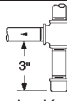

 Identification 20 pi Jaune 6 m	7
---	---

 Protection CHOC Protection - Fixations 6.16.3	8
--	---

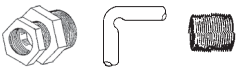
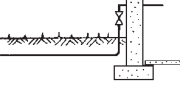
☐ = Centre de ravitaillement



Défauts (notes explicatives)

5- Tuyauterie(Prop et nat)(suite)	
 Siphon de dégorgement 6.13	9
B-149.1	
 Sortie d'alimentation 6.12.1	10
B-149.1	
 Pratiques interdites 6.14.2, 6.14.5, 6.14.7	11
B-149.1	
 Sortie du sol 6.15.8	12
B-149.1	
 Tuyaux de raccordement Min. 2' Max. 6'	13
Norme CGA 6.10 (fixe) 6.16 (mobile) 6.21	
B-149.1	
 Tuyaux souples	14
B-149.1 6.20	5.9 B-149.2

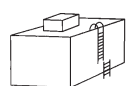
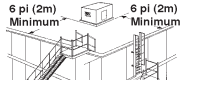

6- Divers	
CGA, CSA, ULC, WH, Régie 	1
C. C. Approbation 2.04, 2.05	
Approuvé pour l'usage auquel il est destiné	2
C. C. 2.04	
Pour chaque appareil	3
Robinet d'arrêt manuel 6.18.2	
B-149.1	
Instructions du fabricant 	4
Tuyauterie - Appareils - Accessoires - Évacuation 4.1.3	
B-149.1	B-149.2
DANGER Fuite de gaz et appareils à risque 4.5.2	5
B-149.1	



7- Divers (suite)	
Protection chocs Appareils 4.23	6
B-149.1	
 Accès permanent 4.14.5	7
B-149.1	
 Dégagements 4.14.6	8
B-149.1	

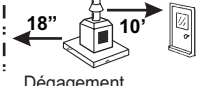



7- Chaudière	
 Plancher incombustible 7.1.1, 7.1.2	1
B-149.1	
PLAQUE SIGNALÉTIQUE	2
Dégagements-Matériaux combustible 7.1.3	
B-149.1	

8- Chauffe-eau	
 Installation 7.26.1	1
B-149.1	
 Soupape de décharge 7.26.2	2
B-149.1	
PLAQUE SIGNALÉTIQUE	3
Dégagements- Matériaux combustible 7.26.4, 7.26.5	
B-149.1	

9- Chauffe-piscine	
 Installation 7.25.1 - 7.25.6 4.15.3	1
B-149.1	
 Dégagement 7.25.2	2
B-149.1	
Dégagement du conduit d'évacuation: 8.14.10 de la ligne de propriété: 7.25.3	
B-149.1	

10- Aérotherme	
 Supports 7.27.1	1
B-149.1	
 Dégagement 7.27.4	2
B-149.1	
 Protection si moins de 8 pieds 7.27.3	

11- Chauffage radiant	
 Ventilateur	1
B-149.1	
Non ventilé 7.22.1, 7.22.2, 7.22.4 a)	
 Interrupteur	
 Ventilé 7.22.3, 7.22.4 b)	2
B-149.1	

12- Cuisinières, friteuses grilloirs, app. de comptoir Commercial	
PLAQUE SIGNALÉTIQUE	1
Dégagements - Matériaux combustible 7.10, 7.31.2, 7.31.3, 7.31.5	
B-149.1	
 Dégagements 7.31.6	2
B-149.1	
 Dispositif fixe et incombustible 6 po (150 mm)	3
B-149.1	
Mur combustible Dispositif de retenue	
Appareils montés sur roues 6.21.5, 7.31.4	
 EXTINCTION D'INCENDIE	4
B-149.1	
Système automatique 4.19	
 Table de cuisson Raccordé par un tuyau rigide 7.28.1 Interdit dans une chambre à coucher 7.28.2	5
B-149.1	
PLAQUE SIGNALÉTIQUE	6
Dégagements - Matériaux combustible 7.28.3	
B-149.1	

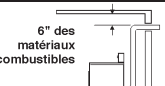
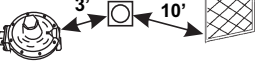
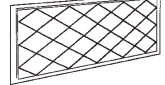
13- Sécheuse	
PLAQUE SIGNALÉTIQUE	1
Dégagements - Matériaux combustible 7.4.2, 7.5.4	
B-149.1	
 Évacuation 7.4.7, 7.5.1	2
B-149.1	
 Conduit d'évacuation 7.4.3, 7.4.4, 7.5.2	3
B-149.1	
 Approvisionnement d'air 7.4.6	4
B-149.1	

14- Appareils à ventouse - Foyer	
Interdit salle de bain-chambre à coucher sauf à ventouse	1
Installation 7.11, 7.24	
B-149.1	
PLAQUE SIGNALÉTIQUE	2
Dégagements - Matériaux combustible 7.24.1	
B-149.1	

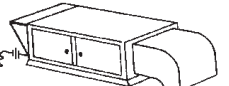
15- Générateur (GVTC)	
 Installation 7.20	1
B-149.1	

16- Générateur d'air chaud chauffage central	
 Base solide	1
Installation et dégagements 7.13, 7.13.3, 7.136	
B-149.1	

17- Générateur d'air chaud horizontal	
PLAQUE SIGNALÉTIQUE	1
Dégagements - Matériaux combustible 7.16.4	
B-149.1	

Défauts (notes explicatives)

18- Générateur d'air chaud à gaines

Interdit dans la même pièce

1

Panneaux amovibles
Air de circulation Dégagements

B-149.1 7.15, 7.15.3 7.15.6

19- Cuisinière domestique

PLAQUE SIGNALÉTIQUE

1

Dégagements - Matériaux combustible

B-149.1 7.32

20- Appareils d'éclairage

1

Dégagements

B-149.1 7.30.3

21- Réfrigérateur

PLAQUE SIGNALÉTIQUE

1

Dégagements - Matériaux combustible

B-149.1 7.33.1

VÉRIFICATION

2

Combustion

B-149.1 4.5.2

Installation dans logement (Endroit pour dormir)

3

B-149.1 7.33.2

Non ventilé dans un endroit à usage d'habitation accessible au public Installer un détecteur de CO

4

Avant le 25 mai 1995
r. 2.10, 24.10

Non ventilé dans un endroit à usage d'habitation accessible au public Détecteur de CO intégré

5

À partir du 25 mai 1995
r. 2.9, 24.9

22- Moteur fixe

1

Installation

B-149.1 7.34, 7.35

23- Appr. air appareil débit calo. égal ou inf. 400 000 Btu/h

Dimensions des ouvertures

1

Exception: air pris à l'intérieur voir Code de construction

B-149.1 8.2

Appareils comportant un échangeur de type tubes à ailettes

2

B-149.1 8.2.1

24- Appr. air appareil débit calo. sup. 400 000 Btu/h

Dimensions des ouvertures

1

Air de ventilation: 8.4.1
Approvisionnement d'air: 8.4.2, 8.4.3, 8.4.4

B-149.1

Registre ou persienne automatique

2

Registre manuel interdit: 8.5.3

B-149.1 Entrebarrage: 8.5.4

Ventilateur

3

Interrupteur

Détecteur de courant d'air

B-149.1 8.8.1

25- Système d'évacuation

Conduit de raccordement

1

Fixation

B-149.1 8.18.15, 8.9.3

Dépression, supports

B-149.1 8.15, 8.18.17, 8.18.20

Dégagements des matières combustibles

2

Tableaux : 8.6 et 8.7

B-149.1 8.18.9 à 8.18.13

Mur combustible Scellé à l'entrée

3

B-149.1 8.18.12

"B" ou "L"

4

Espace non chauffé

B-149.1 8.18.21, 8.18.23

S1 S S2

5

$S = S1 + S2$

Diamètre

B-149.1 8.18.4 à 8.18.8

Conduit de raccordement

6

Épaisseur du conduit

B-149.1 8.18.1, 8.18.2, 8.18.3,

Coupe-tirage

7

Vertical Horizontal

Registre 8.26

B-149.1 8.23, 8.28.1

Prolong. au-dessus du coupe-tirage

8

B-149.1 8.14.6

Dispositifs interdits

9

B-149.1 8.22, 8.27

Cheminée et conduit d'évacuation

10

REFOULEMENT

Evacuation de tous les gaz

B-149.1 8.10.1, 8.10.7, 8.24.6

Conduit d'évacuation

11

Cheminée

Chemisage 8.12.2, 8.12.8, 8.12.10

B-149.1 Évacuation 8.9.1, 8.10.2

Système d'évacuation conforme au tableau 8.5

12

B-149.1 8.10.3, 8.11, 8.12

Pression positive

13

Évacuateur mécanique

Pression positive

B-149.1 8.24.3, 8.10.6

Cheminée Voir annexe C Catégorie 1

14

Dimensions

B-149.1 8.13.1, 8.13.2

Dénivellation des ouvertures

15

B-149.1 8.12.6, 8.16

Adaptateurs certifiés

16

Cheminée

Supports

B-149.1 8.15

Cheminée et conduit d'évacuation

Conduit type B

17

Interdit avec appareil non certifié et appareil sans coupe-tirage

B-149.1 8.10.7

Extrémité de la cheminée: Extr. du conduit d'évacuation:

18

B-149.1 8.14.4, 8.14.2, 8.14.5

INTERDIT

19

Extrémité du conduit d'évacuation

B-149.1 8.14.12

Dégagements

20

Extrémité du conduit d'évacuation

B-149.1 8.14.8

Capuchon sur la sortie d'évacuation

21

B-149.1 8.14.11

26- Évacuation particulière

1

Pression négative causé par un ventilateur

B-149.1 8.6, 8.10.5

Hotte

2

B-149.1 8.24.4, 8.30

Dégagements appareil à ventouse

3

B-149.1 7.11

Système d'évacuation particulier









4

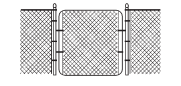





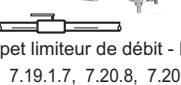
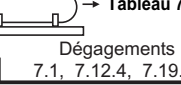
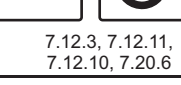



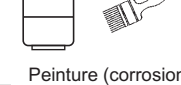
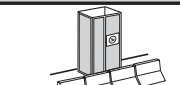

B-149.1 8.24.2, 8.24.4, 8.29.1

27- Autre

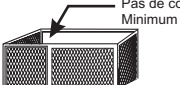
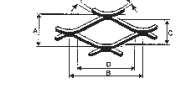
1

Défectuosités (notes explicatives)

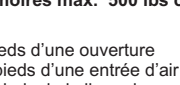
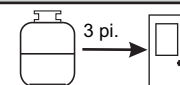
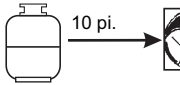
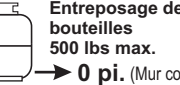
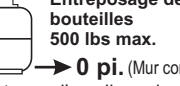
28- Centre de ravitaillement	
 Date d'émission C. S. 74	1
 Entreposage des récipients B-149.2 7.19.1.2	2
 Cabinet Enceinte Clôture Verrouillage B-149.2 7.19.1.4, 7.19.2	3
 20 - B,C. Extincteur B-149.2 7.19.1.6	4
 3,5 pi (1 m) 10 pi (3 m) Réservoir Protection B-149.2 7.19.4.3	5
 Commande de sûreté manuelle B-149.2 7.4.4, 7.12.13, 7.19.3.1b), 7.20.4	6
 Dégagements des dispositifs de distribution B-149.2 7.19.1.9, 7.20.1, 7.20.7	7
 Protection des dispositifs de distribution B-149.2 7.20.2, 7.20.3	8
 Clapet limiteur de débit - Robinet B-149.2 7.19.1.7, 7.20.8, 7.20.9, 7.20.10	9
 Installation de réservoir Tableau 7.5 Dégagements B-149.2 7.1, 7.12.4, 7.19.1.1.	10
 AFFICHE 7.12.3, 7.12.11, 7.12.10, 7.20.6	11
 Raccord à plus de 5 pi. B-149.2 7.1.11	12

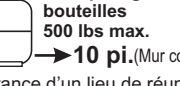
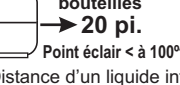
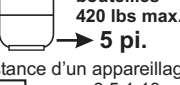
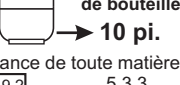
GRILLE DE VÉRIFICATION	
Armoire de rangement - Bouteille de propane	
29- Armoire de rangement	
Permis d'exploitation	
 Date d'émission C. S. 74	1
Bouteilles	
Nombre de bouteilles entreposées _____	2
 A tous les 10 ans Réinspection et remarque des bouteilles B-149.2 6.5.1.9	3
 Bouteille interdite à l'intérieur B-149.2 Entreposage 6.5.1.2	4
 Dispositif d'étanchéité B-149.2 6.5.1.6, 6.1.8	5
 Phase gazeuse Soupape de décharge B-149.2 6.1.7	6
 Peinture (corrosion) Bouteille B-149.2 6.1.5	7
Armoire	
 Protection contre les véhicules B-149.2 Bouteille 5.3.2, 6.7.6	8
 À l'abri de toute manipulation B-149.2 6.5.1.3, 6.5.1.5	9
 Pas de couvercle Minimum 6' (2 m). Sans couvercle B-149.2 6.5.2.4 a	10
 Maximum 2'' x 2'' (50mm x 50mm) B-149.2 6.5.2.4 b	11
 Ouvertures Ouvertures de ventilation B-149.2 6.5.2.4 c	12
 Ancrage Ancrer solidement B-149.2 6.5.2.4 d	13
 Affiche ou pictogramme B-149.2 6.5.2.6	14
 Mur de bâtiment incombustible 4 armoires max. 500 lbs chaque -3 pieds d'une ouverture -10 pieds d'une entrée d'air mécanique -25 pieds de la ligne de propriété (école, église, hôpital, terrain de jeux et lieux de réunion publique) B-149.2 Tableau 6.3 †(note)	15
Dégagements	
 3 pi. Dégagement B-149.2 Tableau 6.3	16
 10 pi. Dégagement B-149.2 Tableau 6.3	17
 Entreposage de bouteilles 500 lbs max. → 0 pi. (Mur combustible) Distance d'un bâtiment B-149.2 6.5.1.9 a	18a
 Entreposage de bouteilles 500 lbs max. → 0 pi. (Mur combustible) Distance d'une ligne de propriété B-149.2 6.5.1.9 b	18b
 Entreposage de bouteilles 500 lbs max. → 10 pi. (Mur combustible) Distance d'une rue, d'un trottoir B-149.2 6.5.1.9 c	18c
 Entreposage de bouteilles 500 lbs max. → 10 pi. (Mur combustible) Distance d'un lieu de réunion publique B-149.2 6.5.1.9 d	18d
 Entreposage de bouteilles → 20 pi. Point éclair < à 100°F (37.8°C) Distance d'un liquide inflammable B-149.2 6.5.1.11	19
 Entreposage de bouteilles 420 lbs max. → 5 pi. Distance d'un appareillage électrique B-149.2 6.5.1.13	20
 Entreposage de bouteilles → 10 pi. Distance de toute matière inflammable B-149.2 5.3.3	21

Commentaires:

Défectuosités (notes explicatives)
