

FOREST PRACTICES

CODE

of

BRITISH COLUMBIA

Fish-stream Crossing Guidebook

March 2002



BRITISH
COLUMBIA

Ministry of Forests

Ministry of Water, Land
and Air Protection

Ministry of Energy and Mines



Fisheries and Oceans
Canada

Pêches et Océans
Canada



OIL AND GAS COMMISSION



of
BRITISH COLUMBIA

Fish-stream Crossing Guidebook

March 2002

Authority

Forest Practices Code of British Columbia Act

National Library of Canada Cataloguing in Publication Data

Main entry under title:

Fish-stream crossing guidebook

(Forest practices code of British Columbia)

Includes bibliographical references: p.

ISBN 0-7726-4754-2

1. Bridges - British Columbia - Design and construction. 2. Forest roads - British Columbia - Design and construction. 3. Stream conservation - British Columbia. 4. Fish habitat improvement - British Columbia. 5. Forest roads - Environmental aspects - British Columbia. I. British Columbia. Ministry of Forests. II. Series.

TE229.F57 2002

634.9'3

C2002-960078-2

© Province of British Columbia

Citation:

B.C. Ministry of Forests. 2002. Fish-stream crossing guidebook. For. Prac. Br., Min. For., Victoria, B.C. Forest Practices Code of British Columbia guidebook.

For copies of this or any guidebook, contact:

Government Publications

PO Box 9452 Stn. Prov. Govt.

Victoria BC V8W 9V7

Telephone: 1-800-663-6105 (outside Victoria)

(250) 387-6409 (within Victoria)

Fax: (250) 387-1120

Internet: <http://www.publications.gov.bc.ca/>

Guidebooks are also available on the

British Columbia Ministry of Forests website at:

<http://www.for.gov.bc.ca/tasb/legsregs/fpc/FPCGUIDE/Guidetoc.htm>

Contents

1 Introduction	1
1.1 Guidebook Objectives	2
1.2 Legislative Authorities and Approvals	2
1.3 Provincial Legislation	2
1.3.1 <i>Forest Practices Code of British Columbia Act</i>	2
1.3.2 <i>Petroleum and Natural Gas Act</i>	3
1.3.3 <i>Mines Act, Mineral Tenure Act, and Mining Right of Way Act</i>	3
1.3.4 <i>Water Act</i>	3
1.4 Federal Legislation	4
1.4.1 <i>Fisheries Act</i>	4
1.4.2 <i>Navigable Waters Protection Act</i>	5
2 Review Processes	6
2.1 New Installations	6
2.2 Replacement Installations	10
2.3 Provincial Review	11
2.3.1 Timing windows	11
2.4 Federal Review	12
2.5 Proponent Application Plan for Stream Crossing Projects	14
3 Design and Installation of Fish-stream Crossings	16
3.1 Open Bottom Structures	16
3.1.1 Design of open bottom structures	16
3.1.2 Installation of open bottom structures	21
3.2 Closed Bottom Structures	22
3.2.1 Design of closed bottom structures	22
3.2.2 Installation of closed bottom structures	26
3.3 Snowfills	31
3.3.1 Design of snowfills	31
3.3.2 Installation of snowfills	31
3.4 Ice Bridges	32
3.4.1 Design of ice bridges	32
3.4.2 Installation of ice bridges	32
3.5 Fords	33
4 Fish-stream Protection Measures	34
4.1 Vegetation Retention at Stream Crossings	34
4.2 Falling and Yarding	35
4.3 Grubbing and Stripping	35
4.4 Slash and Debris	35
4.5 Fording	35
4.6 Erosion and Sediment Control Measures	36
4.6.1 Work site isolation	36
4.6.2 Fish salvage	37
4.6.3 Vegetation soil stabilization	38
4.6.4 Erosion control matting and netting	39

4.6.5 Bioengineering solutions to erosion control	39
4.6.6 Rip rap	39
4.6.7 Drainage control	39
4.6.8 Sediment traps and barriers	41
4.7 Handling Hazardous Substances	42
5 Maintenance Practices	43
5.1 Bridges	43
5.2 Open and Closed Bottom Culverts	44
5.3 Sediment Control	45
6 Deactivation Practices	47
Glossary	64
References and Recommended Additional Reading	66
Appendices	
1. Methodology for determining stream channel width	48
2. Instream work window for provincial fisheries zones	49
2a. Map of provincial fisheries zones	50
3. Example of a proponent application plan for a stream crossing project	51
4. Example construction drawings for an embedded round culvert	54

Figures

1. Definition and indicators of fish habitat types	7
2. Decision-making matrix for selecting type of new installation acceptable for fish-stream crossings	9
3. Review process for new installations	10
4. The federal review process for new and replacement fish-stream crossings	13
5. Common types of bridges	17
6. Types of open bottom culverts	20
7. Typical closed bottom structures	23
8. Stream elevation profile example for use in determining culvert slope and minimum invert level for an embedded culvert	24
9. Determining stream channel width	27
10. Typical downstream weir	29
11. Culvert backfill compaction	30
12. Temporary winter stream crossings using compacted snowfills	31
13. Drainage control at a stream crossing	40

1 Introduction

This guidebook is designed to help forest and other resource managers and practitioners plan, prescribe, and implement sound forest practices for fish-stream crossings that comply with both the Forest Practices Code and the federal *Fisheries Act*.

It was prepared under the direction of a multi-agency steering committee, with technical input from provincial and federal government agency staff, resource industry personnel, and individuals in private practice. Represented on the steering committee were:

- the Province of British Columbia: Ministry of Forests; Ministry of Water, Land and Air Protection; Ministry of Energy and Mines; and Oil and Gas Commission
- the Government of Canada: Department of Fisheries and Oceans (DFO)
- the Council of Forest Industries (COFI)

The guidelines contained here are the product of considerable communication and consensus-building effort among the committee members and their technical reviewers. With the support of management and the executive of each organization, the steering committee was able to achieve the desired policy objectives. The result is that the processes and practices are considered to be reasonable, practical, and acceptable to both practitioners and review agencies alike.

By following the procedures detailed in this guidebook, users can work to achieve a balance among the needs of the forest, mining, and oil and gas industries, as well as of the needs of those who are empowered to protect the fishery resource. The information provided here should help users exercise their professional and technical judgement in developing site-specific management strategies and prescriptions to meet resource management objectives. The recommendations set out a range of options or outcomes considered to be acceptable under varying circumstances.

Specifically, the guidebook provides users with technical, statutory reference, and process guidance for selecting and designing fish-stream¹ crossings on forest roads (as well as mineral and petroleum access roads) that should (1) avoid harming fish and fish habitat, and (2) provide fish passage at stream crossing sites. Examples are given to illustrate the methods and recommended procedures for road crossings of streams in an effective and efficient manner. The *Forest Practices Code of British Columbia Act* and the federal *Fisheries Act* provide for safe fish passage and the protection of fish and fish habitat. (See the Glossary for the federal definition of fish and fish habitat.)

¹ The Forest Practices Code definition of a fish stream is included in the Glossary. See also the *Forest Practices Code Fish Stream Identification Guidebook*.

Not provided here is guidance for engineering practices related to the design and stability of drainage structures. Rather, the emphasis is on fish habitat and fish passage. For further discussion on structural or hydrological requirements, refer to the Forest Practices Code *Forest Road Engineering Guidebook* and the Ministry of Forests *Bridge Design and Construction Manual*.

These guidelines do not preclude the use of other processes and structures, provided they meet the requirements of provincial and federal legislation. See “References and Recommended Additional Reading” at the end of the guidebook.

1.1 Guidebook Objectives

This guidebook aims to provide forest and other resource management practitioners with guidance in:

- protecting fish and fish habitat and accommodating the safe passage of fish during the location, design, installation, maintenance, and deactivation of stream crossings;
- administering an efficient proponent submission and review process that addresses all federal and provincial legal requirements involved in the construction, maintenance, and deactivation of stream crossing structures; and
- pursuing options that recognize the value and sensitivity of fish and fish habitat in balance with other environmental, social, resource, and economic values.

1.2 Legislative Authorities and Approvals

The Forest Practices Code regulates the construction, maintenance, and deactivation of stream crossings on Crown land in a provincial forest. However, other federal and provincial authorities also have jurisdiction in some cases to regulate works in and about streams. For example, Habitat staff in the Department of Fisheries and Oceans operate under the Federal *Fisheries Act*, which has prohibitions related to fish passage and fish habitat. The staff are further guided by their department’s “Policy for the Management of Fish Habitat,” which contains a long-term objective of net gain of the productive capacity of fish habitats.

1.3 Provincial Legislation

1.3.1 Forest Practices Code of British Columbia Act

The *Forest Practices Code of British Columbia Act* has a legal framework that consists of an Act and planning and practices regulations. The Code provides the umbrella legislation for forest practices in British Columbia, including the design, construction, maintenance, and deactivation of stream crossings on forest roads. Those proponents who receive authorization to carry out instream works must do so in accordance with the Act and the regulations.

The regulations define fish streams and provide detailed requirements directing the administration, planning, design, and field practices associated with fish-stream crossings.

1.3.2 Petroleum and Natural Gas Act

The Oil and Gas Commission is the regulatory body that provides the approvals for petroleum roads. The layout and design of petroleum roads, including stream crossings, are considered and approved under the *Petroleum and Natural Gas Act*, and are not subject to the Forest Practices Code. However, the construction, maintenance, and deactivation of petroleum roads are covered under the Code and the provisions of the Forest Road Regulations. (Readers requiring more information should contact the Oil and Gas Commission for more information on the petroleum road application and review process.)

1.3.3 Mines Act, Mineral Tenure Act, and Mining Right of Way Act

The Ministry of Energy and Mines regulates exploration activities on mineral tenures, under the Mineral Exploration Code. The Mineral Exploration Code is a regulation of the *Mines Act* and its standards are similar to, and supersede, the *Water Act* and the Forest Practices Code. Off-tenure roads must meet the requirements of the Forest Practices Code for construction, maintenance, and deactivation.

Under the *Mineral Tenure Act*, a free miner has the right to enter all mineral lands in order to locate a claim or explore for, develop, and produce minerals. Additionally, the *Mining Right of Way Act* gives a mineral claim holder or free miner the right-of-way to construct or maintain mining facilities and to transport mineral or equipment and supplies into and from the mining property.

1.3.4 Water Act

Water Management Branch of the Ministry of Water, Land and Air Protection licenses and regulates water under the *Water Act*. The Oil and Gas Commission also has authority for certain sections of the *Water Act* that pertain to any alterations to, and work in and about, a stream for a petroleum road or other petroleum- or pipeline-related operation. (For more information, readers should contact the Oil and Gas Commission.)

The *Water Act* permits forest activities under the *Forest Practices Code of British Columbia Act* to be conducted without the requirement to notify the Water Management Branch.

Section 44(3) of the *Water Act* Regulation also exempts a person who holds a permit under Section 10 of the *Mines Act* from having to comply with the regulation, as long as that person complies with Part 11 of the Health, Safety

and Reclamation Code for Mines in B.C., and with all conditions of the permit respecting changes in and about the stream.

1.4 Federal Legislation

1.4.1 Fisheries Act

Responsibility for the administration of the *Fisheries Act* rests with the federal Minister of Fisheries and Oceans Canada (DFO). Habitat management staff in the department (DFO-Habitat) have responsibility for protecting fish and fish habitat under the habitat provisions of the *Fisheries Act*.

The following prohibitions in the *Fisheries Act* are relevant to stream crossings:

- obstructions of fish migration (section 22 and 26);
- destruction of fish (section 32);
- harmful alteration, disruption, or destruction (HADD) to fish habitat (section 35) unless authorized; and
- depositing of substances deleterious to fish in waters frequented by fish (section 36).

The Minister of Fisheries and Oceans Canada may require a proponent to submit plans or specifications for works or undertakings that result, or may likely result, in the harmful alteration, disruption, or destruction of fish habitat (section 37).

If a particular stream crossing is deemed an obstruction to fish passage, the Minister may also require a proponent to ensure the free passage of fish (Section 20).

Where a stream crossing may result in the harmful alteration, disruption, or destruction of fish habitat, DFO-Habitat staff can authorize the activity to go ahead only under Section 35(2) of the *Fisheries Act*. To do that, DFO-Habitat first conducts a screening-level assessment of the stream crossing project under the *Canadian Environmental Assessment Act* (CEAA) and refer the project plans and specifications to other federal agencies, such as the Canadian Wildlife Service and the Canadian Coast Guard Navigable Waters Protection Division. Any residual impacts (piers, etc.) to fish habitat from authorized stream crossings are also subject to compensation under the *Fisheries Act*.

1.4.2 Navigable Waters Protection Act

The *Navigable Waters Protection Act* of Canada regulates any activity in, around, under, and over navigable waters,² and is administered by the Canadian Coast Guard of the DFO. Authorization under this Act is required for all stream crossings on navigable waters. Approval for works on navigable waters requires consultation with the Canadian Coast Guard, as does approval for work occurring on navigable waters below the high water mark, such as dredging, placement of rip rap, or bridge or major culvert replacement.

² Navigable waters are defined as any waters capable of being used for commerce, transportation, or recreation.

2 Review Processes

This section provides guidance on the agency review requirements and for selecting the appropriate type of structure for any given site, based on stream gradient and fish habitat present. The approval of forest road layout and design falls under the Forest Practices Code.

The approval of petroleum road layout and design falls under the jurisdiction of the Oil and Gas Commission. Exploration activities on mineral tenures are regulated by the Mineral Exploration Code (discussed in Section 1.3.3).

2.1 New Installations

Note: **Stream channel width** is an important concept used throughout this guidebook. It is defined as the horizontal distance between the stream-banks on opposite sides of the stream, measured at right angles to the general orientation of the banks. The point on each bank from which width is measured is usually indicated by a clearly visible change in vegetation and sediment texture. This border is sometimes shown by the edges of rooted terrestrial vegetation. Above this border, the soils and terrestrial plants appear undisturbed by recent stream erosion. Below this border, the banks typically show signs of both scouring and sediment deposition. Figure 9 provides two illustrations of stream channel width. In addition, a methodology for determining stream channel width is described in Appendix 1.

- The proponent should conduct an evaluation of the fish habitat at the crossing site to determine whether the habitat is critical, important, or marginal. These terms are defined in Figure 1. This habitat evaluation should be conducted by a qualified professional or technologist with adequate training and knowledge of fish habitat. Consideration should be given to flow, current, cover, depth, substrate, and general habitat type (pool, riffle, glide) to justify classification of marginal habitat. Where economics or other issues warrant, the proponent may default to a clear span structure.

Figure 2 provides a matrix to assist the proponent in selecting the most appropriate crossing structure type, selected from:

- open bottom structures (e.g., bridges, open bottom culverts [log culverts, arch culverts])
- closed bottom structures (e.g., corrugated metal pipes)
- other structures (e.g., ice bridges and snowfill)

These structures are discussed in detail in Section 3.

	Habitat at Crossing Site		
	Critical	Important	Marginal
Definition	Habitat that is critical in sustaining a subsistence, commercial, or recreational fishery, or species at risk (red- and blue-listed and COSEWIC list) because of its relative rareness, productivity, and sensitivity. ^a	Habitat that is used by fish for feeding, growth, and migration, but is not deemed to be critical. This category of habitat usually contains a large amount of similar habitat that is readily available to the stock.	Habitat that has low productive capacity and contributes marginally to fish production.
Indicators ^b	<ul style="list-style-type: none"> The presence of high-value spawning or rearing habitat (e.g., locations with an abundance of suitably sized spawning gravels, deep pools, undercut banks, or stable debris, which are critical to the fish population present) 	<ul style="list-style-type: none"> Important migration corridors The presence of suitable spawning habitat Habitat with moderate rearing potential for the fish species present 	<ul style="list-style-type: none"> The absence of suitable spawning habitat, and habitat with low rearing potential (e.g., locations with a distinct absence of deep pools, undercut banks, or stable debris, and with little or no suitably sized spawning gravels for the fish species present)

a See www.gov.bc.ca/wlap/ or <http://www.cosewicgc.ca/cosewic>.

b The indicators provided here are highly generalized and require regional interpretation. Those involved in conducting habitat assessments should contact the regional office of DFO-Habitat and the Ministry of Water, Land and Air Protection.

Figure 1. Definition and indicators of fish habitat types.

Once the most appropriate type of crossing structure has been determined (using Figures 1 and 2), Figure 3 can further assist the proponent in determining whether or not an authorization is required from DFO-Habitat.

- The review process for forest roads crossing fish streams potentially involves two levels of government — provincial and federal. The provincial review process is outlined below in Section 2.3; the federal review process is outlined in Section 2.4. To expedite the review, fisheries agency referrals should be accompanied by a proponent application plan (see Section 2.5) that contains all necessary information.

- In general, an open bottom structure (OBS) does not require site-specific fisheries agency approval if the crossing is constructed within the timing window (see Appendix 2), and if it spans the stream without:
 - disturbing instream fish habitat,
 - encroaching on the stream channel width, and
 - causing excessive³ loss of riparian vegetation.

Note:

*Some small, arch-type structures installed on fish streams require excavation and reconstruction of the streambed and streambanks. **These should be treated as closed bottom structures for review process purposes.***

- In marginal fish habitat, where the stream gradient is 6% or less and where the streambed is wide and deep enough to be excavated and the closed bottom structure (CBS) properly embedded, the proponent can proceed without site-specific fisheries agency approval, provided that (1) the installation is carried out within the timing window and (2) design and installation are carried out according to Section 3.2 of this guidebook.
- In important and critical fish habitats, and in marginal fish habitat where stream gradient exceeds 6% (boxes A to E and G to H, Figure 2), the installation may likely require a Section 35(2) authorization (*Fisheries Act*), so a referral to DFO-Habitat is highly recommended.

Fisheries agency approval for a closed bottom structure in the black portion of the habitat/gradient matrix (Figure 2) is unlikely because of the difficulty in providing and maintaining fish passage in such conditions and in protecting the existing critical habitat. Approval would be considered only where no other practicable alternative exists.

- Plans and specifications for crossings constructed without fisheries agency referral should be retained by the proponent and made available to the agency upon request.

3 Only the vegetation required to meet operational and safety concerns for the crossing structure and the approaches is to be removed. All efforts should be made to minimize impacts on the riparian fish habitat beyond the toe of the fill at the crossing site.

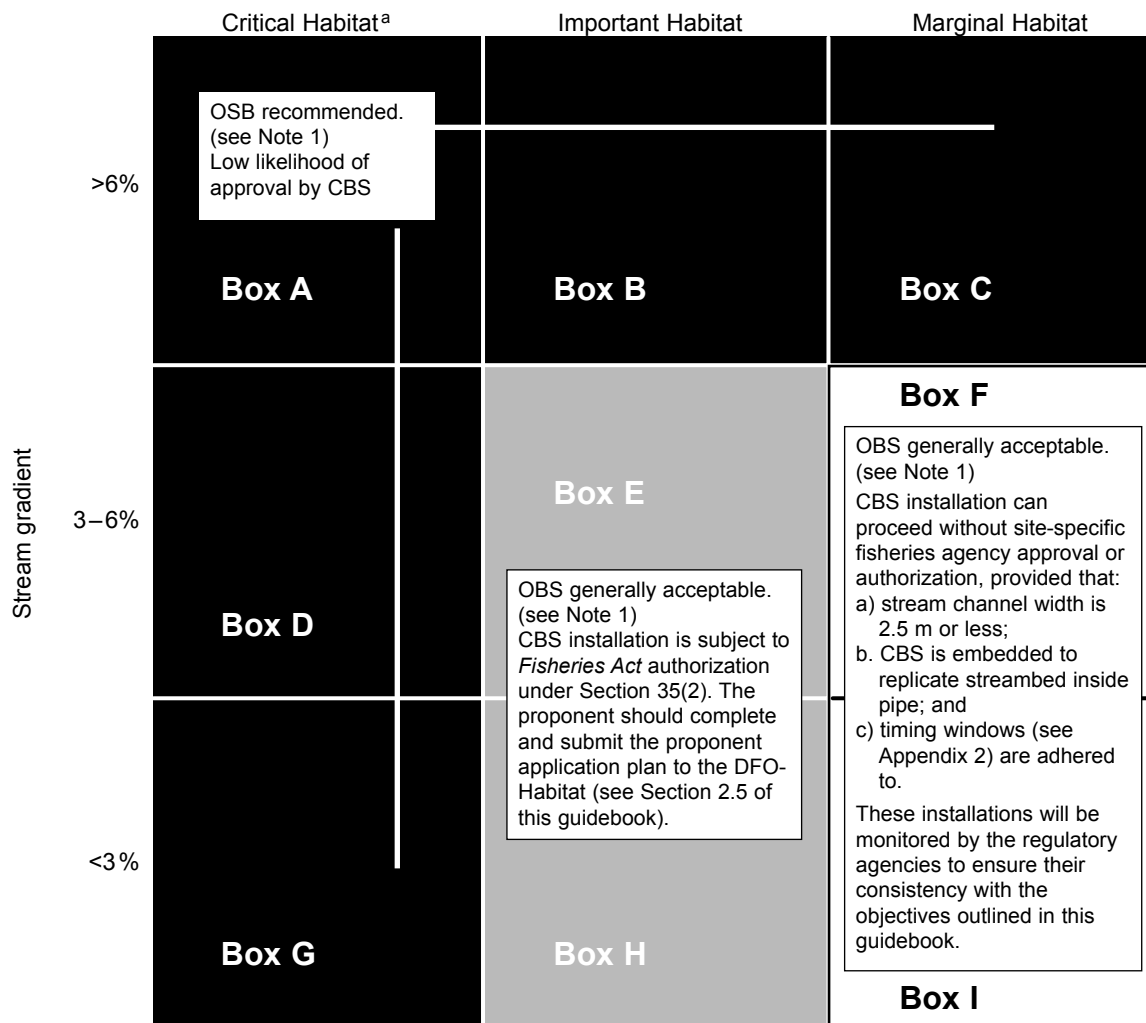

^a See Figure 1 for habitat definitions and examples. OBS — open bottom structure, CBS — closed bottom structure.

Figure 2. Decision-making matrix for selecting type of new installation acceptable for fish-stream crossings.

Notes:

1. No agency approval or authorization is necessary for any OBS, if the crossing spans the stream without (a) disturbing instream habitat, (b) encroaching on stream channel, or (c) causing excessive loss of riparian habitat. If (a), (b), or (c) is anticipated, a *Fisheries Act* authorization is required regardless of habitat value or stream gradient. The proponent should complete and submit the proponent application plan for a Section 35(2) authorization to the DFO-Habitat (see Section 2.5 of this guidebook). Figure 4 outlines the review process.
2. The figure includes a gradient breakdown at 3% that has no influence on the outcome of the matrix. It is shown here to emphasize the increased risk associated with the maintenance of substrate in embedded culverts as slope increases. Requirements for substrate size and placement also differ for culverts installed at gradients greater than 3% (see Section 3.2).
3. Other factors (such as fans and debris potential) may also need to be considered for the selection of a structure and assessment of its structural integrity.

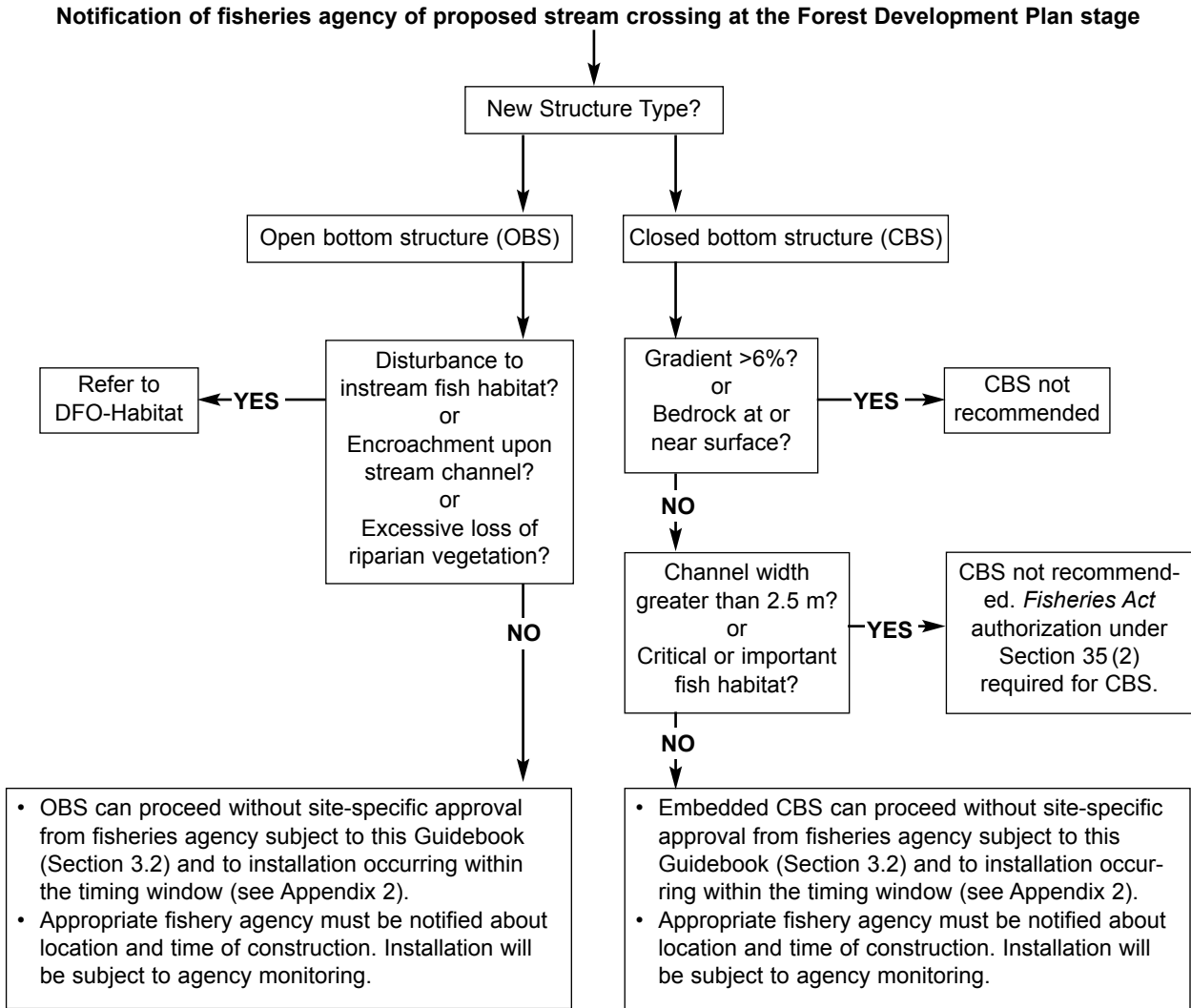

Figure 3. Review process for new installations.

2.2 Replacement Installations

Replacement structures are defined as those that occupy the same riparian management area and crossing location in plan view as the original structure.

- All replacement structures should be treated as new installations (see Section 2.1), except where a closed bottom structure is being replaced with an open bottom structure.
- Replacement structures can proceed without site-specific approval. The appropriate fisheries agency should be notified of the location and timing of the construction.

2.3 Provincial Review

The provincial review is focused on achieving the following objectives at the crossing site:

- protecting of fish and fish habitat by:
 - preventing impacts on fish eggs and alevin that are present in the gravel, or on adult and juvenile fish that are migrating or rearing, and
 - reducing the risk of releasing sediment or other deleterious substances during work at stream crossings; and
- providing for fish passage.

2.3.1 *Timing windows*

Timing windows (see Appendix 2) are periods of time when work in and about a stream can be conducted with reduced risk to fish and fish habitat. They are also referred to as “windows of least risk” and define the period of time when equipment may be permitted to work in a stream.

Timing windows are specific to fish species and the geographic area within which the work is conducted. This period of least risk is determined by such factors as the time when there are no known fish eggs or alevin (pre-emergent fry) present in the stream substrate, and when streamflow is low and soil conditions are dry.

- During the planning of instream work, consideration should be given to all of the fish species present in a stream. Depending on the mix of species present, there can be overlapping constraints on the timing of operations. The following conditions, if met, result in a year-long timing window (i.e., January 1–December 31):
 - The structure does not encroach into the stream channel width, no work is proposed within the stream channel of a fish stream or fisheries-sensitive zone, and the risk of sediment delivery is low.
 - The work is on a non-fish stream and the appropriate measures should be taken to prevent the delivery of sediments into fish habitat.
 - During construction, modification, or deactivation activities, the stream channel at the crossing is completely dry.
 - Construction, modification, or deactivation activities on a non-fish stream that is a direct tributary to a fish stream are carried out by isolating the work area and keeping dry conditions by temporarily pumping, or otherwise diverting, the flow around the work site while instream activities occur.
- During a timing window, juvenile or adult fish may still be present on site. This is generally the case for resident fish species and for those fish that reside in streams for a period of time before migrating to other areas. For this reason, construction should stop any time it is anticipated that unfavourable soil moisture or rainfall conditions exceed an operation capability for sediment control. Work should not resume until conditions

permit. Indicators that sediment control capacity has been exceeded include dirty ditch water, mud holes, and unstable road cuts near the stream.

- If a timing extension is required, the appropriate fisheries agency should be notified and approval obtained if required.

2.4 Federal Review

The *Decision Framework for the Determination and Authorization of HADD of Fish Habitat* (1998) describes DFO-Habitat's approach to reviewing requests for subsection 35(2) *Fisheries Act* authorizations. Such authorizations are not required where there is no harm to habitat. A stream crossing avoids damage to fish habitat if it spans the stream without:

- disturbing the instream fish habitat,
 - encroaching on the stream channel width, or
 - causing excessive loss of riparian vegetation
-
- Figure 2 provides an initial screening step in determining the need for project referral to DFO-Habitat. In general, a DFO-Habitat review centres on the value and sensitivity of the fish habitat. All fish habitats contribute to the success and productivity of fish generally, albeit often indirectly through food production and other factors. Therefore, any reduction in the quantity and quality of fish habitat may reduce fish productivity to some degree. Some habitat types make a greater contribution to fish productivity than others. Critical habitats are those where incremental reductions in their supply may result in the largest incremental reductions in fish productivity. Cumulative changes in ecosystems may result in a non-critical habitat becoming critical, and in this way shifts the focus in the selective protection of critical habitats.
-
- As illustrated in Figure 4, when a referral to DFO-Habitat is required (boxes A to E and G to H, Figure 2), a qualified professional or technologist with adequate training or knowledge of fish habitat should prepare a proponent application plan. Then, DFO-Habitat should review the value and sensitivity of the habitat involved and the mitigation or compensation proposed to determine whether an authorization under Section 35(2) of the *Fisheries Act* may be issued. A decision by DFO-Habitat to authorize the harmful alteration, disruption, or destruction (HADD) of fish habitat triggers an environmental review under the *Canadian Environmental Assessment Act* (CEAA). In critical habitat (see Figure 2, boxes A to D and G), the HADD of fish habitat is generally unacceptable and it is unlikely that approval from DFO-Habitat will be given in these situations. Therefore, an open bottom structure that does not affect fish habitat is strongly recommended. However, should a proponent wish to proceed with the installation of a closed bottom structure in critical habitat, the application should be accompanied by a proponent application plan for stream crossings, for review by DFO-Habitat (see Section 2.5 below).

- Installation of stream crossings that result in a HADD can proceed only under a Section 35(2) authorization. Proceeding to a Section 35(2) authorization should be considered only after all relocation and redesign options have been investigated and rejected with appropriate justification. If relocation or redesign is not practical, the complete project should be assessed, including proposed compensation measures, to ensure all concerns relating to HADD of fish habitat have been addressed prior to authorization. Conditions regarding habitat compensation measures should be formalized in the terms and conditions of the authorization.
- Installation of an embedded closed bottom structure is normally acceptable where stream gradients are 6% or less, stream channel width is 2.5 m or less, and there is adequate streambed depth to permit excavation. Such installations may proceed with no site-specific approval or authorization in marginal habitat (see Figure 2, boxes F and I), provided requirements to mitigate any damage to fish habitat are met (as outlined in Section 4 of this guidebook). In important habitat, these installations will require a *Fisheries Act* authorization under Section 35(2). However, expedited reviews are anticipated for those closed bottom structures that meet the criteria above and are not excessively long.

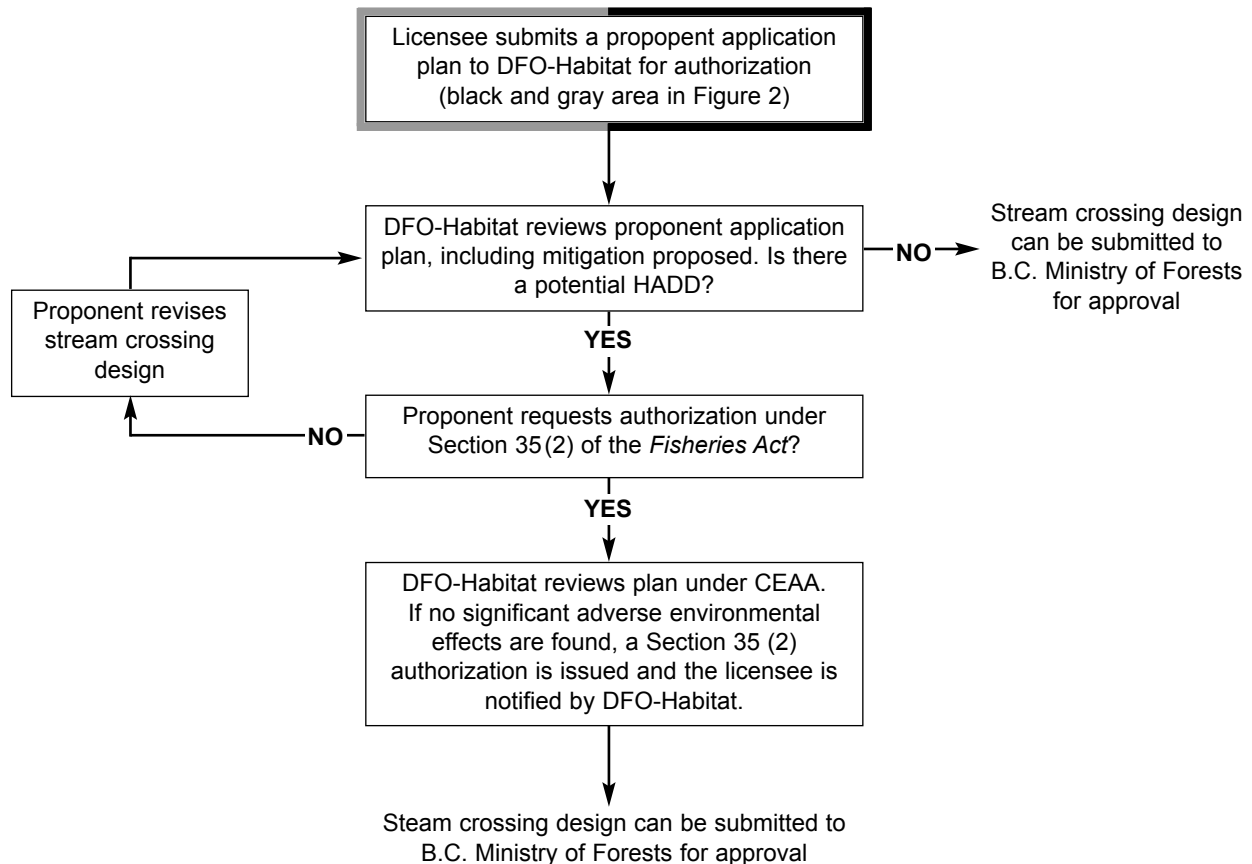

Figure 4. The federal review process for new and replacement fish-stream crossings.

- The proponent should conduct an evaluation of the fish habitat at the crossing site to determine whether the habitat is critical, important, or marginal (see Figure 1). This habitat evaluation should be conducted by a qualified professional or technologist with adequate training and knowledge of fish habitat. Consideration should be given to flow, current, cover, depth, substrate, and general habitat type (pool, riffle, and glide) to justify classification of marginal habitat. It is important to keep in mind that the indicators that differentiate the three habitat types provided in Figure 1 are generalized. Fisheries agency consultation is required where regionally specific guidance is needed for habitat evaluation and classification at the crossing site.

Before the installation of any fish-stream crossing structure goes ahead, DFO-Habitat should be notified. The installations should be identified on a map of an appropriate scale so that they can be monitored to ensure that the habitat at the site has been properly classified, and to ensure that they are consistent with the objectives outlined in this guidebook.

- Practitioners should be adequately trained in the design and installation of an embedded closed bottom structure (as outlined in Section 3.2) and in the recommended techniques for mitigating impacts to fish habitat during construction of an embedded culvert. The goal is to retain the natural stream substrate characteristics within the culvert. Migrating fish should suffer no changes or stress and no delay in upstream migration. Substrate should also move through the culvert naturally.

2.5 Proponent Application Plan for Stream Crossing Projects

- For proposals that require review by DFO-Habitat, a proponent application plan should be completed and submitted along with the stream crossing plan.
- This plan encompasses five major components that outline the proposed works, describe possible impacts on fisheries resources or water quality, and set out steps that should be undertaken to minimize or avoid any possible impacts. The plan should detail:

1. Fisheries Resource Values

Provide a detailed description of the existing fisheries resource values of the area that could be affected by the proposed works, including hydrologic features, water quality, species of fish that frequent the waterbody, fish habitat present (e.g., spawning, rearing, over-wintering, or migration), and riparian vegetation. The sensitivity of the habitat to disturbance should also be described (e.g., soil type, bank stability, substrate type, and gradient).

2. Description of Proposed Activities

Provide a detailed description of the proposed works, along with general arrangement drawings that indicate how the works are to be carried out, including all machinery and materials to be used, road maintenance requirements, and deactivation plans. A project time schedule is also required, which should include activities and applicable timing windows that may apply. In addition, methods to maintain fish passage for the lifespan of the structure should be clearly stated.

3. Impacts to the Fisheries Resources

Discuss anticipated impacts to fisheries and habitat values, including the identification of the nature, duration, magnitude, and location of potential impacts, and the effects on fish and fish habitat in downstream areas. All anticipated changes to fish habitat as a result of construction, maintenance, and deactivation should be stated. Justification for any changes in the natural stream boundary, such as relocation of the channel or constriction of the stream channel width due to fill or rip rap, should be provided, as well as for any predicted changes to downstream flows, bars, and streambanks.

4. Mitigation Proposed

Provide a description of all measures (actions and contingencies) that should be taken to avoid, reduce, or eliminate any impacts outlined in point 3 above. It should include a discussion of any proposed habitat compensation works undertaken to achieve “no net loss” of fish habitat as required. A subsequent *Fisheries Act* authorization may require approved habitat compensation works to be carried out.

5. Environmental Monitoring

Environmental monitoring may be required where construction occurs in critical or important habitats or where construction is authorized outside of the timing window. The purpose of this is to identify actions to be taken to ensure that all proposed activities as outlined are completed and meet the requirements of the fisheries agency granting approval for the works.

Environmental monitors may be qualified professionals or technologists who have adequate training or knowledge of fish habitat and a comprehensive working knowledge and understanding of the principles and requirements outlined in this guidebook. The impacts of construction activities can be continually monitored or periodically inspected, depending on the sensitivity of the site to disturbance and the nature of construction. The environmental monitor should be given authority by the proponent to stop operations in the case of non-compliance with approved conditions, or where it is anticipated that unforeseen circumstances are likely to cause environmental problems.

- See Appendix 3 for an example of a proponent application plan.

3 Design and Installation of Fish-stream Crossings

This section discusses the design considerations and installation practices recommended for various types of stream crossing structures. Refer to the Forest Practices Code *Forest Road Engineering Guidebook* and the *Forest Service Bridge Design and Construction Manual* for details on the location and design of forest roads and stream crossings.

- Fish-stream crossing structures should retain the pre-installation stream conditions to the extent possible. The objective is to ensure that the crossing does not restrict the cross-sectional area or change the stream gradient, and that the streambed characteristics are retained or replicated.
- The choice and design of fish-stream crossing structures are determined by a number of factors, including sensitivity of fish habitats, engineering requirements, cost and availability of materials, and cost of inspection, maintenance, and deactivation. Not all options are appropriate on all sites. The types of structures recommended in this guidebook for use on forest roads include:
 - open bottom structures (e.g., bridges, open bottom culverts [log culverts, arch culverts])
 - closed bottom structures (e.g., corrugated metal pipes)
 - other structures (e.g., ice bridges and snowfill)
- This list does not preclude the use of other structures, or a combination of structures, provided they meet the requirements of provincial and federal legislation. However, baffled culverts are not recommended for new installations. The hydraulic design requires specialized hydraulic modeling skills that go beyond the scope of this guidebook. In addition, locating roads and crossing structures in alluvial fans, where streams are in active floodplains, or where streams are meandering or braided may require special design considerations not included in this guidebook. Where such installations are considered, a professional engineer and fisheries biologist should be consulted.

3.1 Open Bottom Structures

3.1.1 Design of open bottom structures

For forest roads in British Columbia, open bottom structures for fish-stream crossings include bridges and culverts.

3.1.1.1 Bridges

When designed and constructed with abutments that do not constrict the stream channel, bridges have the least impact on fish passage and fish habitat.

- Bridges can be designed for permanent, temporary, or seasonal installation. They range from log stringer bridges with gravel or timber decks, to steel girder bridges with timber or pre-cast concrete decks (see Figure 5). Bridges can be supported by various means, including log cribs, steel pipes, steel bin walls, cast-in-place concrete, and pre-cast lock block walls, timber, and piers. Where practicable, instream piers should be avoided. Piers can collect debris during flood events, resulting in scouring of bridge foundations. Instream piers can also result in hydrologic changes such as bedload scour or deposition, which may adversely affect fish habitat.

It can be expected that fisheries agencies may approve only bridges with support piers after all other options (clear span) are considered.

Steel girder bridge

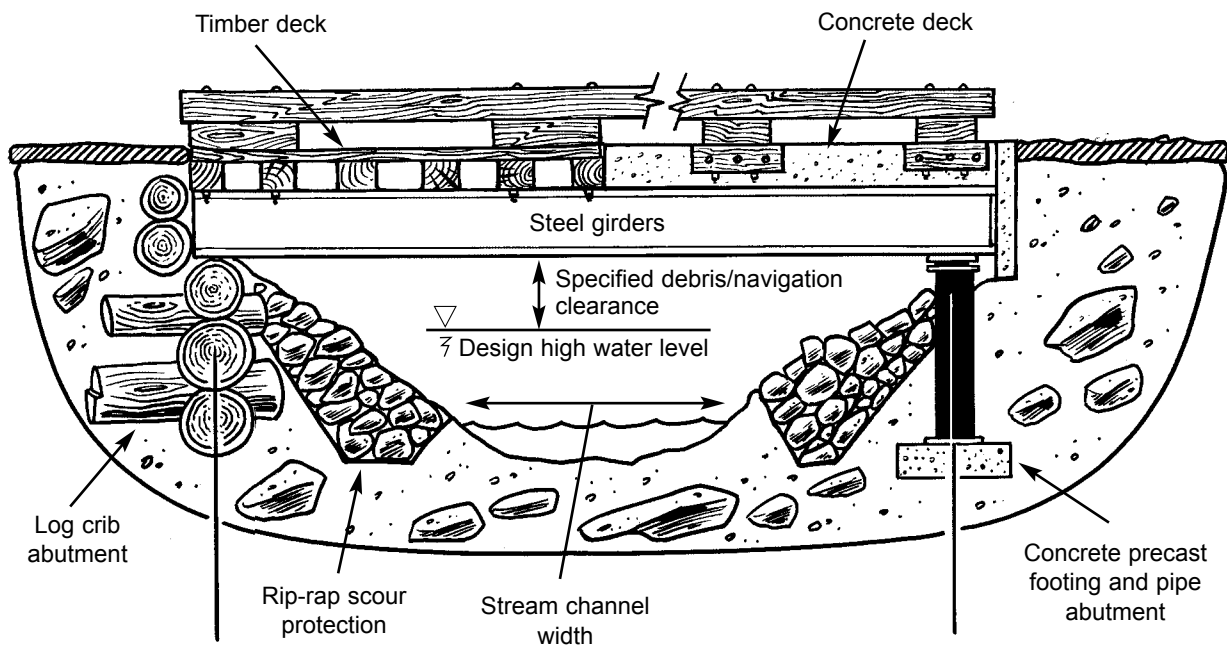
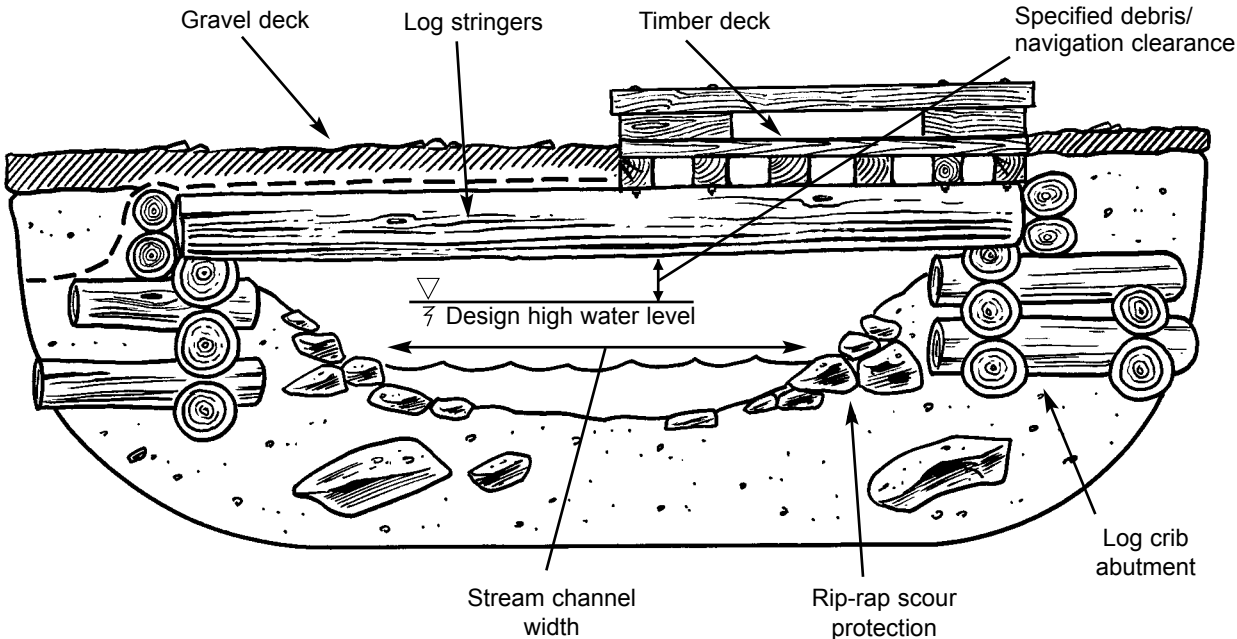

Figure 5. Common types of bridges.

Log stringer bridge



Concrete slab bridge

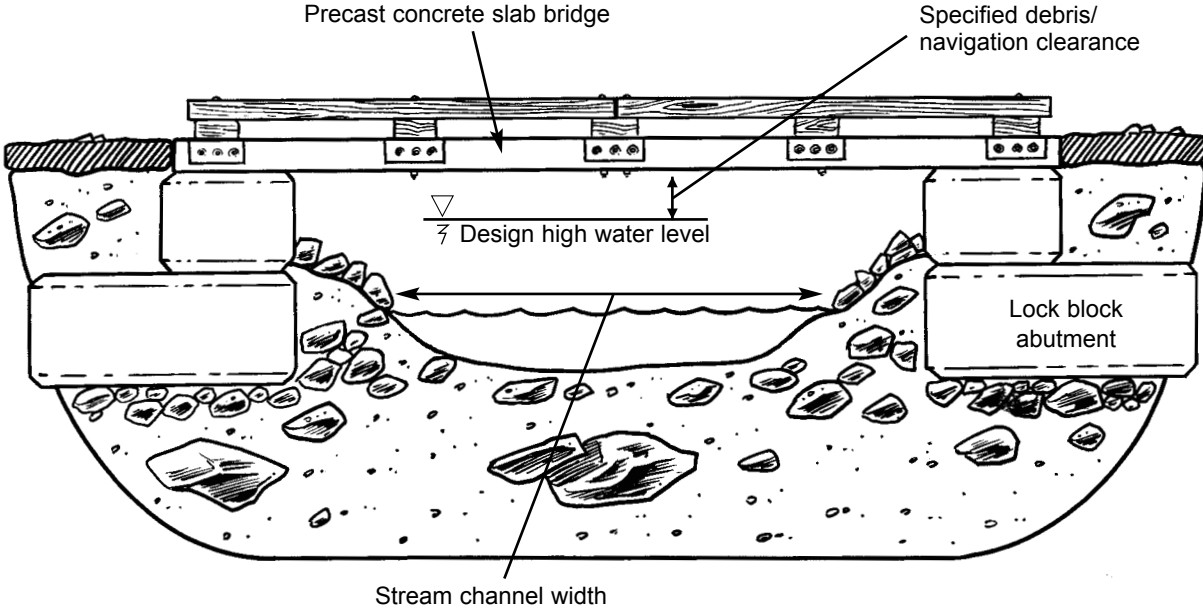

Figure 5. Common types of bridges (continued).

- Decisions to use a bridge rather than a culvert can be driven by economics, engineering requirements, site parameters, environmental or hydraulic concerns, or bedload and debris transport factors. References related to each of these activities are contained in “References and Recommended Additional Reading.”

3.1.1.2 Open bottom culverts

Open bottom culverts are similar to bridge structures, generally spanning the entire streambed and minimizing impacts to the natural stream channel (see Figure 6). They are differentiated from bridges in that the fill placed over these structures is an integral structural element.

- The most common type of open bottom structure is the log culvert. It is widely used in areas where the availability of suitable logs makes it an economical alternative to steel or concrete. Log culverts are readily adapted to meet flood requirements and generally do not pose a risk to fish passage when sill logs are placed to maintain the stream channel width. The bottomless culvert should be designed to span the stream channel width and so avoid impacts on fish habitat and fish passage.

Depending on the stream profile, large sill logs or log cribbing may be required with log culverts to achieve adequate flow capacity. Alternatively, small sill logs can be used, but the span should be increased to get sill logs well above and outside the scour zone of the stream.

- Other types of open bottom culverts include arches constructed of steel, plastic, and other materials. Arches come in various shapes, ranging from low to high profiles and are typically installed on concrete or steel foundations.
- It is important to differentiate small, arch-type open bottom structures requiring excavation and reconstruction of the streambed from larger arches that are constructed without disturbance to the streambed. The small bottomless arches should be installed with the same considerations afforded closed bottom structures (see Section 3.2). Careful engineering is required to ensure that the footings of these small arches are secure and not subject to undercutting.

Log culvert

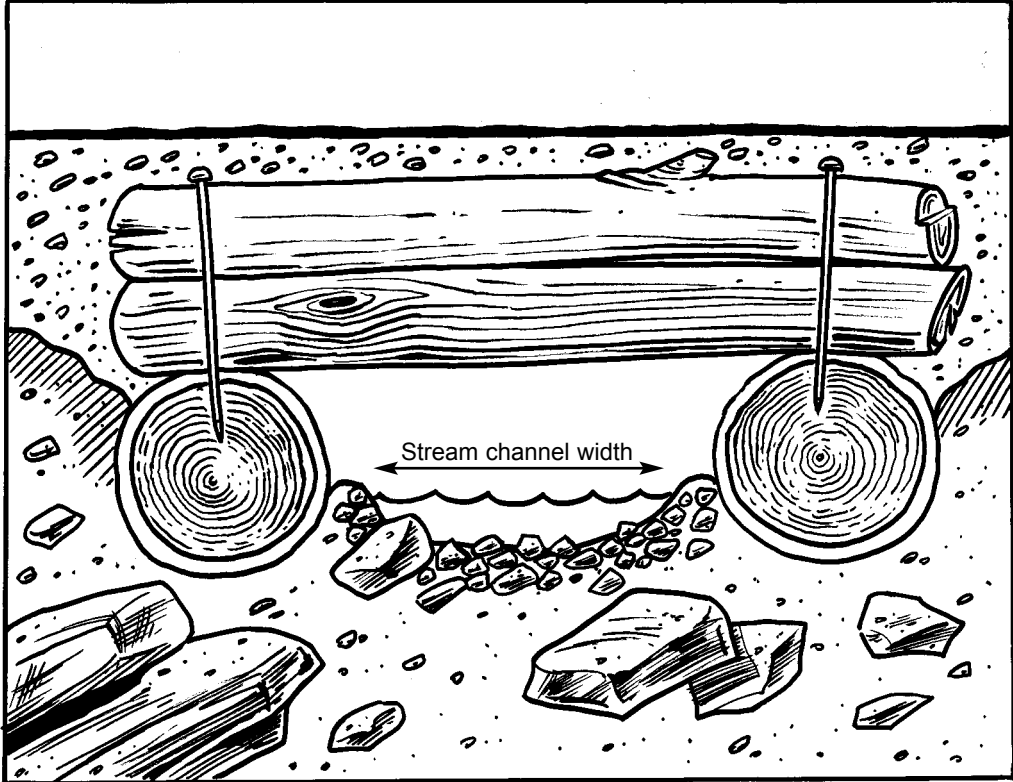

Low-profile arch

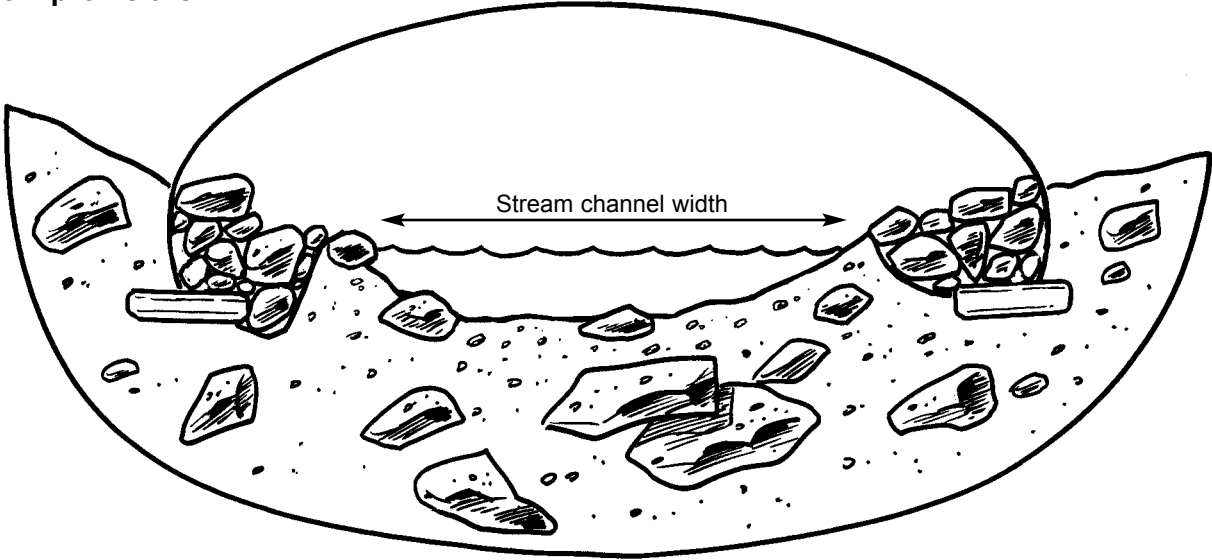

Figure 6. Types of open bottom culverts.

3.1.2 Installation of open bottom structures

- The steps below outline the general installation procedure for open bottom structures as they apply to fish streams. Refer to the *Forest Road Engineering Guidebook* and the *Forest Service Bridge Design and Construction Manual* for more details on construction practices.

Footings:

Ensure that excavation and backfilling for footings does not encroach on the stream channel width.

Vibrations during construction:

Practices such as pile driving and blasting that result in vibrations potentially harmful to fish or fish eggs should be carried out during the instream timing windows. Fish salvage may be required to remove the fish from harm. See Wright and Hopky (1998).

Sediment control at work site:

Where feasible, operate all equipment from above the top of the streambank, isolate the work area from water sources, contain sediments within the work site, and pump out sediment-laden water to a settling site during construction and installation.

Drainage:

Do not allow road ditches to drain directly into the stream (see Figure 13). Divert ditch water into a constructed sump or, where possible, onto stable forested vegetation that can filter sediments before reaching the stream. Ensure that adequate cross drainage is in place before the bridge approach, to minimize water volume directed into approach ditches at bridge sites. Consider crowning the surface, using rolling grades, or employing other practices to divert runoff from the road surface. Where cross-ditches are used, ensure that they are properly armoured at the outlet and along the base.

Constricting the stream:

Do not allow activities, including the placement of rip rap, to cause any constriction of the stream channel width (see Figure 6).

Deleterious materials:

Use precautionary measures to prevent deleterious substances such as new concrete, grout, paint, ditch sediment, fuel, and preservatives from entering streams. If wood preservatives that are toxic to fish are used, they should be used in accordance with the publication entitled *Guidelines to Protect Fish and Fish and Fish Habitat from Treated Wood used in Aquatic Environments in the Pacific Region*.

Seepage barriers:

Consider using geotextiles to prevent loss of fines and gravel through seep-

age along the arch wall. The fabric, or other cut-off measures such as sand-bagging or use of prefabricated seepage barriers along the arch wall near the inlet, is intended to prevent most of the seepage and mitigate potential support fill erosion that can occur along the arch.

Geotextiles:

For gravel-decked bridges or log culverts, use a geotextile filter fabric to fully cover the stringers or some other measure to prevent road material from entering the stream.

Turnouts:

Construct turnouts a sufficient distance from the bridge to prevent road material from entering the stream and to minimize impacts on riparian vegetation.

3.2 Closed Bottom Structures

3.2.1 *Design of closed bottom structures*

For forest roads in British Columbia, closed bottom structures for fish-stream crossings are corrugated pipes (metal or plastic), which, embedded to retain stream substrate, provide fish habitat and fish passage.

- Closed bottom structures are not allowed in critical fish habitat, but are an option in small streams with a stream channel width 2.5 m or less (small S3 and S4 streams) and 6% average stream gradients or less (see Figure 7). Should a proponent wish to proceed on a larger or steeper-gradient stream, an application should be submitted with the proponent application plan for fisheries agency review.⁴
- Experience in other jurisdictions, particularly Oregon (Robison 2001), has shown that closed bottom structures can be successfully installed when careful consideration is paid to site location conditions and structure design parameters. The embedment methodology (also known as stream simulation) consists of selecting a culvert (pipe) of adequate opening to encompass the stream channel width, and emulating the streambed within the culvert by lining the bottom with representative streambed substrate. The natural substrate materials are supplemented with additional larger material to help retain the substrate within the culvert and assist fish passage. By emulating the streambed and stream channel width, the culvert's streamflow characteristics should reflect the natural streamflow characteristics.

⁴ Alternatively, such application must be made to the Oil and Gas Commission concerning petroleum roads or the Ministry of Energy and Mines concerning mining access roads.

Culvert/streambed cross-section



Culvert/streambed cross-section

Culvert/streambed profile

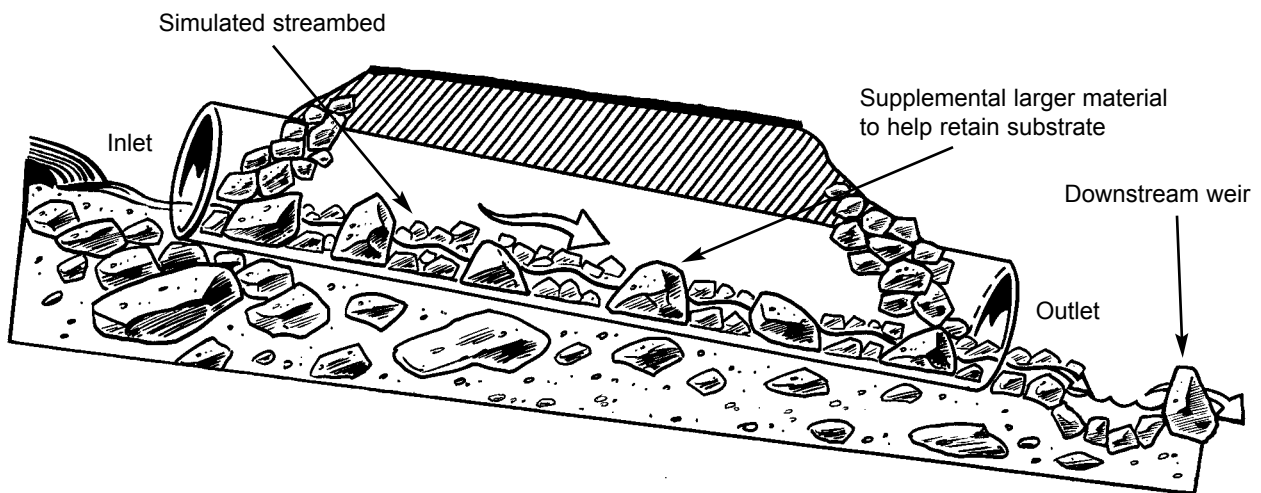

Figure 7. Typical closed bottom structures.

- The use of closed bottom structures in fish streams requires careful design and layout, paying particular attention to fish passage and fish habitat over the lifespan of the structure. The following requirements should be addressed.

Streambed profile determination:

- A detailed profile of the existing streambed using precise instruments is required for an extended distance upstream and downstream of the proposed crossing (approximately 50 m each way). Benchmarks for elevation and construction control should be established. The objective is to accurately model the streambed profile. This should assist in determining the culvert slope, invert elevation, and streambed. An example is provided in Figure 8. Streams that have bedrock outcrops or little variation in bed elevation should generally require shorter profiles. Existing pipes with local sediment retention or scour as a result of the culvert may require longer profiles to get beyond the zones of induced disturbance.
- A closed bottom structure should be designed and installed at the same slope as the stream (see Figure 8), and should retain the same stream substrate characteristics within the culvert. For migrating fish, this would impose no changes or stress, nor induce any delays at the crossing struc-

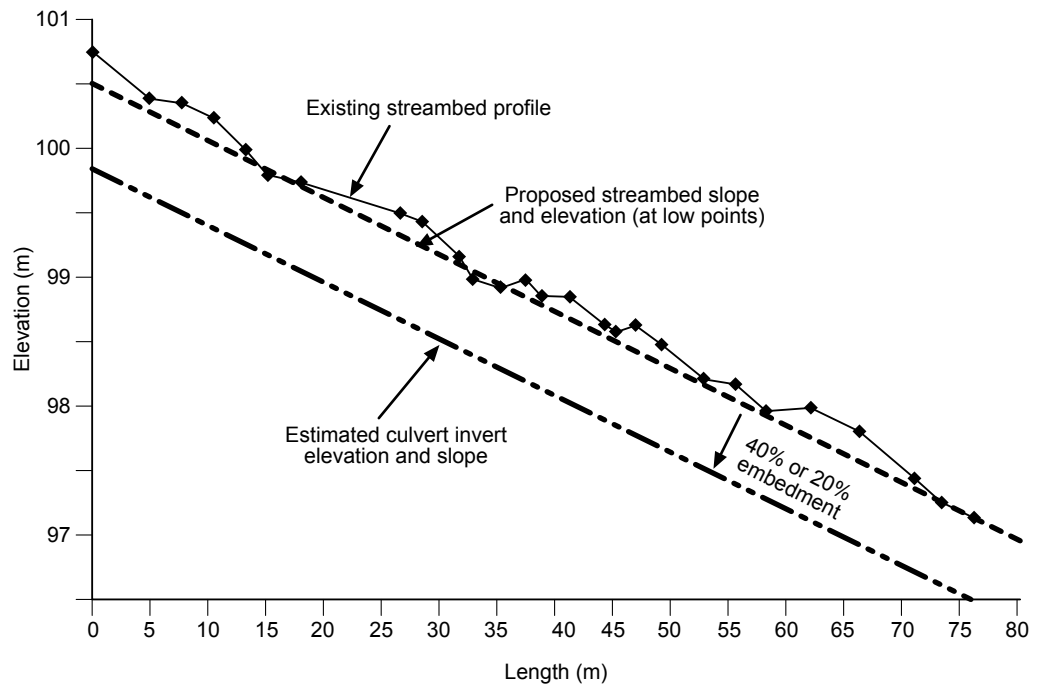

Figure 8. Stream elevation profile example for use in determining culvert slope and minimum invert level for an embedded culvert.

Note: 1. *The vertical placement of the culvert in relation to the overall stream longitudinal profile is extremely important. The culvert invert should be determined from the longitudinal profile of the streambed, ensuring that the culvert is located at a low point along the streambed profile. Special note should be made of any artificial or other non-permanent anomalies (such as large debris-holding or storing-bed material) that may not provide a suitable invert elevation.*

ture in upstream migration. Substrate transport should move through the culvert naturally, and there should be no sediment build-up upstream or deprivation downstream.

- Where practicable, the natural meander pattern of a stream should be retained. A closed bottom structure should not be placed in the bend of a stream, as this leads to bank erosion and debris problems. Where the above cannot be achieved, the crossing structure should be relocated or another chosen, such as an open bottom structure.

Pipe size:

- A systematic, objective methodology to measure stream channel width is presented in Appendix 1. The stream channel width should determine the required culvert diameter/width. The width of the replicated or simulated streambed within the culvert should be equal to or greater than the stream channel width, to emulate the natural stream and to prevent deposition, scouring, or other damage at the outlet. Figure 9 illustrates stream channel width.
- A closed bottom structure must be sized to accommodate the 100-year return period peak flow after embedment. This flow determination must be carried out, and the pipe enlarged if it cannot otherwise pass the 100-year design flow.
- Factors in determining the appropriate culvert length include: depth of fill, skew angle of the culvert to the road, gradient of the culvert, and required road width.
- The closed bottom structure should be properly designed to avoid letting side slope and backfill material enter the culvert or flow channel. Rip rap should be used to provide scour protection for materials potentially exposed to erosion.

Design embedment:

- For circular culverts, the embedment should make up at least 40% of the culvert diameter or 0.6 m, whichever is greater. For pipe-arch or box culverts, embedment depth should be at least 20% of the vertical rise of the arch.
- The vertical placement of the culvert in relation to the overall stream longitudinal profile is extremely important. The culvert invert should be determined from the longitudinal profile of the streambed, ensuring that the culvert is located at a low point along the streambed profile (as shown in Figure 8).
- The streambed should consist of sufficient layers of unconsolidated gravel, sand, cobble, and other sediment lying over the top of the bedrock to allow for proper embedment. If little streambed is available to be excavated, then culvert sinking and embedding strategies become impractical.

Substrate placement within the pipe:

- Knowledge of the type of material found in the natural streambed and a specification for replicating this material are critical to successful sub-

strate placement. As a general rule of thumb, the sizing of material placed within the culvert should be similar to the size of material in the adjacent natural stream channel. The “hydraulic roughness” of the culvert bottom is related to the size of bed material. Hydraulic roughness in turn is related to water velocities and water depth inside the culvert.

- Based on a design specification for gradation, the closed bottom structure should be filled with substrate material to the natural streambed level, using clean, well-graded material and supplemental material that is equal to or greater than the stream channel D90⁵ particle size. A heterogeneous mixture of various substrate sizes that contains enough fine material to seal the streambed is recommended. Where the streambed is not sealed, subsurface flow may result, creating a barrier to fish passage. It may be necessary to supplement the substrate by washing in sand and gravel to seal the bed. Wash the simulated streambed and intercept the sediment at the outlet of the pipe before it enters the stream.
- Where closed bottom structures are installed in streams with gradients between 3 and 6%, the physical placement of supplemental larger material (D90+) is even more important. Note that oversized material may be problematic, creating increased hydraulic roughness and flushing out fines through the poor gradation of the embedment materials. At these gradients, the pipe should be large enough to allow for the physical placement and orientation of these larger elements. This should assist in retaining substrate and preventing scour in the culvert. The design should note the dimensions and quantity of the additional larger material.
- A thalweg (low-flow channel) should be established through the culvert to enable fish passage at low flow.
- Where a structure is to be replaced and a gravel wedge has been stored above the structure, take steps to maintain the stability of the wedge.

3.2.2 Installation of closed bottom structures

- The steps below outline the general installation procedures for closed bottom structures as they apply to fish streams. See Appendix 4 for sample construction drawings of a typical closed bottom structure.

Assemble in advance:

Deliver all required materials and mobilize equipment in advance so the installation can proceed without delay on a dry bed within the timing window. Appropriate work site isolation techniques (see Section 4.6.1) should be employed during the closed bottom structure’s installation.

5 D90 is the largest size class of streambed substrate that may be moved by flowing water. Approximately 90% of the streambed substrate will be smaller than this size class.

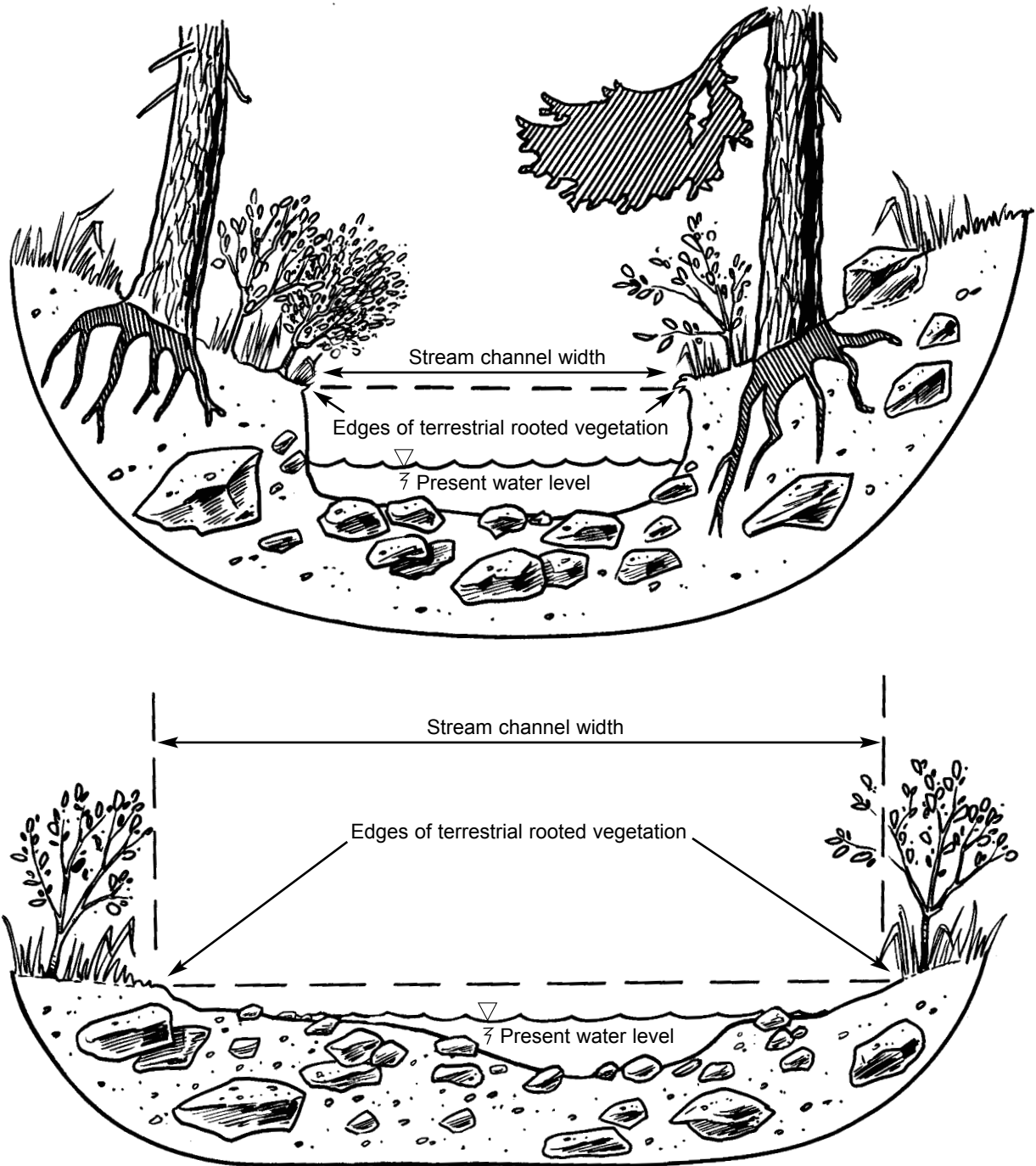

Figure 9. Determining stream channel width.

Survey:

- Lay out the work site with precise instruments, including establishing the horizontal and vertical field references to accurately locate the culvert invert elevation and slope during construction.

Bed preparation:

- Prepare and grade the culvert bed to conform to the design elevation and slope, using benchmarks and precise instruments. The barrel of the closed bottom structure should be set to the appropriate depth below the streambed and at the same natural stream gradient as shown by the longitudinal profile survey. The culvert foundation, trench walls, and backfill should be free of logs, stumps, limbs, or rocks that could damage or weaken the pipe.

Seepage barriers:

- Consider using geotextiles to prevent loss of fines and gravel through seepage along the culvert wall. The fabric, or other cut-off measures such as sandbagging or use of prefabricated seepage barriers along the culvert near the inlet, is intended to cut off most of the seepage and mitigate potential support fill erosion that can occur along the pipe.

Drainage:

- Do not allow side ditches to drain directly into the stream (see Figure 13). Divert ditchwater into a constructed sump or, where possible, onto stable forested vegetation that can filter sediments before the water reaches the stream. Ensure that adequate cross drainage is in place before the culvert approach to minimize the water volume directed into approach ditches at culvert sites. Consider the use of rolling grades to divert road surface runoff. Where cross-ditches are used, ensure that they are properly armoured at the outlet and along the base.

Constricting the stream:

- Do not allow any activities, including the placement of rip rap, to cause any constriction of the stream channel width.

Erosion protection:

- Begin erosion-proofing all exposed mineral soil as soon as possible after disturbance.

Downstream weir:

- An instream weir (see Figure 10) should be established within one and a half to two channel widths downstream of the culvert outlet, particularly for streams greater than 3% gradient, to retain substrate within the culvert and to prevent the formation of a plunge pool. The residual pool depth formed by this downstream weir should be less than 0.3 m.

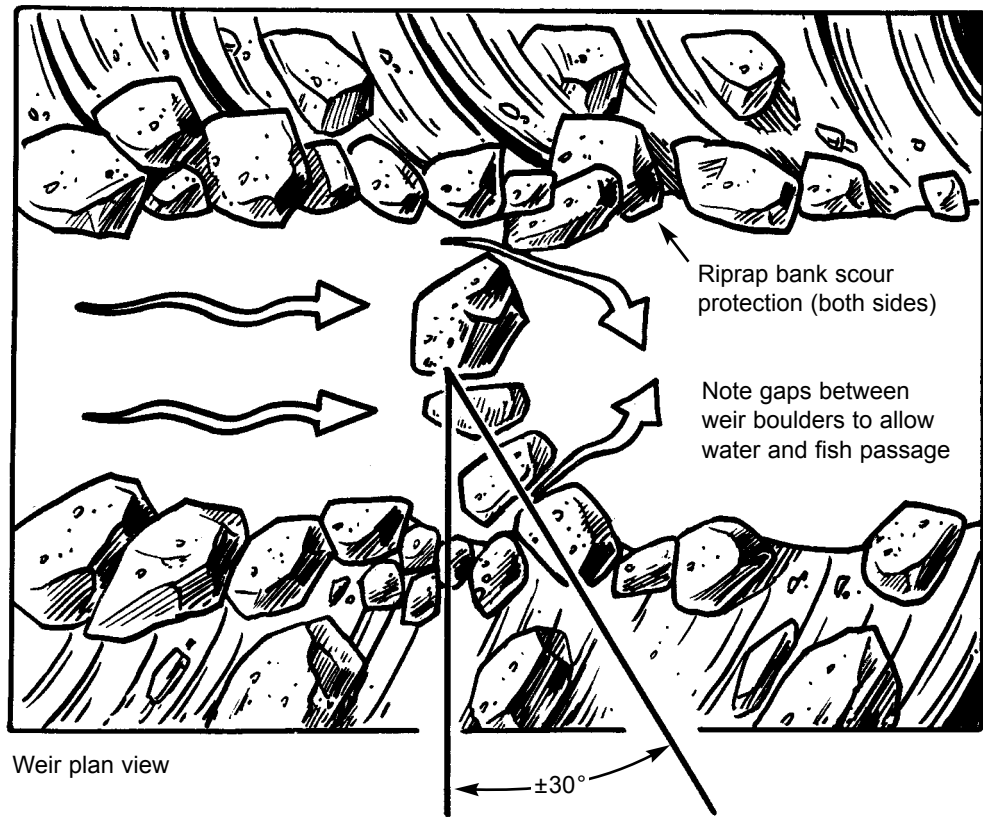

Weir plan view

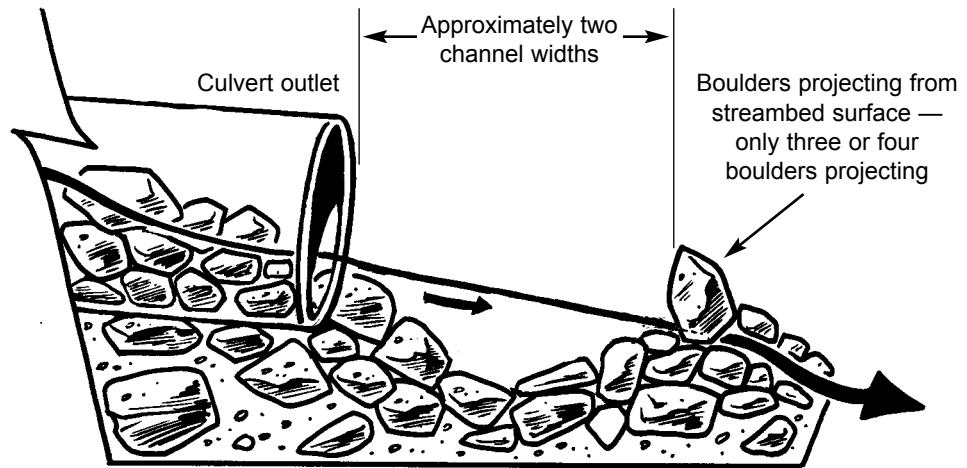

Weir profile view

Figure 10. Typical downstream weir.

Backfill:

- Backfill practices should conform to those specified by the culvert manufacturer, or otherwise specified by an engineer, and incorporate mechanical vibratory compaction immediately adjacent to the culvert (see Figure 11).

3–6% grade:

- For culverts installed at slopes greater than 3%, larger material (D90 or greater) should be mixed into the substrate to help retain the substrate in the pipe. The larger material should be placed so that it projects from the streambed. This should create velocity shadows to enhance fish passage, retain substrate, and simulate conditions in the natural stream.

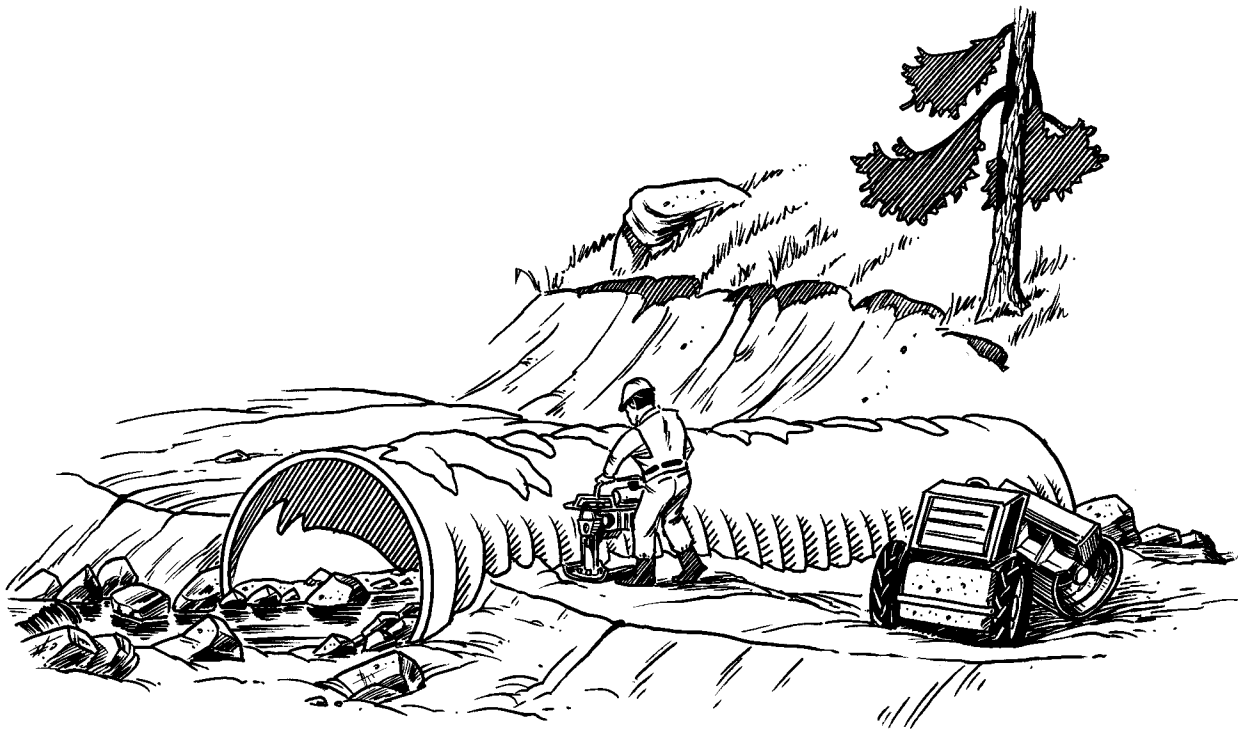

Figure 11. Culvert backfill compaction.

3.3 Snowfills

3.3.1 Design of snowfills

Snowfills (see Figure 12) are options that may be considered for seasonal use depending on the site, time of year, and other environmental constraints that may apply.

- Snowfills should be constructed and deactivated such that they should not affect fish or fish habitat at breakup. Deactivation is difficult and often results in channel disturbance as frozen material clings to logs.
- Snowfills are constructed by filling the channel with compacted clean snow (i.e., free of dirt and debris). Their use should be considered if the stream is dry or the water is frozen to the stream bottom. Unanticipated streamflow due to unseasonal thaws can be accommodated by log bundles or culverts. To avoid adverse impact on the stream, remove the log bundles, culverts, and snow prior to spring thaw.

3.3.2 Installation of snowfills

- The steps below outline the general installation procedures for snowfill as they apply to fish streams.

Construction period:

- Construct snowfill of dirt-free snow, only when there are sufficient quantities available for construction. Construction should begin after the stream has frozen solid to the bottom or the stream has ceased to flow, or when there is sufficient ice over the stream to prevent snow loading from damming any free water beneath the ice. Where possible, place snow into the stream channel with an excavator. Crawler tractors may be used to

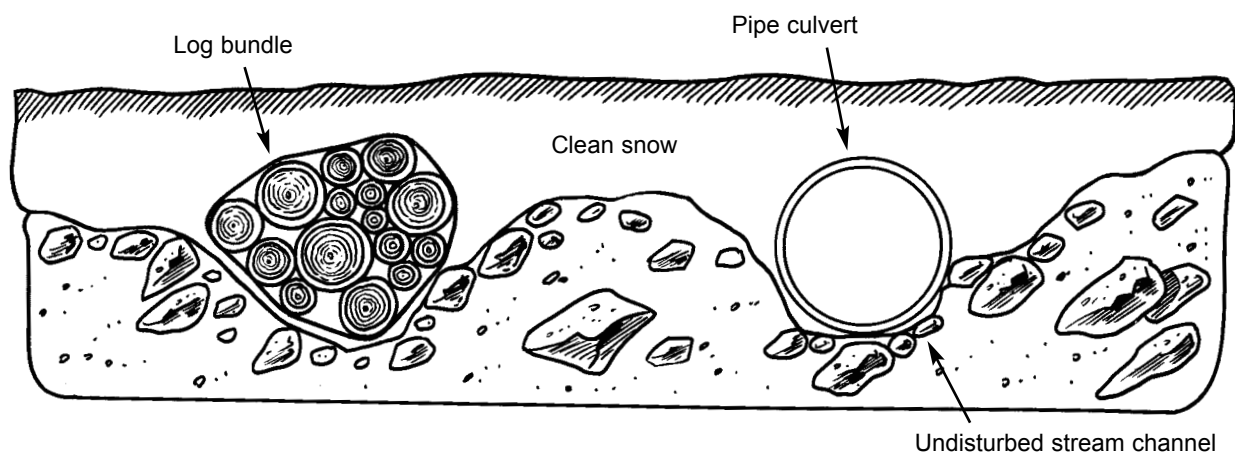

Figure 12. Temporary winter stream crossings using compacted snowfills. Culvert, heavy steel pipe, or log bundles allow meltwater to pass during warm weather trends.

push snow into the stream channel, but only if they can push snow unaccompanied by dirt and debris.

Streamflow:

- Where streamflow is anticipated during periodic winter thaws, place a pipe culvert, heavy steel pipe, or bundles of clean, limbed, and topped logs within the stream channel to allow for water movement beneath. The latter practice is not acceptable on streams where winter fish migration may be required. Heavy steel pipe is easier to salvage and has less chance of crushing under load and during removal.

Soil:

- Do not cap snowfill with soil. There is risk that soil placed within the stream channels could make its way into the stream during winter thaws.

Temporary removal:

- Remove any snowfill that may cause damage to the stream because of warmer weather, and reconstruct a new snowfill when colder weather returns.

Removal:

- Remove all snowfills and materials before the spring melt and place materials above the normal high water mark of the stream to prevent them from causing sediment and erosion. Deactivation should include the use of all appropriate measures to stabilize the site and facilitate its return to a vegetated state.

3.4 Ice Bridges

Ice bridges are effective stream crossing structures for larger northern streams and rivers, where the water depth and streamflow under the ice are sufficient to prevent the structure from coming in contact with the stream bottom (“grounding”), and where there are no concerns regarding spring ice jams. Grounding can block streamflow and fish passage and cause scouring of the stream channel.

3.4.1 Design of ice bridges

- Planning considerations in the design of ice bridges include depth of water, minimum winter daily streamflow, substrate, crossing location, maximum load strength, time of use, depth of ice required, approach construction, maintenance and monitoring, and decommissioning.

3.4.2 Installation of ice bridges

The steps below outline the general installation procedures for ice bridges as they apply to fish streams.

Reinforcing material:

- Determine whether using logs as reinforcing material could cause problems. There is a possibility that logs, if left in place through spring break-up, could contribute to debris jams and increase the risk of flooding, river channel alteration, erosion, and habitat loss. If this is an unacceptable risk, do not use logs. In most cases, log removal from a deteriorating ice bridge is an unsafe practice. The warmer weather and reduced ice thickness required to remove the logs can make working on the bridge unsafe for personnel and equipment. In these situations, removing all but the lowest logs from the ice bridge may be acceptable.

Thickness:

- Measure and record ice thickness and stream depth routinely. Evidence of grounding, or an increased risk of the ice base grounding with the streambed, may require that the bridge be temporarily or permanently decommissioned.

Approaches:

- Locate ice bridges where cutting into the streambank would be minimized during construction of the approaches. Remove all debris and dirt and place it at a stable location above the high water mark of the stream. Take steps to prevent it from eroding..
- Construct approaches of clean compacted snow and ice to a thickness that should adequately protect streambanks and riparian vegetation. Construction should begin from the ice surface. Where limited snow is available, locally available gravel from approved pits can be used to build up approaches, but should be removed when the ice bridge is deactivated.
- When it is time for deactivation, remove all ice bridge approaches. Where streambanks have been exposed to mineral soil, recontour and revegetate them using all appropriate measures to stabilize the site and facilitate its return to a vegetated state.

3.5 Fords

Fords, constructed as crossing structures, can result in habitat degradation through sedimentation, channel compaction, and the creation of barriers to fish passage. The construction of fords on fish streams is not encouraged by the authorizing agencies. When a ford is being considered, referral is required to the appropriate fisheries agency or the Oil and Gas Commission for petroleum-related operations, or the Ministry of Energy and Mines for mining projects.

4 Fish-stream Protection Measures

The practices described below apply to all fish-stream installations. Variations to those presented may be agreed to by the appropriate fisheries agency.

- The installation of a stream crossing should simulate conditions like those that existed before the structure in question was installed. Environmental objectives associated with the construction, installation, and use of stream crossings are:
 - protecting fish and fish habitat;
 - providing for fish passage;
 - preventing impacts on fish eggs and alevin that are present in the gravel, or on adult and juvenile fish that are migrating or rearing; and
 - reducing the risk of sediment release and other deleterious substances during work at stream crossings.
- To achieve those objectives, the following fish-stream protection measures are recommended:
 - Complete the work during the appropriate instream work window.
 - Eliminate or reduce sediment-related problems during installation.
 - Prevent deleterious substances from entering streams.
 - Minimize or avoid disturbing fish habitat above and below the area required for actual construction of the stream crossing.
 - Ensure that the design specifications for safe fish passage are achieved.
 - Revegetate and stabilize the site to prevent post-construction erosion.
 - Minimize clearing width at the crossing site and retain streamside vegetation within the stream crossing right-of-way wherever possible, recognizing operational requirements.

4.1 Vegetation Retention at Stream Crossings

- It is important to retain as much understory vegetation as possible within the riparian management area of the stream crossing to prevent erosion and minimize disturbance to fish habitat. Only the vegetation required to meet operational and safety concerns for the crossing structure and the approaches should be removed. Consideration should be given to salvaging rooted shrubs during crossing construction to assist in post-construction site stabilization.
- All efforts should be made to minimize impacts to the riparian fish habitat beyond the toes of the approach and abutment fills at the crossing site.

4.2 Falling and Yarding

- Falling and yarding of trees at stream crossings can result in unnecessary stream damage. Falling should be away from the stream whenever possible, and consideration should be given to the method of falling, tree removal, and stream cleaning (Figure 13) to minimize potential damage.
- Where construction work poses a risk of erosion and bank damage, directional falling and machine-free zones should be considered. Where leaning trees are encountered, consideration should be given to directional falling techniques. Where trees have to be felled across the stream for safety and operational reasons, trees should be lifted rather than dragged out.

4.3 Grubbing and Stripping

- Grubbing and stripping includes the removal of stumps, roots, and downed (non-merchantable) or buried logs. It should not be done in any area of the riparian management area not required for road construction, ditchlines, and installation of the crossing structure.

4.4 Slash and Debris

- All slash and debris that enters the stream channel from felling and yarding should be removed concurrently with site development. This material should be placed where it cannot be re-introduced into the stream by subsequent flood events. On most streams, this location is above the elevation of the active floodplain. Stream cleaning should not result in the removal of any hydraulically stable, natural debris. For additional information, see the Forest Practices Code *Riparian Management Area Guidebook*.
- All burying, trenching, scattering, or burning of debris should be done outside the riparian management area of the stream. Where this is not possible, debris piles should be located where they cannot enter the stream (i.e., not in active floodplain nor on steep slopes adjacent to the stream).

4.5 Fording

- The fording of fish streams is generally limited to one location and one crossing (over and back) for each piece of equipment required for construction on the opposite side. Where additional movements of equipment may be required, approval should be obtained from the appropriate fisheries agency regardless of habitat type.

- If the streambed and streambanks are highly erodible (e.g., dominated by organic materials, silts, and silt loams) and significant erosion and stream sedimentation or bank or stream channel degradation may result from heavy equipment crossings, then a temporary crossing, or other practices, should be used to protect the streambed and banks.

4.6 Erosion and Sediment Control Measures

Sediment delivered to stream channels can harm fish and fish habitat. Most sedimentation occurs in the first year when soils are exposed, during and immediately following construction. The amount of sediment generated at a stream crossing is directly related to the sensitivity of the soil to erosion, the amount of area exposed to runoff or streamflow, and the disturbance caused by road construction.

- Prevention of sedimentation by minimizing disturbance to streambanks and retaining riparian vegetation is essential. Many small streams and adjacent worksites are dry during the instream work window and construction can be undertaken without special measures for erosion and sediment control. When water is present, most erosion and sediment problems can be avoided through the use of a variety of methods that control sediment at the source and prevent it from becoming entrained in the flowing water. The key is to isolate the flowing water from the work site.
- During periods of heavy or persistent rainfall, work activities should be suspended if they could result in sediment delivery to the stream that would adversely affect aquatic resources. During such a shutdown period, measures to minimize the risk of sediment delivery to the stream should be implemented.

Common methods for reducing erosion during and after construction are described below.

4.6.1 *Work site isolation*

Working “in the dry” can greatly facilitate installation construction and reduce the amount of sediment produced during the work. To isolate a site, the following techniques should be considered:

- On small streams or where flows are very low, pipes, flumes, or erosion-proofed ditches may be adequate to divert flow around the site. To minimize sediment loss at these sites from and along the diversion, installation of sediment traps, combined with the use of geotextiles, is recommended.
- Temporary stream diversions should always be excavated in isolation from streamflow, starting from the bottom end of the diversion channel and working upstream to minimize sediment production. To prevent loss

of sediment, the bottom end of the diversion channel should be left intact until the trench is almost complete and it should not be opened until all measures have been taken to reduce surface erosion resulting from the channel. After the stream crossing has been completed, the diversion should be closed from the upstream end first and, on completion, actions should be taken to re-establish the pre-diversion conditions and to stabilize and revegetate the site.

- Where practical, water can also be pumped across the work site and discharged into the stream channel below the site. This technique requires the stream to be dammed above the construction site. This eliminates the need for a diversion channel, and thus greatly reduces the problems of sediment production associated with digging and operating a newly created stream channel. Pump intakes should be screened to prevent entrainment of juvenile fish. Backup pumps on site are highly recommended in all pumping situations.

4.6.1.1 Cofferdams

- Cofferdams may be required to isolate work from the streamflow. These structures should not reduce the stream channel width by an amount that could lead to erosion of the opposite banks or of upstream and downstream areas. Cofferdams can be constructed in various ways. For example, sandbags lined with geotextiles or rubber aqua dams can be used.
- All materials should be removed after construction is completed, and all water pumped from contained work areas within cofferdams should be discharged to a forested site to allow sediment to settle before the water re-enters the stream.

4.6.2 Fish salvage

- If channel de-watering is conducted, fish should be salvaged from the de-watered area and returned to the stream. The person undertaking the fish salvage operation should obtain and hold all necessary permits required by fisheries agencies to collect and transport fish. Fish salvage is the relocation of live fish from a work site to a safe location above or below the site. Salvage operations require the isolation of the work site and the collection and removal of all fish from areas where fish may be entrapped or destroyed by construction activities. Fish can be collected through the use of electrofishing equipment, small nets, and seines.

4.6.3 *Vegetation soil stabilization*

- Vegetation soil stabilization is the most cost-effective, long-term surface erosion control method because it controls sediment at the source. The Forest Practices Code requires that all mineral soil exposed during construction and installation of a stream crossing be revegetated following construction. Revegetation of approach ditches, cutslopes, and other disturbed areas reduces the possibility of stream sedimentation and should be undertaken immediately following completion of work. Standard revegetation techniques include hand-broadcast or hydraulic seeding, and mulching using regionally adapted seed and mulch mixes.

4.6.3.1 **Seeding and time of application**

- For information on regionally adapted seed mixes and procedures for seeding or planting vegetation, contact the B.C. Ministry of Forests, Forest Practices Branch, in Victoria. Seed mixes that are less palatable to livestock should be selected to minimize livestock activity at the crossing site.
- Time of seed application is determined largely by completion time of the stream crossing installation. It is recommended that all exposed soils in the vicinity of the stream crossing installation be seeded immediately following completion of construction, and that the site be re-seeded if necessary during the regularly scheduled road construction seeding program. Hydro-seeding is the most efficient means for seeding steeper slopes.
- Mulching accelerates seedling development and reduces the chance of seed being washed away by rainfall and runoff. When combined with hand-broadcast seeding, straw is a fast and cost-effective mulch substitute for dealing with smaller exposed areas near stream crossings. Seed and mulch can be applied by hand, independent of the seeding schedule, or by the method established for the rest of the road system. This practice can accelerate revegetation at higher-risk locations.
- Fibre-bonding agents are slurries of wood fibres and tackifiers that conform to the ground and dry to form a durable, continuous erosion control blanket that stays in place until vegetation is established. The fibre mats created are biodegradable and decompose slowly as vegetation is re-established. Like other forms of mulching, bonded fibre matrices hold seed and fertilizer in place, yet allow sunlight and plants to penetrate. Compared to conventional erosion control blankets, they require no manual labour to install and are not subject to under-rilling or tenting, as can occur with erosion control matting and netting.

4.6.4 Erosion control matting and netting

- Erosion control revegetation matting and seed overlain with a biodegradable netting material such as jute (woven fibres) are other effective methods for speeding germination and plant growth and holding materials in place. Stakes fix the matting or netting in place and can be made to overlie most slope angles adjacent to stream crossings. Jute netting may also be used to hold mulch and other materials in place, although it provides little if any soil protection.

4.6.5 Bioengineering solutions to erosion control

During and soon after construction, physical engineering solutions should be considered for erosion control (e.g., silt fences, straw bales), followed by bioengineering techniques. Examples of bioengineering solutions can be found in Polster 1997.

4.6.6 Rip rap

- Rip rap or a shot rock pad should be placed at the outlet of all cross drains where ditch water is being diverted from an approach ditchline and discharged onto erodible soils or fills. Ditches lined with rip rap, shot rock, or large gravel are an effective method for reducing erosion at approaches to stream crossings. Rip rap slows the velocity of ditch water and armours erodible ditch bed materials.
- All rip rap or rock used should be free of silt, overburden, debris, or other substances deleterious to fish. The material should be durable and sized to resist movement by streamflow. Where rip rap is not available, fabric linings can be used temporarily at approaches and culvert spillways.

4.6.7 Drainage control

- Drainage control is critical to the successful retention of sediments both during and after construction (Figure 13) and needs to be considered in relation to the existing drainage pattern on the site. A site sketch plan is the best tool to work with when developing a drainage control plan. The two most effective steps in reducing water-related problems are (1) reducing the volume of approach ditch water and (2) preventing ditch water from draining directly into the stream.
- To minimize these problems, cross-drain culverts should be placed in the road at a location that allows as much of the water to be diverted away from the stream crossing as possible. This minimizes the length of the approach ditch that contains water, and the amount of ditch open to erosion. Any berms that may be present should be breached and tail-out

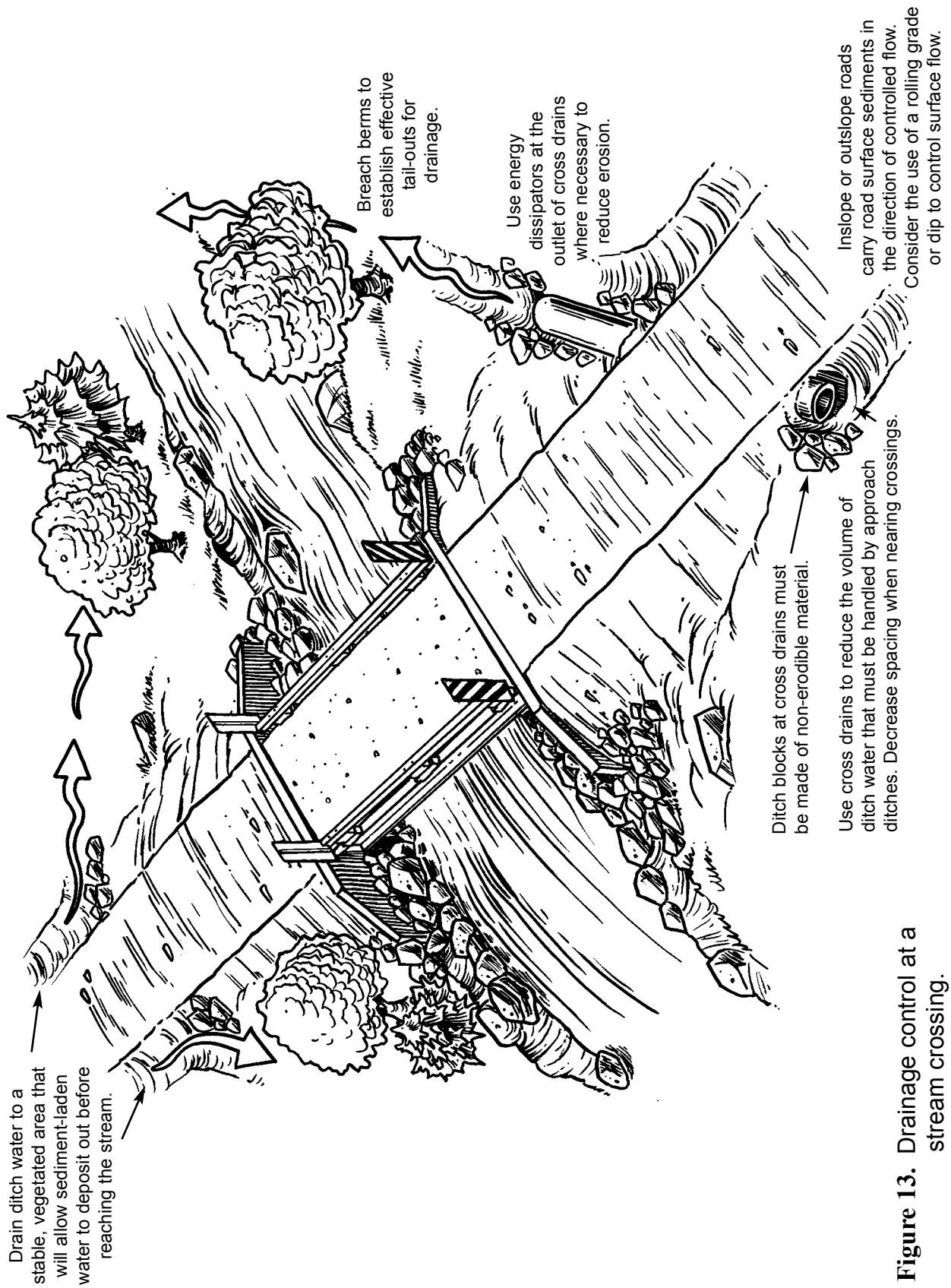

Figure 13. Drainage control at a stream crossing.

ditches dug to carry the water off the road clearing width. It is important to ensure that effective ditch blocks are present. These should be constructed of material sufficient to withstand the erosive forces of the anticipated amount of water carried by the ditch.

Draining ditch water directly into the stream should be avoided. As much ditch water as possible should be drained out of the ditch and into constructed sumps or onto vegetated areas that should allow ditch sediments to deposit out before the water reaches the stream.

4.6.8 Sediment traps and barriers

- Sediment should be controlled at the source. Once entrained in water, it is more difficult to control. Sediment traps and basins, silt fences, straw bale dikes and basins, and geotextiles provide effective means, used singularly or in combination, for controlling sediment during construction. Sediment traps and basins can be either simple, small pits or large, complex engineered structures designed to impound large quantities of sediment. Silt fences and straw bales, in contrast, are designed primarily to intercept and filter small volumes of “sheet flowing,” sediment-laden runoff before it reaches the watercourse. Silt fences, however, should never be used as filters within a watercourse, as they have limited capacity to pass water.
- On completion of construction, these temporary control structures should be removed and the sediment stabilized.

4.6.8.1 Sediment traps or basins

- Sediment traps or basins used on forestry roads are excavated pits that capture coarse sediments from ditchlines before they can enter a stream. All sediment traps and basins should be cleaned frequently while they are in place if they are to be effective. At the site of the crossing, ditch water should be directed into the sediment trap or basin.

4.6.8.2 Silt fences

- Silt fences are short-term structures made of wood or steel fence posts and a suitable permeable geotextile. They retain soil on the site and reduce runoff velocity across areas below the fence. Silt fences are effective boundary-control devices and can be used to intercept soil from cut-slopes and ditchlines, and to isolate the general work area from the stream. They are intended to prevent sediment entering channelized flows.
- After work is completed, silt fence structures should be removed carefully to prevent the sediment retained from entering the watercourse or being re-mobilized during the next rain event.

4.6.8.3 Straw bales

- Straw bales are best suited where temporary, relatively minor, erosion control is needed while more permanent solutions are being devised. When properly used, straw bales can be effective in intercepting sheet flow runoff at the base of an exposed cutbank, fillslope, or swale, or in acting as a check dam in the ditchline of a road. Proper use means not being stacked, and care should be taken to ensure that noxious weeds and non-native grasses are not spread as a result of using straw bales. Hay bales in particular generally contain the edible portion of grasses and more seeds than straw bales.

4.7 Handling Hazardous Substances

It is important to know and comply with all regulations governing the storage, handling, and application of substances that can be deleterious to fish, including wood preservatives, paints, fuel, lubricants, and fertilizers. See *Guidelines to Protect Fish and Fish Habitat from Treated Wood used in Aquatic Environments in the Pacific Region* for information on the proper use of wood preservatives.

- Uncured concrete or grout can kill fish by altering the pH of the water. Pre-cast concrete and carefully protected grout should be used to eliminate the risk to fish. However, when cast-in-place concrete is required, all work should be done “in the dry” and the site effectively isolated from any water that may enter the stream for a minimum of 48 hours.
- All fuels, lubricants, and other toxic materials should be stored outside the riparian management area of the stream, in a location where the material can be contained. Equipment should be checked for leaks of hydraulic fluids, cooling system liquids, and fuel, and should be clean before fording. All fueling operations should also be done outside of the riparian management area.
- A contingency plan should be developed for the use of all hazardous materials, including spill containment, clean-up, and notification of the appropriate regulatory agencies and water purveyors in the event of a problem. Spill kits, sorbents, and containers for disposal should be retained on site.

5 Maintenance Practices

All stream crossings and sediment control structures require inspection and maintenance.

- The frequency of inspections should be commensurate with the risk of damage to the structure from major storm or runoff events affecting the fisheries resource. Areas prone to serious debris or bedload problems require special consideration and should be accounted for in the choice of structure.
- Ongoing inspection and maintenance of stream crossings and control structures should be conducted on a regular basis to ensure that they:
 - protect fish and fish habitat;
 - maintain safe fish passage; and
 - reduce the risk of releasing sediment or other deleterious substances.
- It is good practice to clearly mark all crossings on fish streams, allowing maintenance staff to readily identify them. Where the operation has a road inventory system, all fish-stream crossings should be marked on the map or electronic database.
- Standard operating procedures relating to road maintenance should be developed and implemented.
- If inspection reveals ongoing maintenance problem, then consideration should be given to the redesign and replacement of the structure to meet fish passage and fish habitat objectives.

5.1 Bridges

- Remedial bridge maintenance activities that do not alter fish habitat, such as painting or sandblasting, may be conducted in accordance with the *DFO-Habitat Guidelines for the Protection of Fish and Fish Habitat During Bridge Maintenance Operations in British Columbia*.
- Large-scale maintenance activities such as dredging or the placement of rip rap or fills below the high water mark usually constitute changes in and about a stream that may result in alteration to fish habitat. Applications describing these works and activities should be submitted to review agencies.
- Gravel and sediment can get dragged onto the bridge from routine grading. Care should be exercised to prevent this gravel and sediment from entering the stream either directly from the bridge surface or indirectly from material pushed over the edge along the approaches. There are several methods that can be used to address this issue:

- Gravel guards can be installed along the edge of the bridge rails to prevent the gravel and sediment from entering the stream. The bridge rails typically have open spaces between the fasteners of the rail where sediment can enter the stream.
- Approaches can be paved.
- Curbs can be installed along the bridge approaches.
- Grading away from the bridge can be done.

5.2 Open and Closed Bottom Culverts

- Culverts should be inspected to ensure they provide safe fish passage and protect fish and fish habitat above, below, and at the culvert. Inspections should be conducted immediately before the period of seasonal high stream flows, following any major storm event and, safety permitting, during these flows or events. All installations should be checked to ensure they are functioning following construction and seasonal deactivation.
- Maintenance problems with culverts should be rectified as soon as possible to restore normal function and prevent damage to the site or stream. All instream work required to rectify major problems should be done following the recommendations given in Section 4 to prevent further impacts to the watercourse. If instream work cannot be avoided, then application should be made to regulatory agencies as appropriate.
- The following common concerns related to culverts should be addressed:

Substrate:

Closed bottom culverts constructed in accordance with this guidebook should be embedded to retain stream substrate. If inspection reveals that substrate is not being retained, original design parameters should be re-evaluated. Simply replacing streambed substrate within a culvert is not acceptable as it may affect downstream fish habitat by causing pool infilling. The design discharge must also be maintained. An outlet control such as a weir may facilitate substrate retention. Some large rock may be added to the substrate within the culvert barrel in an interlocking manner to ensure that substrates are retained.

When water is flowing in the stream, the depth of water in the pipe above the substrate should be similar to the depth upstream and downstream of the culvert. It may be necessary to add one or more weirs to a culvert to help retain the substrate within the culvert and so ensure that the stream flows above the substrate, particularly at low flows.

Fish passage:

Several problems arise with non-embedded closed bottom structures. One of the most serious is scouring at the outlet, which results in a pool with a

perched outlet. This frequently renders the structure impassable to fish. New embedded culvert design and construction techniques should avoid this problem. However, where proponents have responsibilities under the Forest Practices Code for existing culverts built prior to June 15, 1995 that lack fish passage capability, the culverts should be assessed and appropriate actions taken to restore fish passage. This may require reconstruction of the culvert or modification of the site by backwatering or through baffle or weir installation to achieve passage flows.

Where baffles or weirs are proposed, specific biological and engineering input is required. All retrofitted culverts should be inspected to ensure they are functioning. Baffles and weirs are prone to clogging with debris and sediment, and can be ripped out, damaging the culvert or even causing it to fail. They are also known to disrupt the boundary layer, resulting in impaired juvenile fish passage.

Plugging from upstream debris:

Culverts should be cleared of debris as soon as possible. Small accumulations of debris should be removed by hand. Properly designed “trash racks” should be built to accommodate fish passage. These may require frequent maintenance. If debris is a persistent problem, then replacement of the structure to permit natural bedload and debris movement should be considered.

Beaver dams at the inlet:

Beaver dams can prevent fish passage as well as threaten roads. Frequent maintenance is required. Beaver problems can be so persistent in some areas as to be a significant factor in design choice. Bridges are less prone to beaver problems than culverts.

Icing:

In northern areas where ice blocks a culvert and threatens to flood a road, modification of inlet conditions or de-icing (through the use of steam) may be required.

5.3 Sediment Control

Sediment control is an issue when maintaining roads near fish streams. For example, cleaning ditches adjacent to the stream, or grading or cleaning the deck of a crossing structure, can result in the deposit of sediment into a fish stream. During maintenance operations:

- Instruct grader operators not to blade material into streams. Alternatively, consider the use of containment logs to prevent sediment entering the streams.
- Maintain the existing vegetation inside the ditch closest to the stream to allow for filtering of sediment.

As well:

- Ensure that cross-drains and ditch blocks are functioning and road ditches continue to discharge as designed. Inspect all drainage areas to ensure sediment-laden water is being discharged appropriately and not eroding a new channel to the stream.
- Maintain vegetation by hydro-seeding or dry seeding and fertilizing, or by placing sediment and erosion control matting over road cuts and fills where problems are seen to occur. Spot seeding to fill in gaps left during seeding programs is quick, easy, and extremely effective in controlling small problems before they become large.
- Where possible, ensure that ditch outflows near the crossing discharge onto a vegetated area, or into a sump or other sediment control device, and not directly into the stream itself.
- Maintain or re-install permanent erosion control measures installed at the time of construction. Additional structures may be required to adequately control sediment.

6 Deactivation Practices

Environmental impacts associated with the deactivation of stream crossings (including the deactivation of old sites adjacent to a new crossing) can be avoided or mitigated by activities that:

- protect fish and fish habitat;
 - provide for fish passage;
 - prevent impacts to fish eggs and alevin that are present in the gravel, or on adult and juvenile fish that are migrating or rearing; and
 - reduce the risk of releasing sediment and other deleterious substances during work at stream crossings.
-
- Barring specific access planning objectives to close a road, crossing structures should be retained where continued access is required after deactivation.
 - The objectives behind stream crossing deactivation are (1) to restore the original habitat components to pre-crossing conditions, and (2) to close the road to future access. These conditions can be observed in the nearest unmodified section of the stream immediately upstream or downstream of the crossing.
 - When planning for deactivation is under way, all crossings where the stream gradient is less than 20% should be considered as fish streams unless specifically identified as being non-fish streams. Thus, a more detailed deactivation plan that takes fish protection into account typically should be prepared. The assumption is that if culverts are removed and the stream channel is re-configured, fish passage should be ensured, as long as the deactivation is carried out correctly.
 - Deactivation around fish streams can create special problems. The largest is the control of sediment from deactivation operations. As with construction, deactivation requires a sediment control plan and good implementation. Care should be taken to safely place the fill removed during deactivation; end hauling may be necessary. To prevent sedimentation, all work should be performed “in the dry,” habitat features should be restored, and the resulting channel should stabilize before water is re-introduced to the restored channel.
 - Many of the guidelines outlined in construction practices (Section 4) also apply to deactivation activity. Particular attention should be paid to those guidelines that relate to sediment control and revegetation.

Appendix 1. Methodology for determining stream channel width

Stream channel width is the horizontal distance between the streambanks on opposite sides of the stream, measured at right angles to the general orientation of the banks. The point on each bank from which width is measured is usually indicated by an observable change in vegetation and sediment texture. This border is sometimes shown by the edges of rooted terrestrial vegetation. Above this border, the soils and terrestrial plants appear undisturbed by recent stream erosion. Below this border, the banks typically show signs of both scouring and sediment deposition.

Recommended approach (see Figure 9)

- Avoid making stream width measurements at unusually wide or narrow points along the stream, or in areas of atypically low gradient such as marshy or swampy areas, beaver ponds, or other impoundments.
- Avoid measuring channel width in disturbed areas. Channel widths can be increased greatly by both natural and human-caused disturbances. These disturbances include those caused by recent exceptional flood events, debris torrents, machine and yarding, and even existing crossing structures. (See the Forest Practices Code *Riparian Management Area Guidebook* for descriptions of disturbed channels.)
- To determine the stream channel width at the crossing site:
 1. Use fibre survey chain at least 50 m long. Include all unvegetated gravel bars in the measurement (these usually show signs of recent scouring or deposition).
 2. Where multiple channels are separated by one or more vegetated islands, assume the width is the sum of all the separate channel widths. Exclude the islands from the measurement.
 3. Calculate the width of the stream reach by averaging at least six separate width measurements taken at equally spaced intervals along a 100-m length of the stream profile (i.e., 50 m upstream and downstream of the crossing site).
 4. Always determine the undisturbed channel boundary. If there is evidence of disturbance, consult with the local resource agencies on the appropriate stream width to use:
 - move either upstream or downstream to points along the stream that do not show signs of disturbance (e.g., where banks are not eroded); or
 - use the boundary of recently recolonized vegetation (e.g., alder, aspen, cottonwood).

Appendix 2. Instream work window for provincial fisheries zones*

Fisheries zones

Species**	Area 1	Area 2	Area 3	Area 4	Area 5	Area 6	Area 7	Area 8	Area 9
Chinook salmon	Jul 15-Sep 15	Jun 15-Jul 31	N/A	Jun 15-Jul 15	Jun 15-Jul 31	Jun 01-Jul 31	N/A	N/A	May 01-Jul 31
Coho salmon	Jun 15-Sep 15	Jul 01- Sep 30	N/A	Jun 15-Sep 30	Jul 01-Aug 31	Jun 15-Aug 15	N/A	N/A	Apr 01-Aug 15
Pink salmon	May 01-Aug 15	Jun 01-Aug 31	N/A	Jun 15-Aug 31	May 15-Aug 15	May 15-Aug 15	N/A	N/A	Mar 15-Jul 31
Chum salmon	May 15-Sep 15	N/A	N/A	N/A	May 15-Aug 31	May 15-Aug 31	N/A	Jul 01-Aug 15	Apr 01-Sep 15
Sockeye salmon	Jun 01-Sep 15	Jun 01-Jul 31	N/A	Jun 15-Jul 15	Jun 15-Jul 15	Jun 15-Jul 31	N/A	N/A	Apr 01-May 31
Kokanee	Jun 15-Jul 31	May 15-Aug 31	Jun 15-Aug 15	Jun 01-Aug 31	Jun 15-Jul 15	Jun 15-Jul 31	Jun 01-Aug 31	N/A	N/A
Steelhead	Aug 01-Nov 15	Jul 15-Oct 30	N/A	Aug 01-Apr 30	Aug 15-Dec 31	Aug 15-Nov 15	N/A	N/A	Aug 15-Nov 15
Rainbow trout	Aug 15-Nov 15	Aug 15-Sep 30	Jul 15-Mar 31	Jul 15-Apr 15	Aug 15-Jan 31	Aug 15-Jan 31	Jul 15-Mar 31	Jul 15-Mar 31	Sep 01-Apr 30
Curthroat trout	Aug 01-Sep 30	Aug 15-Apr 15	Sep 15-Apr 30	N/A	Aug 15-Dec 31	Aug 15-Dec 31	N/A	N/A	Sep 01-Apr 30
Dolly Varden	Jun 01-Sep 15	N/A	Jun 15-Aug 15	Jul 15-Aug 31	Jun 15-Aug 31	May 15-Aug 31	Jun 01-Aug 31	Jun 01-Aug 31	Jun 15-Aug 31
Whitefish	Jun 01-Sep 15	Jun 01-Sep 15	Apr 01-Oct 31	Jun 01-Sep 15	Jun 01-Sep 15	N/A	Jun 15-Aug 31	Jun 15-Aug 31	Jun 01-Aug 31
Arctic grayling	N/A	N/A	N/A	N/A	N/A	N/A	Jul 15-Mar 31	Jul 15-Mar 31	Jul 15-Mar 31
Walleye	N/A	Jul 30-Apr 01	N/A	N/A	N/A	N/A	Jul 01-Apr 30	Jul 01-Apr 30	N/A
Pike	N/A	N/A	N/A	N/A	N/A	N/A	Jul 01-Apr 30	Jul 01-Apr 30	N/A
Bull trout	N/A	Jul 01-Jul 31	Jun 15-Aug 15	Jun 15-Aug 15	Jun 15-Aug 31	N/A	Jun 15-Aug 15	Jun 15-Aug 15	Jun 15-Aug 31

* Instream work windows are approximations for a particular species over an entire specified area and should be considered time periods of reduced risk only.

** Not a complete list of species of concern. Proponent should consult regional fisheries staff with regard to species not listed here.

Appendix 2a. Map of provincial fisheries zones



Appendix 3. Example of a proponent application plan for a stream crossing project

Fisheries mitigation plan for embedded culvert installation at KM 45 on FSR 22

1. Fisheries Resource Values

An assessment of the fish habitat values involved the following procedures:

- a review of existing fisheries databases
- a detailed habitat inventory and a physical site survey
- fish sampling

(refer to Fish-stream Crossing Guidebook for methods for identifying fish streams and fish sampling procedures)

a) Review of existing fisheries databases

The Fisheries Information Summary System (DFO 2001) database identified coho salmon within 250 m downstream of the crossing location in Coho Creek. As there are no barriers and the habitat contains rearing and some spawning opportunity, coho are also likely to use the system. There is a total of 1.5 km of upstream fish habitat before a steep bedrock waterfall of approximately 20 m creates an access barrier to fish.

b) Detailed habitat inventory

Fish habitat was inventoried 100 m upstream and 100 m downstream of the crossing location. Stream profiles are provided in Appendix XX. The average gradient of the channel is 3% over the 200 m stream reach sampled. The average channel width is 1.6 m and the average channel depth is 0.5 m.

A detailed fish habitat assessment (WRP Tech Circ. #8 1996) was also conducted for the stream reach in which the crossing is to be located. The channel type was identified as a Riffle-Pool (RPcw), moderately degraded.

The proposed crossing location contains two pools. Pool #1 is 2 m long and 1.5 m wide with a residual depth of 0.7 m. Pool #2 is 2.5 m long and 2 m wide with a residual pool depth of 1.1 m. A gravel riffle separates the pools. Four pieces of large woody debris control gravel transport downstream. Three pieces of LWD are suspended above the channel and are serving as cover. One undercut bank 3 m long incised 0.5 m exists on the west side of the channel (See photographs in Appendix XX).

c) Fish sampling

Fish sampling was conducted in the stream reach at the proposed crossing site. Baited minnow traps were set for a 24-hour time period. The species identified are shown in Table 1.

Table 1. Summary of fish captured by minnow trapping. Fish sampling was conducted in April 2001.

Species	Number	Fork length (mm)
Chinook salmon	2	82, 76
Rainbow trout	4	60, 55, 45, 55
Largescale sucker	1	95

d) Habitat value at the location of the proposed crossing

Fish habitat in this reach is used for rearing and overwintering and is classified as important according to the *Fish-stream Crossing Guidebook* (2002).

2. Description of Proposed Activities

Installation of an embedded closed-bottom culvert is proposed for this crossing. Design drawings and the methods for installing the structure are provided in Appendix XX.

Instream works includes excavation of the streambed and streambanks for the installation of the culvert. The Designated Environmental Official Timing Windows and Measures Document establishes August 15–September 1 as the preferred instream work window.

3. Impacts to the Fisheries Resources

Streambed: Excavate the streambed to install the culvert.

Streambanks: Streambanks may be permanently altered at the site of the crossing and 5 m upstream and 5 m downstream of the crossing. The undercut bank on the west side may be permanently lost.

Riparian vegetation: Riparian vegetation may be permanently altered at the site of the crossing and 5 m upstream and 5 m downstream of the crossing.

Large woody debris: Four pieces of large woody debris should be lifted out of the channel to accommodate installation of the culvert. This wood is functioning as a cover feature for fish and as a long-term carbon source to the stream.

Sedimentation: Mineral soil may be exposed during grubbing and stripping with the potential to enter the stream. Sediment control plans are included in Section 4 below.

Fish passage: Temporary blockage of fish passage may occur for 3 days during installation.

Stream channel configuration: No changes are predicted to downstream flows or streambanks upstream or downstream of the crossing.

4. Mitigation Proposed

Streambed: A simulated streambed should be placed in the culvert post construction following the methods contained in the *Fish-stream Crossing Guidebook* (2002). Where feasible, larger streambed substrates removed during site preparation should be sorted and re-used to line the culvert.

Streambanks: Streambanks should be stabilized 5 m upstream and 5 m downstream of the crossing using larger boulders and rip rap. Streambanks should be restored to pre-disturbance condition upon removal of the culvert (based on Photograph XX).

Riparian vegetation: Riparian vegetation, mostly shrub and herbaceous vegetation, should be replanted adjacent to the culvert to provide shade and nutrients 5 m upstream and 5 m downstream of the crossing. Riparian vegetation should be restored to pre-disturbance condition upon removal of the culvert (based on Photograph XX).

Large woody debris: The four pieces of large woody debris that were lifted out of the channel to accommodate installation of the culvert should be replaced downstream of the culvert. They should be placed above the high water mark, over the channel, to prevent altering the channel downstream and should function as a cover feature.

Sedimentation: Introduction of sediments and contaminants should be avoided by isolating the worksite using a dam and pump system. Sediment control is described in the sediment control plan attached as Appendix XX.

Fish passage: Permanent fish passage should be restored within 4 days after installation. Fish passage should be achieved for the lifespan of the project and should be restored after removal of the structure.

5. Environmental Monitoring

XX contractor should undertake environmental monitoring. This individual should have powers to stop work if any activities lead to sediment entering the stream or if any other activities may harm fish habitat.

The environmental monitor should photographically record with dates and times the three phases of the project:

- streambed preparation
- culvert installation and substrate placement
- resumption of channel flow within the culvert

This record should be available upon request from agencies monitoring the works.

Appendix 4. Example construction drawings for an embedded round culvert

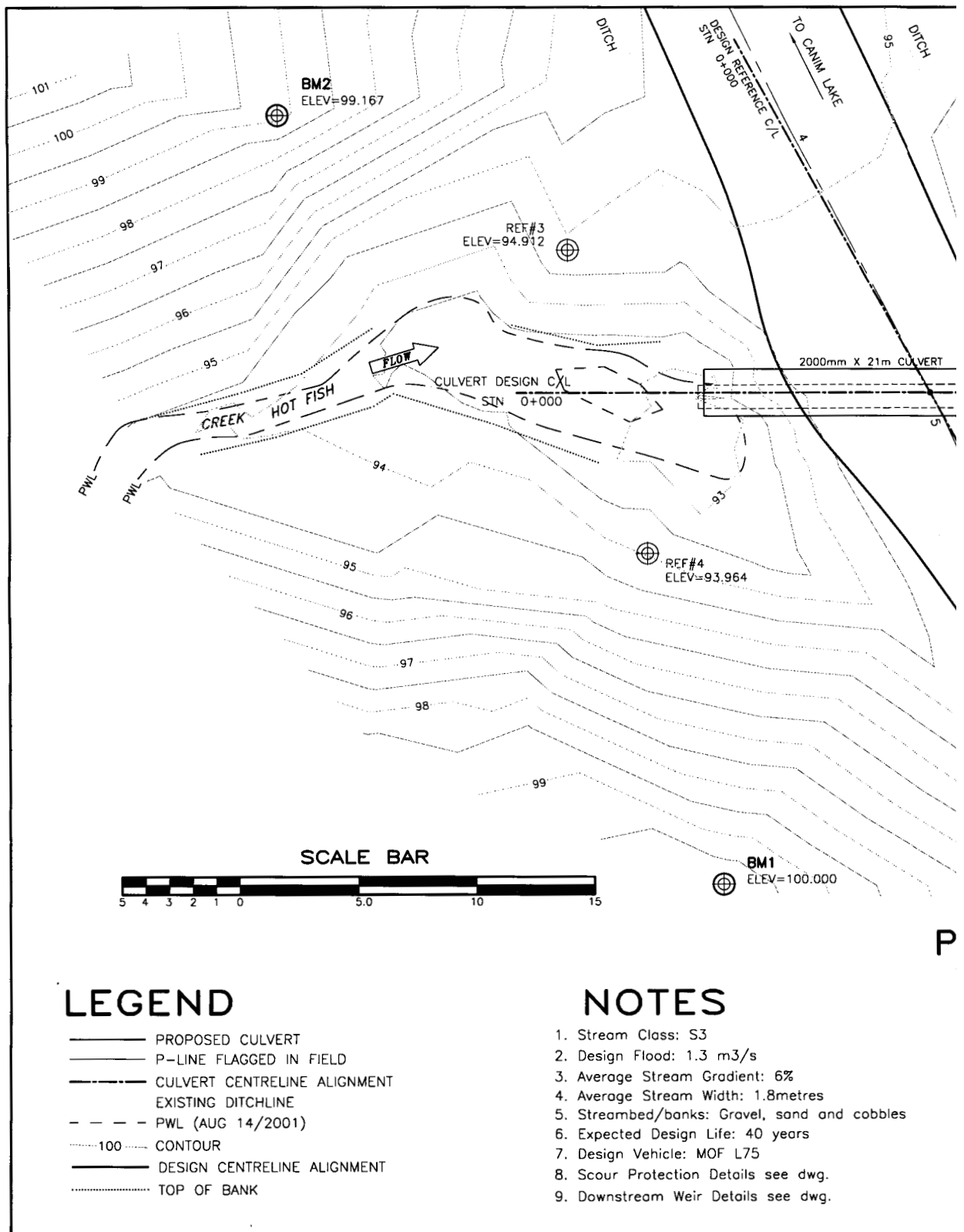

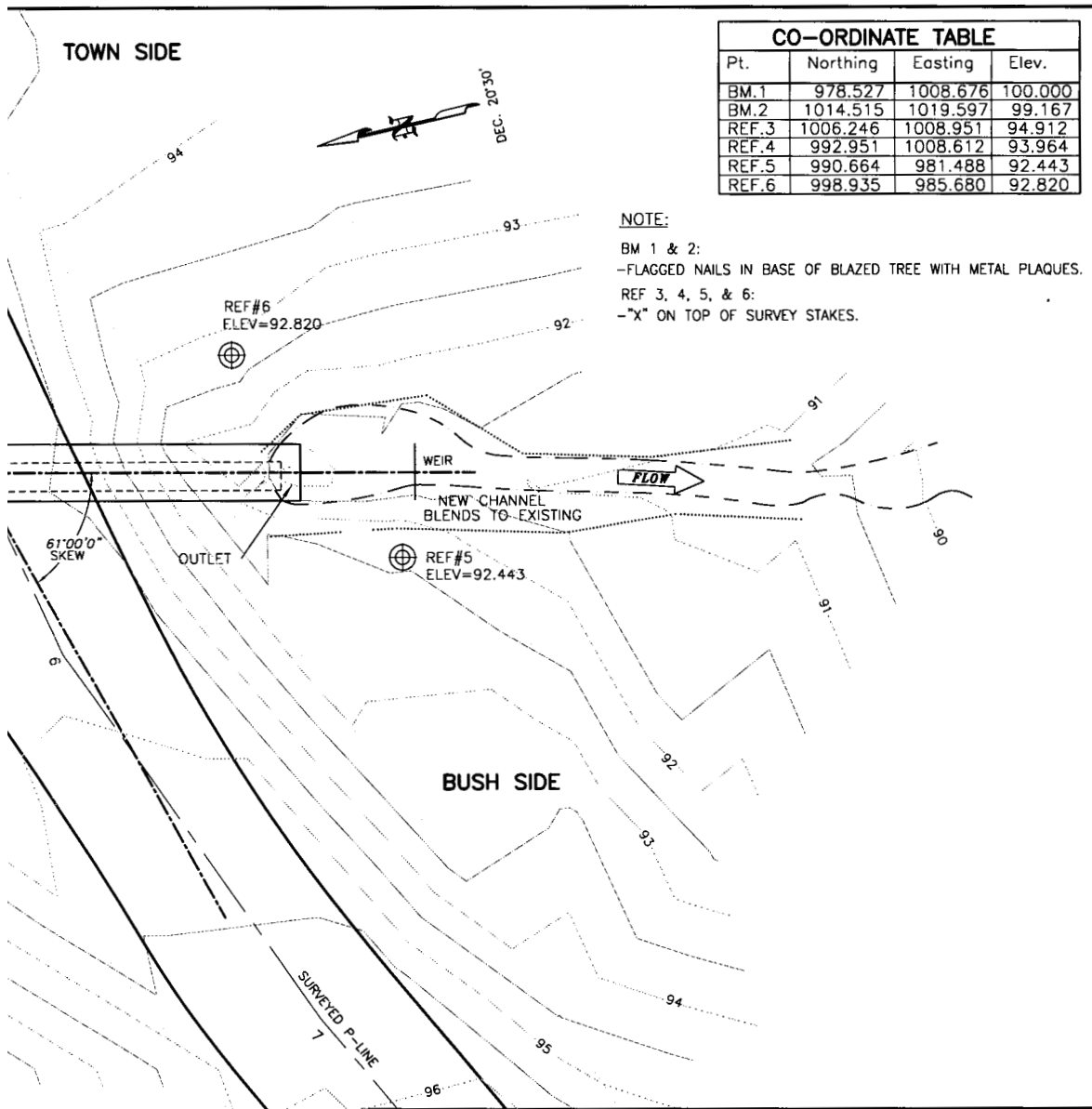

CO-ORDINATE TABLE			
Pt.	Northing	Easting	Elev.
BM.1	978.527	1008.676	100.000
BM.2	1014.515	1019.597	99.167
REF.3	1006.246	1008.951	94.912
REF.4	992.951	1008.612	93.964
REF.5	990.664	981.488	92.443
REF.6	998.935	985.680	92.820

NOTE:
 BM 1 & 2:
 -FLAGGED NAILS IN BASE OF BLAZED TREE WITH METAL PLAQUES.
 REF 3, 4, 5, & 6:
 -"X" ON TOP OF SURVEY STAKES.

LAN
 1:200

SCALE: AS NOTED (Metric)		PROJECT No.	STRUC. No.
SITE PLAN			
			Survey:
			Design:
			Drawing:
0	FOR CONSTRUCTION		DWG No.
REV.	DESCRIPTION	BY	APPD DATE

SHEET 1 OF 5

Appendix 4. (continued)

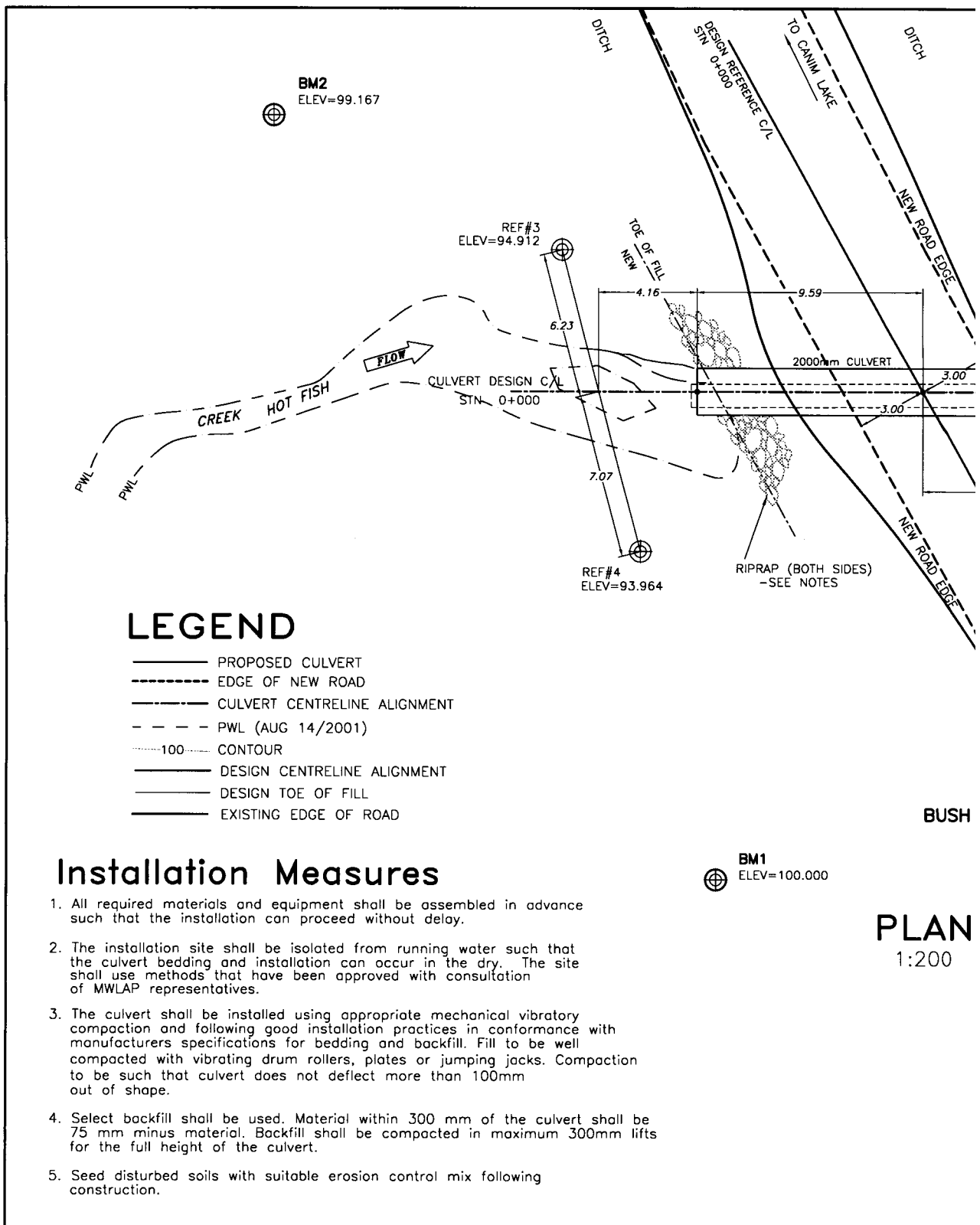

LEGEND

- PROPOSED CULVERT
- EDGE OF NEW ROAD
- CULVERT CENTRELINE ALIGNMENT
- - - - PWL (AUG 14/2001)
- 100 CONTOUR
- DESIGN CENTRELINE ALIGNMENT
- DESIGN TOE OF FILL
- EXISTING EDGE OF ROAD

BUSH

Installation Measures

1. All required materials and equipment shall be assembled in advance such that the installation can proceed without delay.
2. The installation site shall be isolated from running water such that the culvert bedding and installation can occur in the dry. The site shall use methods that have been approved with consultation of MWLAP representatives.
3. The culvert shall be installed using appropriate mechanical vibratory compaction and following good installation practices in conformance with manufacturers specifications for bedding and backfill. Fill to be well compacted with vibrating drum rollers, plates or jumping jacks. Compaction to be such that culvert does not deflect more than 100mm out of shape.
4. Select backfill shall be used. Material within 300 mm of the culvert shall be 75 mm minus material. Backfill shall be compacted in maximum 300mm lifts for the full height of the culvert.
5. Seed disturbed soils with suitable erosion control mix following construction.

BM1
ELEV=100.000

PLAN
1:200

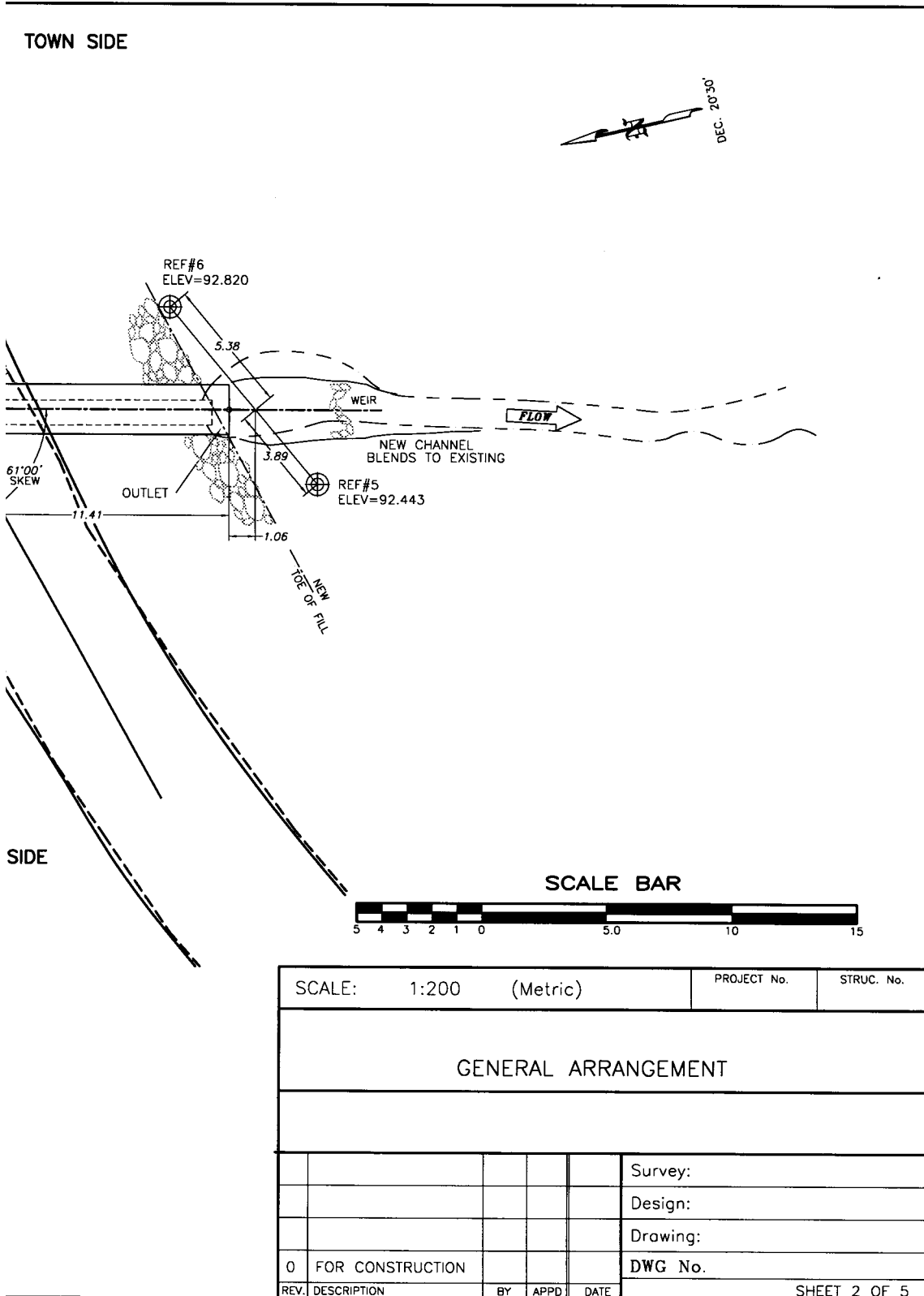

SCALE: 1:200 (Metric)		PROJECT No.	STRUC. No.
GENERAL ARRANGEMENT			
			Survey:
			Design:
			Drawing:
0	FOR CONSTRUCTION		DWG No.
REV.	DESCRIPTION	BY	APPD DATE
			SHEET 2 OF 5

Appendix 4. (continued)

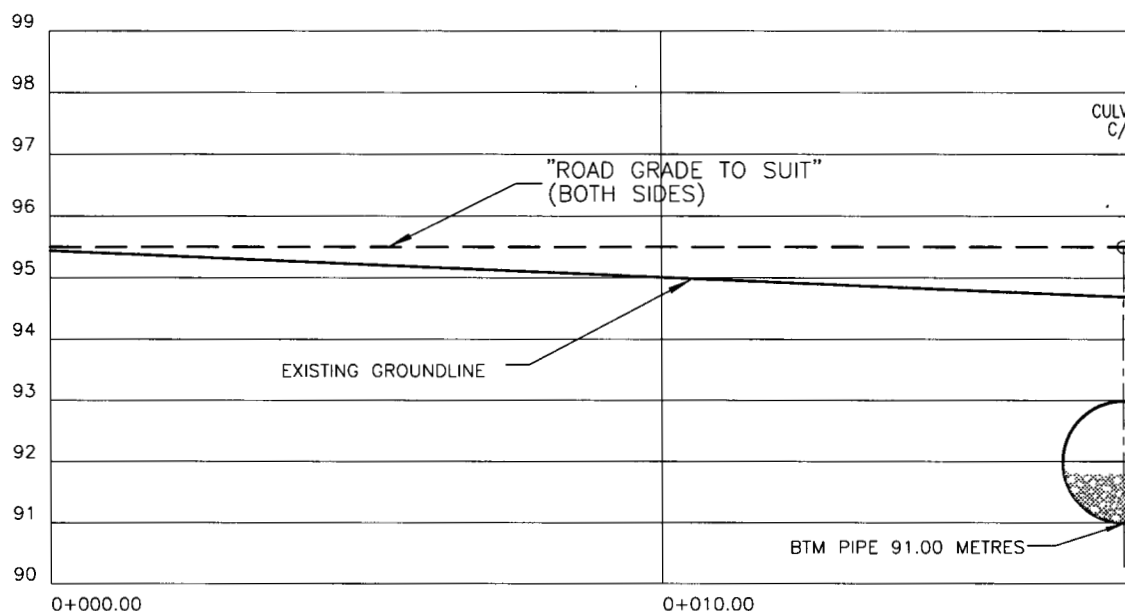

PROPOSED ROAD CE

(61'00" SKEW TO CU
SCALE HOR 1:100

NOTES

Specific notes regarding substrate to be utilized in the culvert should be noted in the design. The specifications for the material should note size, type and gradation. For steeper streams, the streambed material specifications should note specifications for supplemental larger material (i.e. D90) which would be incorporated to assist in retaining substrate in the embedded culvert.

1. An objective is for the backfill in the culvert to simulate the natural streambed.
2. If suitable materials for backfilling the culvert are not available on site, suitable materials shall be imported.
3. The backfill in the culvert to installed to the design streambed level using clean gravel, cobbles of similar size and distribution as in the natural streambed.
4. Substrate material to be imported into culvert to a nominal depth of 800mm (40% of culvert diameter) using suitable methods.
5. All voids in the substrate shall be filled in with clean sandy gravels.
6. Substrate material to be free of organics (roots, logs, twigs, etc.).
7. If practicable, excavated streambed material shall be set aside to be utilized for placement in the culvert. Particular attention should be paid to salvaging the natural streambed surface material to be used for the upper layer in the culvert.

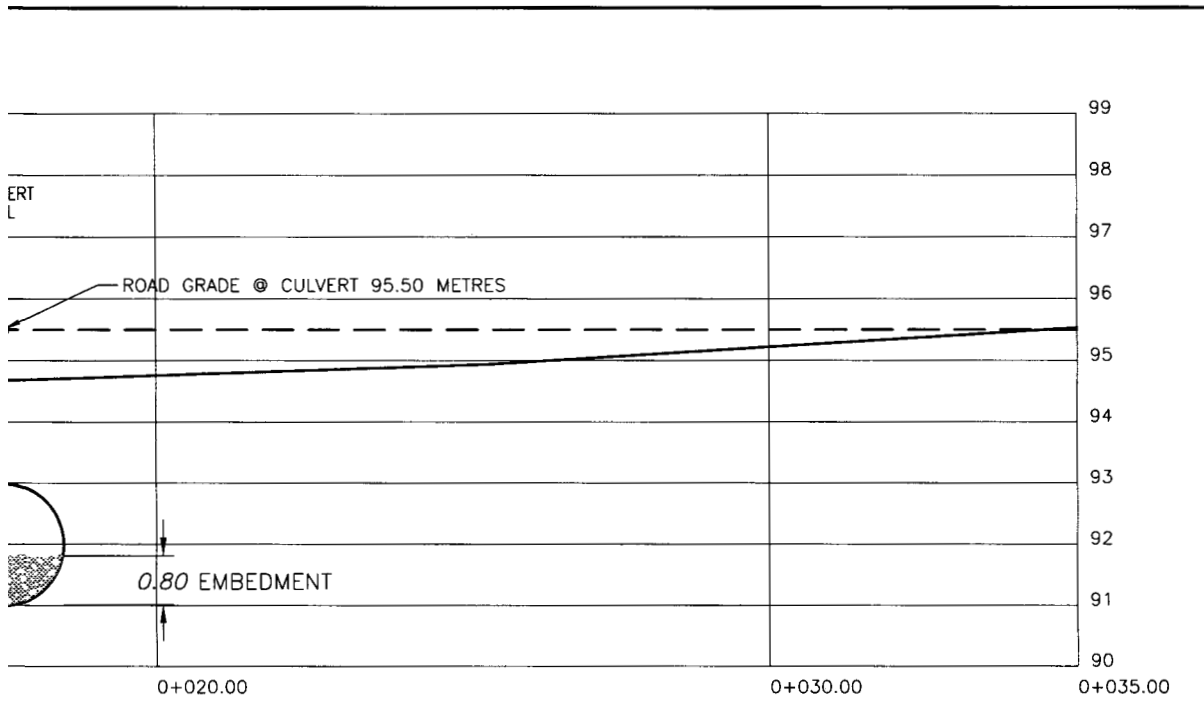

PROFILE

VERT C/L)
VERT 1:100

SCALE BAR

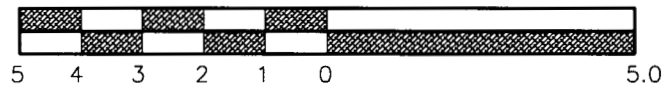

SCALE: AS NOTED (Metric)		PROJECT No.	STRUC. No.
PROPOSED ROAD CROSS SECTIONS PROFILE			
			Survey:
			Design:
			Drawing:
0	FOR CONSTRUCTION		DWG No.
REV.	DESCRIPTION	BY	APPD DATE

SHEET 3 OF 5

Appendix 4. (continued)

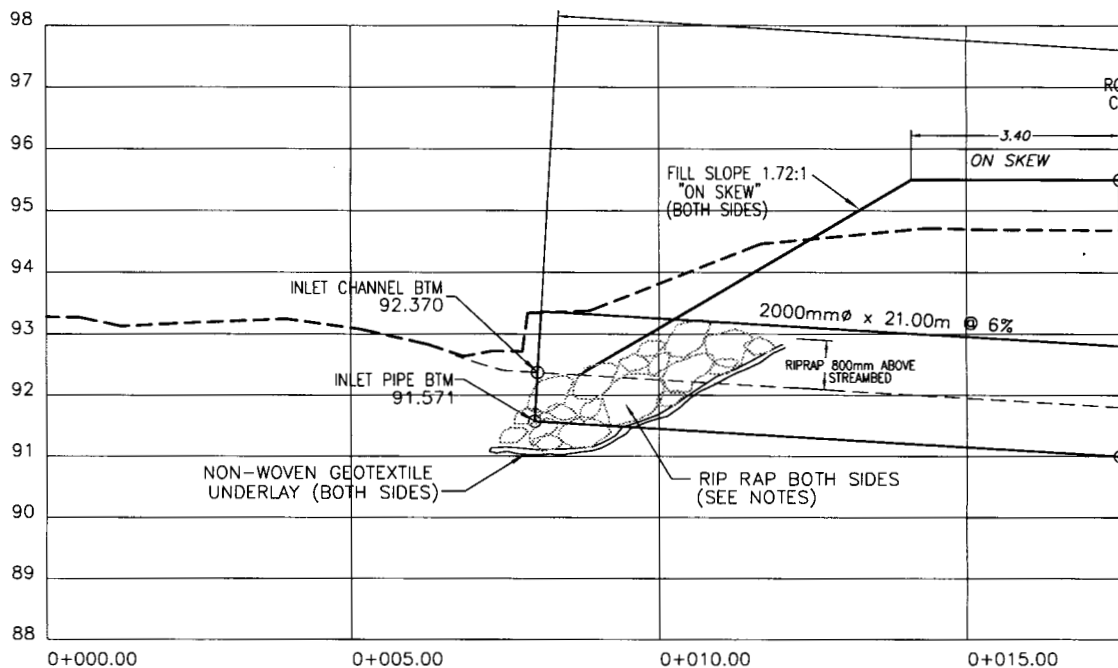

CULVERT
 (61'00" SKEW)
 SCALE HOR 1:10

RIPRAP SPECIFICATIONS

CLASS OF RIPRAP (Kg)	NOMINAL THICKNESS OF RIPRAP (mm)	ROCK GRADUATION: PERCENTAGE LARGER THAN GIVEN ROCK DIAMETER (mm) RIPRAP		
		85%	50%	15%
200	900	260	620	840

NOTES

1. Riprap shall be placed to the extent, depths and thickness noted on the drawings.
2. Riprap to be underlain with non-woven geotextile underlay.
3. Riprap to be clean (free of fines), solid, angular, blocky stones; well graded to fill gaps between larger stones, and placed carefully to obtain well graded blanket of interlocking stones.
4. Minimum riprap layer thickness is 900mm.

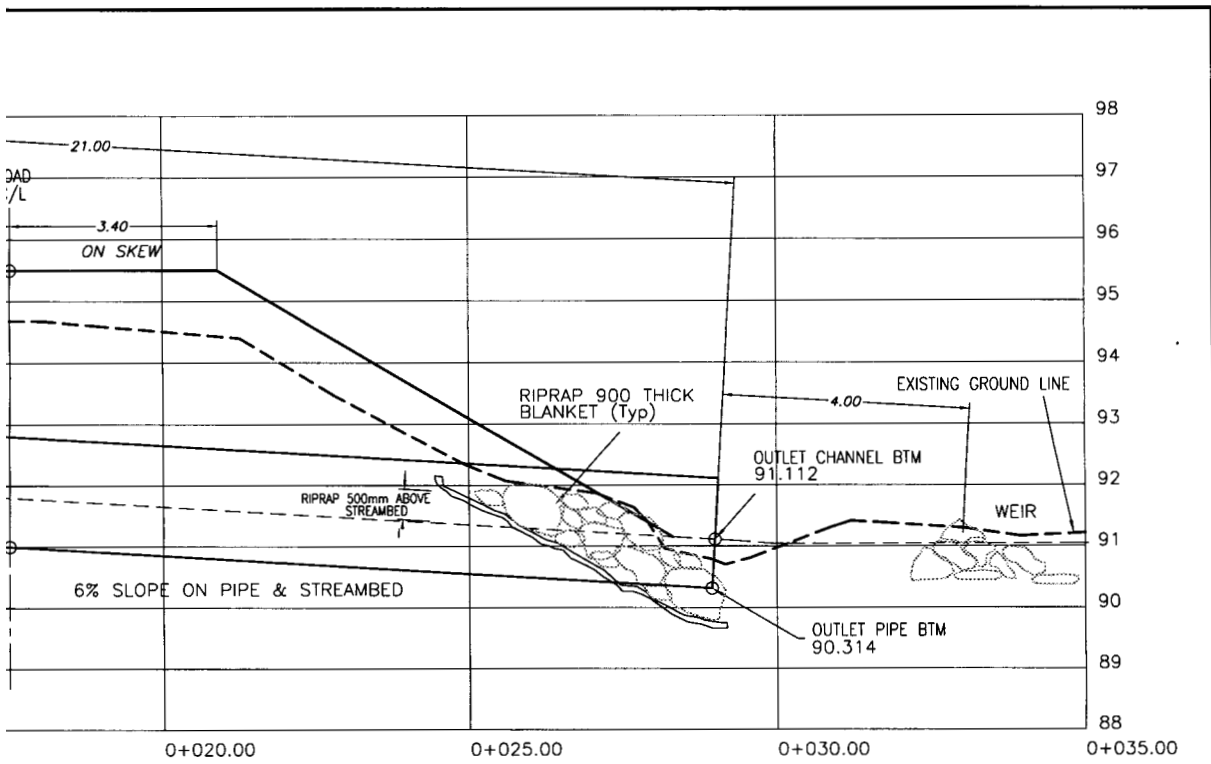

PROFILE

TO ROAD C/L)
 30 VERT 1:100

SCALE BAR

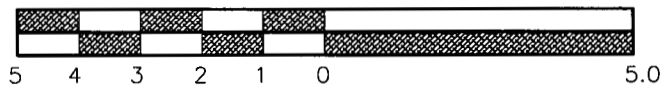

SCALE: AS NOTED (Metric)		PROJECT No.	STRUC. No.
CULVERT CENTRELINE PROFILE			
			Survey:
			Design:
			Drawing:
0	FOR CONSTRUCTION		DWG No.
REV.	DESCRIPTION	BY	APPD DATE

Appendix 4. (concluded)

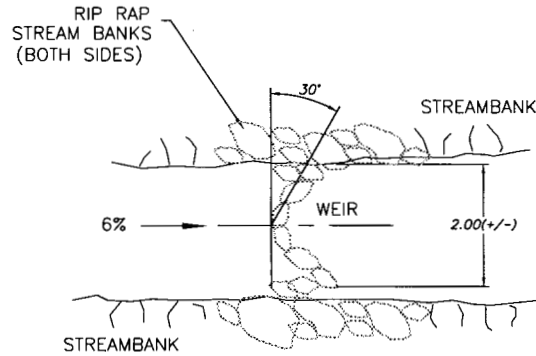

WEIR PLAN

SCALE 1:100

Note:

This drawing is an example of a weir that is an inherent part of the design. Where other measures are to be incorporated (such as trash racks or stream channel bank riprap), the design should provide drawings and specifications for materials and installation.

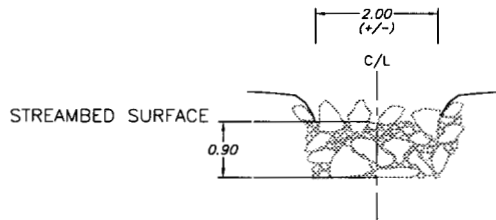

WEIR SECTION B-B

SCALE HOR 1:100 VERT 1:100

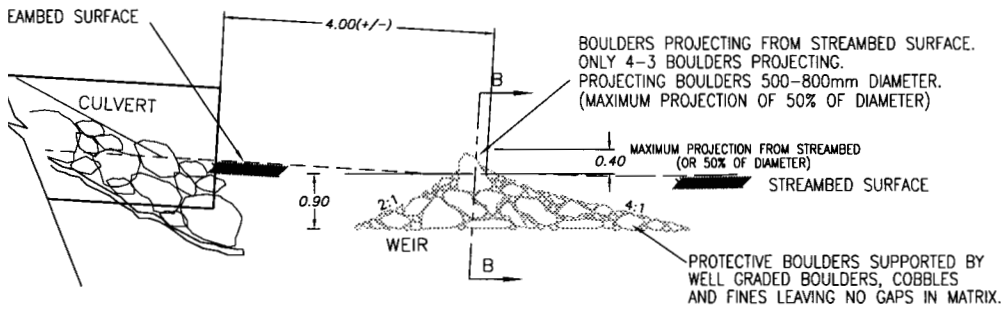

WEIR PROFILE

SCALE HOR 1:100 VERT 1:100

SCALE BAR

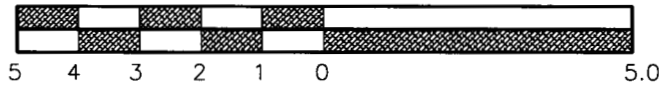

SCALE: AS NOTED (Metric)		PROJECT No.	STRUC. No.
WEIR DETAILS			
		Survey:	
		Design:	
		Drawing:	
0 FOR CONSTRUCTION		DWG No.	
REV.	DESCRIPTION	BY	APPD DATE

SHEET 5 OF 5

Glossary

- Alevin The *Collegiate Dictionary* defines “alevin” as young fish with the external yolk sac still attached.
- Fish The federal *Fisheries Act* defines “fish” as all fish, shellfish, crustaceans and marine animals, and the eggs, spawn, spat and juveniles of fish, shellfish, crustaceans and marine animals.
- Fish habitat The federal *Fisheries Act* defines “fish habitat” as the spawning grounds, nursery, rearing, food supply and migration areas on which fish depend directly or indirectly in order to carry out their life processes.
- Fish stream The *Fish-stream Identification Guidebook* defines “fish stream” as a stream that
- a. is frequented by any of the following species:
 - (i) anadromous salmonids;
 - (ii) rainbow trout, cutthroat trout, brown trout, bull trout, Dolly Varden char, lake trout, brook trout, kokanee, largemouth bass, smallmouth bass, mountain whitefish, lake whitefish, arctic grayline, turbot, white sturgeon, black crappie, yellow perch, walleye or northern pike;
 - (iii) identified threatened or endangered fish classified under Section 71 (of the Operational Planning Regulation);
 - (iv) regionally important fish classified under Section 71, or
 - b. has a slope gradient, determined in accordance with the Ministry of Forests publication *Fish-stream Identification Guidebook*, as amended from time to time, of less than 20%.
 - (i) Unless the stream has been identified in a fish inventory carried out in accordance with the Ministry of Forests publication *Fish-stream Identification Guidebook*, as amended from time to time, as not containing any of the species of fish specified in paragraph (a), or
 - (ii) Unless
 - (A) The stream is located upstream of a known barrier to fish passage identified on a fish and fish habitat inventory map,
 - (B) All reaches upstream of the barrier are simultaneously dry at any time of the year, and
 - (C) No perennial fish habitats exist upstream of the barrier.
- Reach The *Fish-stream Identification Guidebook* defines a “reach” as a watercourse that has a continuous channel bed that meets one of the following requirements:
- a. the channel bed is at least 100 m in length, measured from any of the following locations to the next of any of the following locations:
 - (i) the location where the watercourse begins or ceases to have a continuous channel bed;
 - (ii) the location where
 - (A) a significant change in morphology occurs; for example, at the junction of a major tributary, and
 - (B) the mean width of the channel bed, as measured over a represen-

tative 100 m length of channel bed, upstream and downstream of the morphological change, is sufficient to change the riparian class of the watercourse, if the watercourse were a stream;

- (iii) the location where
 - (A) a significant change in morphology occurs; for example, at the junction of a major tributary, and
 - (B) the mean gradient of the channel bed, as measured over a representative 100 m length of channel bed upstream and downstream of the morphological change, changes from less than 20% to 20% or more, or vice versa;
- b. the channel bed is at least 100 m in length, made up of one or more segments, the boundaries of which are any of the locations referred to in paragraph (a).
- c. the channel bed is less than 100 m in length, if the continuous channel bed
 - (i) is known to contain fish,
 - (ii) flows directly into a fish stream or a lake that is known to contain fish, or
 - (iii) flows directly into a domestic water intake.

Stream

The Forest Practices Code defines a “stream” as a reach flowing on a perennial or seasonal basis, and having a continuous channel bed. It doesn’t matter whether the bed or banks of the reach are locally obscured by overhanging or bridging vegetation or soil mats, as long as the channel bed:

- 1) is scoured by water, or
- 2) contains observable deposits of mineral alluvium.

The primary feature for determining whether a watercourse is a stream under the Code is the presence of a continuous channel bed. If a continuous channel bed exists, then either one of two other key features should be present demonstrating fluvial processes. Flowing water should have:

- 1) scoured the channel bed, or
- 2) deposited any amount of mineral alluvium within the channel.

Water flow in the channel may be perennial, ephemeral (seasonal), or intermittent (spatially discontinuous).

Stream channel width

The *Fish-stream Identification Guidebook* defines “stream channel width” as the horizontal distance between the streambanks on opposite sides of the stream, measured at right angles to the general orientation of the banks. The point on each bank from which width is measured is usually indicated by an observable change in vegetation and sediment texture. This border is sometimes shown by the edges of rooted terrestrial vegetation. Above this border, the soils and terrestrial plants appear undisturbed by recent stream erosion. Below this border, the banks typically show signs of both scouring and sediment deposition.

References and Recommended Additional Reading

Information and guidelines from many sources were incorporated in the development of this guidebook. See the following references for more information on assessment procedures, hydraulic design, and best management practices.

Site Assessment Techniques/Stream Hydrology

Hicks, D.M. and P.D. Mason. 1991. Roughness characteristics of New Zealand rivers. NIWA-Environmental Data. Box 8602, Christchurch, N.Z.

Jarrett, R.D. 1984. Hydraulics of high gradient streams. *Jour. Hyd. Engin.* 110(11):1519–1539.

Newbury, R.W. and M.N. Gaboury. 1993. Stream analysis and fish habitat design: a field manual. Newbury Hydraulics Ltd., Gibsons, B.C.

Erosion and Sediment Control

Goldman, S.J., K. Jackson, and T.A. Bursztynsky. 1986. Erosion and sediment control handbook. McGraw-Hill, Inc. New York, N.Y.

Fish Passage Guidance and Design Criteria

American Iron and Steel Institute. 1994. Handbook of steel drainage and highway construction products. 5th ed. American Iron and Steel Institute. Washington, D.C.

Bates, K. 1992. Fishway design guidelines for Pacific salmon. Washington Dep. Fish and Wildl., Olympia, Wash.

Dane, B.G. 1978. Culvert guidelines: recommendations for the design and installation of culverts in British Columbia to avoid conflict with anadromous fish. Can. Dep. Fish. and Oceans. Fish. Serv. Tech. Rep. No. 811. Vancouver, B.C.

Oregon Department of Fish and Wildlife. 1995. Interim fish passage guidance at road crossings. Memorandum to field dated June 16, 1995, provided by E.G. Roberson, Hydrologist, Oreg. Dep. For. ODF, 2600 State Street, Salem, Oreg.

Stream Simulation for Culvert Installations

Katopodis, C. 1993. Fish passage at culvert highway crossings. Presentation notes, "Highways and the Environment." Can. Dep. Fish. and Oceans. Freshwater Institute, Winnipeg, Man.

McKinnon, G.A. and F.N. Hnyka. 1993. Fish passage assessment of culverts constructed to simulate stream conditions on Laird River tributaries. Can. Dep. Fish. and Oceans. Tech. Rep. No. 1255. Freshwater Institute, Winnipeg, Man.

Robison, E.G. and M. Pyles. 2001. Forest road stream crossing design guide. For. Eng. Dep., Oreg. State Univ., Corvallis, Oreg.

Culvert Studies

Bell, M.C. 1986. Fisheries handbook of engineering requirements and biological criteria. U.S. Army Corps of Engineers. North Pacific Division, Portland, Oreg.

Fitch, G.M. 1997. Designing highway culverts that do not impede the movements of resident fish species. Road Eng. J. Nov. 1, 1997.

Road Location and Layout

Furniss, M.J., S.A. Flanagan, J. Ory, K. Moore, and T.S. Ledwith. 1999. Watershed-scale road stream crossing risk assessment. USDA For. Serv. Six Rivers National Forest, McKinleyville, Calif.
Website: http://watershed.org/WMChome/new/sum_96/risk.html.

Holmes, D.C. 1989. Manual for roads and transportation. Vol. II, revised ed. B.C. Inst. Technol., Burnaby, B.C.

Bioengineering

Polster, D.F. 1997. Bioengineering for water management and slope stability. *In* Road construction strategies under the Forest Practices Code. Paper delivered at an Insight Conference, June 18–19, 1997, Toronto, Ont.

Road Construction, Maintenance, Deactivation

Hynson J. et al. 1982. Handbook for protection of fish and wildlife from construction of farm and forest roads. Eastern Energy and Land Use Team, USDI Fish and Wildl. Serv., Kearneysville, W. Va.

Ketcheson, G.L. and W.F. Megahan. 1996. Sediment production and down-slope sediment transport from forest roads in granitic watersheds. USDA For. Serv. Res. Pap. Intermountain Res. Sta., Ogden, Utah.

Levinski, C.L. 1982. Best management practices for road activities. Vol. I & II. Mimeo, Idaho Dep. of Health and Welfare, Boise, Idaho.

Rothwell, R.L. 1974. Erosion control on forest roads. *In* Environmental considerations of road construction. A short course presented at the Forest Technology School in Hinton, Alta.

———. 1978. Watershed management guidelines for logging and road construction. Can. For. Serv. Western For. Res. Cent., Edmonton, Alta.

Fish Habitat Protection/Identification

Brownlee, M.J. and D.A.A. Toews. 1981. A handbook for fish habitat protection on forest lands in British Columbia. Dep. Fish. and Oceans, Vancouver, B.C.

Clarke, C. (editor) 1997. Mechanical Shock Sensitivity in Salmonid Eggs. Fisheries and Oceans Canada, Pacific Biological Station. Aquaculture Update No. 78. Nanaimo, B.C.

Forest Practices Board. 1998. Forest planning and practices in coastal areas with streams. Tech. Rep., Victoria, B.C.

Guidelines to protect fish and fish habitat from treated wood used in aquatic environments in the Pacific Region. Can. Tech. Rep. Fish. Aquat. Sci. 2314.

Wilford, D. 1998. A strategy for forest management and restoration on alluvial fans in the Prince Rupert Forest Region. B.C. Min. For., Smithers, B.C.

Wright, D.G. and G.E. Hopky. 1998. Guidelines for the use of explosives in or near Canadian fisheries waters. Can. Tech. Rep. Fish. Aquat. Sci. 2107.

Referenced Forest Practices Code Guidebooks

1995. Forest road engineering guidebook. Forest Practices Code. Victoria, B.C.

1995. Riparian management area guidebook. Forest Practices Code. Victoria, B.C.

1998. Fish-stream identification guidebook. 2nd ed. Forest Practices Code. Victoria, B.C.

Fish Species Migratory Timing

Hart, J.L. 1973. Pacific fishes of Canada. Fish. Resear. Board of Canada, Ottawa, Ont. Bull. 180.

McPhail, J.D. and C.C. Lindsey. 1970. Freshwater fishes of northwestern Canada and Alaska. Fish. Resear. Board of Canada, Ottawa, Ont.

Scott, W.B. and E.J. Crossman. 1973. Freshwater fishes of Canada. Fish. Resear. Board of Canada, Ottawa, Ont. Bull. 184.