

## TABLE OF CONTENTS

### VOLUME 1

<b>EXECUTIVE SUMMARY.....</b>	<b>1</b>
Background and Purpose .....	1
Overview of Previous Work .....	1
Other Relevant Fixed Links & Tunnels Worldwide .....	1
The Environment and Geology of the Study Area .....	1
Assessment of Alternative Fixed Link Concepts .....	2
<i>Bridge.....</i>	<i>2</i>
<i>Causeway.....</i>	<i>2</i>
<i>Tunnels.....</i>	<i>2</i>
<i>Comparison Summary of Alternatives.....</i>	<i>3</i>
Implementation Schedule .....	4
Regulatory and Environmental Issues .....	4
Economic and Business Case Analysis .....	4
Financing Considerations .....	7
Conclusions .....	7
<b>1 INTRODUCTION.....</b>	<b>8</b>
1.1 Background and Purpose.....	8
1.2 Overview of Previous Work.....	9
1.3 Study Approach.....	10
<b>2 REVIEW OF RELEVANT FIXED LINKS WORLDWIDE.....</b>	<b>12</b>
2.1 Øresund Link.....	12
2.2 Storebælt Crossing.....	13
2.3 Channel Tunnel.....	13
2.4 Lantau Link.....	14
2.5 Chesapeake Bay Bridge-Tunnel.....	15
2.6 Confederation Bridge.....	16
2.7 Summary of Fixed Links.....	16
2.8 Other Relevant Tunnels.....	17
<b>3 THE PHYSICAL ENVIRONMENT OF THE STUDY AREA AND DESIGN CRITERIA/CONSIDERATIONS.....</b>	<b>18</b>
3.1 Climate.....	18
<i>Air Temperature.....</i>	<i>18</i>
<i>Precipitation.....</i>	<i>18</i>
<i>Winds.....</i>	<i>18</i>
<i>Degree Days.....</i>	<i>18</i>
<i>Icing.....</i>	<i>18</i>
3.2 Oceanography.....	19
<i>Bathymetry.....</i>	<i>19</i>
<i>Currents.....</i>	<i>20</i>
<i>Waves.....</i>	<i>20</i>
3.3 Sea Ice.....	20

3.4	<b>Icebergs</b> .....	<b>21</b>
3.5	<b>Geology</b> .....	<b>23</b>
	<i>Bedrock Geology</i> .....	23
	<i>Surficial Geology</i> .....	27
	<i>Geological Faulting and Water Ingress Considerations</i> .....	28
3.6	<b>Design Criteria and Considerations</b> .....	<b>29</b>
	<i>Environmental Design Criteria</i> .....	29
3.7	<b>Capacity and Dimensional Requirements for the Fixed Link</b> ...	<b>30</b>
	<i>Traffic volumes and mode of transit</i> .....	30
	<i>Road Tunnel</i> .....	32
	<i>Rail Tunnel</i> .....	35
	<i>HVDC Cabling Requirements</i> .....	36
<b>4</b>	<b>ASSESSMENT OF ALTERNATIVE FIXED LINK CONCEPTS</b> .....	<b>39</b>
4.1	<b>Bridge</b> .....	<b>39</b>
4.2	<b>Causeway</b> .....	<b>41</b>
4.3	<b>Tunnels</b> .....	<b>44</b>
	<i>4.3.1 Bored Tunnel</i> .....	44
	<i>4.3.2 Drill and Blast</i> .....	56
	<i>4.3.3 Immersed Tube Tunnel (ITT)</i> .....	62
4.4	<b>Comparison of Alternatives</b> .....	<b>71</b>
	<i>Risk Assessment</i> .....	71
	<i>Comparison Summary</i> .....	73
<b>5</b>	<b>DEVELOPMENT OF THE PREFERRED ALTERNATIVE</b> .....	<b>75</b>
5.1	<b>Schedule</b> .....	<b>75</b>
5.2	<b>Cost Comparison</b> .....	<b>76</b>
<b>6</b>	<b>REGULATORY AND ENVIRONMENTAL ISSUES</b> .....	<b>77</b>
6.1	<b>List of Applicable Legislation, Standards, and Permits</b> .....	<b>78</b>
<b>7</b>	<b>ECONOMIC AND BUSINESS CASE ANALYSIS</b> .....	<b>81</b>
7.1	<b>Transportation Demand</b> .....	<b>81</b>
	<i>7.1.1 Markets Served</i> .....	81
	<i>7.1.2 Primary Target Markets</i> .....	83
	<i>7.1.3 Traffic Projections - Fixed Link</i> .....	91
	<i>7.1.4 Traffic Projections - Upgraded Ferry</i> .....	100
7.2	<b>Tolls and Revenue Forecasts</b> .....	<b>104</b>
7.3	<b>Economic Evaluation</b> .....	<b>106</b>
	<i>7.3.1 Internal Revenues and Costs</i> .....	106
	<i>7.3.2 Present Value Analysis for Base Case</i> .....	108
	<i>7.3.3 Present Value Analysis for the Upgraded Ferry</i> .....	110
	<i>7.3.4 Results of Economic Analyses</i> .....	112
<b>8</b>	<b>FINANCING CONSIDERATIONS &amp; FINANCIAL ANALYSIS</b> .....	<b>119</b>
8.1	<b>Financing Considerations</b> .....	<b>119</b>
	<i>Public Infrastructure Financing Alternatives</i> .....	119
	<i>Private Finance and Risk Transference</i> .....	122
	<i>Capital Markets - Expectations</i> .....	123
8.2	<b>Financial Analysis</b> .....	<b>124</b>
	<i>Selection of Key Target Parameters</i> .....	124

*Financial Analysis Results*.....124

**9 CONCLUSIONS**..... **127**

9.1 Study Findings..... 127

9.2 Future Required Activities..... 128

**VOLUME 2**

**APPENDICES**

APPENDIX A Study Phase 1 – List of References

APPENDIX B C-CORE Iceberg Scour Risk Report

APPENDIX C Detailed Report on ITT Option

APPENDIX D Detailed Breakdown of Cost Estimates

APPENDIX E Breakdown of Highway Tunnel Operating / Maintenance Costs

APPENDIX F Breakdown of Railway Tunnel Operating / Maintenance Costs

APPENDIX G Economic Analysis Workbooks

This report has been prepared by Hatch Mott MacDonald (HMM), who have worked independently under contract to the Leslie Harris Centre of Regional Policy and Development, “the Harris Centre”, formerly the “Public Policy Research Centre”. The material within this report is intended for use by the Harris Centre, the Government of Newfoundland and Labrador and the Government of Canada. The distribution of the report will be as determined by the Government of Newfoundland and Labrador and the Government of Canada. It reflects the information available and the judgement of HMM and its subconsultants. Acceptance of this report by the Harris Centre or by the Province or the Federal Government is for contractual purposes only, and should not be construed as acceptance of the opinions and conclusions contained therein. Any use, which a third part makes of this report, or any reliance on decisions to be based on it, is the responsibility of such party.

## EXECUTIVE SUMMARY

### Background and Purpose

The concept of providing a fixed transportation link between the Island of Newfoundland and Labrador across the Strait of Belle Isle has been the subject of discussion for many years. In early 2004, the Public Policy Research Centre of Memorial University, acting on behalf of the Government of Newfoundland and Labrador requested a proposal from independent consultants to conduct a study of fixed link concepts at a pre-feasibility level. In April, 2004, the Policy Centre awarded a contract for the study to Hatch Mott MacDonald.

In keeping with the Terms of Reference, the study was undertaken in four distinct phases as follows:

- ♦ Phase 1 – Background and Research.
- ♦ Phase 2 – Engineering and Technical Feasibility Options Analysis.
- ♦ Phase 3 - Economic and Business Case Analysis.
- ♦ Phase 4 - Financing Considerations.

### Overview of Previous Work

The most relevant work in the study area is that carried out over a 10-year period in the 1970's and early 1980's by the Lower Churchill Development Corporation (LCDC). This comprehensive program of site investigations and engineering studies related to the crossing of the Strait, for the purposes of electricity transmission, by means of a tunnel constructed in the deep Precambrian granite underneath the Strait. The tunnel was to be created using drill-and-blast methods and, by being in this zone, potential problems with water ingress and fragmented rock in the upper sedimentary layers would be avoided. By late 1979, however, as more sophisticated studies of the risk associated with iceberg scour problems were conducted, it was concluded that a trenched submarine cable crossing route could be selected. Information obtained from approximately 40 reports on various aspects of the crossing, made available to the study by Newfoundland and Labrador Hydro, formed the basis of the study background.

### Other Relevant Fixed Links & Tunnels Worldwide

In order to obtain an appreciation of the parameters relating to major fixed links and to make a comparison with the subject fixed link, a review was conducted of eight tunnels, causeways and bridges. The review showed that the costs varied from \$10 million per kilometre for the Laerdal Tunnel in Norway to \$700 million per kilometre for the Channel Tunnel, illustrating that the location and characteristics of the project can have a dramatic effect on the cost of the facility.

### The Environment and Geology of the Study Area

The Strait of Belle Isle, generally speaking, is an inhospitable area in which to carry out major surface-related construction because of its unpredictable weather, high currents, sea ice and icebergs. The depth of the Strait varies significantly over its length with the area of the shortest crossing containing water as deep as 100m.

The geology of the Strait in the vicinity of the shortest crossing consists of a sedimentary layer of sandstones and limestone that is overlain by soil of various depth and constituency. Underlying this layer of rock is an approximately 500 metre thick layer of Precambrian granitic gneiss that varies from 130 metres below the ground surface on the Labrador side to 475 metres below on the Newfoundland side. An item of some concern is the potential for water ingress through the less competent sedimentary layer.

### Assessment of Alternative Fixed Link Concepts

Three basic fixed link concepts were studied: bridge, causeway with bridges, and tunnel. In the case of a tunnel, the options were further divided into bored, drill and blast, and immersed tube (ITT). Both road and rail modes were considered for the tunnel option. Initial capacity assessment indicated that the projected traffic could be accommodated with excess capacity by a two lane above ground facility or with appropriate capacity by a single lane tunnel operated periodically in each direction by road vehicles or by roll-on/roll-off shuttle trains

For each of these concepts, the route across the Strait was taken as that between Pointe Amour and Yankee Point, which is the shortest distance, at 18 kilometres.

#### *Bridge*

A bridge crossing of the Strait would present very large risks, including design, construction and operation issues relating to the iceberg zone, and deep water depths and difficult weather conditions. Because of the water depths in the Strait and the need to minimize the exposure of structures to iceberg loadings, it is clear that the largest possible spans and, hence, suspension bridges of 2 kilometre spans would be used. A clearance of at least 50 metres is needed between the bridge deck and sea level to accommodate vessels and icebergs. All of the bridge piers would have to be protected by berms in order to withstand impact forces from icebergs.

#### *Causeway*

A causeway across the Strait of Belle Isle would be an ambitious undertaking, although with possibly lower risk than for a full bridge concept. While a causeway would still need one or more bridges, it could cope more easily with ice and icebergs and the bridge piers could be integrated into the causeway for protection. Foundations and anchoring for the bridges would still be very challenging; however, the number of foundations would be less. An obvious major environmental risk is the possible effects that such a structure could have on marine life and on the current regime in the area. For the purposes of this study, it has been assumed that two openings, spanned by bridges, would be needed in the causeway and that these would be located at the position of the shipping lanes.

#### *Tunnels*

Most of the risk factors associated with a surface crossing of the Strait of Belle Isle are eliminated with a tunnel that is constructed below the seabed. For an ITT, the risk of iceberg impact still exists. An immersed tube tunnel would consist of a series of connected and sealed pre-fabricated tunnel units within a pre-dredged trench in the seabed. The tunnel units are floated to their required location and sunk to their final position. The tunnel elements would have to be protected either by being buried below the depth of iceberg scour or by having sufficient protection to absorb the energy of an iceberg.

One of the primary risks associated with drill-and-blast or bored tunnels relates to the potential for water ingress through faulted and fragmented rock. For the electrical transmission cable tunnel, planned in the 1970's, the concern relating to water ingress caused the selection of a deep alignment at 400-500 metres below sea level. This placed the tunnel in the Precambrian gneiss layers that were considered to be significantly less permeable than the sedimentary rock layers above. For a transportation tunnel, such a deep alignment is not an option since with typical transportation downgrades and upgrades, the length of tunnel dictated would be prohibitively expensive. Fortunately, developments in tunnel excavation techniques in recent years have made possible a shallower tunnel within the sedimentary layer.

Two excavation techniques are available; these are drill-and-blast excavation and bored tunnels utilizing a tunnel boring machine. For the drill-and-blast excavation, water ingress must be reduced by grouting ahead of the tunnel face to seal water paths. This is not absolutely reliable in preventing water ingress and therefore a separation from the seabed of approximately 60 metres was selected for this analysis. For the bored tunnel option, the tunnel lining is installed immediately as the tunnel is progressed, water ingress is prevented and a higher alignment is possible. A bored tunnel would be constructed by a pressurized face tunnel boring machine (TBM). This type of TBM is designed to apply pressure to the excavation face to support the ground and to counteract water pressure in fractures and fissures. For this study, the highest practicable alignment, with about 10 metres of rock cover was selected. Because a drill & blast tunnel would be located further down in the sedimentary layer, the road and rail options are 0.3 kilometre and 4.4 kilometres longer than the respective tunnels constructed using TBM.

### *Comparison Summary of Alternatives*

Table 1 provides a comparative summary of all alternatives based on the road and rail options.

**Table 1 - Summary Comparison of Options for the Fixed Link**

<b>Option</b>	<b>Construction Cost (\$millions 2004 dollars)</b>	<b>Annual Operating Cost (\$millions 2004 dollars)</b>	<b>Risk Level</b>	<b>Preliminary Schedule (years)</b>
<b>Road Options</b>				
TBM Bored Tunnel	1,559	6.8	Moderate	12.2
Drill & Blast Tunnel	1,800	6.8	High	17.8
Immersed Tube Tunnel	4,810	6.8	High	14.7
Bridge	4,227	16.9	Extreme	15
Bridge / Causeway	10,123	4.3	High	18
<b>Rail Options</b>				
TBM Bored Tunnel	1,184	7.64	Moderate	10.7
Drill & Blast Tunnel	2,272	7.64	High	23.8
Immersed Tube Tunnel	3,814	7.64	High	15

The table illustrates that a TBM bored tunnel would have the lowest cost and risk, and a rail option would be less costly than a road option. A shuttle train in a TBM bored tunnel is therefore the preferred concept. The total development cost, including interest during construction and escalation, for the preferred concept would be approximately \$1.7 billion.

### Implementation Schedule

In all cases, three years were allowed for additional studies, field investigations, environmental assessment and other planning activities, and two years were allowed for detailed design for a total of 5 years prior to start of construction.

Using two TBM's, one from each side of the Strait and a seven-day work week provides the shortest construction and commissioning period for the rail tunnel of 5.7 years for a total project implementation time of 10.7 years.

### Regulatory and Environmental Issues

Of the concepts addressed, a tunnel will have the least effect on the environment, in particular the physical environment of the Strait. The potential large scale oceanographic and climatic effects that might be wrought by a surface crossing such as a causeway and bridge would be avoided. In the Strait itself, there would be very little or no effect from the actual tunnelling process or from the traffic once the tunnel is completed.

The principal concern with respect to the tunnel itself is likely to be the disposal of the excavated material. Overall, while the project would be a major undertaking over a long construction period, its nature is such that there would not likely be major environmental concerns that are outside the realm of a typical heavy construction and earth moving project.

A complete assessment of the environmental implications and requirements would be required to be undertaken at a later stage of the project.

### Economic and Business Case Analysis

Three scenarios for addressing the crossing have been analysed. These are as follows:

- a) The Base Case – a bored, 2 TBM, tunnel with a railway shuttle;
- b) An Upgraded Ferry Link
- c) The Base Case augmented by income from an installed HVDC transmission line

The period for planning, design and construction of the facility is 11 years and the operating period examined is 30 years, for a total economic life cycle of 41 years.

Transportation demand projections were developed based on an understanding of the existing markets served. Future potential demand for a fixed link can come from; new developments to attract tourism and induced demand; new economic developments to attract long term commercial vehicle traffic and; major projects that can generate elevated demand for defined periods.

New growth in tourism could result from creation of new national and provincial parks, expansion of tourism infrastructure including accommodations and dining facilities, and successful major advertising campaigns. The Maritimes and Ontario are the largest sources of tourism. Tourism in Newfoundland and Labrador is

growing at an increasing rate. The projection, therefore, with or without a fixed link will be to sustain recent trends of 3.5% growth.

Figure 1 shows comparative driving distances and times between Quebec City and St. John's and using the existing Trans-Canada Highway through the Maritimes, using the Trans-Labrador Highway (when completed) to a new fixed link, and using a new Quebec north shore highway (when completed) to a new fixed link. It can be seen that driving distances for travellers using a fixed link would be similar to those on the Trans-Canada Highway.

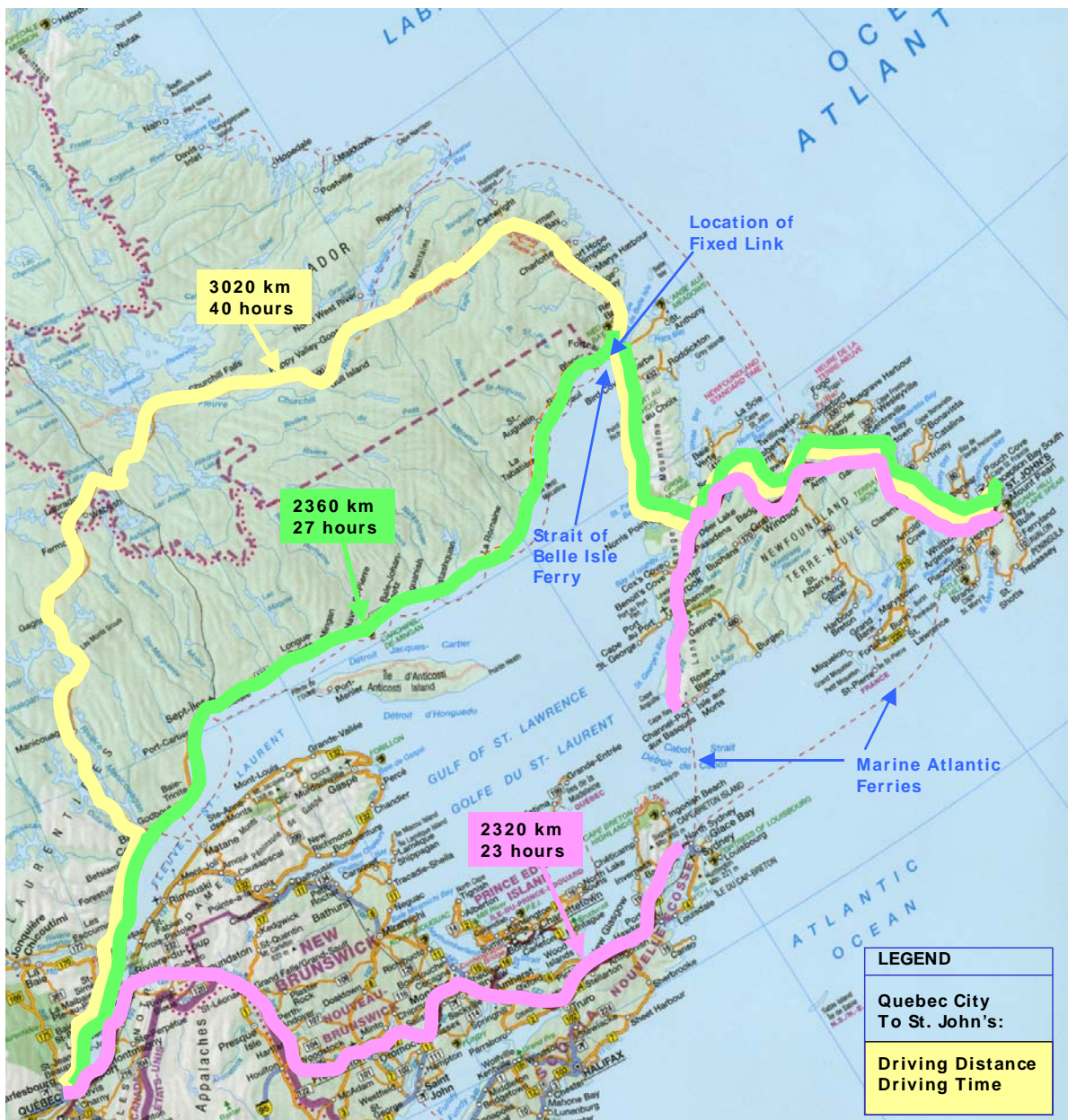

Figure 1 - Travel Distances



In determining traffic projection for a fixed link, three types of changes were evaluated.

- One time surge in demand of 30%, primarily affecting local and business traffic;
- One time diversion from Marine Atlantic of 13 % to 15 % to a new fixed link;
- Sustained annual growth of 1.5 % to 4.75 % (depending on type of travellers).

Somewhat more modest increases in traffic were projected for an upgraded ferry.

Revenues for a fixed link and for the upgraded ferry were calculated on the basis of existing *Apollo* tolls. For the augmenting that results from the inclusion of a HVDC cable, the avoided costs were established from costs for a submarine cable, supplied by Newfoundland and Labrador Hydro.

A profile of operations and maintenance costs was developed for the analysis cases. Combining these O & M costs with projected revenues and invoking a discount rate of 7.5 percent (10 percent nominal less 2.5 percent inflation) results in the operating cash flow.

The economic evaluation results are shown in Table 2. Net Present Values (NPV), Internal Rates of Return (IRR) and Benefit Cost Ratios (BCR) are calculated where they are applicable for the cases studied.

**Table 2 Economic Evaluation Results**

LEVEL	CASE	NPV	IRR	BCR
		\$ millions 2004	%	#
Internal Returns	BASE CASE	- 648	- 9.5%	0.07
	HVDC	- 554	-2.1%	0.25
	FERRY UPGRADE	- 164	N/A	0.13
Internal Returns & Economic Returns	BASE CASE	- 559	-5.2%	0.20
	HVDC	- 466	-1.0%	0.37
	FERRY UPGRADE	- 116	N/A	0.38
Internal Returns & Economic Returns & Social Returns	BASE CASE	- 333	-1.3%	0.53
	HVDC	- 240	1.6%	0.68
	FERRY UPGRADE	- 114	N/A	0.39

Sensitivity analyses were undertaken and showed low sensitivity to variations in traffic, high sensitivity to capital costs, relatively low sensitivity to operation and maintenance costs, and high sensitivities to social discount rate and inflation rate.

## Financing Considerations

Because the business case for a fixed link would be difficult to justify on the basis of the results of the economic analysis, any financing arrangements would require an infusion of public funds. This is not unusual in the case of such infrastructure. Of the various potential financing mechanisms addressed in this study, some form of Public Private Partnership (PPP) was considered to be the most applicable.

## Conclusions

A tunnel bored using modern tunnel boring machines under the Strait of Belle Isle, at its narrowest point, is the most technically and economically attractive alternative.

The construction cost of a bored tunnel would be approximately \$1.2 billion in 2004 dollars. The total development cost for financing purposes, including escalation and interest during construction would be approximately \$1.7 billion. The construction period would be six years and an additional five years would be required for planning, additional studies and investigations and environmental assessments, for an overall development period of 11 years.

Based on traffic projections over a 30-year period, the most economic tunnel arrangement would be an electric train shuttle, operating through a single tunnel with staged operation in each direction, that conveys road vehicles on custom-designed rail cars.

The economic and business case analysis showed that a fixed link could not be financed privately under normal economic and business case criteria. This result, however, may be considered not unusual in the realm of public transportation infrastructure.

Including costs and revenue for the transmission lines has an effect on the overall viability of the fixed link. Incorporating the HVDC cables in the fixed link rather than constructing a submarine installation, reduces the capital cost to an HVDC proponent by approximately \$390 M. This cost reduction includes the cost of the cable, for which a rental would be charged by the fixed link proponent.

Of the financing methodologies addressed, some form of PPP (Public Private Partnership) arrangement would appear to be the most appropriate. An infusion of approximately \$1.4 billion from public sources would be required to make the proposition attractive to the private sector.

## 1 INTRODUCTION

### 1.1 Background and Purpose

The concept of providing a fixed transportation link between the Island of Newfoundland and Labrador (and mainland Canada) across the Strait of Belle Isle has been the subject of discussion for many years. Recently, a renewed interest in the concept has developed as a means of making a direct connection with the national highway system and providing a greater degree of integration between the Island of Newfoundland and Labrador.

In early 2004, the Public Policy Research Centre of Memorial University, acting on behalf of the Government of Newfoundland and Labrador and in keeping with its mandate of studying and aiding in the formulation of social and economic public policy, requested a proposal from independent consultants to conduct a study of fixed link concepts at a pre-feasibility level. The objective of the study was “to undertake an independent examination of the economic and technical implications and viability of constructing a fixed transportation link across the Strait of Belle Isle between Labrador and the Island of Newfoundland.”

In April 2004, the Policy Centre awarded a contract for the study to Hatch Mott MacDonald. The Atlantic Canada Opportunities Agency (ACOA) and the Government of Newfoundland and Labrador provided financial support for the study. The Policy Centre directed the study with advice from a Project Advisory Committee which consisted of Policy Centre representatives as well as representatives from ACOA, Transport Canada, Government of Newfoundland and Labrador, Newfoundland and Labrador Hydro, and an independent technical advisor.

In keeping with the Terms of Reference the study was undertaken in four distinct phases as follows:

**Phase 1 – Background and Research** involving a literature review of previous work in the study area as well as of related projects internationally.

**Phase 2 – Engineering and Technical Feasibility Options Analysis** that entailed the identification and evaluation of alternative fixed link configurations and associated infrastructure, costing, and schedule development. The alternatives to be considered were road and rail tunnels (drill and blast and bored); immersed tube tunnel; bridge and causeway; or various combinations of these alternatives. The relative risks of these alternative concepts were assessed in this feasibility analysis.

**Phase 3 - Economic and Business Case Analysis** requiring economic analysis, business case analysis, and sectoral analysis of the preferred fixed link option from Phase 2. This phase also required additional analysis encompassing considerations of the economic implications of installing a high voltage direct current (HVDC) transmission, and a preliminary identification of the potential environmental implications of a fixed link. This phase further required the analysis of an upgraded ferry as an alternative to a fixed link.

**Phase 4 - Financing** encompassing an assessment of potential public and private sector options to develop and operate the proposed infrastructure and the financing arrangements and implications associated with these options

Figure 1.1 is a map of eastern Canada showing the existing transportation connections as well as a proposed fixed link connection to the Island of Newfoundland. The location of the link on this map is the shortest route across the Strait and follows the proposed route in prior power transmission studies. The primary existing

connection that would be affected by a fixed link is the ferry service across the Strait of Belle Isle, which is currently seasonal. The route of this service, as well as the ferry services from Nova Scotia to the Island of Newfoundland, is also shown.



Figure 1.1 – Location Map

## 1.2 Overview of Previous Work

The most relevant work in the study area is that carried out over a 10-year period in the 1970's and early 1980's by the Lower Churchill Development Corporation (LCDC). This comprehensive program of site investigations and engineering studies related to the crossing of the Strait for the purposes of electricity

transmission from proposed hydroelectric developments on the Lower Churchill River in Labrador. In the early work, the proposed method of carrying the high voltage cables was in a tunnel that would be constructed in the deep Precambrian granite underneath the Strait. At that time, holes were drilled on both the Newfoundland and Labrador sides of the Strait in the locations of proposed tunnel shafts to the depth of this granite layer to obtain geological information. The tunnel was to be created through drill-and-blast methods and by being in this zone; potential problems with water ingress and fragmented rock in the upper sedimentary layers would be avoided. Also, the risk of damage to submarine cables laid on the sea bottom from iceberg scour would obviously be avoided.

By late 1979, however, as more sophisticated studies of the risk associated with iceberg scour problems were conducted and ditching technology became more advanced, it was concluded that a cable crossing route could be selected such that the risk associated with scour of a submarine cable could be reduced to an acceptable level. Additional engineering studies were then conducted for such a cable crossing over a more circuitous route than the straight-line tunnel route from Pointe Amour in Labrador to Yankee Point in Newfoundland.

Throughout the period of these studies, climatic, oceanographic, seismic, and geological/geotechnical data were collected, and detailed engineering assessments, schedules and cost estimates were developed. Some 40 reports were produced. Information obtained from these reports, which were made available to the study by Newfoundland and Labrador Hydro, together with information obtained from other studies done by Newfoundland and Labrador Hydro in the late 1990's and public sources, formed the basis of much of the study background as well as for the development of an understanding of the geology of the Strait and the physical environment of the study area.

### 1.3 Study Approach

The work was conducted generally according to the phases identified above. On completion of each phase, a meeting was held with the Project Advisory Committee to review progress before proceeding to the next phase. The initial step was to review the prior work conducted by LCDC and Newfoundland and Labrador Hydro, as well as other information in the public domain, in order to understand the study environment and the potential problems inherent in any fixed link across the Strait. Concurrently, a review of relevant fixed link concepts worldwide was undertaken, and potential traffic volumes on a fixed link across the Strait were projected in order to broadly size the link capacity and configuration.

All of the potential concepts for a fixed link were assessed in a preliminary manner, and based on knowledge of the most up-to-date technology, design and costing were taken to a level sufficient to determine whether each concept was practicable and technically and economically viable. Information required for the business case and economic analysis of a fixed link was developed from the relevant sectors of the economy through discussions with government officials, transportation company representatives and Statistics Canada and provincial government department data. Using this information and the engineering estimates associated with the preferred concept, the study team then conducted various financial and economic analyses to determine the overall feasibility of the concept. Potential methods of financing the implementation of such a concept were also addressed.

All of the work was then brought together in this report. The report is structured generally according to the phased approach of the study. Following this Introduction, a review of relevant fixed links worldwide is presented in Section 2; the geology, physical environment of the study area and associated design criteria, as well as a preliminary development of fixed link traffic potential as a basis for link capacity sizing, are

addressed in Section 3; the engineering assessment for various link alternatives along with preliminary costing and construction schedules are developed in Section 4; details of the estimate and implementation schedule for the favoured alternative are presented in Section 5; a discussion of the potential regulatory and environmental assessment requirements for the favoured alternative is presented in Section 6; the results of the business case and economic analyses are discussed in Section 7; potential financing approaches are discussed in Section 8; and conclusions are presented in Section 9. Cost estimates and other details are attached as appendices.

## 2 REVIEW OF RELEVANT FIXED LINKS WORLDWIDE

A review was undertaken of fixed links worldwide that were considered to be of relevance to a fixed link across the Strait of Belle Isle. Fixed links crossing ocean channels and straits comparable to this location were selected. Examples were also selected to illustrate the different types of construction methodologies available for the provision of such fixed links. In general terms, the types are: multiple medium span viaducts or rock fill causeways; long span bridges, either cable-stayed or suspension; and tunnels, immersed tube or bored.

### 2.1 Øresund Link

The Øresund Link, that opened in 1999, connects Denmark and Sweden across the Øresund Channel. The crossing accommodates a four lane highway and a twin track rail line. The 22 kilometre channel is crossed by a combination of a 16 kilometre bridge and a 6 kilometre immersed tube tunnel (ITT). The tunnel section provides the primary shipping channel. A secondary shipping channel is accounted for by a long cable-stayed span within the bridge section.

The multi-functional requirement of the tunnel suits the low profile rectangular structure that can be easily provided by an ITT, as shown on Figure 2.1. The requirement for both rail and road resulted in a structure approaching 40metres in width that would have been very difficult to accommodate in a bored tunnel configuration. Further, the shallow channel (about 22 metres deep) lends itself to immersed tube construction within the overburden seabed.

The lesson learned from this crossing was that immersed tube tunnels are very applicable to, and efficient for, shallow channels and where the tunnel configuration requires a low profile rectangular cross-section.

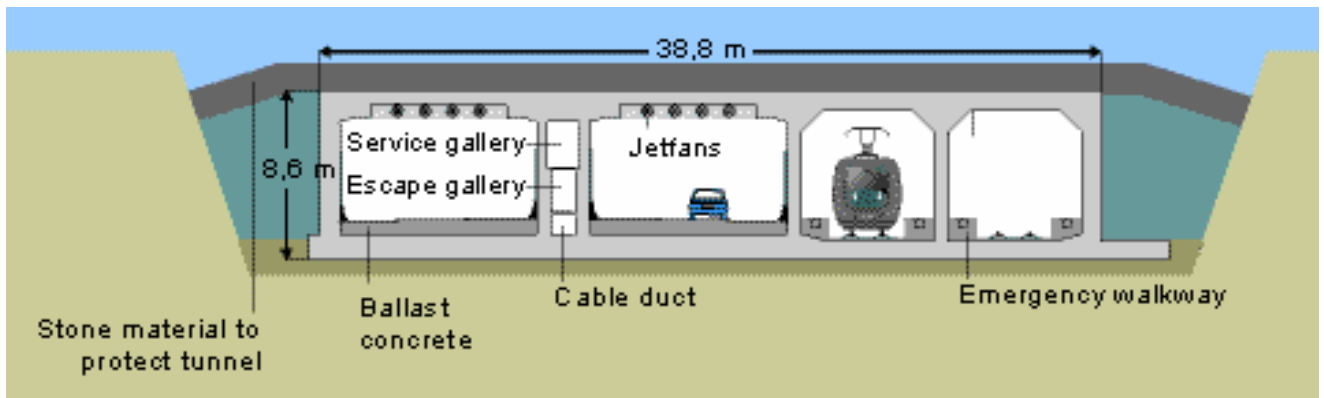
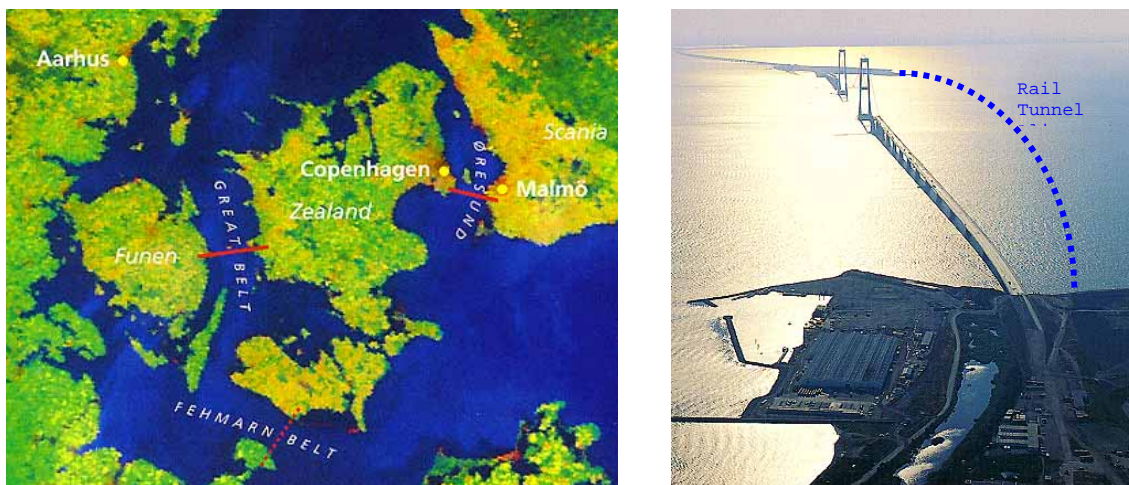

Figure 2.1 - Øresund Link Cross-Section

## 2.2 Storebælt Crossing

The Storebælt Crossing, as shown in Figure 2.2, between the islands of Funen and Zealand in Denmark opened in 1998 and is part of the highway and rail connection between Denmark and Sweden. Like the Øresund Link, the crossing provides a four lane road and a twin track rail line. The total crossing length of 16 kilometres is comprised of a bridge for rail and road from Funen to a small island within the channel, with a bridge for the road plus bored twin tunnels for the rail line across the primary shipping channel between the island and Zealand. The depth of the channel, at about 60 metres, and the tunnel cross-sections suited to bored tunnels, made an immersed tube tunnel not economically competitive. The twin tunnels are approximately 8 kilometres long and were constructed in overburden below the seabed using earth pressure balance tunnel boring machines.

The lesson learned from the tunnel section was that bored tunnels could be built in very challenging ground conditions. The tunnel construction experienced significant difficulties. It represented an early application of earth pressure balance tunnel boring machines and provided many lessons that have contributed to earth pressure balance TBMs now becoming the standard technique for soft ground and soft rock tunnelling.



**Figure 2.2 - Storebælt Crossing**

## 2.3 Channel Tunnel

The Channel Tunnel, as shown in Figure 2.3, was opened in 1994 and is probably the most famous fixed link in the world. The tunnel is actually three 50 kilometre-long parallel tunnels; two running tunnels carrying rail tracks and one service tunnel for maintenance vehicles and for emergency egress. The tunnels were constructed by tunnel boring machines excavating in a layer of chalk marl that extends across the Channel. The tunnels are used by high speed Eurostar trains operating at 160 kilometres per hour through the tunnel as well as by custom-built shuttle trains conveying passenger cars and trucks loaded and unloaded at the terminals.

The lessons learned from the Channel Tunnel are numerous. The following are considered relevant to this study. The chalk marl was predicted to be an almost ideal tunnelling material. It was expected to be virtually impermeable, to be easily excavated and to stand up generally with a minimum of support. These properties eventually allowed very impressive advance rates to be achieved by the TBMs and the tunnels to be



completed on schedule even after significant problems at the beginning of the drives where the geology was much worse than expected. At the start of the drives, the marl was found to be blocky and requiring immediate support. The marl was also permeable resulting in significant salt water ingress affecting the performance of the electrical locomotives for muck hauling and reducing the grip on the upgrades at the end of the tunnel. In this zone the choice of an unsealed tunnel lining on the UK side was put into question. On the French side, the marl was expected to be fractured and earth pressure balance TBMs with a gasketed lining were selected. These selections proved to be prudent as difficult ground conditions were encountered and the TBMs dealt with these and the 11 atmospheres of water pressure, albeit with somewhat reduced advance rates.

The Channel Tunnel costs became inflated due to several reasons mostly unrelated to the actual construction. Included in these reasons was the inefficiency of a complex organisation for procuring the project with five French Contractors and five British contractors working for a newly created company called Eurotunnel that had no experience managing a project of this magnitude. Further, the fact that the tunnel connected two countries that had a history of disagreeing created arduous decision processes. These were particularly demonstrated within the vehicle procurement when the shuttle railcars were redesigned many times, greatly increasing their cost and complexity and delaying the operation date for the facility. Therefore the Channel Tunnel cannot be used as a simple comparator to the fixed link proposed across the Strait of Belle Isle due to the size and complexity of the facility as well as the issues described above.

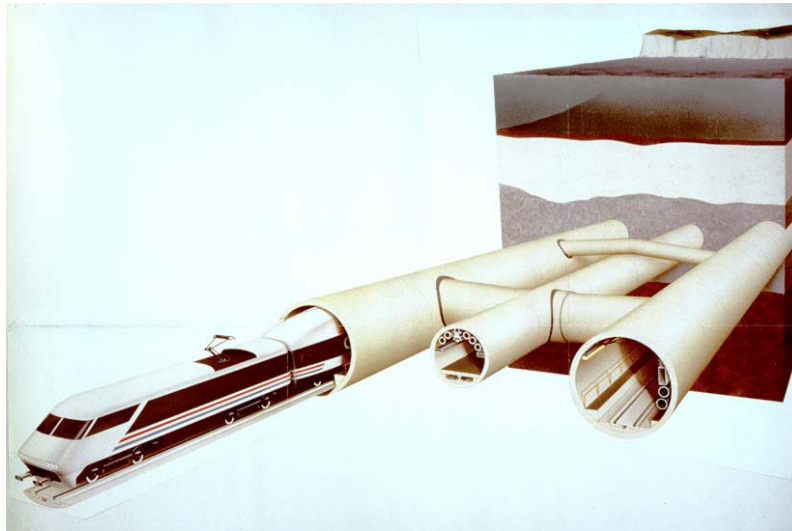

**Figure 2.3 - Channel Tunnel**

## 2.4 Lantau Link

The Lantau Link, as shown in Figure 2.4, is a series of bridges to connect the new Chek Lap Kok Airport to the Hong Kong mainland. This relatively short (3.5 kilometres) crossing is a very high capacity facility with two bridge decks, the upper deck carrying a six lane highway and the lower deck accommodating a two track rail line plus two emergency road lanes.

The main lesson learned from this fixed link is that long span suspension and cable stayed bridges can be designed for high traffic capacity and to withstand severe weather conditions in the form of typhoon strength winds.



**Figure 2.4 - Lantau Link**

## 2.5 Chesapeake Bay Bridge-Tunnel

The Chesapeake Bay, as shown in Figure 2.5, fixed link is a 28 kilometre crossing of the shallow Chesapeake Bay made up of multi-span bridge viaducts connected to an immersed tube tunnel under the shipping channel. The initial crossing was constructed in 1964 as a two-lane road structure. The two viaduct structures were duplicated in 1999 but both presently connect to the single two-lane tunnel.

The major lesson learned on this fixed link is that any structure that limits the depth of the shipping channel should be located to allow for future increases in shipping drafts. The present Chesapeake Tunnel draft will not accommodate the latest Panamax container ships and studies are underway to investigate the lowering of the existing tunnel as well as duplicating the facility. The link also demonstrates that multi-span bridges provide an economical alternative where the channel is reasonably shallow.



**Figure 2.5 - Chesapeake Bay Bridge Tunnel**

## 2.6 Confederation Bridge

The Confederation Bridge, as shown in Figure 2.6, was completed in 1997 and provides a two lane road fixed link between Prince Edward Island and New Brunswick across the 13 kilometre wide Northumberland Strait. This channel is relatively shallow at 30 metres deep and is therefore suited to a multi-span bridge. The limited amount of shipping that uses the Strait is accommodated by a single high clearance long span. The design of the bridge included allowances for ice floe loadings.

This crossing demonstrates that, where conditions are suitable, multiple span bridges can be economical. However, conditions, such as deep water, icebergs and significant shipping traffic, make their application more difficult or even impracticable.

This fixed link is also of interest in that it was built as a largely privately funded project with investment recovery through tolls and annual subsidies from government equivalent to those provided for the ferry it replaced.



**Figure 2.6 - Confederation Bridge**

## 2.7 Summary of Fixed Links

Table 2.1 provides a summary level comparison between the listed fixed links. The data contained in this table has been obtained from published sources and costs have been converted to Canadian dollars using present currency conversions and inflated to 2004 dollars using published inflation rates. Considering this process, the costs in this table should be recognised as being indications of comparative rather than absolute costs.

**Table 2.1 - Summary of Fixed Links**

	Crossing Length	Water Depth	Vehicles/day	Road	Rail	Rail Passengers/day	Year Opened	Cost \$M(2004CAD)	Cost/km \$M(2004CAD)
<b>Øresund Link</b>	22 km	30 m	9,300	✓	✓	14,800	1999	4800	300
<b>Storebælt Crossing</b>	16 km	60 m	20,600	✓	✓	30,000	1998	7700	430
<b>Channel Tunnel</b>	50 km	50 m	8,300		✓	17,600	1994	34400	690
<b>Lantau Link</b>	3.5 km		40,500	✓	✓	250,000	1997	2300	660
<b>Chesapeake Bay Bridge/Tunnel</b>	28 km	30 m	8,800	✓		-	1964	2000	75
<b>Confederation Bridge</b>	13 km	30 m	N/A	✓		-	1997	1200	90

## 2.8 Other Relevant Tunnels

Also of relevance to this study are two tunnels recently constructed in Europe. These are the Vereina Tunnel in Switzerland and the Laerdal Tunnel in Norway. These are both tunnels of significant length for relatively low traffic applications. The Laerdal Tunnel is the longest road tunnel in the world. This two lane tunnel was constructed by drill and blast techniques through gneiss. The Vereina Tunnel has a single track rail shuttle for conveying road vehicles. This tunnel was constructed partially by drill and blast and partially by tunnel boring machine, again in gneiss. Both these tunnels demonstrate the ability in Europe to build low cost tunnels. Table 2.2 shows the features of these tunnels.

**Table 2.2 Other Relevant Tunnels**

	Crossing Length	Vehicles/day	Road	Rail	Rail Passengers/day	Year Opened	Cost \$M(2004CAD)	Cost/km \$M(2004CAD)
<b>Vereina Tunnel</b>	19 km	1500		✓	4000	1999	440	23
<b>Laerdal Tunnel</b>	25 km	1000	✓		-	2000	245	10

### 3 THE PHYSICAL ENVIRONMENT OF THE STUDY AREA AND DESIGN CRITERIA/CONSIDERATIONS

#### 3.1 Climate

The climate of the study area is influenced by the continental landmass, the Gulf of St. Lawrence and the North Atlantic. Conditions are very variable and may fluctuate rapidly over short periods. The Strait is notoriously foggy during summer with generally poor visibility in July and August.

##### *Air Temperature*

Long term temperature data are available from stations at St. Anthony and Flower's Cove (on the Island) and Battle Harbour (in Labrador). The mean daily temperature in summer is about 13° C with mean maximum being 17° and mean minimum being 8° C. The maximum recorded temperature is 30° C at St. Anthony on August 11, 1995. Daily mean temperature in January and February is -10° C with the maximum and minimum daily means being -6° and -16° C respectively. The extreme minimum on record is -34° C that was recorded at Flower's Cove on February 4, 1995.

A reasonable minimum design air temperature is -30° C. The one per cent design temperature in the National Building Code for St. Anthony is -27° C.

##### *Precipitation*

The month with the greatest precipitation and magnitude varies from station to station, the highest mean monthly figure being about 125 mm at St. Anthony in September. The extreme daily rainfall, also at St. Anthony, is 88 mm occurring on September 2, 1999. The mean annual precipitation is about 1200 mm. Mean annual snowfall is approximately 400 cm and mean snow depth over the winter months is about 50 cm. The design ground snow loading for St. Anthony based on factors in the National Building Code is 4.2 kPa.

##### *Winds*

Maximum hourly wind speed recorded at St. Anthony is 97 kilometres per hour and maximum gust speed is 148 kilometres per hour. Prevailing directions are southwest in summer and northwest in winter although in April, northeast winds are more common. The 1 in 100 year design hourly wind pressure for St. Anthony from the National Building Code is 1.01 kPa.

##### *Degree Days*

Freezing degree days (below 0° C), which are indicative of ice growth potential, are 1323 at St. Anthony and 1166 at Flower's Cove.

##### *Icing*

Icing of above-water structures can occur from both atmospheric and sea spray icing and would be a consideration for bridge superstructure components and, to a lesser extent, for riprap sizing related to the causeway concept. There is literature in the public domain on both types of icing; freezing precipitation studies generally pertain to transmission and communications lines and towers, while sea spray icing pertains to oceangoing vessels. Both types of icing may occur in the area.

Newfoundland and Labrador Hydro has done significant work on freezing precipitation on the Great Northern Peninsula and in Labrador. For the study area, they recommend a design value for rime icing of 11.5 cm of radial ice on transmission lines combined with a maximum wind gust of 115 kilometres per hour.

Chaine and Skeates (1974) computed accumulations of ice on various surfaces as a function of return period for a number of locations in Canada. For St. John's Airport, the ice accumulation for a 50-yr return period was calculated to be 5.3 cm on a horizontal surface, 6.3 cm on a vertical and 3.1 cm on a 25 mm radial conductor.

A report by NORDCO (1981) on icing of a stationary, floating offshore oil platform on the Grand Banks presents a relationship between sea spray icing and height of a platform component above sea level. The authors conclude that sea spray icing would not affect components that are more than 1.5 times the wave height above the wave crest, or 15metres for a wave height of 10 m. In all likelihood, potentially vulnerable components of a bridge across the Strait would be higher than this.

### 3.2 Oceanography

#### *Bathymetry*

Detailed bathymetry of the study area was compiled from a number of surveys during the proposed Lower Churchill Development of the late 1970's and early 1980's. (Woodworth-Lynas, et al, 1992) In this work, five physiographic zones were defined. The Labrador Coastal Zone consists of the northwestern slope of the Labrador Trough (with depths of up to 115metres and width of 1 to 2 kilometres) and has generally uniform slopes of 6 to 12 per cent; Centre Banks South and North with depths from 15 to 85 metres are separated by a narrow depression 85metres deep; the Newfoundland Trough is 5 to 12 kilometres wide and from 70 to 125 metres deep; and the Newfoundland Coastal Zone, that is bounded by the coast and a linear escarpment separating it from the NF Trough. Figure 3.1 shows bathymetric contours within the intended locality of the proposed Fixed Link.

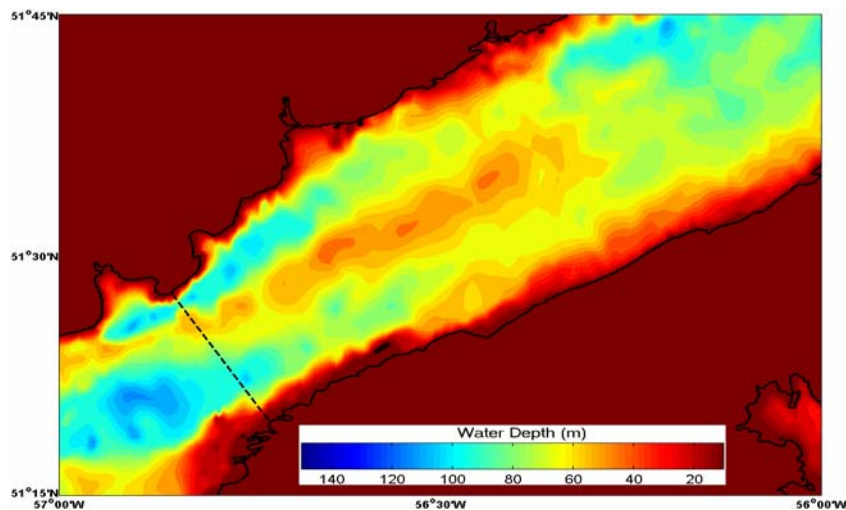

Figure 3.1 - Strait of Belle Isle - Bathymetry

### *Currents*

The earliest record of current measurements in the Strait as reported by Ingram (1982) is that of Dawson (1907,1913) who made rough measurements from a vessel without the aid of modern self-recording current meters. Dawson reported that the dominant flow within the Strait was inward toward the Gulf of St. Lawrence along the Labrador side and in the opposite direction along the Island of Newfoundland side. The first significant program of current measurement was in 1966 by the Bedford Institute of Oceanography (BIO) and as reported by Farquharson and Bailey (1966). With meters installed across a line from Pointe Amour to Savage Point, they found that the mean flow of water consisted of a surface flow (to the Atlantic) on the south side and a compensating inflow at the surface on the north side and in the subsurface waters on both sides. In 1980, BIO conducted another program of current measurements along the same cross-section with meters placed at 15 metre and 50 metre water depths. The results of this program, according to Ingram, suggest that the maximum current when all components are combined (during spring tides) are as follows:

15 metres depth	3.6 metres per second (7.2 knots)
50 metres depth	2.5 metres per second (5.0 knots)

Other current measurement programs in 1978 and 1979 in support of a proposed submarine cable crossing did not result in any more conclusive results on the current regime in the Strait. These and the drilling programs associated with the same proposed development did show, however, that with appropriate equipment, it is possible to work in the Strait during the summer and fall periods.

### *Waves*

Wave data were collected in the study area in 1979 and 1981 and wave contour charts were obtained from the Meteorological and Oceanographic Centre for Newfoundland Waters as part of the studies to support the cable crossing. A wave hindcast analysis was also carried out. The results of this work indicated that, during the period June through August, the significant wave height would be less than 3 metres, and waves with heights of 2 metres or more would occur for less than 2.5 per cent of the time. Waves with heights of 1 metre or greater would occur 40 per cent of the time. During winter, wave height will be affected by the amount of sea ice in the Strait as well as in the Labrador Sea and Gulf. Assuming no ice cover, the maximum wave height with a return period of 100 years would be approximately 10 metres and would occur in January. (SNC-Lavalin,1982).

### **3.3 Sea Ice**

Sea ice in the Strait is a combination of locally formed ice and pack ice that drifts down from the Arctic and Labrador Sea. The thickness, configuration and strength of this ice pack change with time as individual ice floes collide, freeze together, raft and ridge with changes in the current and wind. While the thickness of an individual floe that forms solely due to thermal effects would generally be less than 1 metre, this collision interaction results in formations that can be many metres thick but the average strength of such formations will be less than that of a homogeneous sheet of ice which would have a compressive strength in the order of 2 MPa. The forces that such an ice pack might exert on a structure depend on the areal extent of the ice feature, the prevailing winds and currents, the thickness and the strength of the ice feature, and the configuration of the structure with which the ice interacts.

With respect to the extent and concentration of ice in the Strait, on average, local ice first forms in mid to late December. In January, the Labrador pack drifts into the area and by late January, the coverage is seven to nine tenths. Full ten-tenths coverage may happen in a severe year and may last for up to six weeks. The pack

usually moves in and out of the Strait with the current and wind and only a small proportion of it moves into the Gulf proper. However, during persistent northeast winds, ice has been known to drift into the northeast arm of the Gulf.

Navigation by oceangoing vessels in the Strait normally continues into January although in a severe year navigation can become impeded by mid-December. Normally, navigation resumes in May although the ice may linger well into June. Local ferry operations are generally suspended from mid January to early May.

Several studies and at least one field measurement program of near shore ice conditions were conducted in support of the proposed cable crossing in the 1970's and early 80's. Thicknesses of undisturbed ice close to shore were generally less than 0.6 metres while rafted and rubble formations were several metres thick. No thickness measurements were made further out in the Strait because the central concern was the effect of ice on a submarine cable and appurtenances at the shoreline. An understanding of such thicknesses may be obtained, however, from programs conducted further north in the Labrador Sea, and in the Northumberland Strait with respect to the Confederation Bridge crossing to Prince Edward Island. In addition, information on the experience with ice around the Confederation Bridge piers since construction may be instructive in predicting ice-structure interaction behavior in the Strait of Belle Isle.

### 3.4 Icebergs

The origin and movement of icebergs in eastern Canada are generally well understood. For the purposes of this study, the concerns are with the potential for scouring and collision with bottom-founded structures. Scouring is a concern only for an immersed tube tunnel alternative crossing concept that would have shallow burial or be covered by armour stone.

A number of studies were conducted on the iceberg scour question in the 1970's and early 1980's in consideration of a submarine transmission cable from the proposed Lower Churchill development. A fundamental question relates to the potential for seabed scour at depths greater than 70 metres southwest of a shoal that is 45 kilometres upstream of the proposed crossing line. This subject is discussed at length in Woodworth-Lynas, et al (1992) and is summarized here.

Of the average of 600 icebergs that pass the latitude of the Strait each year from Baffin Bay to the Grand Banks, 60 to 90 drift into the Strait, the largest number being seen in May and June. Most of these enter on the Labrador side and exit on the Island of Newfoundland side in concert with the prevailing currents. A few of these icebergs (estimated at 6 to 12 with drafts of less than 55 metres) move into the Gulf and ground along the Quebec shore. (A few have been known to penetrate to Anticosti Island or the Bay of Islands area. One small berg reached the Cabot Strait in 1960 before melting.) The greatest number of icebergs observed in the Strait at one time was 496, recorded by the Belle Isle lighthouse keeper on May 30, 1858.

The shoal area previously mentioned was thought to act as an iceberg filter and prevent any deeper icebergs from drifting into the proposed cable crossing area. However, scours in deeper water further into the Strait have been observed, causing this theory to be questioned. A number of researchers have postulated that because icebergs roll, the previous draft may increase thereby permitting the iceberg to contact the seabed in water deeper than 70 metres. Risk analysis studies commissioned as part of the Lower Churchill program of work have suggested that the probability of an iceberg scouring along the proposed cable route is 0.5 events for every 100 icebergs in water depths greater than 75 metres and 0.1 events per 100 icebergs in depths greater than 85 metres. In the engineering studies of the cable crossing, the concept was to trench and bury



the cable out to a water depth of 85 metres. While there is some doubt about the risk associated with scour, there is also no data on the depth of scour in the area thus making a recommendation of burial depth difficult. However, there is such data from other areas and reasonable extrapolations should be possible. In recent years, significant work has also been done on the subject relating to the protection of seabed equipment on the Grand Banks.

For the purposes of the current study, researchers at C-CORE undertook an analysis of the iceberg scour risk in the Strait of Belle Isle. Iceberg scour risk and required cover depths were determined for an underwater structure running from Yankee Point in the Island of Newfoundland to Pointe Amour in Labrador. Grounding rates were determined using a grounding model that uses mean iceberg drift speed, iceberg keel depth distribution, iceberg frequency, water depth and seabed slope. Iceberg drift speed was based on 21 iceberg trajectories collected off Pointe Amour in 1979 and 1980. (Iceberg monitoring programs were conducted by LCDC over several years). Iceberg frequency was determined from an analysis of Canadian Ice Service iceberg charts from 1988 to 2004. Iceberg keel draft distribution was based on observed iceberg waterline length data collected off the coasts of Newfoundland and Labrador. Water depth and seabed slope were determined using data from a bathymetric chart.

The results of the grounding model were then used to determine iceberg risk using iceberg scour and pit data from the White Rose region of the Grand Banks. Required clearances between scouring and pitting iceberg keels were based on pipeline risk analyses from the same site. Figure 3.2 illustrates the required cover depths over the top of the tunnel as function of the mean return periods of 100 and 1000 years to prevent damage from scouring and pitting icebergs. The required cover depths over the top of the tunnel are 3 and 5.5 metres respectively, to prevent damage from scouring and pitting icebergs.

C-CORE’s report on the analysis of iceberg scour risk in the Strait of Belle Isle is provided in Appendix B.

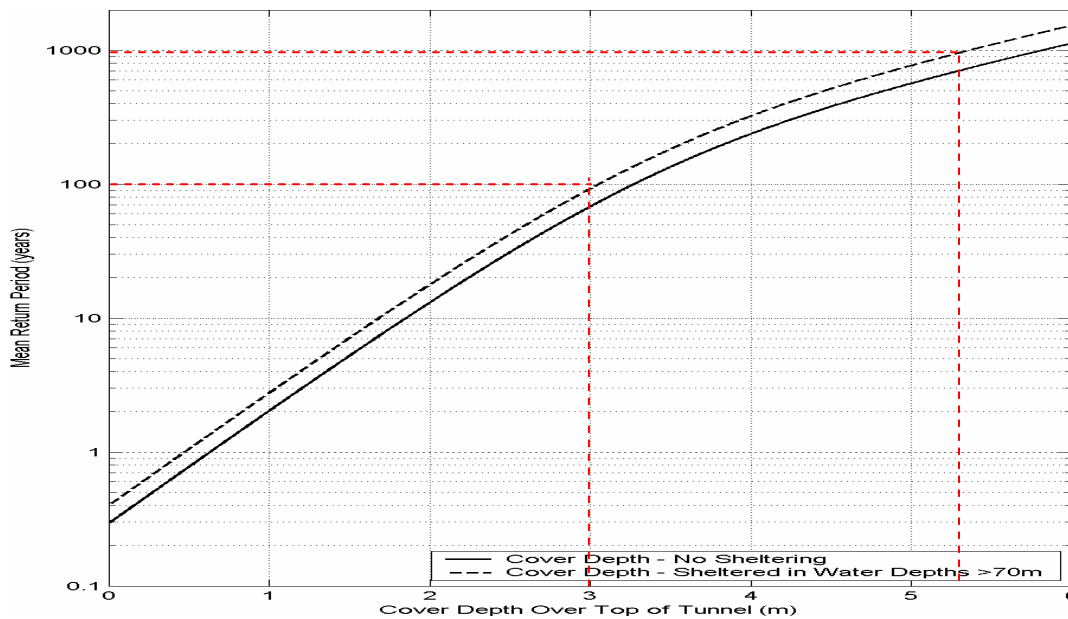

Figure 3.2 - Required Cover to Top of Tunnel to Prevent Iceberg Damage

### 3.5 Geology

An understanding of the geology of the Strait and adjacent coastal areas is obviously fundamental to the tunnel concept. The following description addresses both bedrock and surficial geology of the area.

#### *Bedrock Geology*

##### *Strait of Belle Isle*

The Strait of Belle Isle forms the northern extremity of the St. Lawrence Lowland and lies within the Canadian Appalachian region. The St. Lawrence Lowland is bounded on the Newfoundland side by the Highland of the Great Northern Peninsula and Long Range Mountains, and on the Labrador side by the Labrador Highland and Mecatina Plateau. At the narrowest width of the Strait, between Pointe Amour, Labrador and Yankee Point, Newfoundland, where the distance from shore to shore is about 18 kilometres, the area is underlain by a vertical succession of sedimentary rock strata of Cambrian age overlying Precambrian basement rock. The northern Newfoundland region has been subject to sedimentation, volcanism and orogenesis resulting in the crossing area being extensively faulted and forming a possible collapse structure. Figure 3.3 shows an inferred geological section between Pointe Amour and Yankee Point.

The basement rocks under the Strait, in Labrador, and under the Northern Peninsula are Precambrian in age. They belong to the Grenville Province and consist of a complex of metamorphic and granitic rocks. On the Newfoundland side, the complex forms the Long Range Mountains where it consists of schists and gneisses. These rocks are cut by several granitic and gabbroic intrusive and by numerous steeply dipping diabase dykes striking northeasterly. On the Labrador side, the Precambrian Metamorphic Complex forms the Mecatina Plateau. The Complex is a large area consisting of granite and granodiorite intrusives and extends from the Atlantic Ocean to beyond the Provincial Boundary.

The contact between the Paleozoic sedimentary and the Precambrian rock strata is an angular unconformity. It occurs about 95 metres below the Labrador shoreline and about 460 m below the Newfoundland shoreline. Although the contact dips gently southerly between the above two points, it is frequently offset vertically by extensive faulting occurring in the Strait.

The sedimentary rock strata overlying the Precambrian basement rock in the crossing area are Cambrian and Ordovician in age. Their total thickness elsewhere is greatly in excess of 500 metres. These strata are nearly flat-lying or gently dipping southerly and are composed of sandstones, dolomite, limestone and shale.

The sedimentary rock strata and the Precambrian basement rock have been faulted extensively as indicated in previous off-shore seismic work and field mapping during 1975. Seismic interpretative results infer that fourteen faults are present in the rock beneath the Strait between Yankee Point and Pointe Amour. The predominant set of faults strikes northeasterly parallel with the direction of the Strait. These faults have vertical offsets as is typical with normal or reverse faults. Six of the faults are located in the vicinity of the Labrador trough along the north side of the Strait and more or less parallel with the shore. Less prominent faulting occurs striking at right angles to the first set. Joint sets generally follow the fault pattern.

The entire Strait has been extensively glaciated during Pleistocene time and such features as glacial till, erratics and striations are common on the seabed. The overburden is generally composed of sand, gravel, cobbles and boulders. It appears to be generally shallow and more or less uniformly distributed throughout the area.

Bedrock outcropping is frequent. A more recent deposition of a thin layer of shells and shell fragments overlies the soil and bedrock in many places on the floor of the Strait.

*Labrador (Pointe Amour)*

From 1973 to 1975, field mapping and drilling programs were conducted in the area of shaft locations on both sides of the Strait. Mapping on the Labrador side indicated that a vertical succession of nearly flat-lying Cambrian sedimentary rock strata totaling about 170 metres in thickness overlies the Precambrian basement rock. The sedimentary rock formations are composed of about 75 metres of interbedded limestones and shales belonging to the Forteau formation. These strata overlie about 92 metres of arkosic sandstone and orthoquartzite with minor siltstone and conglomerate of the Bradore formation.

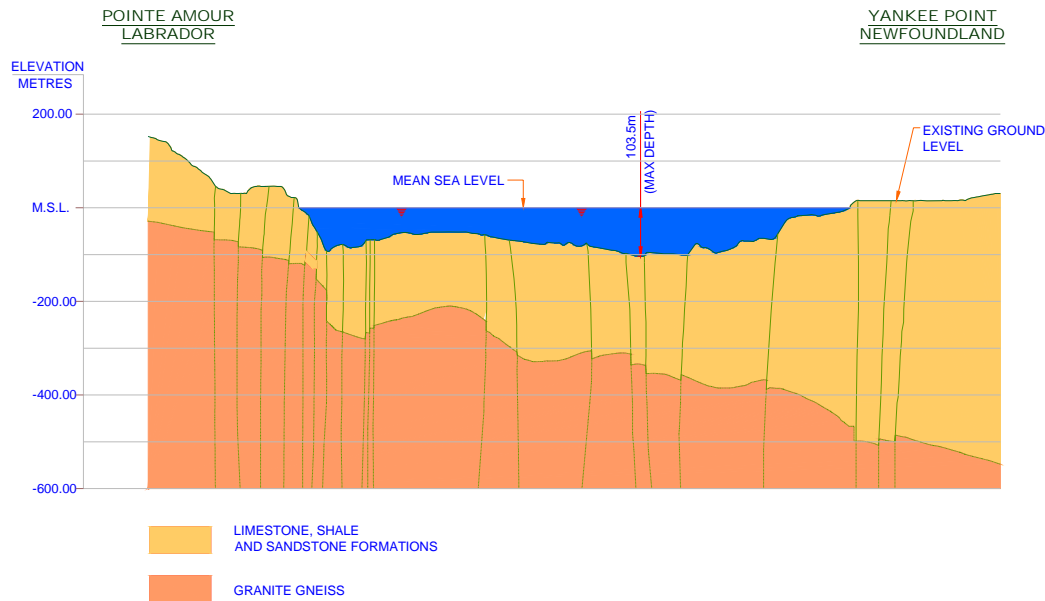

**Figure 3.3 – Inferred Geological Section Between Pointe Amour and Yankee Point**

The whole assemblage of sedimentary rock is down faulted along northeasterly trending faults strata in a series of blocks from inland to the vicinity of Pointe Amour at the shoreline. The Forteau and underlying formations are extensively faulted at Fox Point, about 1 to 2 kilometres east of Pointe Amour. The underlying Precambrian basement complex is composed of granitic gneisses and schists and intrusives of granitic composition. Surficial examination of the Forteau limestone exposures in the Pointe Amour area indicated that these strata are nearly flat-lying or dip at a maximum of 2 to 5 degrees north or south.

During 1973, a borehole was drilled at Pointe Amour to a depth of 151 metres and intersected Precambrian gneiss at a depth of 118 metres. An additional hole was drilled 151 metres west of the first Labrador hole to a depth of 301 metres in 1974; this hole terminated in gneiss. Although not drilled to the bottom elevation of the shaft at 560.5 metres the Precambrian granite gneiss is expected to continue with depth to this point and below.

Mapping of the shaft rock from an 8.5 metres deep excavation and examination of rock core recovered during drilling indicated that although there exists a slight inclination of the beds to the north or south, the strata are essentially horizontal or sub-horizontal at this location.

Seepage into the shaft collar was reported at two points, one at 1 metre depth and the other at 3.8 metres depth. The rate of inflow was estimated to range from 113 litres per minute following periods of rainfall to 9 litres per minute under normal condition and zero litres per minute during late winter.

Two sets of fractures varying in thickness from about 1 mm to about 8-10 mm were observed in the shaft collar rock. These fractures decreased in frequency in depth. The first set is subvertical with a strike and dip about parallel with the usual fracturing on surface rock. The second set is subhorizontal and reported to be very nearly parallel to the bedding.

Core recovered from the Lower Forteau indicated a high interbedded shale content in the rock from the excavated shaft collar to the top of the Bradore formation varying from 20 percent to 80 percent but averaging about 50 percent, estimated. At three locations, interbeds of pure shale were observed in thicknesses ranging from 300 mm to 500 mm. The rock throughout was generally dense and fresh except at a depth of 10.9 to 14.0 metres where the rock had a weathered appearance. At surface, trenching near the shaft area indicated that weathered shale was present. Permeability of the rock was estimated to be low.

A water-bearing zone was reported at about mid-point of the Bradore Formation between depths of 68 to 94 metres. In the contact zone between Bradore and the underlying Precambrian, a zone of very soft volcanic rocks 7 metres thick was reported.

The Precambrian complex is composed of gneisses, schists and granitic intrusives rocks. The gneisses are composed of feldspar, quartz and variable amounts of mica (muscovite and biotite). The schists are mainly micaschists. The gneiss extended from the base of the altered volcanics to the bottom of the borehole at el 301 metres. The rock is dense and fresh and displays foliation of gneissosity at an inclination of 20°, 30°, 70° and 85° fractures. Eighteen fractures zones were reported. Of these, over 70 percent occur at intervals over a vertical length of 85 metres between depths of 182 and 267 metres below surface. Of the total number of fractures, about one-third showed evidence of weathering or alteration. Of the total number of fractures, 15 percent are present to 15 metres below the top of the formation and the remainder occur in the lower 120 metres, thereby leaving a vertical distance of almost 50 metres in which very little fracturing was reported.

### *Island of Newfoundland (Yankee Point)*

The bedrock strata on the Newfoundland side are overlain by a thin layer of peat and grassland covering glacial deposits of sand and gravel containing rock fragments in size from a few millimeters up to 500 mm. The thickness of the overburden increases from a metre or so near the shore to about 3 metres inland. At Yankee Point bedrock is present about 2.5 metres below ground surface. Sedimentary rock strata (Hawke Bay, Forteau and Bradore Formations) extend from the bottom of the overburden 460 metres down to the gneiss. At the contact between the sedimentary rock and the gneiss, about 7 metres of altered volcanics or metasediments occur and these are included with the Precambrian at the top of this formation.

The almost flat-lying sedimentary rock strata of the Hawke Bay Formation outcrop along the shore at Yankee Point and overlie a vertical succession of sedimentary rock strata totaling 460 metres approximately. This series is composed of granite gneiss, feldspathic gneisses and mica gneisses. Normal and reverse faulting is

present with the downthrown sides mainly in the direction of the Strait. Downthrust and upthrust blocks along these faults have been interpreted as typical of the faulted stratigraphy of the Strait.

During 1973 a borehole was drilled at Yankee Point to a depth of 197 metres in 1973, deepened to 396 metres in 1974 and further deepened to 546 metres in 1975, intersecting the Precambrian gneiss at 469 metres. The shaft collar was excavated to a depth of 15 metres in interbedded dolomitic limestone, dolomite and shale of the upper Hawke Bay Formation. These strata are horizontal, the rock at this depth consisting of crystalline limestone (54%) shaley limestone (40%) and shale (6%). The limestone beds in the uppermost 5 metres range in thickness from 50 mm to 500 mm. The shaley limestone beds average 100 mm in thickness and contain 30 percent shale and 70 percent limestone. Grey shale lamellae range in thickness from 1 to 10 mm. Inflows into the shaft collar rock occurred at 5 metres, 7 metres and 11 metres below surface approximately at shale/limestone contacts. Inflow rates were 34, 6 and 0.5 litres per minute respectively. Fractures occur in two sets, one set parallel with the bedding and the other normal to the bedding. The frequency of the fractures was found to be greatest in the top 3 metres of the shaft collar.

Below the collar excavation, borehole cores indicated that interbedded dolomite and shale extends for a depth of 72.4 metres. The carbonate rock contains an estimated 80 percent dolomite or dolomitic limestone, 18 percent shale and 2 percent shaley limestone or limey shale. The strata appeared to be horizontal or nearly so and relatively unfractured. Shales occur mainly in the uppermost 40 metres of the formation. The rock was generally dense and fresh throughout. Permeability throughout this dolomitic formation was estimated to be low although some inflow might occur at a depth of about 60 metres where return water was lost during the borehole investigation.

Underlying the carbonate section is the lower 155 metres thick section of the Hawke Bay Formation composed of sandstones, orthoquartzites and shales. These strata appear to be flat lying. Individual bed thicknesses where no shale occurs range from an estimated 150 mm to about 450 mm. Prominent shaley beds occur at depths of 79-87, 115-124, 164-170 and 180-188 m. Other less distinct shaley strata are also present. Two sections of sandstone and/or orthoquartzite occur at 139-149 metres and 170-180 metres. These beds are very strong and massive and contain little or no shale. At the bottom of the formation, sandstone breccia about 5 metres in thickness is present along with evidence of slickensides and fault gouge dipping 20-60°, indicating that faulting is present at this point. In this respect, fractures in the rock are present at several locations extending from about 9 metres above the contact with the underlying Forteau formation to about 15 metres below the contact and these may be associated with the possible faulting or other movement along the strata in this location. The rock throughout this lower section of the Hawke Bay is dense and fresh and only slightly fractured except as noted above. Permeability was estimated to be low for the most part throughout but may be low to medium at 72-115, 139-197, and 218-222 metres.

The Forteau (dolomitic) limestone and shale formation underlies the Hawke Bay sandstone. The formation is composed of an estimated 66 percent limestone and 34 percent shale. Borehole cores indicated the limestone beds to be fairly massive and occasionally may reach a thickness of 300 to 900 mm thick in the uppermost 40 metres of the formation in those individual beds where shale content is low or absent. In the uppermost shale layer located immediately below the contact with the overlying Hawke Bay sandstone, some fracturing occurs with slickensides at 40-60°. At a depth of 337 metres, some fault gouge was reported with an oblique fracture at 40° and slickensided. Rock core recovered from this formation contained very few fractures below a depth of about 15 metres below the top of this formation. The Forteau rests conformably on the underlying Bradore Formation.

The Forteau limestone and shale is generally dense and fresh and its permeability is estimated to be low. At a depth of 245 metres, artesian salt water with gas bubbles was encountered with an average inflow rate of 54 litres per minute and a back pressure on the water feed hose of 827 kPa (120 psi) after 12 hours of capping.

The Bradore formation is 121 metres thick and deposited unconformably on the underlying Precambrian. It is 28 metres thicker than the Bradore in the Pointe Amour shaft location. It is possible that much of the increased thickness on the Newfoundland side occurs above the contact with the Precambrian where the conglomerate content appears to be greater. As on the Labrador side the rock strata were found to be generally dense and fresh. Whereas joint fractures parallel to the bedding in the Labrador shaft location have been reported as being frequent to numerous and more or less uniformly distributed throughout the Bradore, in the Newfoundland shaft rock these joints were found to occur mainly in the lower half of the formation only. Estimated permeability ranges from low to medium. Bed thicknesses are probably similar to those in the Labrador shaft and shale is present in the uppermost 5 metres of the formation directly below the Forteau. The siltstone content is probably similar to that on the Labrador side of 2 percent. At the bottom of the formation close to the contact with the underlying Precambrian, a prominent gypsum horizon is present.

About 77 metres of the Precambrian quartz-feldspar-biotite gneiss was cored at Yankee Point. The rock was found to be dense and fresh and displayed foliation or gneissosity at an inclination of 40 to 60° (true dip). A possible shear zone 600 mm thick is located 3.6 metres below the top of the gneiss. A large number of fractures and planes of weakness were reported, almost 90 percent of which are inclined at angles varying from horizontal to 20°. Of the remainder, 8 percent are inclined at 45°. The number of fractures per unit length was found to be much greater in this gneiss than that in the Labrador core. In the lower half of core recovered, a high percentage of the fractures was reported to have fresh or clean breaks so that the fractures may be reasonably tight in rock that has not been disturbed by superimposed mechanical forces such as drilling. Only one fracture of the total number was reported to exhibit slickensiding.

### *Surficial Geology*

An understanding of the surficial geology is needed for an assessment of the immersed tube tunnel concept as well as for the nearshore and offshore excavations for the tunnel approaches.

Additional information to that obtained in the programs reported above was obtained as a result of a borehole program carried out in 1981 along six potential submarine cable routes (as opposed to a cable tunnel scheme). Twelve boreholes were drilled along Route 1 between Pointe Amour and Yankee Point. The results of this drilling program show that the overburden consists of thin deposits of sand and gravel in places overlying shallow deposits of dense till. Along the route from Pointe Amour to Yankee Point, the average thickness of overburden is 1.8 metres. Including the till, the depth to the interbedded limestone and shale bedrock, is 2.5 to 3 metres. Sandstone was encountered only over a distance of 2.1 kilometres near the Newfoundland side. The amount of shale within the formation was less than had been expected from earlier assessments, indicating that the bedrock is of a relatively high strength. The work also indicated that a number of ledges and slopes were evident that would require remedial blasting for submarine cable embedment. Ledges were defined as any rock face with a slope greater than 20 per cent. Along the cable route (essentially the same as the proposed tunnel route), the number of such ridges identified was six, and the average and maximum height was 3.2 and 6.0 metres. The length of rock trenching to achieve an objective of a depth of 85 metres below mean sea level (to accommodate iceberg scour) was 11.9 kilometres (of a total distance of 17.8 kilometres), and the length of overburden trenching was the remaining 5.9 kilometres.

On shore on the Labrador side, the overburden has an estimated thickness of 1 to 3 metres and is composed of glacial till and raised beach deposits underlying a thin layer of peat and grassland. On the Island of Newfoundland side, in the vicinity of the tunnel access, the overburden consists of sand and gravel of up to 2.5 metres in thickness that is overlain by peat. The soil, which contains rock fragments ranging in size from a few millimeters to cobbles and boulders, overlies sedimentary rock strata which is approximately 460 metres deep.

### *Geological Faulting and Water Ingress Considerations*

As noted previously, the bedrock geology of the Strait has been inferred from seismic surveys and the drilling results of the shore-based program. It was also noted that, according to seismic interpretation, there are 14 faults in the structure. A further discussion of these faults and the potential for water ingress in a tunnel concept is presented in a report by SNC-Lavalin (1980) and that discussion is largely repeated here.

The faults are high angle normal (gravity) or reverse faults and their interpreted locations were shown on the profile of Figure 3.3. These faults have been responsible for upthrusting and downfaulting of individual large blocks or rock along them. Variation in vertical offsets range from a possible 75 metres in the vicinity of the Labrador trench to a possible 45 metres at the Newfoundland shore. In the vicinity of the Central Bank, vertical offsets along the faults appear not to exceed 15 metres. The faults have been interpreted as extending continuously with depth from the bedrock surface at the floor of the Strait through the sedimentary rock strata thence deep into the underlying Precambrian.

Geological mapping of the faults has indicated that those located in limestone may be associated with a zone of brecciation and fracturing up to 15 metre width. Faults in sandstone are generally not associated with brecciated zones although some brecciation is present at the bottom of the Hawke Bay sandstone a few metres above the Forteau contact. It is probable that although the depth of faulting cannot be estimated accurately from offshore seismic data, it can be assumed that some major faults have penetrated beyond the Cambrian sedimentary rocks into the Precambrian metamorphic complex. The depth of these faults is not established and it can only be concluded that some, if not all, will intersect a tunnelled crossing of the Strait.

It is also assumed that in many cases the faults in the Palaeozoic rocks have occurred along zones of weakness in the Precambrian rocks caused by existing faults of Precambrian age. Interconnections between faults of different ages are possible.

The amount of water, if any, in these fault zones and the rate at which it would flow should they be intersected by the tunnel, cannot be estimated from seismic work. Surface observations of faults indicate that brecciated and fractured zones are frequent on both sides of the Strait. In some cases zones of brecciation and fractures in the faults are recemented with secondary calcite. Such zones should be regarded as impervious. The water well drilling on the Labrador side, located approximately 240 metres west of the shaft site for the cable tunnel concept and hydrogeological studies on the Newfoundland side strongly indicate that aquifers of significant size occur only in fault or fracture zones. The water wells drilled through such zones have been productive with an estimated capacity of over 45 litres per minute while those drilled away from the fault zones were dry. This indicates that some fault zones located under the Strait might be water bearing. The risk of further movement along existing fault planes or even the occurrence of new faults is considered to be low for the Strait of Belle Isle. However, earthquakes with magnitudes of 3 to 4 on the Richter scale have occurred within 160 to 240 kilometres of the tunnel area.

The selection of the invert elevation of the cable tunnel was made so as to ensure that it would be located in the Precambrian basement rocks in order to reduce the risk of excessive water inflows into the essentially unlined drill and blast tunnel. It was assessed that sedimentary rock strata could prove to be water bearing, much more so than the underlying gneiss. Inflows into the tunnel located in gneiss were considered to be restricted to those directed along existing faulting.

In the cable tunnel cable concept, the minimum amount of granite roof cover was fixed at about 46 metres so that, with consideration of the interpretive geological profile under the Strait, 46 metres would then exist below the lowest sedimentary rock strata on the Newfoundland side. This 46 metres roof thickness measurement was apparently determined from the possible vertical offset along faulting at Flowers Cove. If such vertical offset were more than 46 metres, sedimentary rock strata might then intersect the tunnel horizon. Insofar as the tunnel invert would be located below the lowest elevation of the southerly dipping sedimentary strata, the tunnel would be located in gneiss for the remainder of the distance across the Strait.

It was considered that the individual proportions of schist, biotite gneiss, feldspar gneiss and granitic rocks cannot be estimated at this time. The foliation in the granite gneiss varies from 20° to 40° in the Labrador shaft to 40° to 60° in the Newfoundland shaft. It is possible that the content of schistose rock probably relates to the mica content in the rock and so may not be significantly large. Wherever the granitic rocks have been observed on shore and in the boreholes, the rock is reasonably fresh and unweathered. Its condition in the vicinity of faults is not known.

The 1980 studies concluded that a substantial increase in the amount of geotechnical detail would be required through additional borings.

Boreholes would be located so as to confirm the predicted amount of vertical displacement of strata produced as a result of faulting. In addition, it was considered to be of particular importance to investigate the condition of the rock at the upper and lower contacts of the Forteau Formation and at the top of the Precambrian granite gneiss on both sides of the Strait. Studies of these areas have indicated occurrence of fractures, water inflows, drilling water losses, gypsum, fault gouge and areas of soft rock as indicated on the borehole logs. In all borehole investigations on both sides of the Strait, permeability testing of the rock in situ was suggested. Two inclined boreholes were recommended on the Labrador side to intersect and partially determine the condition of the faults underlying the north side of the Labrador trench that were interpreted to extend into the cable tunnel horizon.

In addition, it was suggested that a program be conducted from the cable tunnel during the construction period by means of investigative boreholes in advance of each tunnel heading. This procedure would allow pre-grouting considerations and final design criteria to be assessed immediately in advance of shaft and tunnel construction.

### 3.6 Design Criteria and Considerations

#### *Environmental Design Criteria*

The design criteria associated with the physical environmental parameters of the study area may be summarized as follows from the above discussion.

#### *Climate*

Minimum design air temperature                      -30° C



Maximum hourly wind speed	97 kilometres per hour
Maximum gust wind speed	148 kilometres per hour
Design hourly wind pressure	1.01 kiloPascal
Atmospheric Icing	11.5 centimetres with 115 kilometres per hour wind gust
Ground snow loading	4.2 kiloPascal
Freezing Degree-Days	1323 ° C-days

### *Oceanography*

#### Currents

-at 15 metres depth	3.6 metres per second
-at 50 metres depth	2.5 metres per second
Maximum Wave Height	10 metres
-100 year return period	

### *Sea Ice*

Uniform ice floe thickness	0.6 metres
Ice compressive strength (uniform ice)	2 megaPascal

### *Icebergs*

Mass	1 million tonnes
Speed	1 metres per second
Ice strength	5 megaPascal
Scour depth (1000 year return period)	5.5 metres

## 3.7 Capacity and Dimensional Requirements for the Fixed Link

Projected traffic demand, emergency egress and ventilation are the principal factors in determining the spatial requirements of a tunnel. Each of these items is addressed below for road and rail configurations. Consideration is also given to accommodating HVDC cables in the tunnel.

### *Traffic volumes and mode of transit*

As an early activity during the study it was necessary to carry out a scoping level assessment of the traffic that a fixed link across the Strait of Belle Isle would attract in order to determine the capacity required for the facility. This assessment was made to establish the size of the structures in terms of the number of traffic lanes or the number of tracks. A preliminary forecast was made of traffic volume generated 30 years after construction. Traffic could develop from a number of sources as follows:

- ◆ Diversion from existing established routes
- ◆ New developments to attract automobile tourism and induced demand
- ◆ New economic developments to attract long term commercial vehicle traffic
- ◆ Major projects that may generate elevated demand for defined periods

The traffic that presently crosses on the existing ferry service was assumed to transfer totally to the new fixed link after the closure of that service. Further, half of the present traffic using the Gulf ferries was also assumed to divert to this crossing. This was considered to be an optimistic assumption but appropriate for an initial sizing assessment. Similarly, a generous annual traffic growth of 2.5% was assumed.

The resulting traffic volumes in equivalent Passenger Car Units (PCU) are shown in Table 3.1. Cars are considered as one PCU per vehicle and commercial vehicles are considered as three PCU per vehicle.

**Table 3.1 - Preliminary Traffic Volume Summary**

Description	Base Volume at Year 1		Sizing Volume (PCU) at Year 30
	Existing Peak per day	Diversion Peak per day	Total Daily Volume
<b>Passenger Cars</b>	160	315	2,042
<b>Commercial PCU</b>	22	350	1,621
<b>Total PCU</b>	182	665	3,642

Highway lane capacity is normally assessed in terms of peak hour volume that can safely operate in fluid conditions. For a two-lane undivided highway in Canada, the rule-of-thumb is 1,200 PCU per hour per direction.

Since the route under consideration is rural and remote, peak periods are spread over a number of hours, say 5 hours each day. During this time, 50% of the average daily volume could be accommodated and the balance of the demand would be spread over off-peak periods. Based on the above estimates of 3,642 PCU per day, the peak design hour should accommodate 364 PCU in aggregate for both directions or 182 PCU per hour per direction. This is well below the rule-of-thumb for two-lane undivided highways.

Since the expected traffic is significantly less than the capacity of a two-lane highway it is appropriate to investigate lower capacity options. An alternative to two-lanes is a managed single lane operation with periodic single direction operation. However, for the causeway or bridge alternative means of providing a fixed link, the incremental cost differential between providing a two lane crossing compared with a single lane is so small that it would not be economically feasible to construct such a facility at less than a two-lane configuration. Conversely, for the tunnelled options, the cost increment associated with providing two lanes compared with one lane is very large and there is significant justification to minimize the area of the tunnel cross sections and to select a single-lane configuration.

A single lane (with an emergency lane) could operate alternately in opposite directions in a controlled environment. An operating speed of 50 kilometres per hour would imply under 30 minutes to enter, traverse and exit the crossing. If the window of operation was 30 minutes at the entrance, with 30 minutes to clear the tunnel then after one hour the direction of operation could change after the last vehicle clears the portal. The traffic would then operate in the opposite direction for a period of 30 minutes plus 30 minutes clearing time. Therefore for 25% per cent of the time, traffic could enter in one direction, and 25% of the time could enter in

the opposite direction. This would provide a capacity of 300 PCU (1200 x 25%) per hour in each direction. An alternating-direction single-lane tunnel therefore appears to be a feasible alternative based on capacity considerations.

Based on the above, a traveller would experience a total crossing time, including waiting time, of between 30 and 90 minutes.

Another option is an electric rail shuttle, single-track operation. This could be made to operate at a higher speed than might be safe for road vehicles, (design speed assumed at 100 kilometres per hour) and it could be designed for different capacities per train. For example, in order to provide sufficient capacity for 250 vehicles per hour per direction, there would have to be two trips, each with 125 vehicles per direction. A 21-car train with six vehicles per car, and seating capacity for passengers (likely remaining in their vehicles) would accomplish this. This option is close to the upper limit of projected capacity requirements, however.

The rail shuttle option assumes a 12 hour operating day during which trains would leave Newfoundland at 30 minute intervals and would leave Labrador at 30 minute intervals. Train loading and unloading allowances are between 5 and 15 minutes depending on time of traveller arrival. The trip time has been calculated at 15 minutes. Based on this operating scenario, a traveller would experience a total crossing time including waiting, loading and unloading, of between 25 minutes and 60 minutes.

Therefore the three options to consider for costing and preliminary design are; for the bridge and causeway alternatives, (i) two lane road, and for the tunnelled options, (ii) managed one lane configuration for motor vehicle operations, and (iii) electric train shuttle operation for passenger cars and commercial vehicles with capacity for simultaneous load/discharge of at least two 21-car train sets.

## Road Tunnel

### Clearances

The traffic analysis discussed above indicated that a single-lane tunnel operated in a cycle with flow in one direction followed by flow in the opposite direction will satisfy the projected traffic demands. There are no specific vertical and lateral clearance standards for single-lane uni-directional tunnels, and in North America, general standards for clearances in tunnels are not well established. The following documents were therefore referenced in order to obtain guidance on appropriate clearance standards for the highway tunnel option:

- ♦ PIARC: World Road Association “Cross Section Geometry in Unidirectional Road Tunnels”
- ♦ AASHTO Standard Specification for Bridges, Section 2.5 Highway Clearance for Tunnels

Using the guidelines within these documents and HMM’s experience on similar highway tunnel projects, the following parameters were adopted for development of highway tunnel cross-sections:

- |   |                              |
|---|------------------------------|
| ♦ Maximum truck width                             | 2.6 metres                   |
| ♦ Maximum truck height                            | 4.2 metres                   |
| ♦ Lane width                                      | 3.75 metres                  |
| ♦ Vertical clearance from vehicle running surface | 4.65 metres                  |
| ♦ Off-roadway distance                            | 0.75 metres + shoulder width |
| ♦ Shoulder width                                  | 1.25 metres                  |

This configuration permits vehicles to pass a truck or other vehicle that has broken down within the tunnel as shown in Figure 3.4.

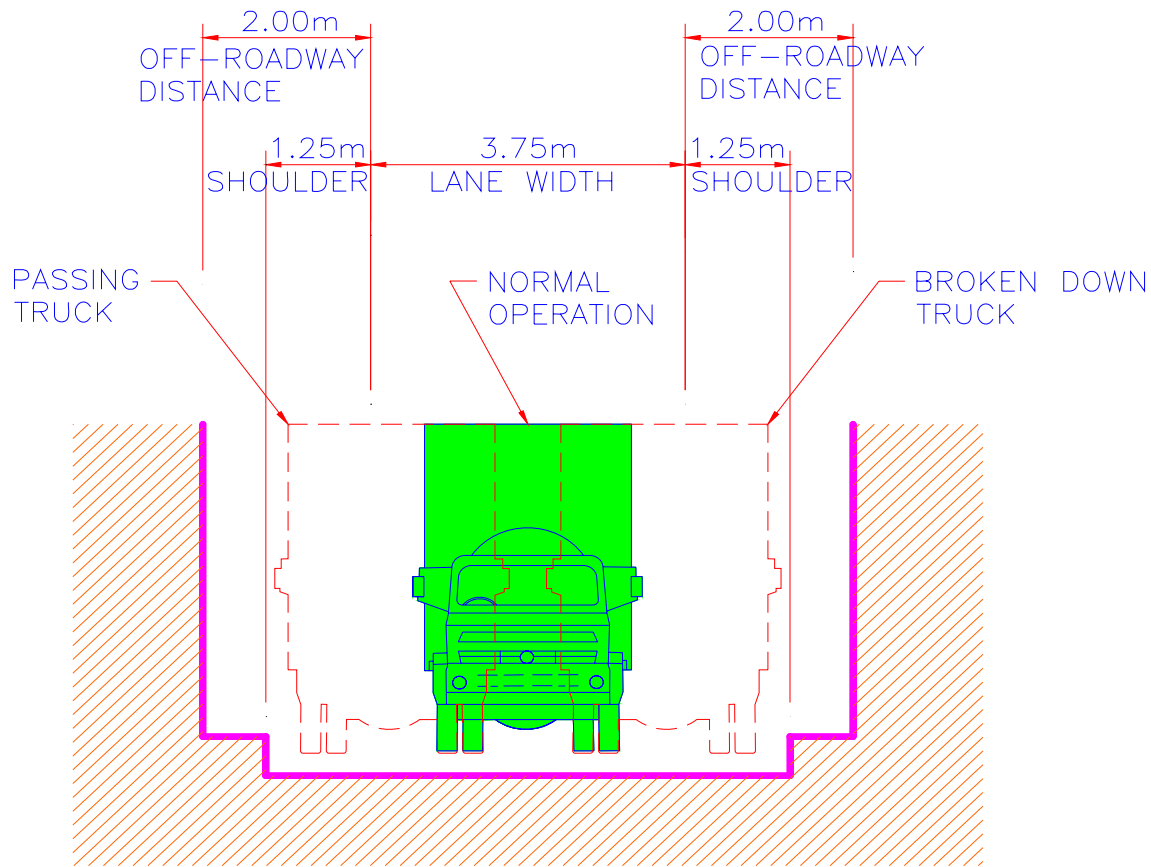

**Figure 3.4 - Road Tunnel Clearance Details**

### *Emergency Egress*

A fundamental consideration in the selection of cross-section is the provision of emergency egress from the tunnel. The National Fire Protection Agency code; “NFPA 502 – Standard for Road Tunnels, Bridges and Other Limited Access Highways” requires that emergency exits shall be provided at 300 metres intervals. With a single tunnel, this feature can only be provided by a passageway, fire-separated from the vehicular space.

### *Ventilation*

Spatial allowances for ventilation in road tunnels can have a significant impact on the tunnel dimensions. There are two principal systems for ventilating road tunnels as follows:

- ♦ Longitudinal ventilation – this system of ventilation uses jet fans spaced along the length of the tunnel to drive a continuous flow of fresh air through the tunnel. The system is only suited to short road

tunnels as required velocities to overcome frictional resistance become very high in longer tunnels. The system can be used for longer electric train rail tunnels.

- Transverse ventilation – this system of ventilation passes fresh air transversely across the tunnel at discrete locations throughout its length with separate supply and exhaust ducts being used for supply of fresh air and removal of polluted air. Such a system is generally adopted for long road tunnels.

A preliminary analysis of the ventilation requirements was undertaken assuming a 20.5 kilometre road tunnel with six percent grades and using the projected traffic from the preliminary traffic demand analysis undertaken during Phase 1 of the study. The study also recognized the planned operation of the tunnel as a single-lane facility with traffic operating periodically in one direction and then in the other direction. This analysis indicated that the optimum method of ventilating the road tunnel is likely to be a combination of longitudinal and transverse ventilation with the tunnel divided into five separate ventilation zones as shown in Figure 3.5 below. This method would have jet fans installed within the tunnel at intervals to encourage longitudinal flow. However, these jet fans alone would not provide enough ventilation for a tunnel of this length. Therefore, additional fresh air would be introduced and stale air removed at four discrete points along the length of the tunnel. These four points divide the tunnel into five ventilation zones as shown in Figure 3.5. To deliver and remove air from the discrete ventilation points large dimension conduits are required. For Zones 1 and 5 these requirements are doubled, as parallel conduits are needed to reach the inner ventilation points. In the conceptual configuration, as Zones 1 and 5 are largely under land, it may be possible to deliver this additional ventilation via shafts and parallel tunnels.

With this scheme, there would be an advantage to provide a variable cross-section tunnel with the spatial arrangement adjusted to the requirements of the various zones. This is possible for drill-and-blast excavation but would likely not be practicable for TBM driven tunnels since a change in TBM size would be required.

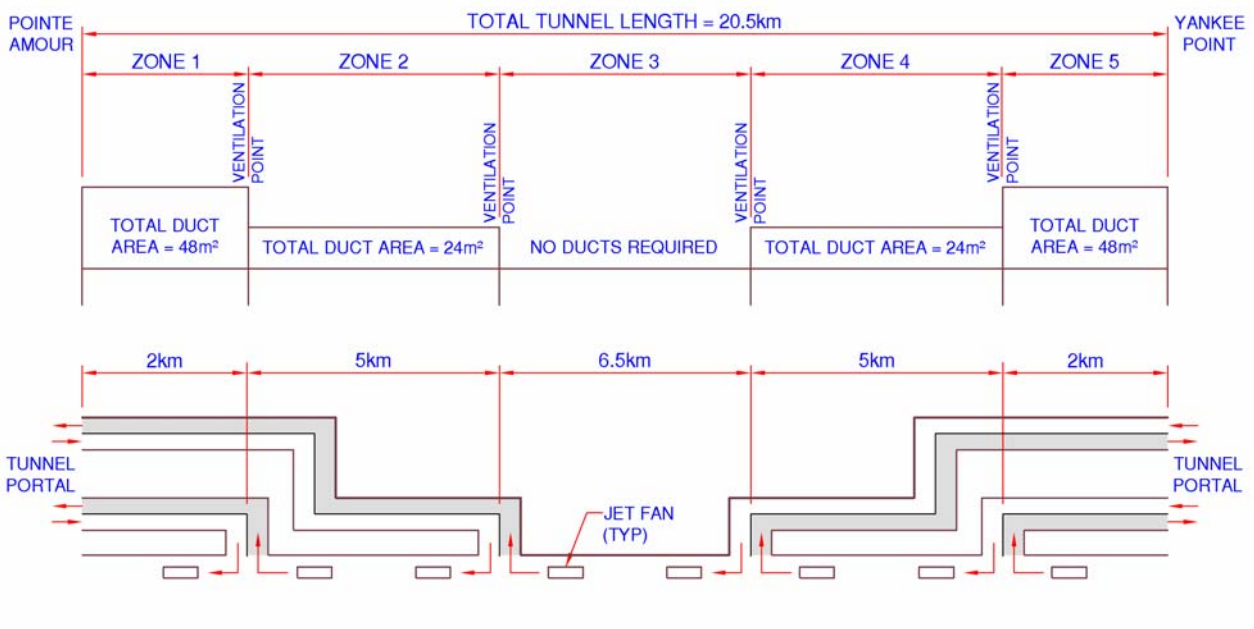

Figure 3.5 - Road Tunnel Ventilation Duct Requirements

Consideration was also given to the use of mechanical air scrubbers as a means of providing a constant supply of clean air within tunnel. This concept has been used in the Laerdal Tunnel in Norway, in one or two tunnels in Japan, and is under consideration for tunnels in Australia. Research on these applications revealed that the technology is in its infancy and that there have been problems with maintaining the scrubbers and with their high energy usage. In the Leardal tunnel, the air cleaning facility has not really been tested since the traffic and related pollutant levels have not required their use. One particular problem, yet to be resolved, is that the scrubbers only remove particulate matter and do not address other chemical pollutants. These are presently removed by passing tunnel air over beds of activated charcoal. These beds require large surface areas that are difficult to accommodate underground.

Therefore, for the purposes of this study, in-tunnel cleaning of the air has been considered to be unreliable and has not been considered further. This is an area of technology that may be more developed when this project is progressed further and should not be discounted completely if the road tunnel scheme were pursued.

### Rail Tunnel

#### Clearances

Tunnel size requirements are reasonably well defined for railway tunnels, and for the purposes of this study it has been assumed that a 'shuttle' railcar similar to that used for the Channel Tunnel and associated tunnel clearance envelope are appropriate. Figure 3.6 shows the required dynamic clearance envelope for such a vehicle.

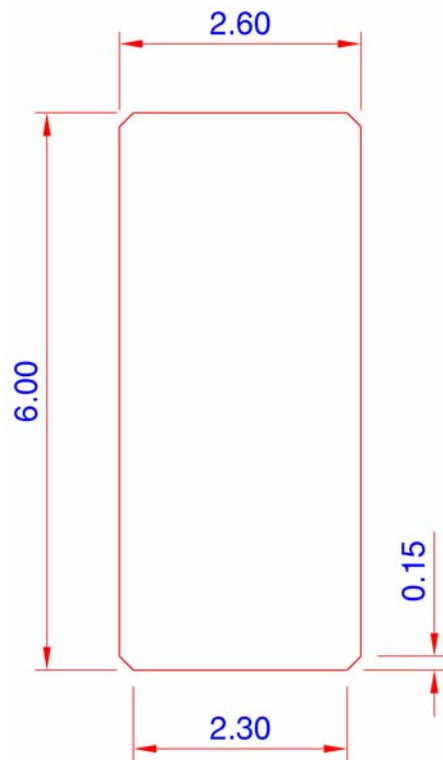

Figure 3.6 - Dynamic Clearance Envelope for Shuttle Railcar

### *Emergency Egress*

Although tunnel fires and similar emergencies are less likely to occur in railway tunnels, it is essential to provide a means of emergency escape. A continuous escape passage for the full length of the tunnel has therefore been provided. The National Fire Protection Agency code, NFPA 130, requires that emergency exits be provided at 240m intervals.

### *Ventilation*

Preliminary analysis of the ventilation requirements for the railway tunnel option was based on the use of electric trains and 1.5 percent grades on either side of the Strait. A 27 kilometres long railway tunnel can be adequately ventilated using longitudinal ventilation with jet fans distributed along the tunnel.

### *HVDC Cabling Requirements*

The proposed fixed link could accommodate the installation of High Voltage Direct Current (HVDC) power cables, a component of the proposed transmission link between the Island of Newfoundland and the proposed hydroelectric developments on the lower Churchill River in Labrador. The expected basic parameters of the transmission system as provided by Newfoundland and Labrador Hydro are as outlined below:

- Power transfer capacity of the link 800 MW.
- Proposed circuit voltage +/-400 kV
- Minimum nominal cable current capacity 1000 Amperes
- Nominal cable power capacity per cable 400 MW
- Number of cables proposed in service 2, one positive, one negative
- Number of spare cables 1, connectable positive or negative.
- Circuit length, Gull Island to Soldiers Pond 1100 kilometres

The aerial (overland) component of the circuit is not the subject of this discussion, but for interest sake it may be assumed that each pole of the circuit, positive and negative, will be composed of 2 conductors with roughly 2000 Amperes total capacity to allow for possible temporary overload operation of 800 MW per pole. The conductors would probably be ACSR of a size range between 1033 and 1590 kCMil.

Each cable in the tunnel is expected to be capable of carrying 1000 Amperes, on a steady state basis, with temporary overload capability for between 10 to 20 minutes of 2000 Amperes. It is expected the cable would thus be oversized to some extent to allow for this overload capability; a rating of 1150 Amperes was proposed in previous design exercises. There are a limited number of different cable types that could be used for the cable circuit, as listed below:

- High-pressure pipe-type cable, either gas or oil-pressurized
- Gas pressurized cable
- Low-pressure oil-filled cable
- Solid dielectric cable

These various cable types have been reviewed in detail in the engineering studies referred to previously. The high-pressure alternative was not favoured on the basis of high cost, and the lack of applicability of this cable type to dc cable circuits, particularly those in protected environments such as tunnels. The gas-pressurized

paper-impregnated cable type has existed for many decades, and experience has generally been favorable; however, its use has been limited. As there is very little of this type of cable being manufactured at this time, and there are concerns with its use in cases where significant elevation changes occur, due to cable impregnation compound migration, this cable type was also not favored. The cable type that was recommended previously is the low-pressure oil-filled type of cable. This cable has been in use for many decades and it is still the only cable that is normally considered for ac circuits at the 500-kV voltage level. The use of this type of cable is of concern when proposed for use over routes that have a significant variance in elevation. There are, however, existing well-proven design practices that allow a solution to these problems. For instance, the Churchill Falls Powerhouse has some thirty-three 230-kV low-pressure oil-filled cables with approximately 300 metres in elevation difference from one end to the other, and these have proven satisfactory in operation for more than 30 years. Thus, this cable type can be considered suitable for use in the current application.

The fourth type of cable, solid dielectric power cable, meaning cable with cross linked polyethylene insulation was not considered suitable during the original engineering study because its reliability wasn't considered proven at the proposed voltage level. In the intervening years, solid dielectric cable designs have been the subject of much improvement; and they have now come into common usage at the 230-kV ac level, and they are also being used fairly routinely at the 345-kV ac level. The cable in the tunnel, operating at +/-400-kV dc, would be subject to voltage stresses slightly above standard 230-kV ac levels; however, solid dielectric cables should be considered suitable for use in the fixed link tunnel at this time. As this type of cable has no liquid in its composition, the major problem experienced with oil-filled cables, namely excess pressures inside the cable due to changes in elevation, would not exist. One benefit of using solid dielectric cables is that the elaborate fire prevention and extinguishing systems needed with oil-filled cables are not essential, although some fire detection measures are required, because cross linked polyethylene does burn, and when doing so it gives off noxious gases.

A nominal conductor size of 800 mm<sup>2</sup> copper, or 1150 mm<sup>2</sup> aluminum, should be adequate to provide a continuous nominal current rating of 1150 Amperes for both the low-pressure oil-filled cable type, or the solid dielectric cable type. Copper has been the more commonly used conductor material in the past; but aluminum is becoming used more often, due to its lower cost and lighter weight. Copper conductor, oil filled cables, would have an outside diameter of approximately 100 mm, with the aluminum conductor alternative being slightly larger.

There are a number of different ways in which the cables can be supported within the tunnel. The original design study assumed the cables would be laid in open concrete trenches, presumably located to one side of the tunnel. Two other ways of installing the cables would be to either fix them to the side walls or ceiling of the tunnel using appropriate supports. Hardwood clamps dowelled into the walls or ceiling of the tunnel have proven suitable in previous installations; or the cables could be supported as they traditionally are in underground mines, by suspension from strands supported from dowels in the walls or ceiling of the tunnel.

The space envelope required in which to accommodate HVDC cables would be in the order of 1 metres along the face of the tunnel by 300 mm deep. The space needed for splicing would be larger than this envelope. The splices should be staggered so that they are not all in the same longitudinal space. When finished, a splice itself, along with its two companion cables, would not require an area significantly larger than the envelope described above. In order to make a splice, a minimum working space approximately 6 metres long by 2 metres wide would be required, with an appropriate height allowance for working room. Once the splices are made, they should be permanent and need no further attention; but to cater to the possibility of a splice failure, provision would have to be made during the construction phase of the project to replace one or



more splices if needed. Replacement of a splice could take as long as a week. Given the size of the cable to be installed, a reel length of between 800 to 1000 metres may be assumed. During the actual execution of the work, every reasonable attempt should be made to maximize the reel length employed so as to ensure the minimum number of splices, which will be the most failure-prone portion of the circuit, as well as the most time-consuming portion of the installation exercise. Enough spare splicing materials should be kept near the site to ensure a replacement splice can be installed if, and when required, without a significant wait to obtain suitable materials.

## 4 ASSESSMENT OF ALTERNATIVE FIXED LINK CONCEPTS

Three basic link concepts were studied; these are, a bridge, a causeway with bridges, and a tunnel. In the case of a tunnel, the options were further divided into bored, drill and blast, and immersed tube methods of construction. Both road and rail modes were considered for the tunnel option. Each of these concepts is addressed in this section of the report.

For each of these concepts, the route across the Strait was taken as that between Pointe Amour and Yankee Point, which is the shortest distance at 18 kilometres. Water depths are actually less in an area about 20 kilometres east of this line; however, the distance across the Strait in this latter location is 27 kilometres or 50 per cent greater. This would be of most importance to a bridge or causeway concept in terms of cost reduction with lesser impact on a tunnel concept (hydrostatic pressures in the tunnel would be reduced in shallower water); however, a preliminary assessment suggests that the longer distance would more than offset any savings in costs due to smaller water depths. Therefore, for this pre-feasibility level analysis, the shorter route was used for all concepts.

### 4.1 Bridge

A bridge crossing of the Strait presents very large risks, the key engineering, construction, and operating challenges being:

unprecedented design and construction conditions for a bridge; as far as is known, no bridge has ever been constructed in an iceberg zone

the need for deep foundations in a deep-sea channel affected by large currents

difficult weather, sea and ice conditions with considerable risk to construction and the potential for delaying the construction schedule.

the risk of closure during operation in winter for significant periods due to weather conditions. Weather conditions will also make maintenance difficult; hence, any design must minimize maintenance requirements.

For a crossing of this length across a navigation channel, a combination of multiple medium spans (100 + m) and long span cable supported bridges would typically be required as this combination would reduce the number of very expensive foundations. However, in this particular case, since all foundations would have to be protected against iceberg impact, it would be more appropriate to consider a series of long spans between artificial islands or otherwise protected foundations to minimize the very extensive protection works.

Because of the water depths in the Strait and the need to minimize the exposure of structures to iceberg loadings, it is clear that the greatest possible spans and, hence, a suspension bridge would be used.

The suspension bridge concept is shown in Figure 4.1. The arrangement has seven individual back-to-back suspension bridges, each 2 kilometres in length. Such an arrangement requires 8 intermediate piers, and results in a lateral clearance of 2 kilometres between piers. There is a shore anchor on the Labrador side and a viaduct to accommodate the elevation difference on the Newfoundland side. A 50-metre clearance is used between the bridge deck and sea level to accommodate vessels and icebergs. Such a clearance should also be

sufficient to prevent significant amounts of sea spray from contacting the deck. Components would have to be designed for atmospheric icing, however.

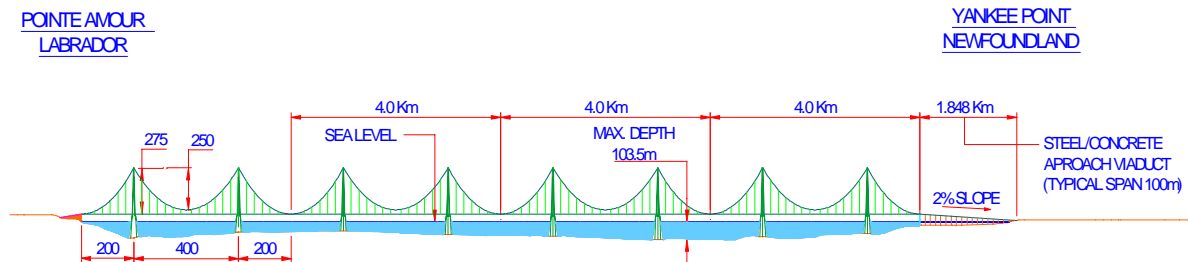

**Figure 4.1 Suspension Bridge Concept**

The foundations would be precast concrete caissons typically constructed in a dry dock and then towed to site and sunk onto specially prepared areas of the seabed. Preparation normally involves drill and blast and dredging to create a “notch” for locating the pier caisson. Concrete infilling and grouting are then undertaken to complete the foundation. The piers would be constructed by cast-in-place concrete techniques, likely using slipforming. Suspension cables would be spun using methodologies that have become normal for suspension bridges. The deck sections would be prefabricated, brought to site and hoisted to position and attached to the hanger cables. The anchors at each end of the multi-span bridges would be very substantial structures.

All of the bridge piers would have to be protected by berms in order to withstand impact forces from icebergs. These berms would also have to be protected by armour stone in the wave zone. The size of stone for wave protection is generally well understood; for the design wave in the study area, a stone weight of 15 to 20 tonnes would be needed. Two layers of such stone would be used over a total height of 20 metres (10 metres above and below mean sea level); the stone would rest on a ledge created in the rockfill at a depth of 10 metres. Below this depth, the berm would be protected by stone of a nominal 1 metre in diameter (1.4 tonnes) to assist in absorbing iceberg loads. Assuming berm slopes of 1.8 horizontal to 1 vertical and a top diameter of 15 metres, the total volume for each berm would be approximately 4.7 million m<sup>3</sup>. Such berms would further narrow the 2 kilometres wide shipping channel as the toe of the berm would extend about 200 metres from the pier. The effect of the piers on the current regime is not known but would require study if the concept were deemed feasible.

The cost of the pier protection works was based on broad unit costs for quarrying, transporting and placing rockfill and armour stone. For general angular rockfill, a unit cost of \$50 per m<sup>3</sup> was used for placement at sea; for the larger armour stone, \$100 per m<sup>3</sup> and \$200 per m<sup>3</sup> were used for the 1.4 tonne and 15 tonne stone respectively. There is no known precedence for placing such large armour stone at sea, and it is quite possible that this unit cost is low. (See a recent survey of armour stone pricing in Newfoundland by Meyer Industrial Mineral Consultants.) In any event, the much larger quantities of smaller rockfill mask the cost of the armour in the costing exercise. Based on these unit costs, the total cost of the protection works for each pier is approximately \$260 million. For eight piers, the cost would be \$2.08 billion.

For bridge foundations and superstructure components, unit costs were developed from the experience of HMM on other bridge projects, with appropriate weighting for this application. The total cost of the bridge concept, including protection works, would then be \$4.23 billion. This assumes 25% construction contingency, \$15 million pre-design costs, and 17% applied to the overall estimate for design, construction management, and owner’s costs.

Figure 4.2 details the highway cross-section used for the bridge and bridge / causeway options. This cross-section assumes that the bridge would be constructed as a suspension bridge, and provides two 3.75 metres wide lanes with 1.25 metres wide shoulders on a 10 metres wide bridge deck.

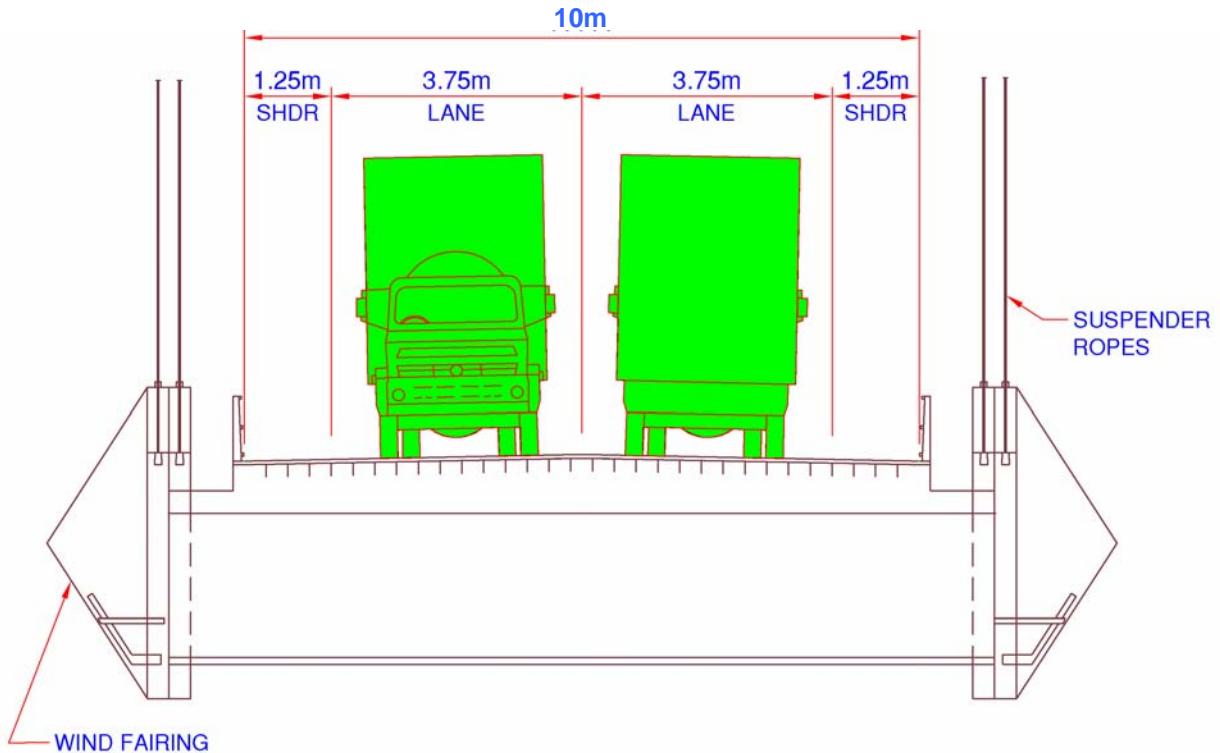

Figure 4.2 - Highway Bridge Cross Section

#### 4.2 Causeway

A causeway across the Strait of Belle Isle would be an ambitious undertaking, although with possibly lower risk from a design and construction point of view than is the case with an all bridge concept. While a causeway would still need one or more bridges, it could cope more easily with ice and icebergs and the bridge piers could be integrated into the causeway for protection. Foundations and anchoring for the bridges would still be very challenging; however, the number of foundations would be less. Overall, although working in the same hostile environment, the risk to construction schedule would likely be less with this concept. Maintenance risk should also be less since there would be fewer bridge components to maintain. However, an obvious major environmental risk is the possible effects that such a structure could have on the current regime in the area, short term weather conditions and longer term climate. This would be a major subject of study if such a concept were to be addressed beyond this pre-feasibility level. Any further study would also need to identify sources for the massive amount of rock required for the construction.

A causeway would be designed with openings to accommodate shipping and currents. For the purposes of this study, it has been assumed that two openings would be needed in the causeway as shown in Figure 4.3 and that these would be located at the position of the shipping lanes shown on the marine chart for the area.

The concept proposed here involves construction of rock fill berms from each shoreline, with two suspension bridges spanning the shipping channels to an inner berm that would be constructed using a marine plant.

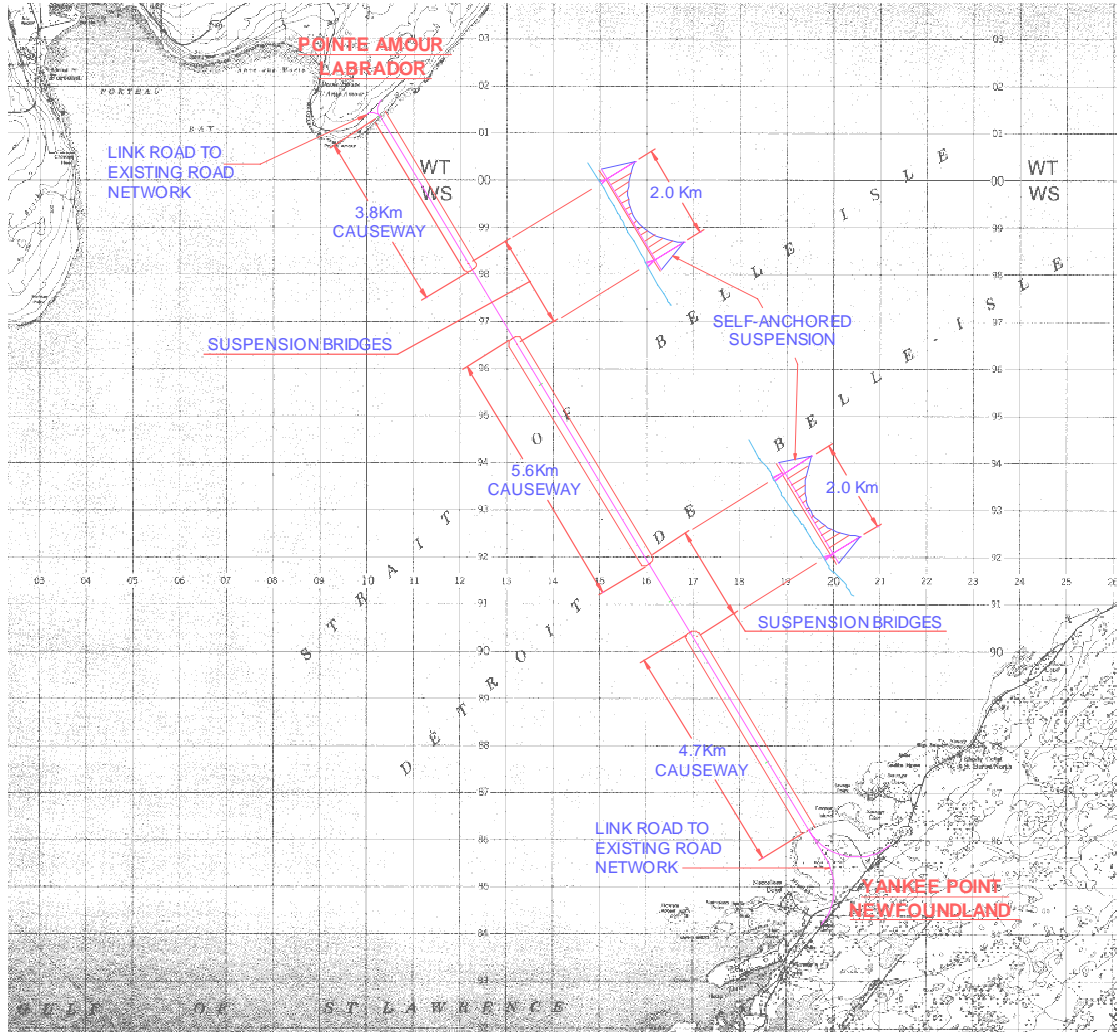

**Figure 4.3 Causeway Arrangement**

Assuming use of 2 kilometres long main span suspension bridges results in a 3.8 kilometres long berm on the Labrador side, 5.6 kilometres in the middle portion, and 4.7 kilometres on the Newfoundland side. The bridge span is less than the width of the shipping channels shown on the chart (and the toe of the causeway would also encroach into the shipping lane) but is a reasonable approach to determine concept configuration and costs. The causeway sections on either side of the Strait would be constructed from the shore by end dumping, while the mid section would have to be placed by ships or barges at considerably higher cost. The concept also features a 670 metres long viaduct section on 6% grades at both ends of each bridge in order to provide the change of elevation between suspension bridge and causeway sections. The viaduct substructures would be located above the causeway in these transition zones, with friction or end bearing piles penetrating the causeway to form the foundations to the viaduct structures.

During the construction, a method of handling encroaching icebergs would have to be devised for certain of the operations; this may be a matter of implementing an iceberg management program to monitor and tow icebergs away from the construction area. The oil industry operators routinely do this on the Grand Banks, although currents in the latter area may not be as much of a concern for towing as they could be in the Strait of Belle Isle. Once completed, the berms would arrest the motion of icebergs and prevent any contact with the bridge piers. The movement of water through the bridge openings may result in increased iceberg drift through these areas and possibly a greater incidence of icebergs south of the link. This is another issue that would require study if the concept were advanced beyond the present pre-feasibility stage.

The causeway composition as shown on Figure 4.4 would be similar to the protective berms for the piers in the bridge concept - rockfill with larger armour stone for wave protection to a depth of 10 metres and smaller armour stone to the seabed. Based on a road top surface 15 metres wide and 10 metres above mean sea level, and a side slope on the rockfill of 1.8 to 1, the total volume of rockfill would be 119 million m<sup>3</sup> for the two shore sections and 61 million m<sup>3</sup> for the mid section for a total volume of 180 million m<sup>3</sup>. Assuming rock can be quarried, transported and end-dumped for \$15/m<sup>3</sup> (in place), the cost of the two sections from shore would be in the order of \$1.78 billion. The cost of a marine dumping operation is assumed to be \$50 per m<sup>3</sup> so that for the mid-section, the cost of rockfill placement would be \$3.56 billion. The cost for the rockfill for the three berms over the 14 kilometres would then be \$5.59 billion.

The volume of large armour stone, based on two layers of 15 tonne stone, would be 1.6 million m<sup>3</sup> and the volume of smaller armour stone would be 3.3 million m<sup>3</sup>. Quarrying, transporting, and placing the armour stone, because of its size, would be considerably more demanding and costly than the rockfill. An average cost of \$100/m<sup>3</sup> is assumed here for the larger stone for the two nearshore sections and \$200/m<sup>3</sup> for the mid-section. The smaller armour stone is assumed to cost \$50/m<sup>3</sup> for the two shore sections and \$100/m<sup>3</sup> for the mid-section. The cost of placing two layers of both sizes of stone would be \$572 million. The total cost of rockfill and armour for the three causeway sections would then be approximately \$6.16 billion.

Including the costs of the suspension bridges and approach viaducts, the total cost of the causeway option would be approximately \$10.1 billion. This assumes 25% construction contingency, \$15 million for planning and preliminary design, and 17% applied to the overall estimate for detailed design, construction management and owner's costs.

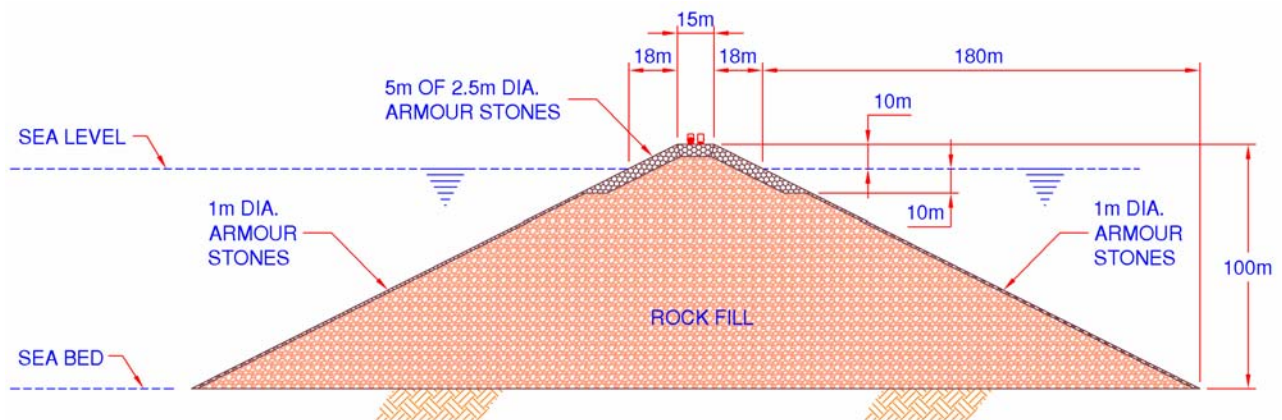

Figure 4.4 - Causeway Cross-Section

### 4.3 Tunnels

Most of the risk factors associated with a surface crossing of the Strait of Belle Isle are eliminated with a tunnel that is constructed below the seabed. For an immersed tube tunnel (ITT), the risk of iceberg impact still exists if the depth of immersion is not sufficient. However, the tunnel elements would have to be protected either by being buried below the depth of iceberg scour or by having sufficient protection to absorb the energy of an iceberg if elements are laid on the seabed or at shallow immersion depths.

One of the primary risks associated with drill-and-blast or bored tunnels relates to the potential for water ingress through faulted and fragmented rock. For the electrical transmission cable tunnel, planned in the 1970's, the concern related to water ingress and caused the selection of a deep alignment for the tunnel at 400-500 metres below sea level. This placed the tunnel in the Precambrian gneiss layers that were considered to be significantly less permeable than the sedimentary rock layers above. For this cable tunnel, the deep alignment, with shoreline shaft was a viable alternative. For a transportation tunnel, such a deep alignment with typical downgrades and upgrades would result in a length that would cause a tunnel to be prohibitively expensive. Fortunately, developments in tunnel excavation techniques in the last 20 years have made possible a shallower tunnel within the sedimentary layer.

For the drill-and-blast tunnelling, water ingress must be reduced by grouting ahead of the tunnel face to seal water paths. This is not absolutely reliable in preventing water ingress and therefore an alignment below the sea bed at approximately 60 metres has been selected for this study. For the bored tunnel option, the tunnel lining is installed immediately as the tunnel is progressed and water ingress is prevented, hence the tunnel may be constructed closer to the seabed level.

#### 4.3.1 Bored Tunnel

A bored tunnel would be constructed by an earth pressure balance tunnel boring machine (TBM). This type of TBM is designed to apply pressure to the excavation face to support the ground and to counteract water pressure in fractures and fissures. For this type of machine, the selection of the vertical alignment for the tunnel requires a decision between installing the tunnel close to the sea bed to reduce the hydrostatic pressure acting on the machine or to lower the alignment at the risk of increasing hydrostatic pressure but improving separation between the tunnel and the sea bed. For this study, the highest practicable alignment, at about 10 metres cover to the sea bed, has been selected. At this elevation the tunnel would be exposed to about 11 atmospheres of pressure, a level that has precedent on the Channel Tunnel.

A 'state of the art' earth pressure balance TBM, as shown in Figure 4.5, is capable of excavating the tunnel with minimal ingress of water and it does this by means of an auger screw for muck removal that penetrates a sealed bulkhead just behind the machine's rotating cutter head. The muck is held in front of the bulkhead by controlling the speed of the auger to create the support pressure at the excavation face. Excavated material from the rotating auger at the tunnel face would be deposited onto a conveyor belt, that in turn feeds muck cars that are hauled to the surface by locomotives. The cutter head would be fully configured for rock conditions, with rotating disk cutters used to ensure efficient cutting at the tunnel face. This type of machine is very suitable for use within the sedimentary rocks to be found within the Strait of Belle Isle crossing. These machines have frequently been configured to efficiently excavate these materials. The machines will be equipped with cutting tools specifically designed to handle the limestones and sandstones and will be protected with abrasion resistant plates to minimise the effects of the abrasive sandstones.

As the tunnel is advanced, the tunnel is lined with bolted precast concrete segments that are used in combination with the TBM. These lining segments are erected within the tailskin of the machine and therefore ensure that the tunnel workers have overhead cover at all times. The concrete segmental rings form the final lining to the tunnel and are generally made from high performance concrete with pre-installed rubber gaskets capable of fully sealing the joints between adjacent segments, and therefore permit construction of a watertight tunnel. Such precast concrete segmental tunnel linings would be manufactured in a local pre-casting facility.

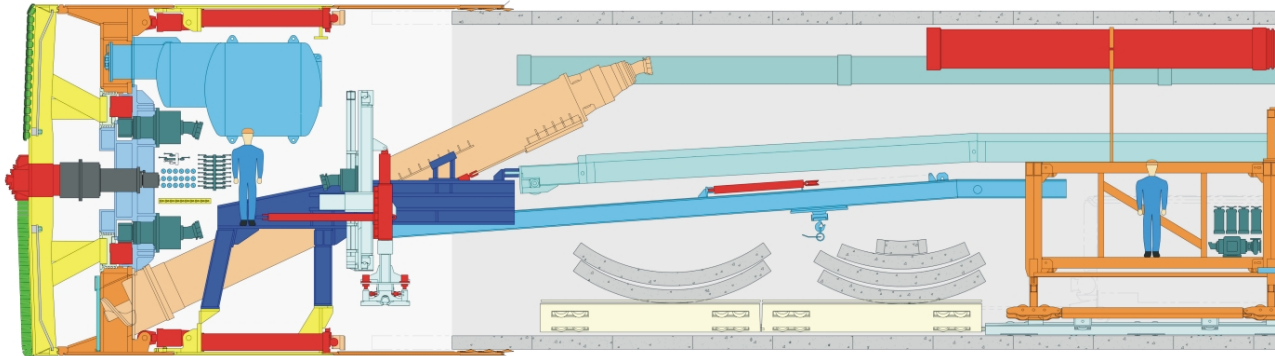

Used by permission of Lovat Inc.

Figure 4.5 - Schematic Detail of Earth Pressure Balance Type TBM

Vertical profiles for both road and rail tunnels are shown in Figures 4.6 and 4.7 respectively. The variation from one to the other is due to the flatter approach grades required on the railway tunnel.

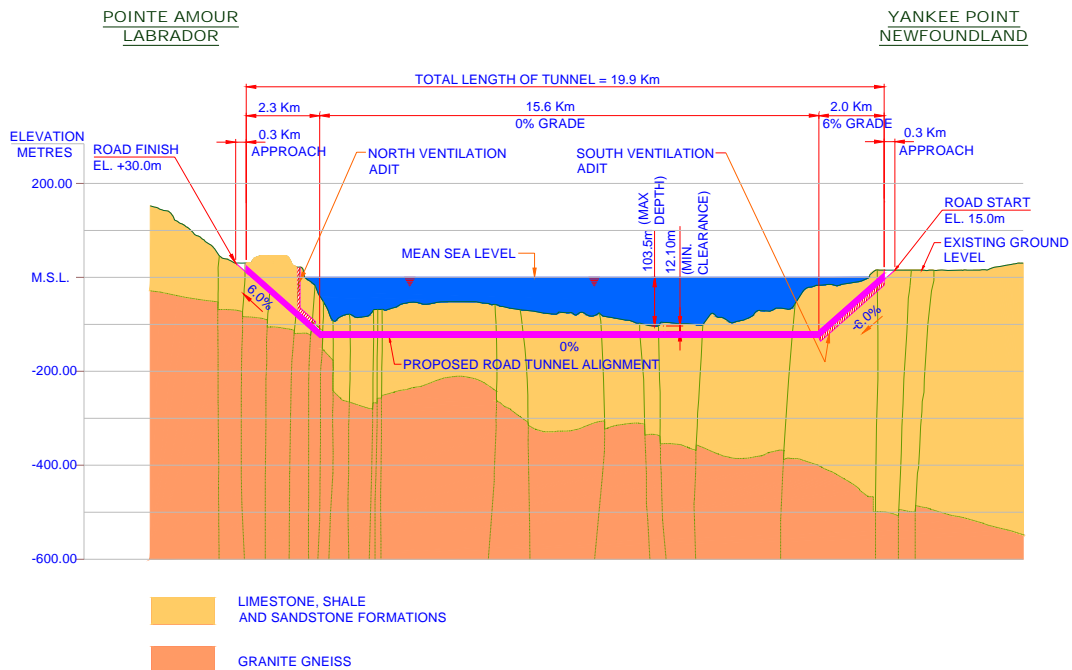

Figure 4.6 - Vertical Profile for a TBM Bored Road Tunnel



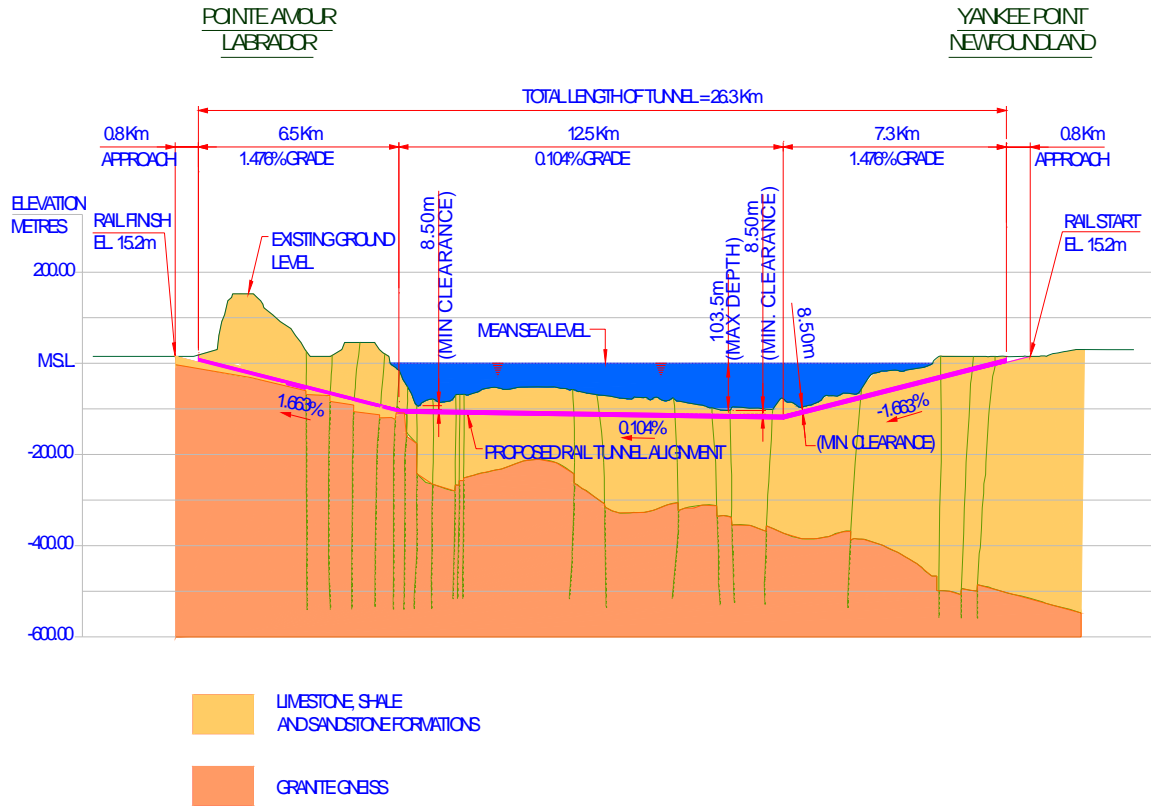

Figure 4.7 - Vertical Profile for a TBM Bored Rail Tunnel

The cross-section shown in Figure 4.8 for a bored road tunnel allows 24 m<sup>2</sup> of total ventilation duct space, and therefore fulfils the duct area requirements for ventilation zones 2, and 4 and exceeds that for Zone 3 (as identified in Section 3). It has therefore been assumed that ventilation adits will be constructed alongside the tunnel within ventilation Zones 1 and 5. It can be seen that this ventilation requirement contributes significantly to the tunnel internal diameter requirement of 11.0 metres

Figure 4.9 shows the conceptual cross-section for a bored rail tunnel. It can be seen that the rail cross-section benefits from the reduction in ventilation requirements and spatial requirements for the vehicles giving a much smaller internal diameter of 7.5 metres.

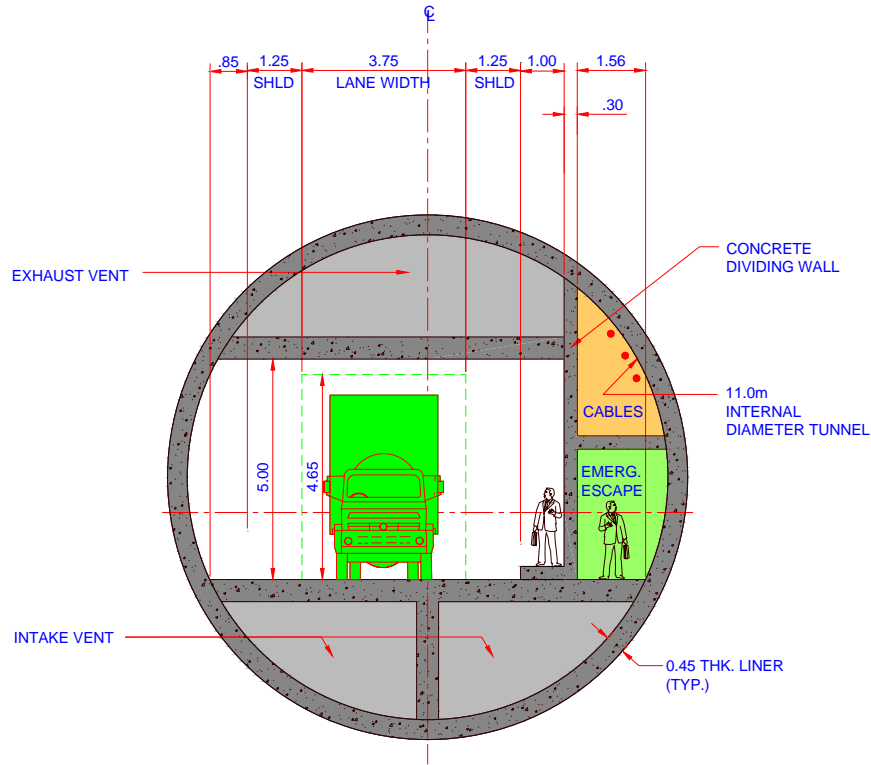

Figure 4.8 - TBM Bored Road Tunnel Conceptual Cross Section

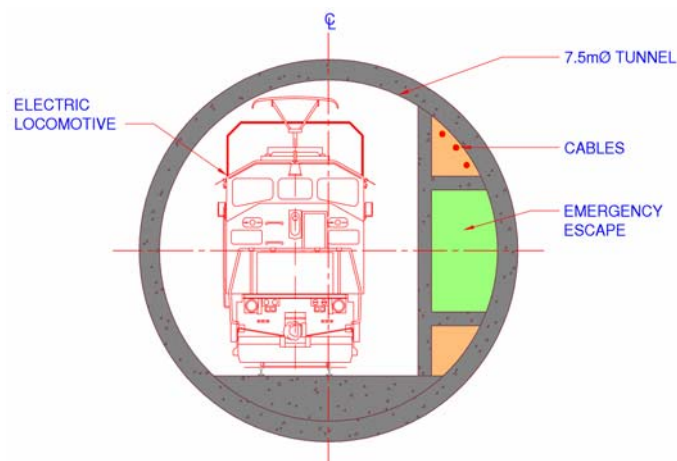

Figure 4.9 - TBM Bored Rail Tunnel - Conceptual Cross Section

*Approaches*

Figures 4.10 and 4.11 show representative, not-to-scale conceptual layouts (overlaid on topographical maps) for the north (Labrador) and south (Island of Newfoundland) approaches for the bored road tunnel concept. These layouts show approximate tunnel portal locations, proposed locations of vehicle waiting areas, new roads, and points of connection to the existing road systems on either side of the Strait. It is anticipated that

these layouts would be broadly similar for the drill and blast tunnel, immersed tube tunnel, bridge, and causeway options. The latter two would not require vehicle waiting areas, however.

The north approach has a 6% grade, which permits it to connect with an existing access road to Pointe Amour, which also has a similar grade. Assuming 6 metres of cover over the tunnel at the portal location, a 33 meters long reinforced concrete box approach structure will be required to connect the tunnel to the existing access road. For the current conceptual cost estimating purposes, it has been assumed that the excavation for the approach structure will be undertaken using drill & blast techniques.

The south approach also has a 6% grade with the tunnel ‘daylighting’ some 500 metres inland from the Newfoundland shore. A 330-meters long reinforced concrete box approach structure, also assumed to be excavated using drill & blast techniques, connects the bored tunnel to existing ground level at Yankee Point.

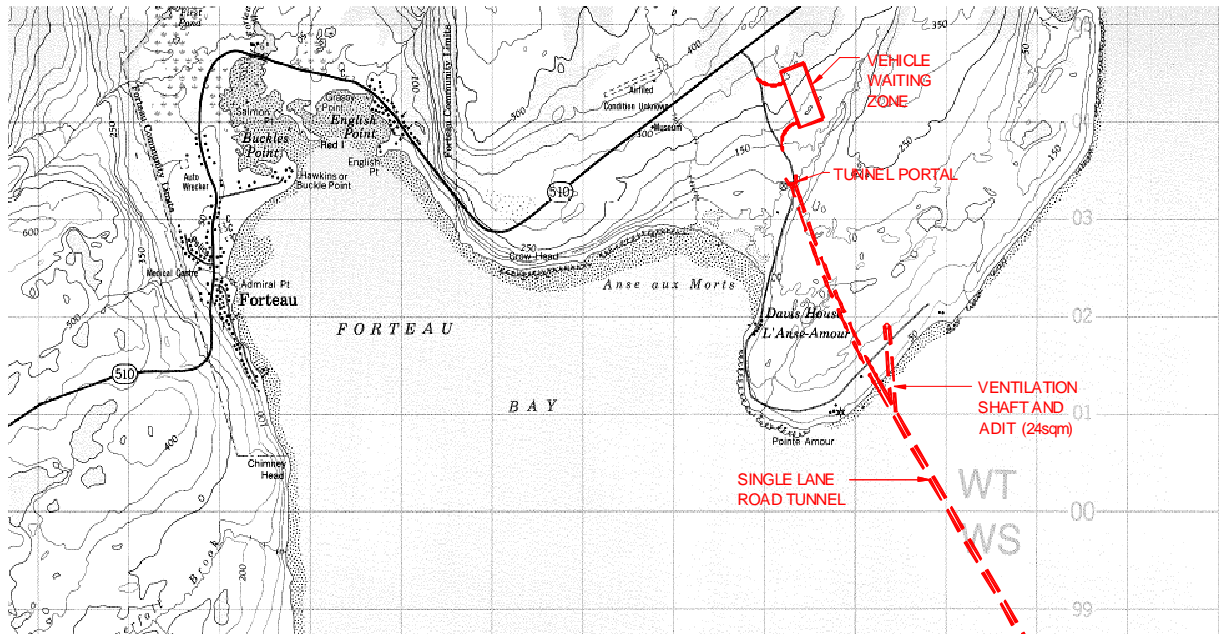
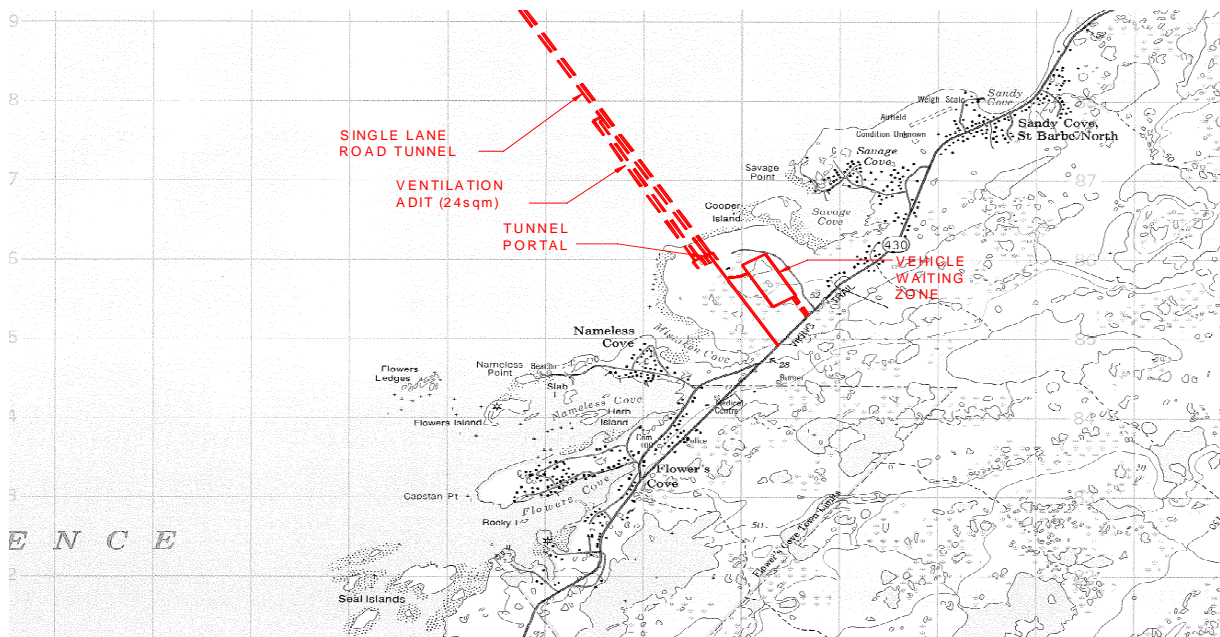

Figure 4.10 - Road Tunnel Approach Layout - Labrador Side



**Figure 4.11 – Road Tunnel Approach Layout – Newfoundland Side**

Figures 4.12 and 4.13 show conceptual layouts for the north and south approaches for the bored rail tunnel concept. These layouts show approximate tunnel portal locations, rail terminals, new roads, and points of connection to existing road systems on either side of the Strait. These layouts would be broadly similar for the drill and blast tunnel and immersed tube tunnel rail options.

The configuration for the north approach to the rail tunnel is governed by the requirement to provide a relatively flat area for siting of the north rail terminal. The only available area of this type lies to the north of English Point, and the railway tunnel swings westwards beneath Pointe Amour and Anse aux Morts and runs at an approximate grade of 1.6% to connect with this location. Assuming 4 metres of cover to the tunnel at the portal location, a 750 metres long reinforced concrete box approach structure is required to connect the tunnel to ground level.

The general topography on the south side is much flatter than on the Labrador side, and it appears that there are a number of locations where the south rail terminal could be located. For present purposes it has been sited to the east of Flower’s Cove in a location which appears to minimise the length of new road construction to connect to the rail terminal, and without apparent adverse impact on the nearby local communities around Flower’s Cove and Nameless Cove. Assuming 4 metres of cover at the tunnel portal, a 770 metres long reinforced concrete box approach structure is required to connect the tunnel to ground level.

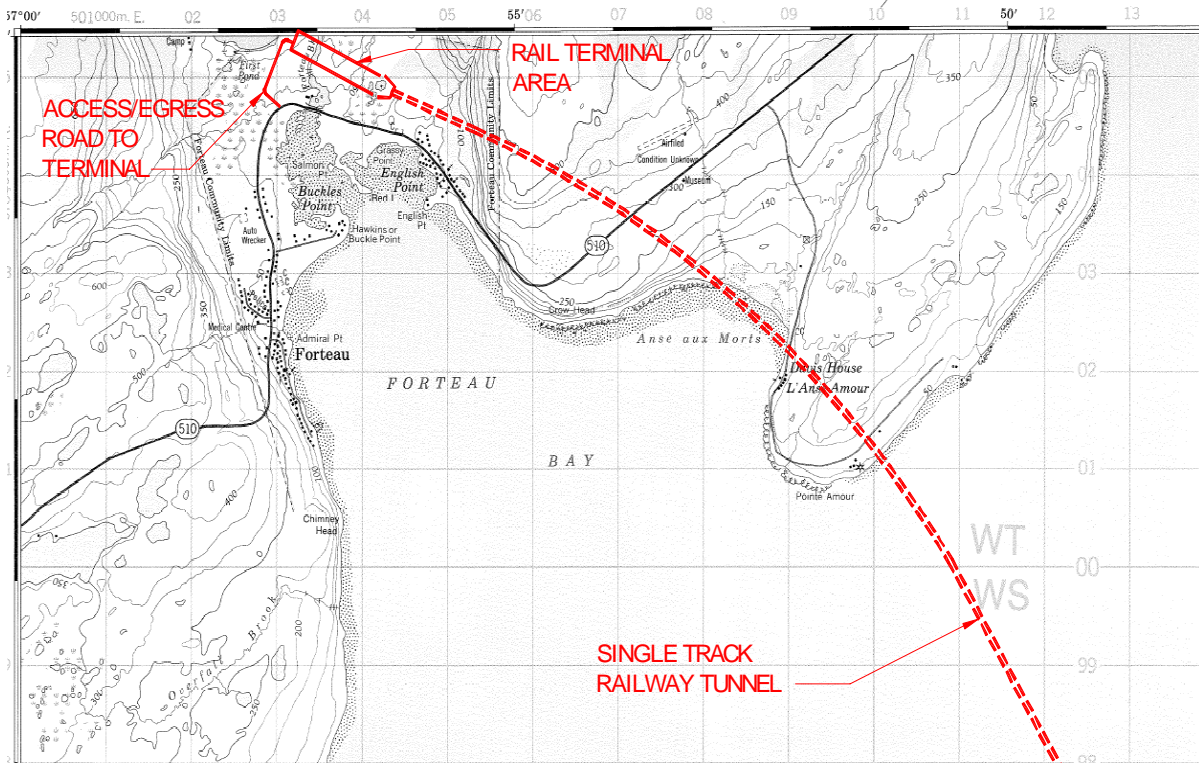

Figure 4.12 - Rail Tunnel Approach Layout- Labrador Side

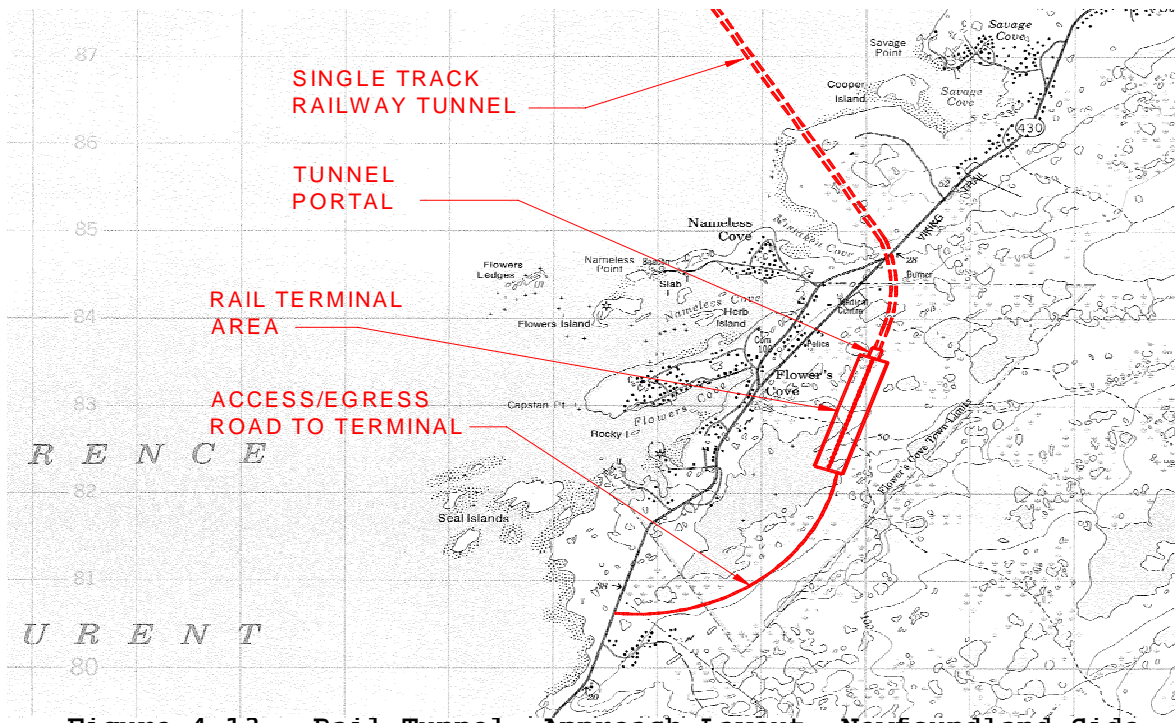

Figure 4.13 - Rail Tunnel Approach Layout- Newfoundland Side

### *Road Connections and Terminus Facilities*

The description which follows of the roads connecting to a fixed link and the required facilities at each terminus is common to all three tunnelling construction concepts. For a bridge or causeway link, it would be sufficient to connect to the existing local roads without marshalling facilities. The description supports the terminus facility concepts presented above.

The link would be accessed on the Newfoundland side from the highway along the Great Northern Peninsula and on the Labrador side from an extension of the road along the north shore of the Gulf of St. Lawrence or from the TransLabrador Highway.

On the Newfoundland side, the nearest communities to Yankee Point are Savage Cove, about 2 kilometres to the north, and Flower's Cove, about 1 kilometre to the south. Yankee Point itself is approximately 900 metres west of provincial highway Route 430 which runs north-south along the Northern Peninsula from Deer Lake to St. Anthony.

Route 430 is a paved, all-season, two-lane road and is classified as a Rural Collector Undivided (RCU 80) road with a design speed of 80 kilometres per hour. Its condition varies over its length and is rated as being in poor to good condition; some sections could be improved by simple resurfacing while others will need significant re-construction. Although some condition assessments have been done and requirements developed for upgrading work, a commitment of funding or timing for the implementation of upgrading projects has not been made. Work will be highly dependent on the availability of funding.

For a distance of 5 kilometres north and south of Yankee Point, the highest elevation of the highway is about 15 metres with a significant portion of it being below 5 metres elevation. Grades along this section of highway are fair to gentle. Horizontal alignment is very good. Traffic along this section of highway is mostly locally generated from neighboring communities; through traffic would be connecting to other communities or else would be traveling north to St. Anthony or south to the ferry terminal at St. Barbe or on to Deer Lake. A considerable amount of tourist traffic uses the road during the summer months on route to L'Anse aux Meadows and other destinations along the Viking Trail.

The terrain in this general area is characterized by coastal low lands and sloping bog plateaus. There are a considerable number of ponds in the backland, which rises gently (less than 1%) to the east to elevation 60 m at 7 kilometres from the shore.

For a road tunnel option, only 0.5 kilometre of new road construction will be needed to connect the tunnel with the existing road system. At the tunnel entrance, there will be a need for a paved marshalling area to accommodate vehicles waiting to enter the tunnel. The parking lot would be sized to accommodate the equivalent of approximately 600 passenger car units and would cover about 1.8 hectares.

For the railway tunnel option, 3 kilometres of new road will be needed to connect the rail terminal with the existing road.

On the Labrador side, Pointe Amour is reached via a 3 kilometres narrow, gravel road from Route 510; this road connects to the Trans Labrador Highway at Red Bay about 50 kilometres north, and runs another 260 kilometres further north to Cartwright. The nearest communities to Pointe Amour are Forteau, about 8 kilometres to the south, and L'Anse aux Loup, about 3 kilometres to the north.

To the south of Pointe Amour, the paved road runs 20 kilometres to the Quebec border at Blanc Sablon and then extends west into Quebec to Middle Bay for another 25 kilometres. A 40 kilometre long gravel road exists from there to Vieux Fort; its condition is not known. The nearest community along the Quebec North Shore with road access to the Quebec highway system is Natashquan, which is about 370 kilometres to the southwest. It is this distance that would require road construction to provide a continuous southern connection between the Fixed Link across the Strait of Belle Isle and points further west. Discussions with government officials in Quebec indicate that planning studies have been undertaken for this road construction. Upgrading of the 40 kilometres of existing gravel road from Middle Bay to Vieux Fort will likely be required as well.

The section of highway in the Pointe Amour area is a paved, all-season, two-lane road and is classified as a Rural Local Undivided (RLU 80) road with a design speed of 80 kilometres per hour. The condition of this road is rated as fair to good. The highway to the north of Red Bay is a new gravel road and is classified as a modified Rural Local Undivided (RLU 60).

For a distance of 5 kilometres near the Point Amour turn-off, Route 510 is at an elevation of about 100 metres while at Forteau and L'Anse aux Loup it drops below 15 metres elevation. Grades along the highway in this area are fair to steep. In terms of horizontal alignment, the road winds through the communities and is straight across country at the Pointe Amour turn-off.

Traffic along this section of highway is mostly locally generated from neighboring communities; through traffic would be connecting to other communities or else would be traveling north to the Trans Labrador Highway or south to the ferry terminal at Blanc Sablon. Tourist traffic uses the road during the summer months on route to Red Bay and other destinations along the Labrador Straits.

For the road tunnel option, 2 kilometres of new road construction will be needed to connect the existing road to the tunnel. The marshalling will be similar to that described above for the Newfoundland side. For the rail tunnel option, 1 kilometre of new road construction will be needed to connect the terminal area with the existing road.

### *Rail System Requirements*

The requirements of a rail shuttle system are as follows:

- ♦ Electric locomotives fed from a fixed overhead catenary system (OCS)
- ♦ Two flat deck cars used for loading and unloading from each end of the train
- ♦ Enclosed single level cars to hold 126 cars or 42 highway trucks (or combinations)
- ♦ Tunnel train signal system
- ♦ Loading and unloading fixed facilities
- ♦ Emergency response and maintenance vehicles
- ♦ Rolling stock maintenance facilities
- ♦ Toll collection, public and staff convenience facilities
- ♦ Operating and maintenance staff

The shuttle train consists of transfer and vehicle cars. The former are basically standard-size flat cars, typically 27.5 metres (90 ft) long with the regular timber-faced flat replaced with a durable driving surface. They weigh approximately 25 tonnes. The latter are single-level enclosed cars, with access through each end

to enable the train to be loaded by driving through from the transfer car. The configuration is based on a standard 27.5 metres bi-level auto carrier but in order to be able to accommodate a mix of trucks and cars, only a single level will be used. Bi-level cars can typically handle ten large vehicles so a single level car is assumed to accommodate six vehicles. The actual rail cars will need to be purpose-built with sufficient internal width to accommodate trucks and to enable automobiles to be driven along the length of the train by untrained drivers. All vehicles will need to be secured with tie-downs or clamps to enable operation of the train at the design speed.

Auto carriers weigh around 36 tones unloaded. The governing case for train weight will be a fully loaded tractor-trailer on a single carrier car. Truck weights in Canada vary considerably; for the purposes of this study, an average truck weight of 36 tonnes is assumed which corresponds to the US Federal highway 80,000 lb maximum. To accommodate 126 cars, each train will require 21 of these cars, and these can be arranged in 3-car or 5-car articulated “packs” with shared bogies.

Locomotives are sized for the total train weight and the performance requirements. For a 100 kilometres per hour average speed, 1.5 percent ruling grades and the friction losses associated with operating in a tunnel, the power required is 1.6 kW per tonne (2.0 bhp per ton) of train weight. Therefore nominal power requirements are 3000 kW (4000 bhp), which is well below the typical 4 to 5 MW rating of European freight locomotives. Operation of the train will require control of the locomotive from a cab on one of the flat cars, controlling the train when operating with the locomotive at the rear.

The OCS would consist of a 25 kV single phase system fed from substations at each terminal site. The catenary would be supported on 30 metres centres in the tunnel and average 55 metres spans at the terminals. For the 25 kilometres tunnel, a low profile copper conductor OCS, messenger, contact wire, and neutral wire are assumed. The OCS is fixed using overlaps at every 1600 metres and is supported at every 30 metres average using a drop tube from the ceiling and attaching a small cantilever. Neutral wire can be attached to a drop pipe. A disconnect switch will be used at each end of the tunnel. A phase break will be required in the middle of the tunnel with a disconnect switch.

At each of the terminals, approximately 2,670 track metres need to be electrified. At this stage the assumption is that a copper conductor OCS, messenger, contact wire, and neutral wire will be supported from cantilevers attached to steel wide flange poles. The poles will be mounted on cast-in-place concrete foundations. The OCS will be auto-tensioned using counterweight assemblies. Tracks will be isolated electrically using section insulators and disconnect switches. The maintenance facility will have a single wire supported at 25-meter intervals. A section insulator and a switch will be required.

At each end of the tunnel, there are facilities for loading and unloading shuttle trains. The actual configuration of these will depend upon the sites selected and the final vehicle storage capacity required. Typically they will include train storage tracks, ramps, vehicle staging area, toll booths, public restrooms, maintenance shed, etc.

### *Capital Cost Estimate*

To estimate the construction cost of a bored tunnel, the HMM tunnel estimating database (TED 2001) was used. This database has information on labour and equipment requirements and advance rates from other similar TBM bored tunnelling projects, and these are used in the development of a contractor style estimate. Where applicable, labour rates for Newfoundland were used. The cost includes the connecting roads on each



side of the Strait (but not for a highway along the north shore of the Gulf of St. Lawrence nor any upgrade of Highway 430), marshalling areas and the installation of HVDC cables.

Principal assumptions used in preparation of the estimates are as follows:

Earth pressure balance type TBM, used to mine the tunnel starting from the Island of Newfoundland side of the Strait.

Bolted precast concrete liners installed behind the TBM as it advances – these are assumed to be manufactured in the Province of Newfoundland and Labrador.

Labour conditions and wages as outlined in the collective agreement between the Construction Labour Relations Association of Newfoundland and Labrador Inc (CLRA) and LIUNA, Local 1208, Construction, Rock and Tunnel and General Workers Union, June 2003

TBM advance rates of 14 metres per day and 17.7 metres per day where rock conditions are good, for highway and railway tunnels respectively

TBM advance rates of 5.5 metres per day and 7.1 metres per day in faulted zones which are assumed to occur over a 1400 metre length of the tunnel alignment, for highway and railway tunnels respectively

8-week long learning curve at commencement of tunnelling where advance rates are 50% of those achieved when the crews are experienced.

40% contingency applied to civil elements of the work

20% contingency applied to mechanical and electrical elements of the work

15% contractor's overheads and profit applied to the estimate

17% applied to the overall estimate for design, construction management, and owner's costs.

\$15 million for feasibility study and environmental assessment

The construction cost of the road tunnel option is estimated to be \$1,559 million in 2004 dollars and the cost of the rail tunnel is estimated to be \$1144 million. A detailed cost breakdown of both estimates is provided in Appendix D.

### *Operating & Maintenance Costs*

At a pre-feasibility study level, the O&M costs will be similar for all three tunnel concepts. Expenditures associated with the operation of a road tunnel can be categorised as follows:

Management and operation of the tunnel control building

Traffic supervision costs – closed circuit television will be used for monitoring of the tunnels, with full time monitoring taking place at the surface within the tunnel control building

Emergency truck costs – these are required for the removal of broken down vehicles from the tunnel, and for carrying emergency fire fighting equipment. One emergency truck will be required at each portal, and these should be stationed close to the portals downstream of the traffic flow. Fully trained operators and an assistant will be required for each truck on a 24-hour basis.

Energy costs associated with the operation of the control centre, tunnel vehicles, tunnel ventilation equipment, and drainage pumps.

Electrical maintenance costs associated with the inspection and maintenance of the power distribution system (includes switchgear, transformers, wiring, and cabling), tunnel lighting, communication and signal systems. A platform truck is required for maintenance of the tunnel lighting system.

Mechanical maintenance costs associated with the inspection and maintenance of the tunnel ventilation system, emergency diesel generators, and drainage pumps.

Structure maintenance costs associated with the inspection, cleaning, and maintenance of the roadway, drainage sumps, and tunnel structure. A street cleaner vehicle is required for cleaning of the roadway, and a washing truck for frequent cleaning of the tunnel walls and soffit.

Estimated operating and maintenance cost for the highway tunnel option are \$6.8 million per annum in 2004 dollars. Appendix E provides a breakdown of these costs.

Expenditure associated with the operation of a rail tunnel can be categorized as follows:

Energy costs associated with the operation of tunnel lighting, equipment, and drainage pumps - the majority of these costs will be for the supply of electrical power and will therefore vary with fluctuations in market costs for electricity

Electrical maintenance costs associated with the inspection and maintenance of the power distribution system (includes switchgear, transformers, wiring, and cabling), tunnel lighting, communication and signal systems

Mechanical maintenance costs associated with the inspection and maintenance of the tunnel ventilation system, emergency diesel generators, and drainage pumps

Structure maintenance costs associated with the inspection, cleaning and maintenance of the permanent way, drainage sumps, and tunnel structure

For tunnelling projects, it is typical for contingencies at a pre-feasibility stage to range from 40% to 75%. The selection of contingency level is particularly related to the existence or lack of geotechnical investigation. Typically at this stage no investigation has taken place. For this project, a contingency of 40% has been chosen for the tunnel (civil) costs since a conceptual geotechnical investigation has taken place, several years earlier, and therefore the lower end of the range of contingency levels can be used.

Estimated operating costs for the rail tunnel alone are \$0.9 million per annum in 2004 dollars. The estimated operating costs for the train shuttle are \$6.74 million for a total of \$7.64 million. Appendix F provides a breakdown of these costs.

**Construction Schedule**

A major factor in the schedule for a bored tunnelling operation is the procurement of the TBM and manufacture and supply of precast concrete lining rings in advance of commencement of tunnelling operations. Experience on other major projects has demonstrated that TBM procurement / manufacture can normally take up to 15 months, and such a period has therefore been allowed for the scheduling of the TBM tunnel options.

The schedule for construction of the road tunnel option is shown in Figure 4.14. The estimated duration from project commencement is 146 months, assuming 36 months for planning activities and 24 months for tunnel design. This schedule assumes that the tunnelling work is undertaken by a single TBM operating from the Newfoundland side.

The schedule for construction of the railway option is similar to that for the road tunnel with an additional 4months because the tunnel is longer to account for the lower grades on the approaches. Using a single TBM results in an overall construction schedule of 150 months.

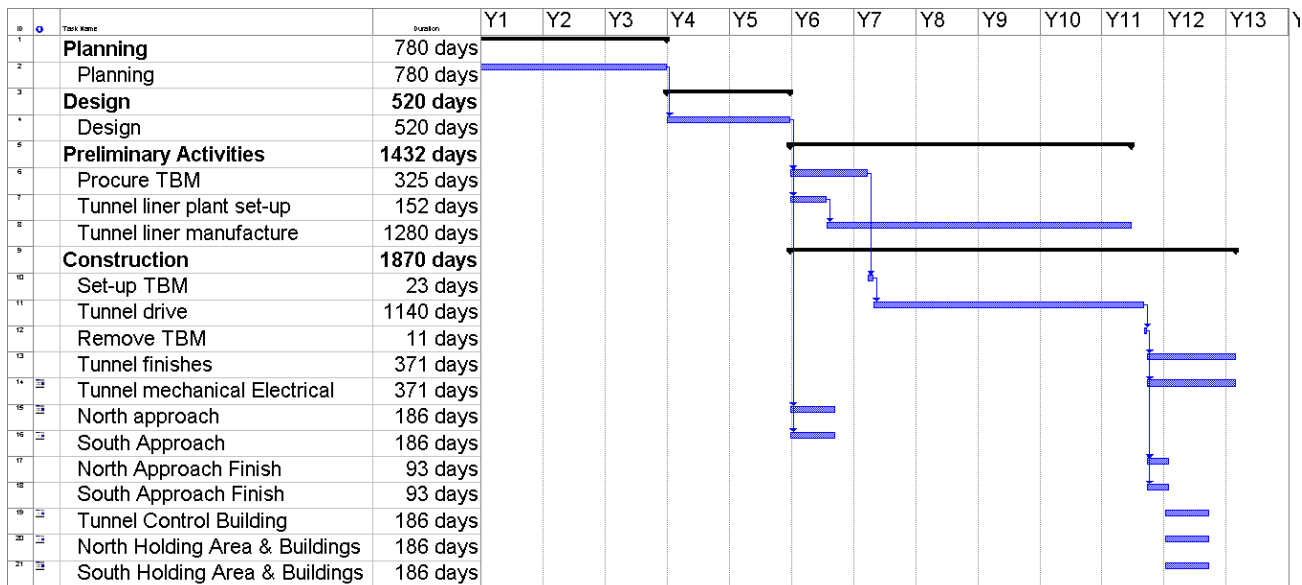

**Figure 4.14 - TBM Bored Road Tunnel Construction Schedule (1 TBM)**

**4.3.2 Drill and Blast**

A drill & blast tunnel would be located in the sedimentary layer at a depth below the seabed level of approximately 60 metres between the seabed and the crown of the tunnel. Unlike the TBM bored tunnel option, it is considered inadvisable to locate the drill & blast tunnel only one tunnel depth below the seabed since the drill and blast technique does not provide immediate support or against water pressure, and blasting operations could open up a previously undiscovered zone of weak or faulted rock with serious consequences for the tunnel construction. The drill & blast tunnel options are therefore 0.3 kilometre and 4.4 kilometres longer than the respective road and rail tunnels constructed using TBM.

Even with the lowered alignment, tunnelling using drill and blast techniques must include measures to reduce the risk of major water inflows into the tunnel. These measures would typically consist of drilling probe holes ahead of the excavation (usually about 30 or 40 metres ahead) to detect potential inflows. Should an inflow be detected, then a series of additional holes are drilled to allow pumping of pressurized cement grout into the rock joints and pressures and into zones of broken rock, ahead of the excavation face. This process can require repeated operation before the inflow is reduced to an acceptable level. The grouting may have to deal with hydrostatic pressures of up to 17 atmospheres. This is not considered a problem. (HMM is presently managing such a grouting program in a tunnel in California where hydrostatic pressures are 30 atmospheres).

The cost estimate and schedule allow for full coverage in terms of maintaining a probe hole drilled ahead of the excavation face and for grouting of 10% of the length of the tunnel. As might be expected this amount of grouting has a significant negative effect on the overall advance rate for the tunnel.

There will likely be some degree of seepage at all times and a cast-in-place concrete liner would have to be installed within the tunnel on completion of drill & blast operations. Collapsible travelling steel forms are generally used for forming such liners with concrete transported to the required location by means of pipeline or agitator cars that prevent early setting of the concrete prior to placement.

For drill & blast operations, excavated material can be removed from the tunnel by means of locomotive and muck cars, or by rubber tired trucks, which travel between the tunnel face and the surface. Because of likely ventilation problems in such a long tunnel, the former method would likely be required. Profiles for the road and rail tunnel concepts are shown in Figures 4.15 and 4.16 respectively.

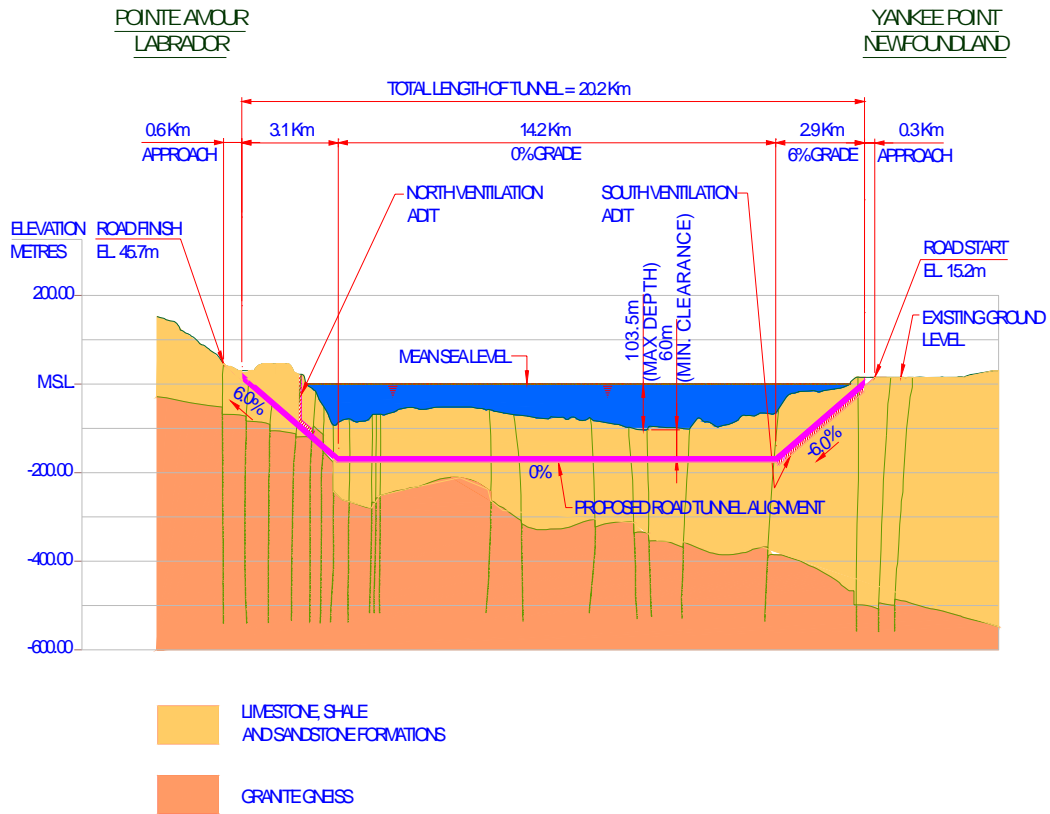
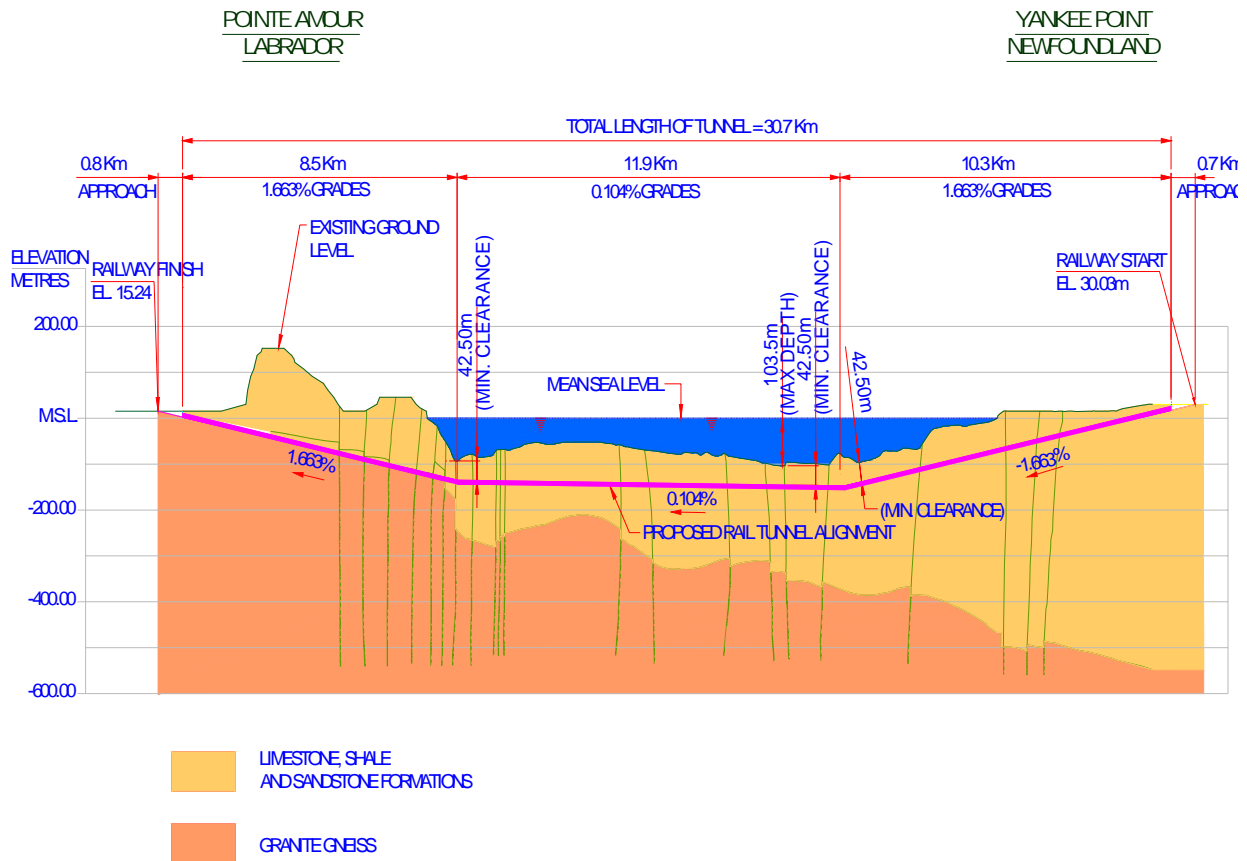

Figure 4.15 - Drill & Blast Road Tunnel Conceptual Profile



**Figure 4.16 - Drill & Blast Rail Tunnel Conceptual Profile**

Figures 4.17 and 4.18 show the conceptual cross-sections for the drill and blast road tunnel. The first shows a cross-section with no space provided for ventilation ducts; this section would apply to ventilation zone 3 where ventilation ducts are not required. The second shows a cross-section with approximately 24 m<sup>2</sup> of duct space, which satisfies the requirements of zones 2 and 4. However, this cross-section would also be constructed within ventilation zones 1 and 5 with additional separate and adjacent ventilation adits to make up the 24 m<sup>2</sup> shortfall in duct space. Figure 4.19 shows the conceptual cross-section for the rail tunnel.

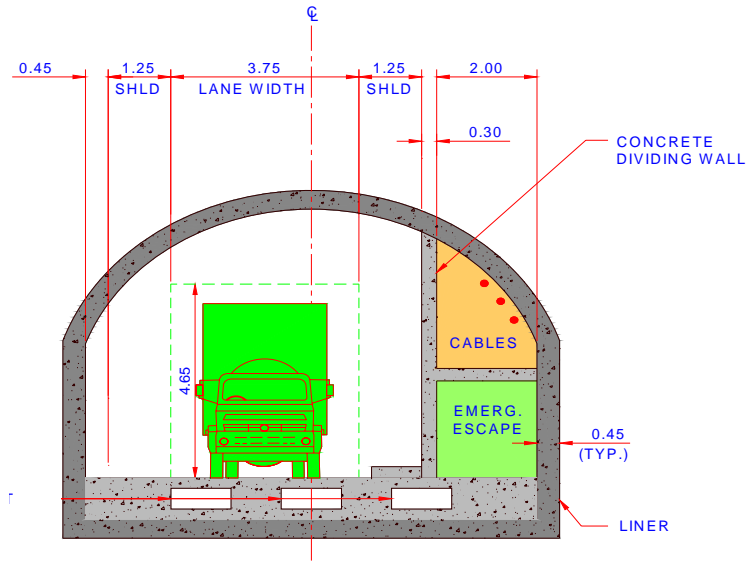

Figure 4.17 - Drill & Blast Road Tunnel Cross Section-Ventilation Zone 3

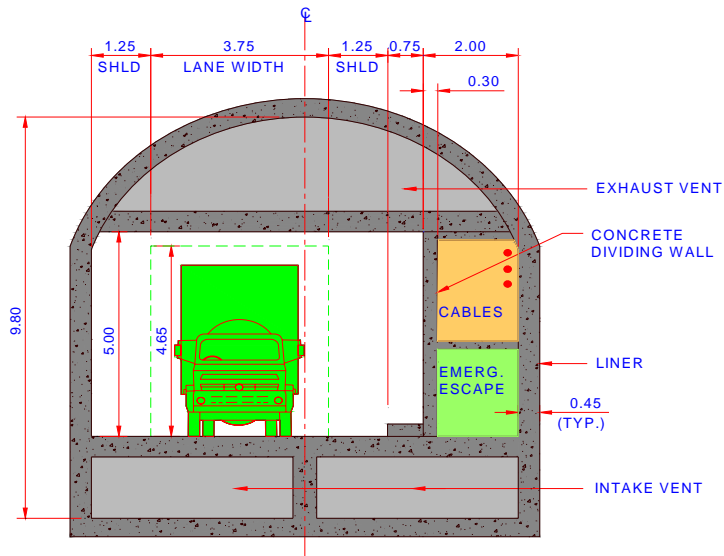
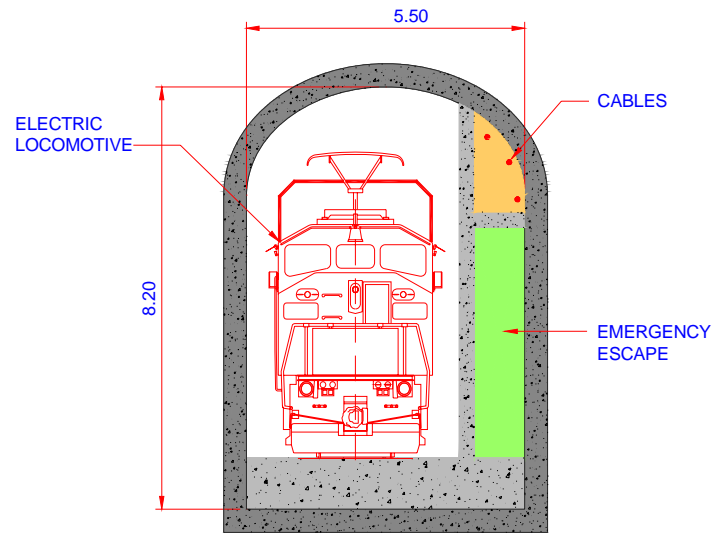

Figure 4.18 - Drill & Blast Road Tunnel Cross-section -Ventilation Zones 1, 2, 4, and 5



**Figure 4.19 - Drill and Blast Rail Tunnel Cross-section**

### *Capital Cost Estimate*

The principal assumptions used in preparation of the drill & blast tunnelling estimates are as follows:

Tunnel driven from both sides of the Strait simultaneously

Labour conditions and wages as outlined in the Newfoundland labour agreement 2003, as noted previously

Average drill & blast advance rate of 3.2 metres per day and 3.0 metres per day for road and rail tunnels respectively

40% of tunnel length requires crown rockbolts and wiremesh only for primary support

50% of tunnel length requires full pattern rockbolts, wiremesh, and 50mm thickness of shotcrete for primary support

10% of tunnel length requires steel sets and 100 mm thickness of shotcrete for primary support

10% of tunnel requires grouting

Cast-in-place final liner installed in tunnel on completion of drill & blast operations

100% probing ahead

40% contingency applied to civil elements of the work

20% contingency applied to mechanical and electrical elements of the work

15% Contractor's overheads and profit applied



17% applied to the overall estimate for design, construction management and owner’s costs

\$15 million allowed for feasibility study and environmental assessment

For tunnelling projects, it is typical for contingencies at a pre-feasibility stage to range from 40% to 75%. The selection of contingency level is particularly related to the existence or lack of geotechnical investigation. Typically at this stage no investigation has taken place. For this project, a contingency of 40% has been chosen for the tunnel (civil) costs since a conceptual geotechnical investigation has taken place, several years earlier, and therefore the lower end of the range of contingency levels can be used.

The construction cost of the road tunnel option is estimated to be \$1,800 million in 2004 dollars. This figure includes ventilation equipment, lighting, sumps and pumping, tunnel approaches, and vehicle waiting areas on both sides of the Strait. The cost of the rail tunnel is estimated to be \$2,272 million in 2004 dollars. This figure includes the full cost of the electric rail shuttle system in addition to the other items. A detailed cost breakdown for both options is provided in Appendix D.

*Schedule*

The schedule for drill and blast construction is based on a typical advance rate for this type of construction and for the fact that this method will be greatly affected by the need to reduce water inflows during construction. For long tunnels, it is now typical that drill and blast techniques are not used because of their very slow progress rate compared to tunnel boring machines.

The drill & blast tunnelling operations would be undertaken from both sides of the Strait. The schedule for the road tunnel as shown in Figure 4.20 is 214 months from project commencement, assuming 24 months for tunnel design. The schedule for the rail option is 286 months because of the additional length.

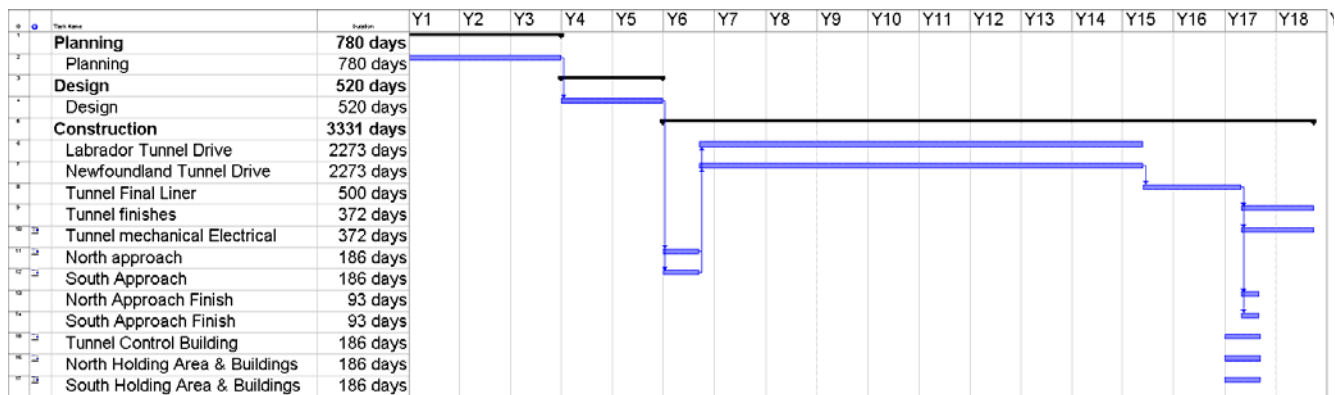

**Figure 4.20 - Drill & Blast Road Tunnel Schedule**

*4.3.3 Immersed Tube Tunnel (ITT)*

An ITT can be simply described as a series of connected and sealed pre-fabricated tunnel units within a pre-dredged trench in the seabed. The tunnel units are floated to their required location and sunk to their final position, an operation which requires a great deal of care and precision. Special seals are used between

adjacent tunnel units to ensure construction of a watertight tunnel. Once the tunnel units are in position, the trench is backfilled to form the ITT. Three main alternatives exist for construction of an ITT:

- *Reinforced Concrete Tunnel Construction* – rectangular shaped reinforced concrete units
- *Steel Shell Tunnel Construction* – cylindrical steel shell units
- *Composite (SCS)* – approximately rectangular steel units with concrete on the inside

Each of these methods has distinct advantages and disadvantages in relation to the other, and for details of these the reader is referred to the detailed description of the ITT option provided in Appendix C. For current conceptual cost estimating and scheduling purposes, it has been assumed that reinforced concrete tunnel construction is the optimum means of undertaking the work largely because the construction industry in Newfoundland is likely to be most suited to this type of ITT unit construction. Several locations in the Province should be suitable for such fabrication including those that have been used in the offshore oil industry. It is also possible that a new site could be developed close to the tunnel construction sites to minimize towing distance. To create a suitable site, a small inlet could be dammed off to create a dry dock (similar to Bull Arm/Great Mosquito Cove but on a smaller scale). Ultimately such a decision would rest with the contractor.

As noted in the discussion of other link concepts, there are very significant risks associated with the construction of an ITT in the Strait of Belle Isle. The concept has similar risks to those discussed for the bridge and causeway concepts in that the construction would be in a hostile environment in deep water containing sea ice and icebergs. In addition, in the case of an ITT, there are construction risks associated with the excavation in bedrock in deep water (in the case of placing the ITT in a deep trench to avoid iceberg scour) at large water depths. Furthermore, there is the risk associated with the design of the depth of burial in overburden to avoid scour or the design of sufficient protection works to absorb iceberg impact if the ITT is not buried in a ditch.

Although many comparable studies for ITT crossings with similar complexities have been conducted in the recent past – such as a 19 kilometres long ITT alternative for the crossing of the English Channel and an 85 kilometre long crossing of the Bering Strait, the construction of an ITT of the magnitude of the proposed crossing has never been attempted. At present, the world's longest immersed tube tunnel is the Bay Area Rapid Transit Tunnel in Oakland, California, which is 5.8 kilometres long in a maximum water depth of 40.5 metres and which opened in 1970. In the relatively near future, a deeper ITT will be constructed across the Bosphorus Channel although at 60 metres the depth of this crossing will not approach the depths required for an ITT crossing of the Strait of Belle Isle.

Section 3 of this report described the surficial and bedrock geology for the proposed crossing between Pointe Amour and Yankee Point. Borings from the 1981 drilling program indicate that the seabed overburden consists of thin deposits of shells, sand, gravel, glaciomarine marine deposits and dense till. Along the proposed route, the average overburden thickness, including till, is 2.5 to 3.0 metres. Two of the borings, A1 and B4, did not however reach the bedrock and encountered either the glaciomarine marine deposits or tills to full depth. The maximum thickness of these surficial deposits is not known and estimates vary depending upon the source. It does however seem likely that depths will exceed 5 metres, and perhaps reach 10-12 metres in localized depressions. The maximum drilled depth to bedrock below the seabed in this investigation was 3.69 metres with an average depth of 2.5 metres. The bedrock consisted primarily of limestone and shale, with some sandstone, and is generally described as dense and fresh.

Based on the soil test results provided from these borings, the slope angles shown in Table 4.1 were adopted for the purposes of estimating the cost of ITT construction.

**Table 4.1: Estimated Stable Slope Angles for the Soil and Rock Strata**

<b>Overburden unit/Bedrock Formation</b>	<b>Estimated Slope angle for a stable slope based on an submerged infinite slope analysis</b>
Sand, Shells & Gravel	1 vertical to 2 horizontal
Glaciomarine – Marine Deposits	1 vertical to 4 horizontal
Glacial Till	1 vertical to 3 horizontal
Sedimentary Rock Strata	5 vertical to 1 horizontal

Figures 4.21 and 4.22 show conceptual profiles for road and rail ITT options respectively. Both profiles assume that the ITT is located within a pre-excavated trench in the seabed with 6% approach grades for the road tunnel and 1.8 % grades for the rail tunnel. The trench in bedrock is excavated to a depth nominally greater than the height of the ITT unit since scour in bedrock is not a factor, and to a depth of approximately 14 metres in overburden to allow for 5.5 metres of material on top of the units to accommodate iceberg scour.

For excavation of the ITT trench, it is anticipated that the soft ground overburden will be removed using clamshell or hydraulic equipment without need for pre-treatment. Up to depths of about 40 m, normal clamshell grabs will be suitable, while remotely operated vessel (ROV) steered clamshell grabs will be required elsewhere. Such ROV's have been successfully used in water depths exceeding 100 metres but not for this purpose.

Excavation of the underlying limestone and sandstone layers is likely to be more problematic and blasting or submersible excavation equipment may be required. Blasting in water depths of 100 metres is rare; in recent years tracked land-based construction machines have been developed to operate in water depths of over 100 m. Such machines are likely to be necessary for deeper sections of the ITT alignment.

The presence of sea ice will have a significant effect on dredging operations, and it is anticipated that dredging will only be possible for about 7 months of the year. It is also probable that redredging of the trench will be required prior to placement of the tunnel units, as previous investigations suggest that the bottom currents are capable of moving sediments. For cost estimating purposes, an allowance of 15% of the original total excavation has been assumed.

ITT construction techniques would be used only for undersea sections of the alignment, and more conventional open cut, drill & blast tunnelling, or TBM bored tunnelling would be employed for underland sections of the alignment. Specialized construction methods are required at the land/sea interface zones to prevent flooding of the immersed tube. These methods will vary from location to location, depending on seabed depths and profiles and the construction methods adopted for the landward sections.

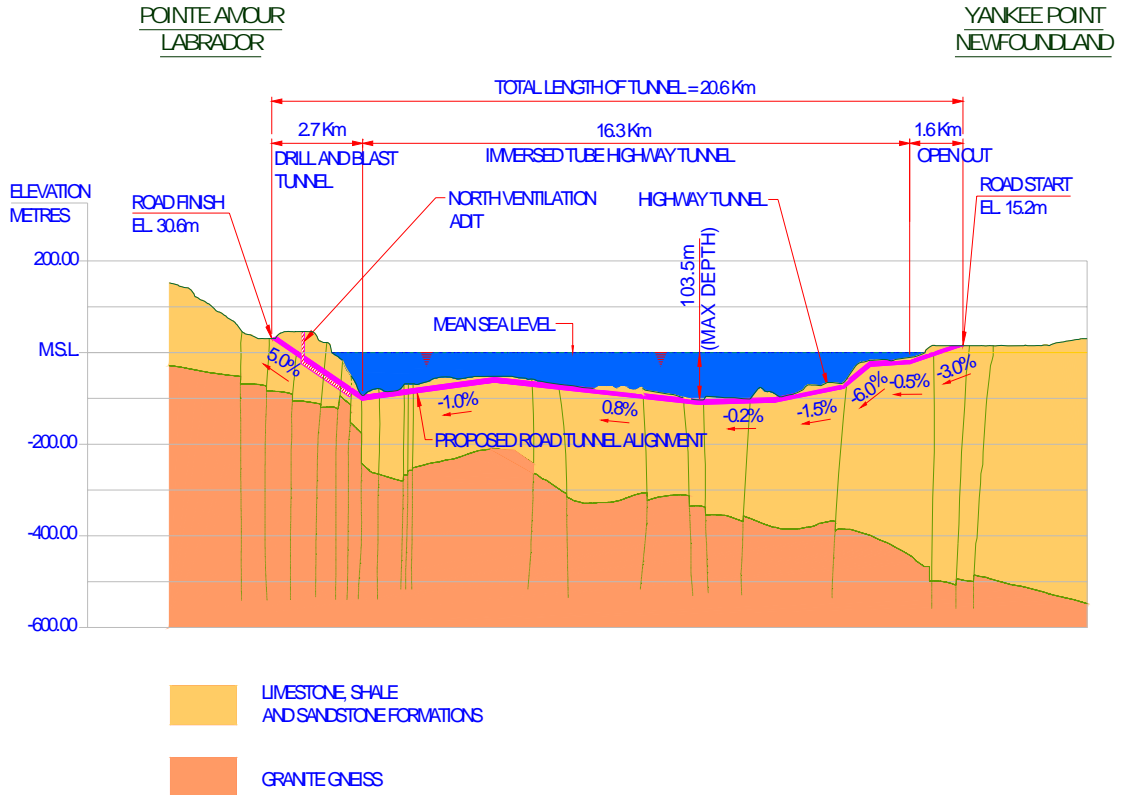

Figure 4.21 - Immersed Tube Road Tunnel Conceptual Profile

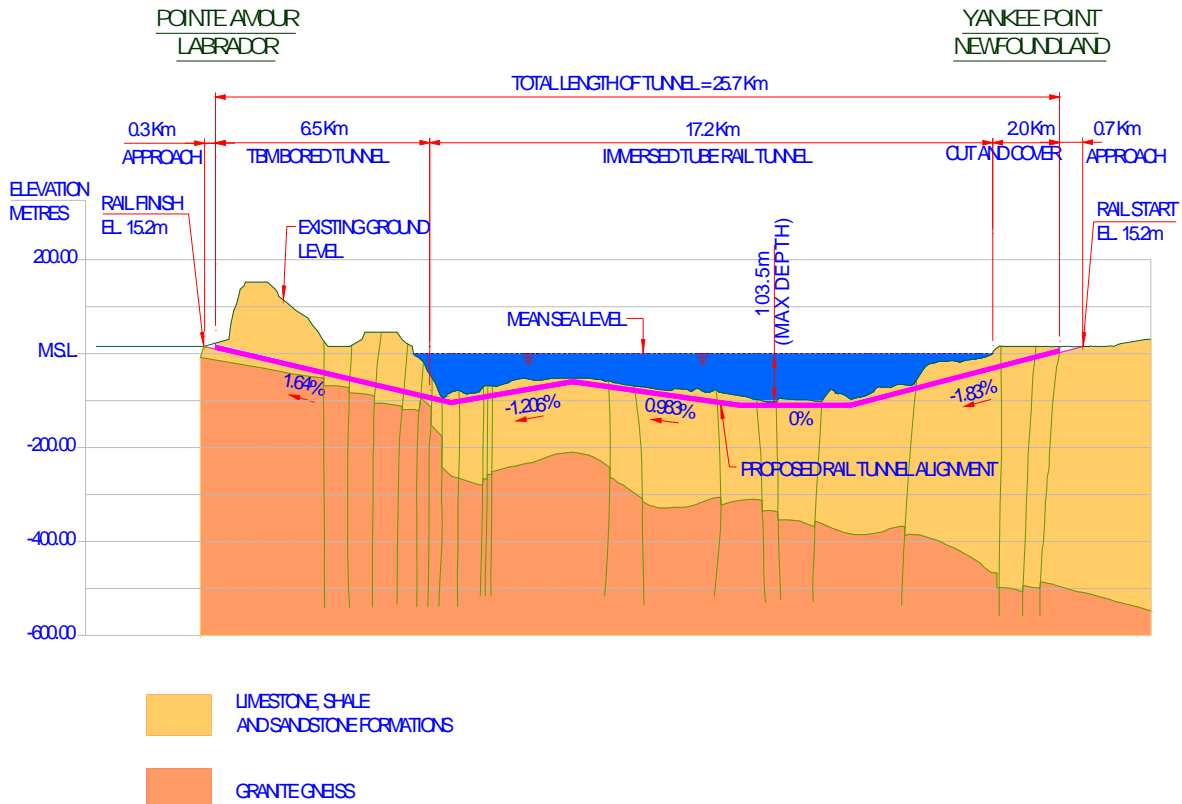

Figure 4.22 - Immersed Tube Rail Tunnel Conceptual Profile

Three cross-sections reflecting different ventilation zones for the road ITT are shown in Figures 4.23, 4.24 and 4.25 and a single section for the rail ITT is shown in Figure 4.26.

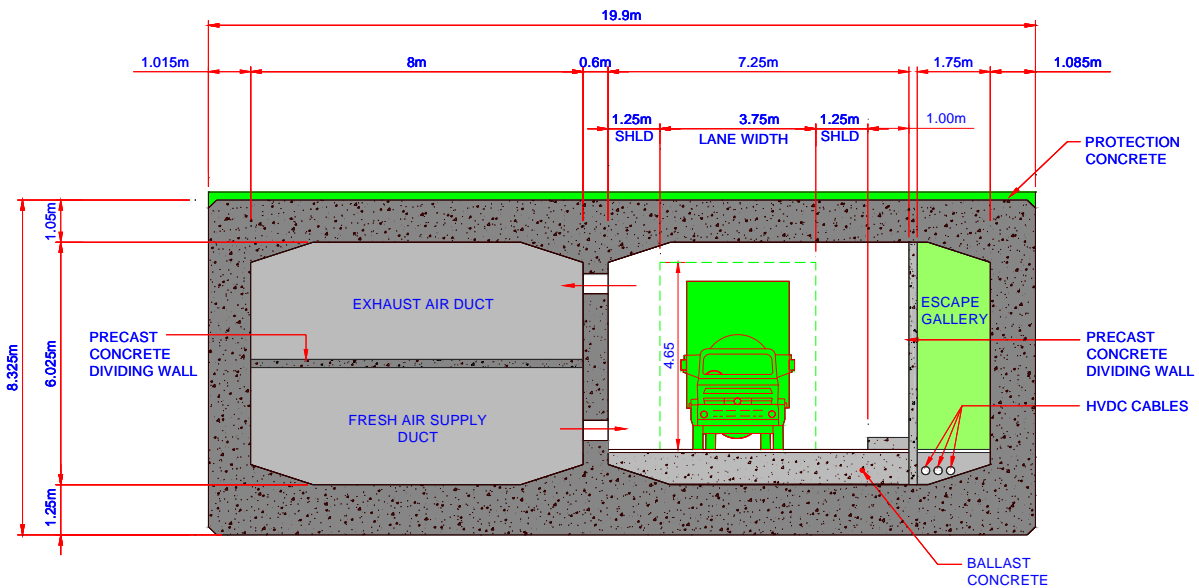

Figure 4.23 - ITT Road Tunnel Cross-section for Ventilation Zone 1

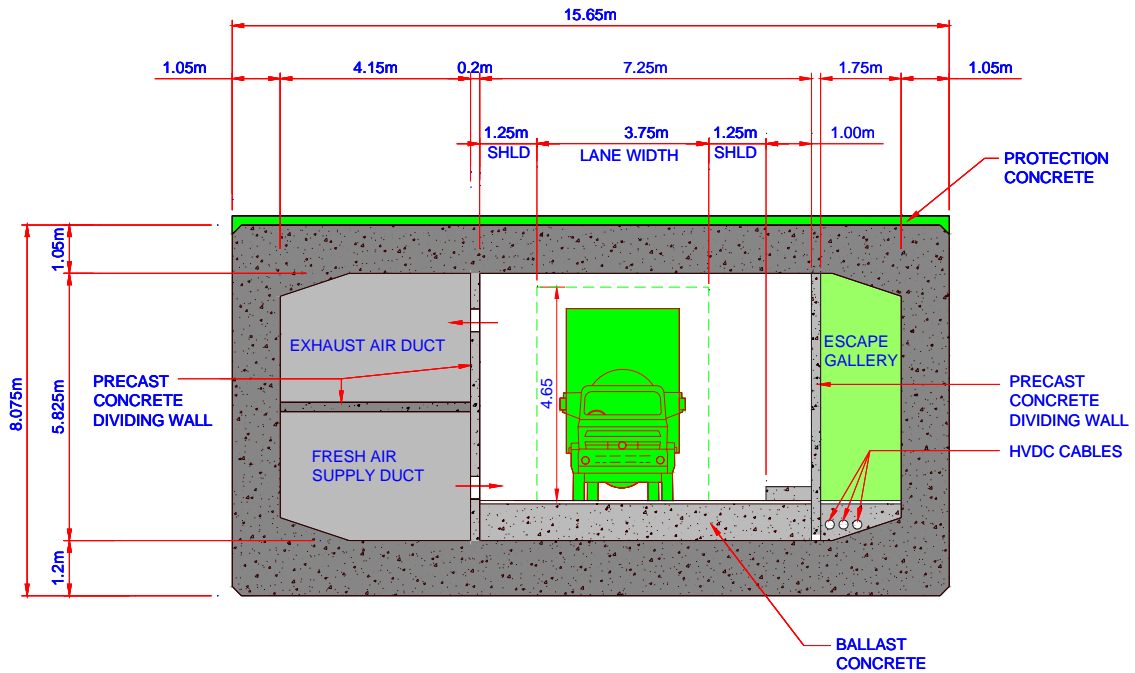

Figure 4.24 - ITT Road Tunnel Cross-section for Ventilation Zone 2

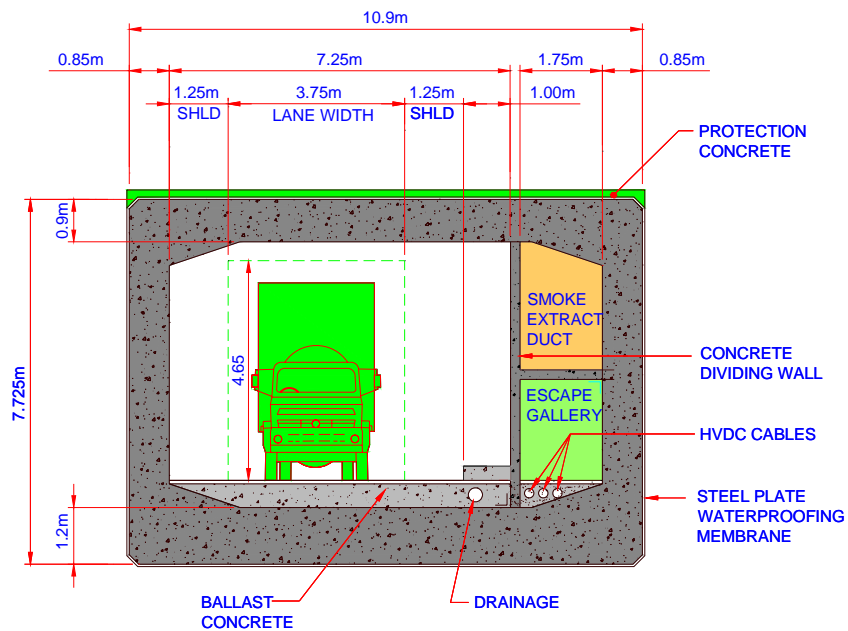

Figure 4.25 - ITT Road Tunnel Cross-section for Ventilation Zone 3

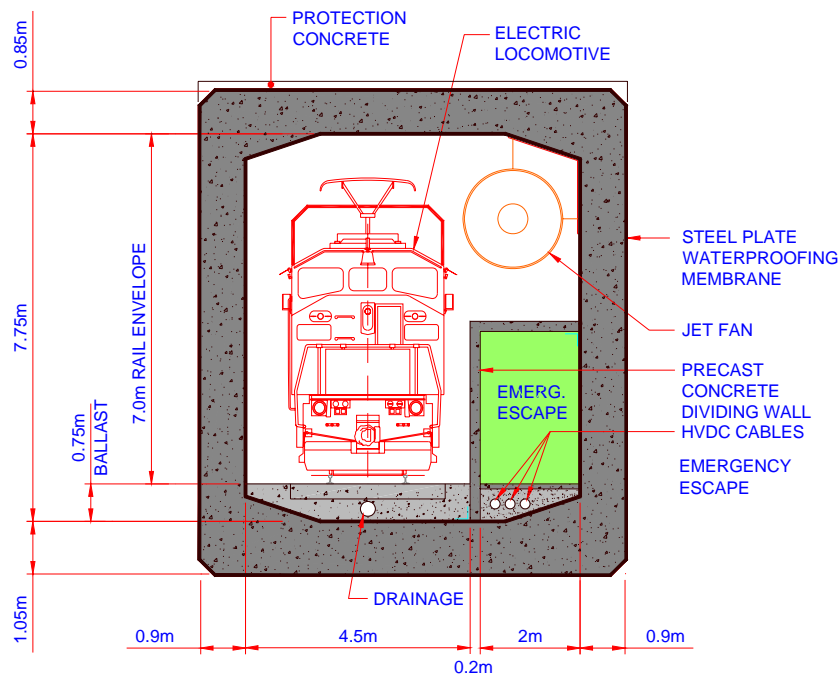

Figure 4.26 - ITT Rail Tunnel Cross-section

### Capital Cost Estimate

In developing the cost estimate, multiple sources of information have been used including:

- Bull Arm Site Corporation for lease costs for drydock, batching plant, reinforcement shop and the deep-water storage site.
- Newfoundland Heavy Construction Cost database for principal quantities including cast-in-place and precast concrete, formwork, reinforcement, structural steel, surfacing etc.
- historic information for tunnel joint prices for the special seals between ITT units, escalated to 2004 prices, with applied contingency for anticipated larger seal requirements.
- rates for dredging, and backfilling for the tunnel based upon discussions with multiple dredging contractors.
- remobilization costs which will be incurred each dredging season due to sea ice induced shutdown

As stated earlier, the costs of the ITT have been developed based on the use of concrete tunnel technology. To derive basic tunnel quantities, in conjunction with the proposed traffic clearance envelopes and stipulated ventilation requirements, minimum factors of safety for the ITT sections while afloat and in-place were assumed, which allowed the development of concrete member sizes. The only figure which has been specifically modified for this project is that of reinforcement. Concrete ITT's at normal depth will typically have a reinforcement density in the region of  $110 \text{ kg/m}^3$ . For cost estimating purposes, far higher reinforcement densities have been assumed, to reflect the higher imposed loadings due to the deeper submergence in the present case.

For the dredged trench, representative sections were developed, with variations in the depth of the overburden or surficial deposits, which as mentioned, have an average thickness of between 2.5 and 3 m. The deposits themselves vary from the relatively weak and unstable glaciomarine - marine deposits to the much more stable sands, gravels, and tills. Correspondingly, the weaker soils will be cut back at shallower angles to maintain trench stability.

Sections were developed for each of the tunnel geometry options, providing high-end and low-end dredge quantities by varying the overburden geology and thickness. Side slope angles were in accordance with the recommendations made previously. The two extreme values were averaged to obtain the quantity estimate. At the same time this approach provided an indication of the influence that overburden variations could have on the quantities and hence costs. It is conceivable that within a certain area, the cross-sectional area of the trench could be significantly higher or lower than predicted. However until the surficial deposits are investigated further, and their limits more accurately defined, this “averaging” approach is considered the most appropriate.

An alternative to constructing an immersed tube tunnel (ITT) in a ditch of sufficient depth to avoid iceberg scour is to lay it on the prepared seabed with minimal excavation and protect it from icebergs by using a rock protection berm, which would be sufficiently robust to absorb iceberg impact, in a manner similar to the causeway concept. There is a level of risk associated with such a concept both in the construction and operational phases. During construction, the risk would be to cost relating to schedule delays, whereas during operation, there could be a human as well as a financial risk. These types of risks may be minimized to an acceptable level by implementing an iceberg management program as referred to previously. During construction, icebergs could be towed or construction halted until the hazard has passed. During operation, the tunnel could be temporarily closed if the hazard is deemed high enough.

The interaction dynamics of an iceberg with a rock berm and the subsequent mechanism through which the energy of the iceberg is dissipated are speculative, in the absence of any actual observations, modeling or detailed analytical assessments. For the purposes of the current exercise, however, some reasonable assumptions of these processes may be made. The energy of the iceberg would be dissipated through contact with, and possible displacement of, rock elements, compression of the rockfill, crushing of the iceberg over the contact area, or a combination of these processes. There is also some evidence to suggest that, given a sufficiently shallow slope, the iceberg may ride up or roll over the berm. While a shallow slope is desirable in terms of slowing the iceberg with little or no penetration into the berm, it does present the possibility that through rolling, the iceberg may exert loads on the top of the immersed tube from transmission of forces through the rockfill on top of the tunnel. Such a possibility determines the depth and characteristics of the protection works on top of the tunnel.

For present purposes to provide a rough estimate of the cost of protection, the depth of the rock cover over the railway tunnel is assumed to be 4 metres and the slope is 1:5 to encourage loss of energy due to sliding contact. It is unlikely that the depth of cover would be any less than this, and therefore the associated costs may be considered a minimum for this depth and slope. The resulting volume of rock in the berm is 17.38 million m<sup>3</sup> and the cost at \$100 per m<sup>3</sup> in place (for nominal 1 metre stone) would be \$1738 million. If subsequent analysis showed that the slope could be increased to 1:1.8 (similar to that used in the causeway rockfill berms) without undue loads being exerted on the tunnel, the cost for protection would be reduced to \$665 million, which is still more expensive than the dredging and backfilling costs of \$430 million required to locate the railway ITT within an excavated trench without a protective berm.



The construction cost of the road ITT option is estimated to be \$4,810 million in 2004 dollars. This figure includes ventilation equipment, lighting, sumps and pumping, tunnel approaches, and vehicle waiting areas on either side of the Strait. The construction cost of the rail ITT is estimated to be \$2,814 million. This figure also includes cost of the electric rail shuttle system. A detailed breakdown of the estimates for both options is provided in Appendix D.

Principal assumptions used in preparation of the above estimates are as follows:

- ♦ 40% contingency applied to civil elements of the work
- ♦ 20% contingency applied to mechanical and electrical elements of the work
- ♦ 15% contractor's overheads and profits applied to the estimate
- ♦ \$15 million for feasibility study and environmental assessment
- ♦ 17% for engineering and project management

### *Schedule*

The major critical path items for the development of a schedule for the ITT construction are:

- ♦ Dredging of the trench
- ♦ Fabrication of the tunnel elements
- ♦ Placement of the tunnel elements

The tunnel placement operation has been used as the basis for deriving the tunnel construction duration. The Strait is accessible in the months of June to December, typically comprising a period of approximately 30 weeks. It has been assumed that in these months, tunnel elements will be placed approximately at the rate of one per week. However, provision should be made within this schedule for factors such as the required tow length from identified facilities, inclement weather, including prolonged winter, and icebergs. For these reasons we have assumed that 25 elements will be placed per season. This remains a demanding figure for one season of construction.

Other assumptions include:

Sufficient dredging must be performed each season to accommodate placement of 25 elements. The dredging operation will be continuous, 24 hours per day, 7 days per week. It is also assumed that multiple dredgers will be in operation at any given time.

Similarly, suitable fabrication facilities can be leased or constructed, and sufficient skilled labor can be identified to accommodate the construction of 25 elements per year. Due to the size of the project, the potential exists for more than one fabrication facility to be engaged. It is assumed that sufficient facilities can be available to meet the recommended production requirement.

A tunnel element length of 150 metres has been assumed. This is longer than average, but within current technological limits. The longest concrete elements to date, for the Oresund Tunnel, measured 175 m, and the longest steel plated elements measured 135 metres approximately. The 150-m length is a usable figure on the basis that further study would be necessary to fully define a preferred construction method.

It is assumed that Newfoundland will provide the majority of the fabrication facilities, and will be the primary source of labour for the project. Therefore, it is assumed that the construction of the Newfoundland approach could proceed more rapidly, and be available sooner to interface with the ITT. Subsequently, placement of tunnel elements will proceed from the Newfoundland side, enabling internal concrete works to begin from this location.

Internal fitting-out of the tunnel can continue year-round providing that three bulkheads are maintained between this work and newly installed units.

Internal concreting of the tunnel sections, including emergency corridor, and roadway ballast or track slab, will proceed after placement of several elements.

Figure 4.27 provides a schedule for construction of the road ITT option. The estimated duration from project commencement is 176 months, assuming 36 months for planning activities and 24 months for tunnel design. The schedule for construction of the rail option is similar but 4 months longer.

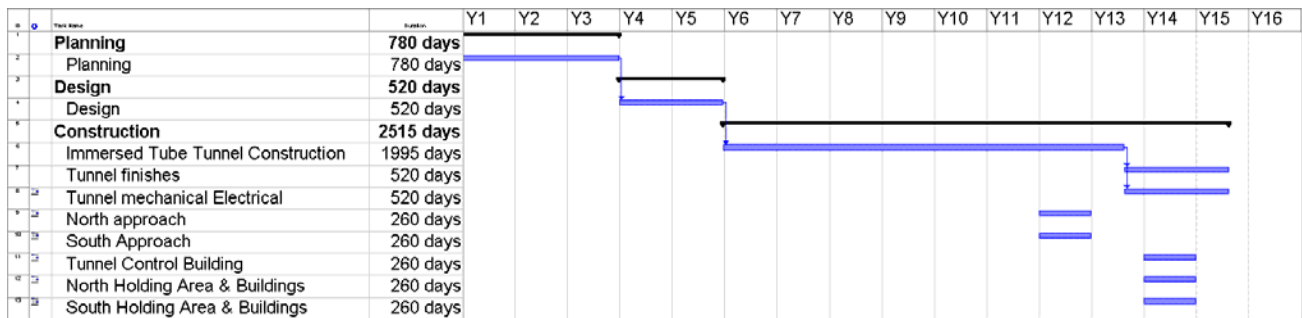

Figure 4.27 - Road ITT Schedule

#### 4.4 Comparison of Alternatives

##### Risk Assessment

In comparing the link alternatives it is important to address the risks associated with them. These risks can be divided into two major categories; short term risks associated with the construction and long term risks related to the operation of the facility. These risks have been already referred to in the respective descriptions of the alternatives and are, for the most part, repeated here for the sake of completeness.

##### Construction Risks

###### Bridge

For the bridge construction several conditions at the site present unusual levels of risk. Included in these would be:

- ♦ Heavily travelled navigation channel
- ♦ Icebergs

- Difficult sea ice conditions during the winter period that would likely prevent marine based construction during this period
- Significant water depths, approaching 100 m, with potentially heavy seas and strong currents presenting difficulties in constructing foundations for piers and placing protection works.

These risks, combined, present a high level of risk that the construction would be interrupted and the schedule extended with consequent increases in cost.

#### *Causeway*

The causeway, being constructed within the marine environment is exposed to the same conditions as the bridge. The causeway itself would be less sensitive to these conditions but the bridge component would have the same problems as the all-bridge concept. Overall, this concept would have a lower level of construction risk than the all-bridge concept.

#### *Bored Tunnel*

The bored tunnel constructed by tunnel boring machine is not exposed to the hostile environmental conditions facing the bridge and causeway options. The construction risks for this option relate to the inherent risks associated with tunnelling. These risks are related to geotechnical conditions, particularly to the presence of faults or fractured rock requiring immediate support and to the presence of water inflows.

The selection of an earth pressure balance tunnel boring machine together with a precast concrete tunnel lining substantially reduces the risks presented by the geotechnical conditions. This type of machine seals off the workers from exposure to the ground conditions and to associated water inflows. The construction risks that remain relate to the appropriate operation of the machine and to its maintenance. For the operation, there are many ways of monitoring machine functions to reduce the risk of incorrect operation including frequent and multiple measurements of face pressure, measurement of excavated quantities compared with theoretical and automatic monitoring of the lining grouting process. All these functions would be monitored underground and remotely. Machine maintenance probably presents the highest risk level for this option. For planned maintenance, particularly of the cutterhead, areas where good ground conditions are expected would be chosen. For unplanned maintenance, the TBM will have facilities to apply compression air pressure to the bulkhead chamber onto which workers can enter with the appropriate compression and decompression times. Therefore, for construction risks, the bored tunnel is considered to be moderate or low risk.

#### *Drill-and-Blast Tunnel*

For the drill and blast tunnel, the construction risks again relate to geotechnical conditions. This technique does not provide the ability to pressurize the excavation face and for this reason the tunnel alignment has been lowered to increase the separation from the seabed. This is likely to reduce the generalized water ingress but does increase the potential hydrostatic pressure that may be present if a fault extends to the seabed. The only tool available to address these risks is rock grouting. This is generally effective but has failed in some cases. Therefore, for construction, the drill-and-blast tunnel is considered to be high risk.

#### *Immersed Tube Tunnel*

For the immersed tube tunnel, the construction process is exposed to the same risks that have been identified for the bridge option. In fact, the construction process is likely more sensitive to the environmental conditions, and would be significantly lengthened by limitations in seasonal working. Significantly an ITT in this location would have some unprecedented aspects. These include depth of immersion, length of tunnel,

excavation of rock at depth underwater, and substantial excavation volumes. Therefore during construction, the immersed tube tunnel is considered to be a high risk alternative.

### *Operational Risks*

#### *Bridge*

The bridge option presents considerable risk to the operation of the facility during the winter. These risks relate to snow and icing coupled with high winds, and fog conditions. It is presumed that issues related to iceberg and sea ice will have been addressed within the design of protection measures; however, there is always some risks associated with the interaction of an iceberg with the protection works. Further risk is associated with the possibility of ship impact although this is likely to be low probability with modern navigation equipment. In total, the risk of having operational interruptions in the winter months is considered to be high.

#### *Causeway*

The causeway option is exposed to the same environmental risks for the bridge but may be marginally less sensitive to wind and icing. In total, the risk of having operational interruptions in the winter months is considered to be high.

#### *Tunnel Options*

In terms of operational risks, all tunnels are considered to be similar for most risks. The major risk of service interruption is associated with breakdowns or accidents within the tunnel. For the road tunnels, the cross section has been selected to allow a broken down vehicle to be passed by other vehicles. This, together with CCTV monitoring of the tunnel, should significantly reduce the risk of service interruptions due to breakdowns.

For more substantial accidents and fires, an emergency egress passage has been provided and a fire suppressor system will likely be included to protect the structure and to reduce the closure time. Although fires in tunnels tend to be dramatic, their frequency is low, particularly for rail tunnels. Therefore, in total, the risk of having operational interruptions in the tunnel options is considered to be low. For the ITT, there is a risk of iceberg impact which could lead to substantial protection work repairs or damage to the ITT element itself.

### *Comparison Summary*

Tables 4.2 and 4.3 provide a comparative summary of the road and rail options, respectively. It is seen that the TBM rail tunnel has the lowest capital cost and lowest risk. The construction schedule is similar to the ITT schedule at 15 years; however, the ITT costs are more than three times as high. For the purpose of the economic and business case analysis, the TBM bored rail tunnel will therefore be carried forward.

**Table 4.2 - Comparison of Fixed Link Road Options**

<b>Option</b>	<b>Construction Cost (\$M-2004)</b>	<b>Annual Operating Cost (\$M-2004)</b>	<b>Risk Level</b>	<b>Project Duration (years)</b>
TBM Bored Tunnel	1,559	6.8	Moderate	12.2
Drill & Blast Tunnel	1,800	6.8	High	17.8
Immersed Tube Tunnel	4,810	6.8	High	14.7
Bridge	4,227	16.9	Extreme	15
Bridge / Causeway	10,123	4.3	High	18

**Table 4.3 - Comparison of Fixed Link Rail Options**

<b>Option</b>	<b>Construction Cost (\$M-2004)</b>	<b>Annual Operating Cost (\$M-2004)</b>	<b>Risk Level</b>	<b>Project Duration (years)</b>
TBM Bored Tunnel	1,144	7.64	Moderate	12.5
Drill & Blast Tunnel	2,272	7.64	High	23.8
Immersed Tube Tunnel	3,814	7.64	High	15

## 5 DEVELOPMENT OF THE PREFERRED ALTERNATIVE

The previous section concluded that a TBM bored rail tunnel was the preferred alternative based on costs, risk and schedule. Further consideration is given here to improving the construction schedule and reducing costs.

### 5.1 Schedule

An option for reducing the construction duration was addressed. This was to change the work week from five to seven days and to use an additional TBM to allow concurrent tunnelling from both sides of the Strait.

The use of a second TBM will only be possible if sufficient power supply is available to serve the Labrador site. The TBM is likely to have a total connected power of about 4000 kW although the demand will be less than this. The recent introduction of variable frequency drives on TBMs may also reduce this requirement somewhat. In any event, power on the Labrador side would not be available under the current isolated grid arrangement. Thus a dedicated power plant would have to be provided by the construction contractor for this purpose unless additional power becomes available in the interim. This has been assumed in the cost estimate.

The resulting schedule is shown in Figure 5.1. The reduction in the schedule is 52 months from the previous 180 months. This assumes that 50% of the tunnelling work will be completed from Newfoundland and 50% from Labrador. This is unlikely to actually occur as one side will always advance farther than the other. This effect will likely offer some further schedule reduction but is beyond the level of detail required for this analysis. The reduction in the schedule, over one TBM, is 22 months.

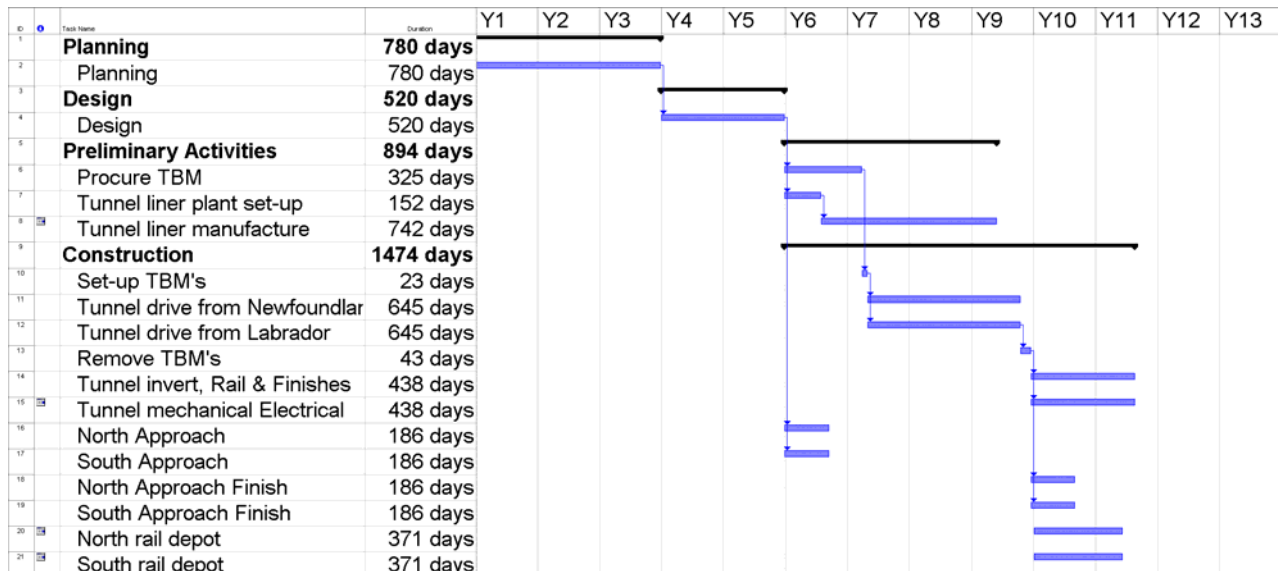

Figure 5.1 Project Schedule for the Preferred Option  
Using Seven Day Work Week & Two TBM's

## 5.2 Cost Comparison

Table 5.1 provides the adjusted costs for the previously described option refinements.

**Table 5.1 Costs for Preferred Option Refinements**

<b>Option</b>	<b>Construction Cost</b>	<b>Annual Operating Cost</b>	<b>Risk Level</b>	<b>Project Duration (Years)</b>
1 TBM (5 day week)	1,144	7.64	Moderate	12.5 years
2 TBM's (7 day week)	1,184	7.64	Moderate	10.7 years

The overall development cost for the 2 TBM arrangement includes an allowance for the installation of HVDC cables, escalation, and IDC (Interest During Construction). Including the HVDC cable cost of \$77 million brings the construction cost to \$1261 million in 2004 dollars. In Section 8.2, escalation is shown to be \$266 million and IDC, \$258 million. The total development cost and the cost to finance is thus \$1708 million.

## 6 REGULATORY AND ENVIRONMENTAL ISSUES

A complete assessment of the environmental implications and requirements of a fixed link project would be undertaken as the project moves forward through its various stages. As the feasibility of the project is firmed up and at an appropriate time, formal documentation would be submitted by the project proponent to fulfill regulatory requirements. The outcome of this submission would determine the degree of environmental investigation and studies required for the project. The project would require federal and provincial approvals under the Canadian Environmental Assessment Act and the Newfoundland Environmental Act. Current practice does allow screening and registration under one jurisdiction with both levels of government acting as regulatory agencies jointly. A detailed list of the applicable legislation, standards and permits that would have to be obtained is included at the end of this discussion.

The documentation to be submitted would likely be substantial and in component parts to address the potential areas of interest and mitigation measures. The time frame for the overall process could be several years; for the purposes of developing preliminary schedules in this report, three years were assumed.

As part of the determination of final feasibility, a drilling program would be required to obtain better information on the geology of the bedrock that would be tunneled. Environmental approval would be required for this feasibility level activity before such a program could be carried out. A formal application process would be followed which would identify the various processes to be undertaken; regulators would then determine the degree of environmental assessment required before the drilling could proceed. Such an assessment may pertain to potential effects of the drilling on marine life, fishing activity and marine traffic.

At the current pre-feasibility level of study, some comments may be made on the potential environmental implications of constructing a tunnel under the Strait.

First of all, by building a tunnel, the effect on the environment, in particular the physical environment of the Strait, is minimized. There is no concern, obviously, for the potential large scale oceanographic and climatic effects that might be wrought by a surface crossing such as a causeway and bridge. In the location of the Strait itself, there would be no or very little effect from the actual tunneling process or from the traffic once the tunnel is completed. There may be some concern for the effect of noise on marine life during construction; there should be sufficient information from other marine tunneling projects to address any such concern. An occupational health and safety concern relates to the potential effects of the construction on the workers. Emissions from the mucking system operation would have to be controlled within certain limits for this purpose.

The principal concern with respect to the tunnel itself is likely the disposal of the excavated material. This would have to be transported to suitable disposal sites on both sides of the Strait if the tunnel is advanced from both ends. The volume of material on each side would be approximately 730,000 m<sup>3</sup>. This is sufficient to cover an area of 7.3 hectares at a depth of 10 m. Material would have to be transported and disposed of in an environmentally acceptable manner at approved disposal sites. Consideration may have to be given to the sea water that would drain from the material over time. It is possible that some of the material could be used for road construction and general fill purposes in the approaches and terminus areas.

The other components of the project relate to the work required on both sides of the Strait to prepare the approaches and the facilities in the terminus areas. The construction associated with these activities is common to most road and buildings projects. Attention must be paid to the crossing of any stream with both



appropriate design to accommodate fish flows and the implementation of procedures to prevent deleterious runoff during construction, the appropriate containment of fuels, and the transport and disposal of surface vegetation and any unsuitable excavated subsurface material. As far as is known, there are no rare species of plant or animal life or archaeological relics in the study areas, the general surrounding areas have been inhabited for a long time, and thus, there is not expected to be any unusual environmental effect resulting from such construction and operational activities in the study area.

Overall, while the project would be a major undertaking over a long construction period, its nature is such that there would not likely be major environmental concerns that are outside the realm of a more typical heavy construction and earth moving project.

## 6.1 List of Applicable Legislation, Standards, and Permits

### *Federal*

#### *Legislation*

- ♦ The Canadian Environmental Assessment Act
- ♦ The Canadian Environmental Protection Act
- ♦ Fisheries Act
- ♦ The Navigable Waters Protection Act
- ♦ Fish Habitat, Authorization for Works or Undertakings Affecting Fish Habitat (HADD)
- ♦ Application for Construction within Navigable Waters
- ♦ Canada Labour Code
- ♦ Permit for Construction within Navigable Waters

#### *Standards*

- ♦ National Building Code of Canada (NBC)
- ♦ National Master Specification (NMS)
- ♦ International Organization for Standardization (ISO) Standard 9001 – Quality Systems
- ♦ Fire Commissioner of Canada Standards
- ♦ Applicable CAN/CSA standards
- ♦ NFC – National Fire Code
- ♦ National Plumbing Code
- ♦ Canadian Electrical Code
- ♦ National Energy Code of Canada
- ♦ Local Municipal Service Standards
- ♦ RTAC Road Design Manual

## *Provincial*

### *Legislation*

- ♦ Environmental Protection Act
- ♦ Water Resources Act
- ♦ Accessibility Act and Regulations
- ♦ Historic Resources Act
- ♦ Occupational Health and Safety Act
- ♦ Crown Lands Act
- ♦ Well Drilling Act
- ♦ Lands Act
- ♦ Forestry Act
- ♦ Wildlife Act
- ♦ Waste Material Disposal Act
- ♦ Quarry Materials Act
- ♦ Mineral Resources Act
- ♦ Environmental Assessment Regulations
- ♦ (GAP) Regulations – A Certificate of Approval is required for the storage and handling of gasoline and associated products (underground or above ground)
- ♦ Provincial Accessibility Act and Regulations
- ♦ Provincial Occupational Health and Welfare Regulations
- ♦ Historic Resources Assessment Permit

### *Permits*

- ♦ Crown Lands – Application for Grant Pursuant to Lease/Permit to Occupy Crown Land
- ♦ Application to Construct Extension or Accessory Buildings alongside all Protected Roads or Development Control Areas in the Province
- ♦ Temporary Storage Remote Locations
- ♦ Sewage Treatment System Commercial – Certificate of Approval for systems
- ♦ Archaeological Research Permit – Archaeological investigations on land or under water
- ♦ Construction (Site Drainage) Certificate of Approval
- ♦ Culvert Installation, Certificate of Approval
- ♦ Well Drilling
- ♦ Water and Sewer Works for private and municipal, Certificate of Environmental Approval
- ♦ Water Course Alterations, Certificate of Environmental Approval to Alter a Body of Water
- ♦ Water Course Crossings, Certificate of Environmental Approval
- ♦ General Application for Water Use Authorization – for all beneficial uses of water from any source
- ♦ Quarry Development Permit – Exploration Permit for Geotechnical Drilling
- ♦ Provincial Land Development Approval
- ♦ Provincial approval for watercourse crossings
- ♦ Provincial approval for general construction practices
- ♦ Provincial Fuel Storage Tank Approval

- ♦ Environmental Approval for culvert installation
- ♦ Certificate of Environmental Approval for any alteration to a body of water

*Municipal*

- ♦ Approval to Develop Land
- ♦ Permit to Construct from local municipal jurisdiction
- ♦ Land Use Development Regulations
- ♦ Building Permits
- ♦ Protected Roads and Development Control Regulations

## 7 ECONOMIC AND BUSINESS CASE ANALYSIS

This section sets out the economic and business case analysis. Three cases are described:

- The Base Case - bored (TBM) tunnel with a railway shuttle;
- Upgraded Ferry Link from St Barbe to Blanc Sablon; and,
- The Base Case augmented by High Voltage Direct Current (HVDC) transmission income.

The tunnel option under consideration uses two TBM machines and a seven day work week; thus, the period for planning design and construction of the facility is 11 years and the operating period examined is 30 years, for a total economic life cycle of 41 years. Sensitivity analyses were also carried out to assess the possible effects of significant changes to the assumptions underlying these forecasts. There are three major parts to this Section, as follows:

- Transportation Demand
- Tolls and Revenue Forecasts
- Economic Evaluation

### 7.1 Transportation Demand

Transportation demand projections are developed based on an understanding of the existing markets served. Consideration of the potential of new market opportunities attributable to the existence of a fixed link are then developed to estimate future traffic levels. The sub-sections are as follows:

- Markets Served
- Primary Target Markets
- Traffic Projections - Fixed Link
- Traffic Projections - Upgraded Ferry Link

#### 7.1.1 Markets Served

The existing markets for transportation between the Mainland and the Island of Newfoundland are described briefly below.

- St. Barbe to Blanc Sablon (Ferry)
- Quebec North Shore (Coastal Shipping)
- Direct Water Route (Oceanex)
- Marine Atlantic (Ferry)

#### *St. Barbe to Blanc Sablon*

Surface freight and passenger transportation between St. Barbe, NL and Blanc Sablon, QC is currently available by ferry between May 1 and mid-January, depending on weather conditions. The Government of Newfoundland and Labrador, Department of Transportation and Works recently renewed a four-year contract with Labrador Marine Inc to operate the M/V *Apollo* across the Strait of Belle Isle. The current contract

started in 2004 at an annual subsidy of approximately \$5.5 million including fuel that is purchased by the province on behalf of the operator. The M/V *Apollo* handles passenger and vehicle traffic only (all cargo must be in vehicles). The 108 metres long vessel has a certified passenger capacity of 240 (although it is capable of carrying 1,200 passengers), 220 cars and up to 6 tractor-trailers. The number of crossings per week varies with the season. In the peak season of July and August, the *Apollo* has 17 trips in each direction per week. For the rest of the operating period the frequency is 12 per week in May and June, 13 per week in September and October and 10 per week November 1<sup>st</sup> onwards. Each trip takes approximately 90 minutes, depending on the weather.

According to the Department of Transportation and Works, the demand for passenger service on this route has increased 59% for passengers, 76% for vehicles and 27% for tractor-trailers from 1999 to 2002. In 2003, the service was used by 23,229 vehicles (private passenger plus commercial vehicles). This service would provide a benchmark for toll pricing, revenues, traffic and costs for comparison with the impacts of a fixed link that would replace this ferry service. For year 1 (2004) of the study period a total vehicle count of 24042 was used, based on information provided by the Department of Transportation and Works.

### *Quebec North Shore*

Access to Labrador Coastal Drive is also available by another seasonal ferry operated by Groupe Desgagnés under contract to Transports Québec. The M/V *Nordik Express* provides weekly passenger and freight service to the Quebec North Shore from Rimouski terminating at Blanc Sablon from May to January. This 1,865-ton ship has a capacity of 268 passengers with 282 m<sup>2</sup> of deck cargo space. The 3½-day trip stops at 10 villages between Rimouski/Sept-Îles and Blanc Sablon for passengers and freight; one trip is made each week in each direction. The volume of traffic to the Island of Newfoundland is not significant for this immediate analysis.

### *Oceanex*

Oceanex operates a regular container service from Montréal and Halifax to St. John's and Corner Brook.

The company's fleet includes the following vessels:

- M.V. *Cabot*, a 193 metre long ice class Ro/Ro (Roll-on/Roll-off) containership constructed in 1979. The *Cabot*, which is dedicated to the Montreal service, has a capacity for 644 TEU's (Twenty-foot Equivalent Units);
- M.V. *Cicero*, a 147 metre ice class Ro/Ro containership constructed in 1978. The *Cicero*, which is dedicated to the Montreal service, has a capacity of 420 TEU's; and
- M.V. *Sanderling*, a 193 metre ice class Ro/Ro containership constructed in 1977. The *Sanderling*, which is dedicated to the Halifax service has a capacity of 1,125 TEU's.

Oceanex offers two day service between Halifax and St. John's weekly, and three day service between Montreal and St. John's twice weekly. Service to Corner Brook is provided weekly by the *Sanderling* on its return trip from St. John's to Halifax.

Prospects for diversion from this service to a new fixed link are negligible for reasons that are more fully explained later in this text.

### *Marine Atlantic*

Marine Atlantic Inc. is a Federal Crown Corporation offering year-round passenger and freight ferry services from North Sydney, Nova Scotia to the Island of Newfoundland at Port aux Basques and summer service to Argentia. The North Sydney to Port aux Basques crossing is a constitutional obligation of Canada having been included in the Terms of Union between Canada and Newfoundland in 1949. The company's fleet includes the following vessels:

- M.V. *Caribou* -- An Ice Class 1A Super Ferry with capacity for 1200 passengers and 370 automobiles or 77 tractor-trailers. This vessel was custom built for Marine Atlantic and delivered in 1986;
- M.V. *Joseph and Clara Smallwood* -- An Ice Class 1A Super Ferry with capacity for 1200 passengers and 370 automobiles or 77 tractor-trailers. This vessel was custom built for Marine Atlantic and delivered in 1990;
- M.V. *Atlantic Freighter* -- was built in 1978 and purchased by Marine Atlantic from the Stena Line in 1986. It has capacity for 75 drop trailers and 12 passengers; and
- M.V. *Leif Ericson* -- was built in 1991 and purchased by Marine Atlantic in 2003. It has capacity for 500 passengers and 250 automobiles or 72 tractor trailers.

Off-peak season schedules to and from Newfoundland generally include twice daily ro-ro service between North Sydney and Port aux Basques using either the *Caribou* or the *Joseph and Clara Smallwood*. As well, the *Atlantic Freighter* provides drop trailer service between these ports on a demand basis.

Peak scheduling generally includes thrice daily service between North Sydney and Port aux Basques and thrice weekly service between North Sydney and Argentia. The latter is largely a passenger related service that carries very few commercial vehicles.

Crossing times, on the North Sydney to Port aux Basques service are 6 hours, and on the North Sydney to Argentia crossing, are approximately 14 hours. During peak season operations, faster sailings can occur. The Gulf Ferries are a source of traffic that could be diverted, at least in part. Both existing and upgraded service offerings would be used as benchmark references for estimating diversion potential. Traffic originating west of Quebec City might be diverted along a new Trans Canada Highway link to Blanc Sablon along the North Shore of the Gulf of St. Lawrence.

During 2003, Gulf Services in both directions accounted for approximately 151,000 passenger vehicles and 81,000 commercial vehicles.

#### *7.1.2 Primary Target Markets*

Future potential demand for a fixed link can come from a number of sources, as follows:

- New developments to attract tourism and induced demand (i.e. new demand for trip making that is "induced" by the existence of the tunnel or the convenience it may afford, not traceable to historical trends)
- New economic developments to attract long term commercial vehicle traffic and major projects that can generate elevated demand for defined periods (e.g. construction of Lower Churchill Power Generating capacity)

*Tourism And Induced Demand*

Tourism is important for the economy of Newfoundland and Labrador over the time frame under consideration. New potential growth could result from creation of new National and Provincial Parks, expansion of tourism infrastructure including hotels and dining facilities, and successful major advertising campaigns. There is little specific evidence upon which to build growth projections. Implications of this type of potential are developed by indirect approaches, contacting Zonal Boards and tourism departments, and drawing inferences from comparable studies.

For example, discussions were held with representatives of Zonal Boards in Central and Southern Labrador, and Western Newfoundland to determine the status of potential major projects that could impact upon traffic demand for the Fixed Link. Based upon these discussions, no identifiable major new projects in the conceptual and initial planning stages were identified.

*Provincial Trends*

A number of sources have been reviewed to arrive at conclusions on the expected range of impacts from the project. Table 7.1 details the markets which the Department of Tourism, Culture and Recreation has identified as offering the best potential for tourism activity in Newfoundland and Labrador:<sup>1</sup>

**Table 7.1 - Tourism Markets**

<b>Geographic Markets</b>	
<b>Primary</b>	<b>Secondary</b>
Ontario	North-east USA
Maritimes	
<b>Primary Purpose of Trip Markets</b>	
<b>Primary</b>	<b>Secondary</b>
Sightseeing / Touring	Adventure / nature viewing
Hunting / Fishing	Meetings , Conventions and Incentive Travel

The Maritimes and Ontario are the largest non-resident markets, with the Maritime provinces accounting for 42% of non-resident visits and Ontario accounting for 32% in 2003. The primary and secondary geographic markets for Newfoundland and Labrador are similar to Nova Scotia; thus, filling "data gaps" in Newfoundland and Labrador can draw from insights obtained from studying Nova Scotia trends. See Table 7.2.

<sup>1</sup> Newfoundland and Labrador Tourism Marketing Strategy Review, prepared by Economic Planning Group of Canada, November 2002, P ii.

**Table 7.2 Non-Resident Visitors to Newfoundland and Labrador**

<b>By Origin: January to December</b>					
<b>Origin</b>	<b>Auto</b>			<b>Air</b>	
	<b>2003</b>	<b>2002</b>	<b>2001</b>	<b>2002</b>	<b>2001</b>
Nova Scotia	43,042	49,115	46,710	29,320	30,089
P.E.I	2,774	3,153	2,960	1,816	1,864
New Brunswick	13,205	15,983	13,776	8,303	8,521
<b>Total Maritimes</b>	<b>59,021</b>	<b>68,251</b>	<b>63,446</b>	<b>39,439</b>	<b>40,474</b>
Quebec	8,354	8,794	6,823	12,973	13,314
Ontario	44,582	50,562	42,097	107,419	110,238
Western Canada	9,603	11,083	8,721	45,926	47,131
New England	4758	5,860	5,254	5,449	5,592
Mid Atlantic	3364	4,171	3,656	6,227	6,391
East North Central	2151	2,838	2,672	4,670	4,793
South Atlantic	3837	4499	4126	5708	5858
Other USA	4679	5,319	4,878	11,676	11,982
<b>Total USA</b>	<b>18,789</b>	<b>22,687</b>	<b>20,586</b>	<b>33,730</b>	<b>34,616</b>
International	58	141	102	19,719	20,237
<b>Total</b>	<b>140,401</b>	<b>161,442</b>	<b>141,675</b>	<b>259,467</b>	<b>266,276</b>

*Source: Dept. of Tourism, Culture and Recreation: Data for Air travelers for 2003 were not available at the time of writing.*

Table 7.3 below provides an overview of the volume of non-resident visitors to Newfoundland and Labrador for the past 10 years. Total visits to the province have increased overall by 30% from 1996 to 2003. More than half the visitors come during the peak tourist season (June-September); in fact, the ratio of peak to annual visitors has increased from around 51% in 1994 to over 54% in 2003.

Also, more recent information (Non-Resident Summary Statistics, Department of Tourism, Culture and Recreation, April 2003) reveals a newly emerging market for cruise ship arrivals. It appears to be growing from a small base of 10,000 to 20,000 visitors per year. Significant annual fluctuations since the data were first captured in 1998 conceal evidence of any trend in these early days.



**Table 7.3 Annual Non-Resident Visits and Expenditures (\$ Millions)  
Newfoundland and Labrador: 1994-2003**

Year	Auto		Air		Total
	Visitors	Expenditures	Visitors	Expenditures	Visitors
1994	114,629	\$46.2	214,800	\$119.0	329,429
1995	118,133	\$48.5	204,364	\$119.9	322,497
1996	109,626	\$46.3	195,436	\$118.2	305,062
1997	122,425	\$56.2	247,265	\$175.5	369,690
1998	127,960	\$60.3	244,253	\$177.8	372,213
1999	140,864	\$68.0	256,600	\$195.4	397,464
2000	149,975	\$75.3	266,480	\$212.1	416,455
2001	141,675	\$72.2	266,276	\$215.1	407,951
2002	161,442	\$85.2	259,467	\$216.0	420,909
2003	140,401	\$74.1(E)	287,300	\$239.1(E)	427,701

Source: Department of Tourism, Culture and Recreation

(E) – estimated

The Department of Tourism, Culture and Recreation did an in-depth auto exit survey for the Province in 1997. This survey gives insight into the profile of the non-resident visitors on a sub-provincial basis. The methodology behind the survey was to administer a questionnaire to a sample of passengers in vehicles exiting Newfoundland and Labrador via Argentia or Port aux Basques on the ferry during June to October 1997.

Information from the 1997 Auto and Air Exit Survey of the Department of Tourism, Culture and Recreation is converted to 2004 dollars using the Consumer Price Index to estimate spending by tourists. The average daily expenditures for non-resident auto visitors are estimated at \$93 (business), \$59 (pleasure), \$32 (visiting friends and relatives) and \$52 (other visitors). The overall daily average is \$49. Those visitors entering the Province by air have a higher overall daily expenditure at \$90 with the purpose of trip breakdown being \$165 (business), \$128 (pleasure) and \$51 (visiting friends and relatives).

From the above expenditures, distributions of traveller type have been assumed as follows:

Auto visitors: 10% business  
 30% pleasure  
 50% visiting friends and relatives  
 10% other

Air visitors: 20% business  
20% pleasure  
60% visiting friends and relatives

These distributions provide average expenditures that approximate those given above.

For the traveller type distribution for the users of the fixed link, the business travellers have been assumed not to use the facility. Further, for the auto travellers it is assumed that the pleasure traveller component would increase significantly. Therefore the following distributors have been used.

Auto visitors: 50% pleasure  
40% visiting friends and relatives  
10% other

Air visitors: 25% pleasure  
75% visiting friends and relatives

Base on Table 7.3, the ratio of the auto visitors to our visitors is 35% auto versus 65% air. This gives an average expenditure to be employed in this study of \$62.35 (2004 dollars).

It is apparent that air visitors are an important segment of the tourist market. Visitors from further away than the Maritime Provinces destined to tourist attractions in the Great Northern Peninsula and in Labrador tend to fly in and rent cars for their local sightseeing. Many of these tourists are round-trip travellers across the Strait of Belle Isle.

Since there is not enough information to break down the expenditures by region, this spending pattern will be taken as the benchmark for estimating incremental tourism expenditures.

#### *Regional Tourism Insights*

The 1997 Survey also estimated that on a regional basis, 37.8 % of the nights that non-residents auto visitors spent were in Western Newfoundland, 28.4% were on the Avalon Peninsula, 23.0% in Central Newfoundland, 9.7% in Eastern Newfoundland and 1.0% in Labrador.

Other findings from this survey are:

- The primary reason for travel to Newfoundland and Labrador by non-resident auto visitors was sightseeing, followed by visiting friends and family, pleasure seekers, business travelers and finally "other" reasons. 'Pleasure' includes outdoor recreation, special events, fishing etc.
- Greater than two-thirds of the non-resident auto visitors reported Newfoundland and Labrador as their primary destination, while less than one-third indicated the Province visit was part of an Atlantic Canada tour.
- The average party size was 2.67 persons and the most popular group composition was as husband and wife, at 41.5% of the population surveyed. The average length of stay was 11 nights with average expenditures at \$41.76 per night per person (1997 dollars). Therefore, the average party was spending \$1,226 per visit.
- Activities which generated the most interest in overall market segments were iceberg viewing, whale watching, boat tours, visiting historical sites/museums, scenic touring and attending festivals/events,.

These data suggest that those traveling to Newfoundland and Labrador are interested in activities related to the natural and historical heritage of the Province's coastlines.

The primary sources of data concerning Labrador include data from the annual Statistics Canada surveys of both domestic and international travel to and within Canada. The sample size for Labrador is too small for breaking out any details, but the figures do provide some sense of the number of visits. Data for the year 2000 show the following:

Overnight visits to Newfoundland & Labrador of 1 plus nights

Overseas –	99,900
US –	49,700
Total –	149,600

Overnight visits to Labrador

Overseas –	4,900
US –	6,700
Total –	11,600

The only other useful source of data for Labrador tourism is ad hoc data from operators throughout Labrador. There are accessible data on passenger movements across the Labrador Straits from May to October. The *Apollo* ferry data for the Labrador Straits include significant resident travel, but it may also provide a proxy for tourist visitation growth. For comparative purposes, the out-of-province visits to the Great Northern Peninsula exceed 50,000 annually.

The major attractions in the region posted visitation levels as follows:

- ♦ Red Bay National Historic Site – 8,144 between June and September 2000(6% increase over 1999).
- ♦ Pointe Amour Lighthouse – 4,584 visitors between June and October 2000 (decrease of 4% over 1999).
- ♦ Battle Harbour – average of 2,000 visitors between June and October 2000.

The Newfoundland and Labrador Exit Survey of 1997 is being updated in 2003/04. The new data are not yet available for use in this study. Therefore 1997 data is the best available indicator of current and expected future conditions. The data were compiled from interviews of air and auto visitors to the 21 tourism zones in Newfoundland and Labrador. Two zones are in Labrador and another two zones are located in the adjacent area of Western Newfoundland.

Air visitors to Southern Labrador represent less than 1.5% of the party visits, less than 0.5% of party nights and stay around five days. This profile is not expected to change significantly with a fixed link. Auto visitors have a different profile. In 1997, Southern Labrador accounted for 2.4% of party visits and 0.43% of party nights with the average stay ranging from 1.7 nights in the Labrador Straits to 3.0 nights in Mary's Harbour to Cartwright. It is important to note that the auto visitor profile for Mary's Harbour to Cartwright is representative of conditions prior to the completion of the Trans-Labrador Highway to Cartwright.

Another approach used was to examine accommodation occupancy data. The Department of Tourism, Culture and Recreation collects occupancy statistics on a monthly basis for each tourism zone. Operator participation in this survey can vary from year to year but overall trends can be isolated. As a proxy of

changes in Southern Labrador and Western Newfoundland since the completion of the Trans Labrador Highway to Cartwright, the year 1999 was selected as the base year. The compounded annual increase in room nights sold was:

- Zone 4                      Mary's Harbour to Cartwright                      2.7%
- Zone 5                      Labrador Straits    2.4%
- Zone 4 & 5                      Southern Labrador    2.5%
- Zones 6 & 7                      Great Northern Peninsula    3.4%

Zones 4 and 5 have spare capacity to meet increased visits from a fixed link to Newfoundland. In 2003, Southern Labrador had an annual occupancy rate of 32%. The available room nights were around 34,900 and total rooms sold were approximately 7,650. The monthly occupancy ranged from 16% in January to 64% in July and 61% in August. Occupancy rates were 47% in both shoulder months, June and September. The current accommodation occupancy profile indicates spare capacity that could be fully or partially utilized given improved access from a fixed link.

*Tourism Projections*

Based on the above trends and information, it is apparent that tourism to Newfoundland and Labrador is growing at an increasing rate, and that the share of market in Southern Labrador and the Great Northern Peninsula is keeping pace with the overall trend. The base case projection, therefore, with or without a fixed link will be to sustain 3.5% annual growth in tourism, broadly based on recent trends for the Great Northern Peninsula. This would be applied to a base number of visitors of 13000. This is derived from overnight visits to Labrador in year 2000 inflated by 3.5% per year to year 2004.

There is a basis to consider that the annual growth in visits can be sustained at its current level, and possibly increased with completion of a fixed link based on improved accessibility for vehicles. Emphasis on related marketing initiatives in the study area will influence the actual outcome. The excess growth over the base case projection will be used to estimate economic spin-offs attributable to construction of a link.

As mentioned above, tourist spending will be determined at the rate of \$62.35 per person-night. Induced trips are based on the average overall stay of 11 nights in the province, and diverted trips are considered to add on the Great Northern Peninsula and Labrador to an existing itinerary, so one night per trip is considered to be the incremental stay. These are the factors applied to incremental trips to estimate total tourism direct expenditures as inputs to estimates of economic impact.

*New Economic Developments To Attract Long Term Commercial Vehicle Traffic*

Labrador is a large land mass with significant natural resources. One may envisage a long term scenario in which the development of such resources could lead to the populating of southeast parts of this land mass and to the increased movement of people, goods and services from one part of the province to the other. In such a scenario, a fixed link would promote the development of more vibrant and viable communities on both sides of the Strait. It is in the context of such a vision that a review was made in this study of potential industrial development opportunities in Labrador and how such developments might foster population growth in the area and movement across the Strait.

### *Mining*

While there is a large mining industry in Labrador, it is located in the west and north. Discussions with the provincial government suggest that the opportunity for significant mining development in southeast Labrador is low given the geological structure of the area. This part of Labrador falls within the Grenville province which is known primarily for dimension stone rather than any commercial quantities of minerals. There may be pockets of small deposits but these would not be expected to lead to large-scale developments like Voisey's Bay, for example. If there were to be mining developments in the area, product would be very likely shipped by sea to its destination.

### *Forestry*

A rather spasmodic, small forestry industry has existed in southern Labrador for a long time as a number of small sawmills have come and gone. Various plans have been developed for major lumber and pulp enterprises, perhaps the largest of these being the proposed harvesting of fibre for the former linerboard mill at Stephenville on the Island of Newfoundland. Today, pulpwood is cut in the Port Hope Simpson area and is barged to the Island for use by Abitibi Consolidated in Stephenville. It would not be cost competitive to ship fibre by road through a fixed link given today's fuel and paper prices, except in periods of high demand and constrained capacity by water. A small amount of lumber is also sawn as a part of this operation for use in the local area.

It might be argued that a larger sawmill industry could ship finished lumber through a fixed link to the Island for retail or for transshipment to other points. It is also possible that, if the road along the Quebec north shore were completed as part of an overall link project, lumber could be shipped westward by road.

### *Natural Gas*

The Labrador Shelf holds substantial reserves of natural gas as proven during exploration in the area in the late 1960's. The current technology for producing, processing and shipping natural gas from offshore fields is through either a pipeline to shore or liquefying offshore and shipping in special LNG carriers. Developments are also underway to research, design and test vessels for the transport of compressed gas, without liquefaction (the so-called CNG technology), particularly from harsh environment areas such as the Grand Banks where a simplification of the processing that is done offshore would be beneficial. When, and if, Labrador gas is developed, this method may have application. It is unlikely that a pipeline to shore would be feasible because of iceberg scour, and in any event, transshipment from shore would still be required to reach market. A fixed link between Labrador and the Island of Newfoundland would have no known benefit to such an industry.

### *Hydroelectric Developments*

The development of hydroelectric capacity on the Lower Churchill River has been referred to in this report in the context of transmitting some of the power developed to the Island of Newfoundland. The potential capacity at two sites on the river is approximately 3000 MW. It has been stated on various occasions in the public domain that these projects represent the single largest and lowest cost undeveloped hydroelectric potential in North America. One concept, which would mesh with the overall vision of integrating the two parts of the province and promoting the development of northern Newfoundland and southern Labrador, is to build an industry, based on aluminum smelting, around the availability of electricity from a Lower Churchill Development. It is well known that aluminum smelters use large amounts of electricity and the major international companies locate plants around the world at sites of low-cost power. One of the latest examples is an ongoing development in Iceland in which Alcoa is building a smelter that will use power from a new

hydroelectric development in that country. There are several such existing developments in Quebec also. If one considers the concept presented in this report of a fixed link with electrical transmission cables to the Island of Newfoundland, locating a smelter at the south end of the Strait, say, in the vicinity of the fixed link terminus would be more or less synergistic with the overall objective of government of physically linking the two parts of the province, providing electrical power to the Island from the Lower Churchill, and of providing an opportunity for social and economic success in northern Newfoundland and southern Labrador. However, aluminum smelting in this area has been studied on several previous occasions and has not been pursued. There are many factors that must be considered by a large industrial customer, such as an aluminum smelter, in siting a processing facility, that are beyond the scope of this report.

### 7.1.3 Traffic Projections - Fixed Link

The primary generators of new traffic for a fixed link are tourists (entering the province by both air and road) and freight that could possibly be diverted from other routes. The tourist market has potential for significant new growth once the link is open. The freight market will likely experience modest growth and some diversion from Marine Atlantic services. The traffic growth rates assumed for the crossing, with and without a fixed link, are presented in Table 7.4.

**Table 7.4 Traffic Growth Rates for Fixed Link**

% Annual Growth Rates	Without Fixed Link	With Fixed Link			
		Continuing Growth	Plus Post Completion Increment		
			One-time effects		Annual Increment to Growth
			Shift	Tunnel Surge	
<b>Strait of Belle Isle</b>					
Tourists	3.5%	3.5%			1.25%
Local and Business	2.2%	1.5%		30.0%	
Tractor-trailers	2.5%	2.5%			
<b>From Marine Atlantic</b>					
Auto	2.5%		10.0%	3.0%	1.50%
Tractor-trailers	2.5%		15.0%		1.00%

Projections of traffic growth rates without a fixed link are based on a 3.5% increase in overall tourist traffic as explained earlier, with an overall growth rate for all vehicles of 2.5% per year based on long term historical trends for total traffic to the Island of Newfoundland. Using 3.5% growth for the tourist component, results in a 2.2% growth for the local and business component, to achieve an overall growth of 2.5%

Post completion of the tunnel, four types of changes are evaluated.

- One time surge in demand affecting local and business traffic;
- Diversion from Marine Atlantic to the new fixed link;
- Sustained annual growth as indicated in the right hand column of Table 7.4
- Induced demand

The Confederation Bridge between Prince Edward Island and New Brunswick stimulated a 54% one time surge in traffic that has been sustained, but is not growing significantly from that new threshold. This suggests that travellers already operating on the route are now going back and forth with greater frequency because of the convenience of the fixed link. In the case of the proposed link across the Strait of Belle Isle, population density on either side of the link is considerably smaller than in the case of Prince Edward Island and New Brunswick and the diversity of trip purposes is relatively more restricted. Consequently, a more conservative estimate of one time surge to local and business traffic levels of 30% is used for this link. After the start of operations, the annual growth rate is used of 1.5%, slightly less than the 2.2% prior to the surge.

Determining the amount of diversion from Marine Atlantic to a fixed link is a more difficult proposition. In the first case, only that portion of traffic originating west of Québec City is likely to consider a Labrador alternative. In total, this market is about 30 to 40% of the traffic on Marine Atlantic, and a 10% overall diversion represents a significant portion of this market. With a continuous new road built along the north shore of the Gulf of St. Lawrence, some drivers might be induced to try this route, and if the experience proves rewarding then word-of-mouth advertising could sustain a reasonable growth rate.

With this optimistic outlook, the forecast traffic is based on 10% diversion of passenger vehicles from Marine Atlantic to the new fixed link. A one time induced surge in new volume equal to 30% of the diverted traffic, results in an initial traffic base for the new link that would be 13% of the previous year's projected traffic for Marine Atlantic. This traffic is assumed to continue to grow at the annual rate of 1.5%. Sensitivity analyses will test the significance of these assumptions to the overall economic assessment for the project.

With respect to freight, a net diversion from Marine Atlantic in the first year of 15% of the previous year's vehicle traffic is assumed. This is equivalent to 10% of the total trailer and container traffic to the Island, expressed as a percentage of Marine Atlantic. It is further projected that this volume will be sustained and continue to grow at a compounded annual rate of 1%.

Graphical representation of the growth in passenger and freight vehicle traffic both before and after completion of the tunnel is shown in Figures 7.1 and 7.2. The pre-operation traffic projections are self-evident, and the impact of the introduction of a fixed link is clearly shown by the sudden increase in traffic and the subsequent increased growth.

Passenger vehicle projections show the growth of the existing tourist and local markets. The largest segment, growing to approximately two thirds of the total traffic by the end of the study time frame, represents diversion and induced traffic. There is a need for more reliable information to understand this market segment and improve on these projections as the project moves forward.

A similar caveat applies to the forecasts for tractor-trailers. In this case, the reliance on traffic diversion and induced demand is even more prominent because the induced component is approximately seven times the existing traffic levels.

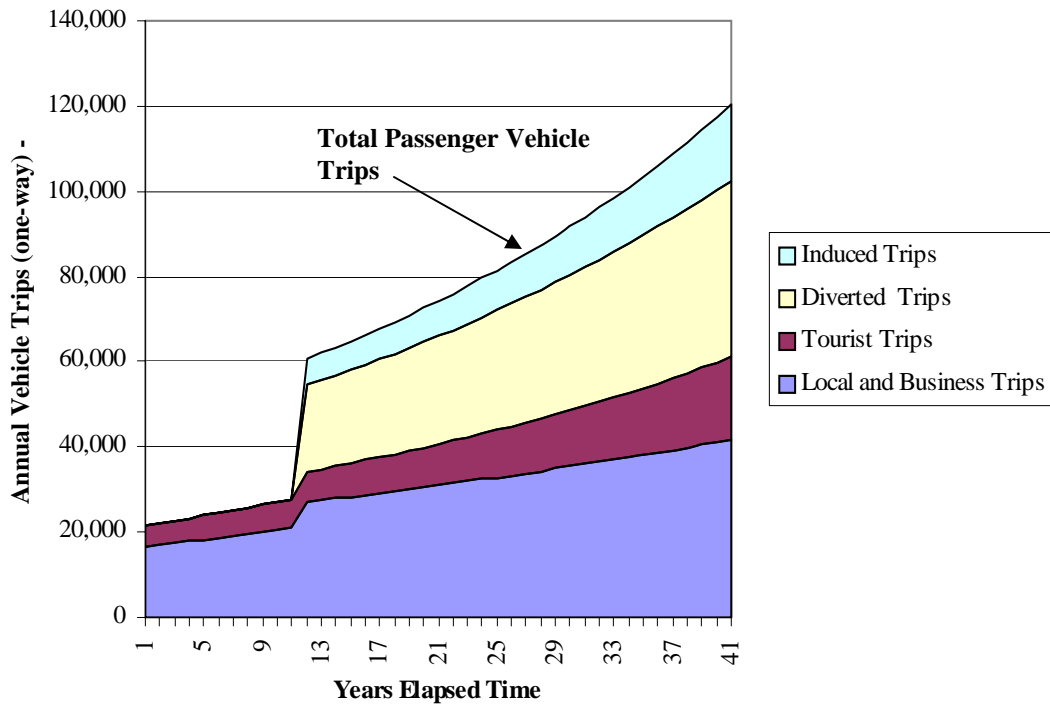

Figure 7.1 Passenger Vehicle Traffic Projections - Fixed Link

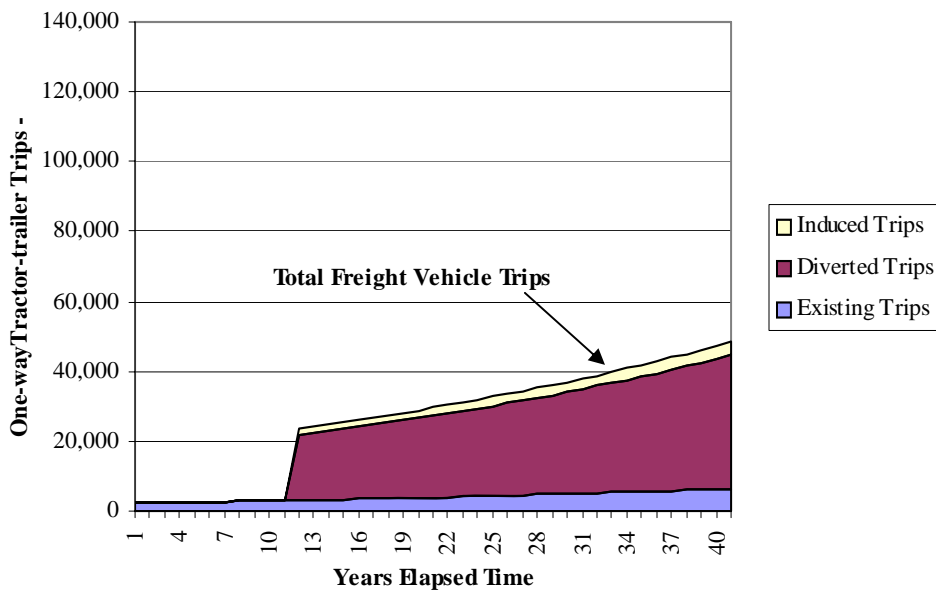

Figure 7.2 Freight Vehicle Traffic Projections - Fixed Link



### *Freight Transportation Considerations*

Transportation carriers estimate that inbound shipments to Newfoundland exceed outbound shipments by a factor of four or five to one. The large front haul imbalance creates a very competitive environment for Newfoundland back hauls. It also assists forecasting of freight traffic since one can concentrate on the factors influencing inbound shipments. This latter statement follows from the presumption that outbound shipments can be easily handled within the surplus available capacity. If one can reasonably estimate the number of traffic units required to accommodate inbound shipments, then total movements are simply inbound traffic units times two.

During the 1980s, Transport Canada's Economic Analysis Division completed an analysis of Newfoundland's inbound freight shipments over a period of approximately 20 years. This analysis concluded that there was a correlation between Newfoundland general freight shipments and changes in provincial Real Gross Domestic Product (Real GDP). For each one percent change in Newfoundland GDP, inbound freight shipments would on average be expected to change by 0.8 to 1.0 percent.

In recent years, the Province of Newfoundland and Labrador has experienced very high real rates of growth due largely to offshore petroleum developments. Provincial economic performance for the past five years is summarized in the Table 7.5. Annual rates of growth during this period exceed national performance by approximately 90%. The largest single increase occurred in 2002. The Terra Nova offshore development commenced production then and rapidly achieved full production levels. An increase in Hibernia output also contributed to the strong growth in the same year.

**Table 7.5 Newfoundland Gross Domestic Product (1997 Dollars) 1999-2003**

<b>Year</b>	<b>Nfld. GDP (millions)</b>	<b>% Change Nfld.</b>	<b>% Change Canada</b>
<b>1999</b>	11,715	5.5	5.5
<b>2000</b>	12,400	5.8	5.3
<b>2001</b>	12,509	0.9	1.9
<b>2002</b>	14,432	15.4	3.3
<b>2003</b>	15,364	6.5	1.7
<b>1999-2003, Average Annual Growth</b>		6.8	3.5

While healthy growth in inbound shipments has been recorded for the period being examined, it is evident that there has been a disconnect between rates of growth in Real GDP. Inbound freight shipments (shown in Table 7.6) have grown by an average of 2.75 per cent during the 5 year period being examined which is about 40% of the increase seen in Real GDP, or one-half the historical expected rate of growth. Both major carriers have participated in the growth of the freight market from 1999 to 2003, with Oceanex increasing its share slightly.

Offshore developments and their concomitant effects on GDP, although positive, did not translate into equivalent impacts in employment and other measures of economic activity.

There is relatively little inbound freight tonnage from Goose Bay to the Island of Newfoundland or from either northern or southern Labrador communities. Freight activity to coastal communities is largely of a re-supply nature and only a limited amount of freight has been travelling on the *Apollo* service from Blanc Sablon to the Island ferry terminal in St. Barbe. As noted earlier there was a one time surge in volume during 2003, but this is excluded from the current forecasts.

While general measures of economic activity in the 1999-2003 period have indicated robust growth in the Province, there has been significant emigration and Provincial unemployment levels hover in the 15-17% range. On the Great Northern Peninsula and in Labrador, unemployment rates are as high as 24%. Clearly not all of the wealth generated in offshore petroleum fields has translated into similar increases in demand for general freight and indeed for a number of economic measures. General freight growth has of course been positively influenced by the petroleum industry and has achieved a very respectable 2.75% per annum increase despite the significant emigration and high levels of unemployment.

**Table 7.6 Estimated General Freight Tonnage, Mainland to Newfoundland, 1999-2003**

<b>Marine Atlantic</b>	<b>1999</b>	<b>2000</b>	<b>2001</b>	<b>2002</b>	<b>2003</b>
Tractor Trailers	337,114	338,805	342,187	356,517	351,746
Drop Trailers	322,091	325,865	338,242	329,496	353,472
Straight Trucks	9,672	9,536	10,062	9,601	9,705
Other	3,520	4,570	1,330	0	0
Total M.A. Tonnes	672,397	678,776	691,921	695,614	714,923
% of Total	59.5	59.7	59.2	58.0	57.8
<b>Oceanex</b>					
Containers	426,760	423,056	443,751	466,144	485,704
New Vehicles	33,656	34,365	33,849	37,378	35,833
Total Ocean. Tonnes	460,416	457,421	477,600	503,522	521,537
% of Total	40.5	40.3	40.8	42.0	42.2
Total Inbound Freight	1,129,293	1,136,197	1,169,521	1,199,136	1,236,460
Annual % Change	4.7	0.6	2.9	2.5	3.1

There are some indications that emigration is levelling off and that the Newfoundland and Labrador economy will continue to record positive rates of growth in the 2.5% range for both 2004 and 2005. For years beyond 2005, the Newfoundland and Labrador Department of Finance notes that GDP will increase at higher rates owing to oil from the White Rose offshore project and the start of Voisey's Bay nickel production. The Department of Finance has adjusted future GDP projections to "exclude production income from major projects accruing to non-residents." These adjusted numbers show very little growth in the 2006-2007 period. It is interesting to note that the adjusted Real GDP figure for 2003 shows a 2.0% increase versus an unadjusted growth of 4.7%.

Based on recent history and the projection of modest growth for the short to medium term, a 2.5% per annum growth for general freight shipments for the duration of the study period is considered to be realistic as a base case.

Traffic diversion and induced demand represented the dominant source of traffic, as noted earlier. The reasons for great caution and uncertainty concerning this diversion potential are explained below.

The discussion, which follows is intended to reflect a carrier's perspective and largely pertains to driver accompanied traffic. Furthermore, the modal choice variables discussed are not mutually exclusive.

#### *Distance Travelled*

For shipments from central Canada to the Island of Newfoundland one can compute the impact of a fixed link by choosing common link points. Two common link points for a central Canadian shipment to Newfoundland using a fixed link or the existing Gulf Ferry service are Quebec City and St. John's as shown on Figure 7.3. Presupposing a highway is constructed along the north shore of the St. Lawrence to connect the Labrador Straits area with Natashquan and points west, driving distances from Quebec City to St. John's are roughly equal. There will therefore, be no distance advantage for highway-based travel from Central Canada to the Island of Newfoundland using a fixed link.

For travel from the Maritimes using Halifax as the point of departure, the fixed link route would add approximately 1,450 kilometres to a St. John's destination compared to the existing highway/Gulf Ferry connection. Therefore, for all practical purposes the fixed link routing alternative is not a viable alternative for Maritime province based travel.

#### *Travel Time*

Travel time is a function of distance and operating speed. From the above, using the Quebec City and St. John's link points, distances for both alternatives are equal. Operating speeds on the highways however could be expected to be different. Operating speeds on the Trans-Canada Highway from Quebec City to St. John's will be in the 100-110 kilometre per hour range. Virtually all of the Quebec to North Sydney portion of the highway is, or soon will be, four lane controlled access highway with posted speeds ranging from 100 to 110 kilometres per hour. Travellers along the North Shore of the St. Lawrence can be expected to experience operating speeds of 80 to 90 kilometres per hour. Similar average operating speeds on the Great Northern Peninsula section of highway can be expected. The Gulf Ferry takes approximately 6 hours with all vehicular traffic requested to be at the terminal at least one hour in advance of sailing (i.e. total of 7 hours). The fixed link crossing would take about 25 to 60 minutes, inclusive of terminal time. Thus a travel time advantage will occur in respect of the crossing.

Combining the impacts of operating speeds and crossing times, however, there is minimal difference in overall travel time from central Canada to the Island of Newfoundland. Figure 7.3 shows road distances between Quebec City and St. John's with driving times calculated based on the above speed assumptions. Ferry crossing times are not included in the times shown.

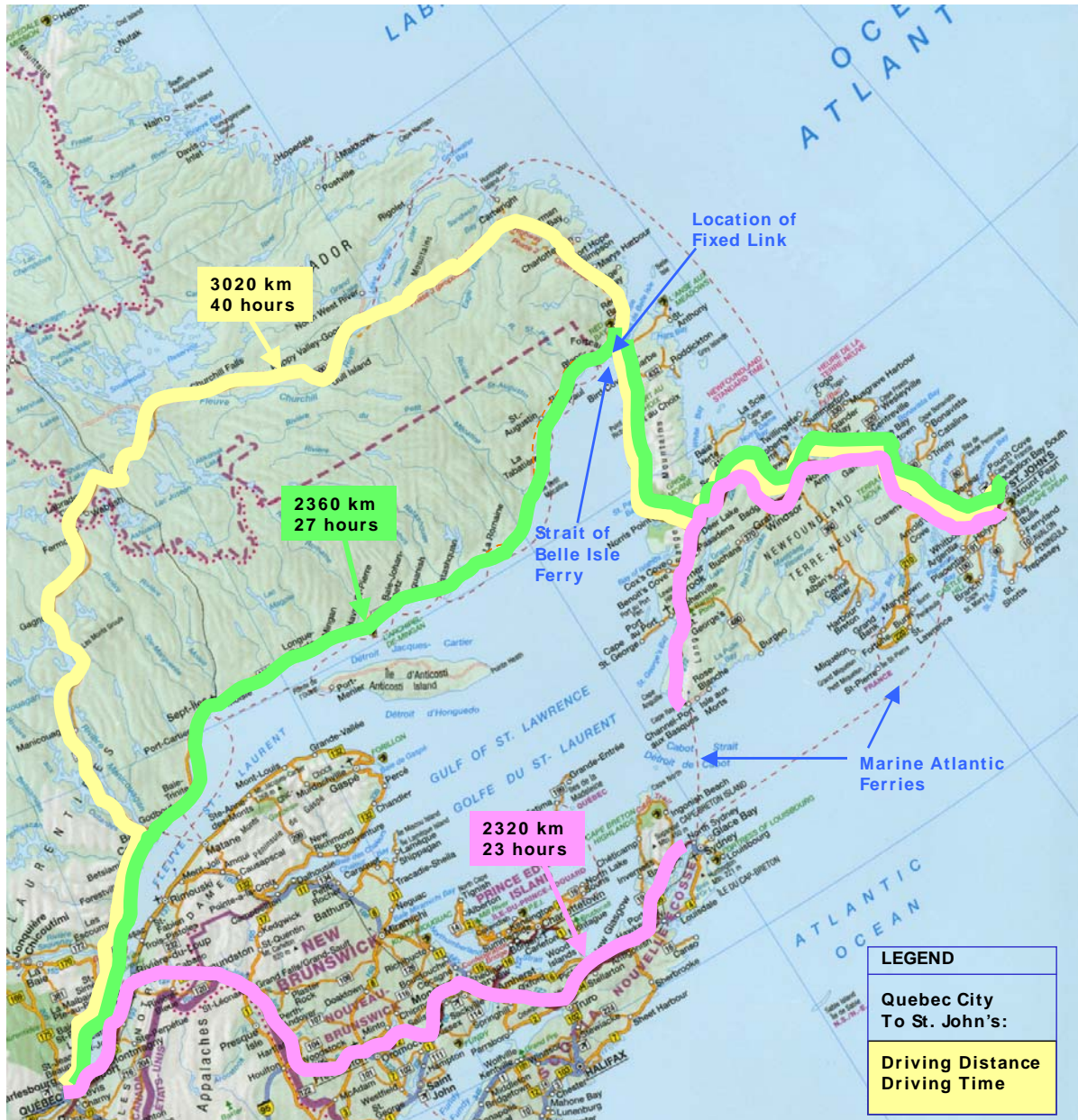

Figure 7.3 Travel Distances

### *Reliability*

Service interruption due to unfavourable ambient conditions (high winds, ice conditions) or vessel repairs is a frequently mentioned concern associated with the Gulf Ferry service. The proposed fixed link will be immune to ambient conditions in the Strait of Belle Isle and from this perspective will provide heightened reliability compared to the Gulf Ferry service.

Winter weather conditions along the north shore of the St. Lawrence and the Great Northern Peninsula are probably worse than those along the Trans-Canada Highway for travel from Quebec to Nova Scotia although detailed inspection of meteorological data and the impact on highway conditions was not carried out for this study. With respect to mechanical interruptions, a fixed link rail tunnel is likely to have a reliability advantage over the ferry.

In total, therefore, a fixed link and connecting roadway accesses would be expected to provide an enhanced level of reliability compared to the existing highway and ferry alternative.

### *Terrain*

Roadway gradients and curvature are significant contributors to operating costs for motorized freight traffic. Steep coastal fjords are present along the North Shore of the St. Lawrence and through parts of the Great Northern Peninsula and, potentially, create a large number of steep inclines/declines. While these conditions are present along the Trans-Canada Highway from Quebec to Deer Lake (notably in the Riviere du Loup to Edmundston and Cape Breton sections) their length is relatively short and mitigation has occurred as a consequence of geometric improvements to the highway. An operating advantage to the existing Gulf Ferry route would occur as a consequence.

### *Weight Limitations*

Restrictions on the Gross Vehicle Weights (GVWs) of trucks are imposed on Canadian highways to reflect vulnerability of underlying roadbeds and/or surface material to heavy loads. These restrictions are frequently implemented during spring operating conditions but can be imposed year round if highway quality dictates. Trans Canada Highway weight limits are generally unrestricted year round. Since the alternative route via the north shore of the St. Lawrence is yet to be constructed, it would be reasonable to expect that weight limits would also be unrestricted on this route.

### *Claims*

Damage to vehicles or cargo is a function of operating conditions and the quality and frequency of handling. Operating conditions along the existing route are considered to be more favourable than on a future route along the north shore of the St. Lawrence and on the Great Northern Peninsula. While this would lend some support to the existing route, one must also consider the impact of vessel loading and marine operating conditions on the Gulf Ferry service. Operating conditions dictate that freight traffic is tied to the vessel deck to prevent damaging movements of vehicles. Drop trailer traffic is also tied down but is loaded and unloaded with yard tractors. Marine Atlantic staff is believed to have a good claims record for these procedures but damage does occur. It is felt that the fixed link route will have a marginal net advantage in claims experience.

### *Competition*

One of the factors affecting utilization of new routing alternatives is the presence and viability of competing means of access. The existing Gulf Ferry service is a constitutional commitment of Canada to the Province of Newfoundland, which is enshrined in the 1949 Terms of Union. Furthermore it serves an important trade corridor that will not disappear with the construction of a fixed link.

There will always be a need for a robust, and likely subsidized, ferry service. The degree of subsidization may be an issue if a fixed link is built. The Gulf Ferry, during 2003, achieved an operating cost recovery of 57.6%. On a total operating budget of \$111.1 million, a federal subsidy of \$43.8 million was required. Pressure to reduce the operating subsidy, and even make a contribution to capital requirements, would likely ensue if a fixed link were constructed.

Increases in rates and reduction of operating costs through efficiencies and/or service level reductions would be targeted but their overall occurrence and degree of such moves would be a matter of government policy. Given that the current rate for moving a 60-foot tractor-trailer and driver across the Gulf Ferry Service is \$284.25 while the comparable rate for the *Apollo* Service is \$161.25 (the assumed rate structure for the fixed link) some price elasticity of demand impacts on the Gulf Ferry service would be expected and are accounted for in the traffic diversion estimates.

Oceanex, in providing service from Montreal and Halifax to St. John's and Corner Brook, is an important player in Newfoundland freight transportation, having some 42% of the market place in 2003. The company has increased the overall volume of traffic moved and its market share during the past five years. In December of 2003, Oceanex announced that it would be purchasing a new 150-metre ice-class container ship to be delivered in 2005. The new vessel will increase weekly capacity from Montreal by some 350 TEU's per week and provide operating efficiencies in the form of fuel savings and a fully automated engine room. The new ship will be designed to handle 53-foot containers and have movable container cell guides to provide maximum operating flexibility for future changes in customer requirements. Oceanex may also increase the frequency of Halifax sailings if they decide to retain the M.V. *Cicero* and thus expand the fleet size from three to four vessels.

The overall likely outcome of the Oceanex capacity addition is that the company will strengthen its competitive position with respect to all existing and contemplated freight options to Newfoundland. The freight traffic forecasts for a fixed link, therefore, contain no diversion of traffic from Oceanex.

Table 7.7 summarizes the discussion on modal share variables that will affect freight shipments to Newfoundland in a fixed link environment.

**Table 7.7 Modal Share Variables and Impacts**

<b>Variable</b>	<b>Fixed Link vs Gulf Ferry Alternative</b>	<b>Conclusion</b>
<b>Driving Distance</b>	Equal distance for Central Canadian traffic but significant advantage to Gulf Ferry for service via Maritimes	Gulf Ferry position is strong for Maritime traffic and neutral for Central Canadian traffic
<b>Travel Time</b>	Operating speeds in favour of Gulf Ferry route and crossing time differentials in favour of fixed link essentially balance out	Neutral
<b>Reliability</b>	Crossing reliability higher for a fixed link but winter highway conditions may be more favourable for Gulf Ferry route	Increased reliability for fixed link
<b>Terrain</b>	More difficult terrain on fixed link route will increase operating costs versus Gulf Ferry Route	Gulf Ferry route is superior
<b>Weight Limitations</b>	Weight restrictions along the Northshore St. Lawrence highway will likely be upgraded to TCH standards	Neutral
<b>Claim</b>	Claims from poor operating conditions along North Shore St. Lawrence highway more than compensated by handling claimed on Gulf Ferry service	Slightly better claims experience with fixed link
<b>Competition</b>	Gulf Ferry service and direct water services will remain with good quality / frequency of service to compete with fixed link	Gulf ferry is more vulnerable than direct water service but will still be a very significant component of future freight service.

#### *7.1.4 Traffic Projections –Upgraded Ferry*

For the upgraded ferry it is important to analyse the practicality of increasing the service. During July and August, the MV *Apollo* presently provides up to three return voyages per day. For a 90 minute crossing and 60 minute turnaround at the terminal, this presents a 13.5 hour operating day. By increasing the operating day to 18 hours, four return voyages are possible. This is considered to be the maximum number of trips for a single ship ferry. An upgraded ferry service would therefore, extend this maximum service level for a longer season and provide service for the rest of the year. The proposed service frequency is presented in Table 7.8, with the existing frequency for comparison.

**Table 7.8 Ferry Service Frequency for Strait of Belle Isle**

	Jan	Feb	Mar	Apr	May	Jun	Jul	Aug	Sep	Oct	Nov	Dec	Total
<b>Trips/Month</b>													
Present	9*	0	0	0	52	52	74	74	56	56	43	19*	435
Upgraded	93	84	93	120	124	120	124	124	120	120	90	93	1305
<b>Trips/Day</b>													
Present	1-2	0	0	0	1-2	1-2	2-3	2-3	1-2	1-2	1-2	1-2	
Upgraded	3	3	3	4	4	4	4	4	4	4	3	3	

\*varies with weather conditions

For the single ship, this level of service would result in scheduled sailings, at 5 hour intervals. Therefore, a traveller would experience a minimum of 2.5 hours travel time for the crossing and a maximum of 7 hours, the latter if the traveller misses or fails to get on a particular sailing.

Projections were developed for a case representing substantial upgrade to the existing ferry services across the Straits of Belle Isle. Cost projections are developed to be representative of extending the operating season for as long as possible (essentially year-round operations for purposes of economic comparison). Ship replacement continuing with a status quo arrangement has been estimated to cost approximately \$75 million (2004 dollars). The costs of an upgraded vessel are not precisely known because the vessel design would depend on service plans. For purposes of this analysis, a conservative estimate with a 100% premium is used. Therefore, approximately \$150 million (2004 dollars) is considered to be the upgraded vessel cost representing a larger Ice Class 1A Ferry or two vessels of equivalent total capacity to offer higher peak frequency, using the same replacement timing as the base case.

The annual subsidy is presumed to double on account of a longer sailing season and increased frequency of sailing. This would represent approximately three times as many departures as at present, mostly occurring in the extended season, although there would be also peak season enhancement. The rationale for this estimate is as follows:

- Subsidy for operating the existing service is \$5.5 million per year (2004 dollars), and the revenues would be approximately \$2 million by year 11, for a total annual operating cost of \$7.5 million;
- It is estimated that 50% of these total costs are variable with the number of voyages, that is \$3.5 million (rough rule-of-thumb for fuel, crew and terminal wages, supplies and repairs);
- Tripling the number of departures would triple these costs to \$10.5 million per year, bringing the total operating cost to \$14.5 million per year (2004 dollars);
- With revenues in the range of \$3.5 million in year 12, the gap that would be met by subsidies would be about \$11 million, or approximately double the present subsidy.



The timing for introduction of service improvements would coincide with completion of the Highway 138 extension to Blanc Sablon, presumably in the same general time frame as is considered for the fixed link construction.

The growth assumptions applicable to the existing traffic base employed for this case are as follows:

- Tourist trips would continue to grow at an annual rate of 3.5% throughout the study time frame;
- Local and residential travel will experience a 15% one-time surge upon introduction of the new service, followed by growth at the rate of 1.5% annually.
- Tourist travel will experience increased annual growth of 0.5% following completion of the highway and introduction of the new service;
- Truck traffic would experience 2% (of total Oceanex and Marine Atlantic, equivalent to 3% of Marine Atlantic) diversion from the Cabot Strait and would continue to grow annually at previously established growth rates.
- Auto traffic would experience a 1% diversion from the Cabot Strait

These assumptions are presented in Table 7.9

**Table 7.9 Traffic Growth Rates for Upgraded Ferry**

% Annual Growth Rates	Existing Ferry	With Upgraded Ferry			
		Continuing Growth	Plus Post Completion Increment		
			One-time effects		Annual Increment to Growth
			Shift	Tunnel Surge	
<b>Strait of Belle Isle</b>					
Tourists	3.5%	3.5%			0.5%
Local and Business	2.2%	1.5%		15.0%	0%
Tractor-trailers	2.5%	2.5%			0%
<b>From Marine Atlantic</b>					
Auto	2.5%		1%	0%	0%
Tractor-trailers	2.5%		3%		0%

This set of assumptions is considered as reliable and appropriate as any other in the absence of detailed market data to test sensitivity to these improvements. The growth rates are reduced from those for the fixed link based on the less attractive level of service and potential delays associated with the upgraded ferry. The results, in terms of annual vehicle trips for passenger cars and trucks, are shown in Figures 7.4 and 7.5.

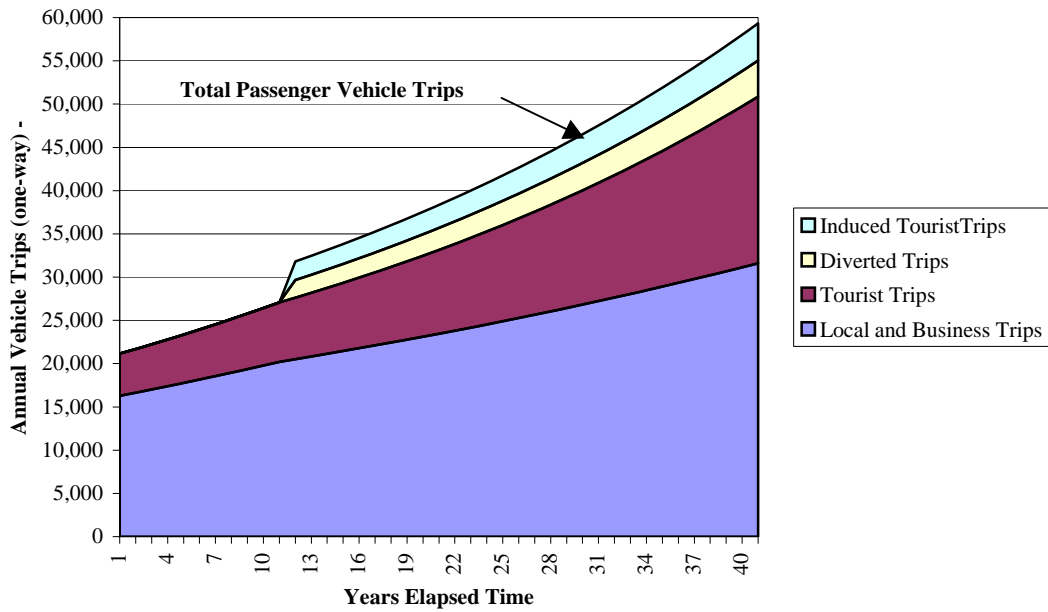

Figure 7.4 Passenger Vehicle Traffic Projections - Upgraded Ferry

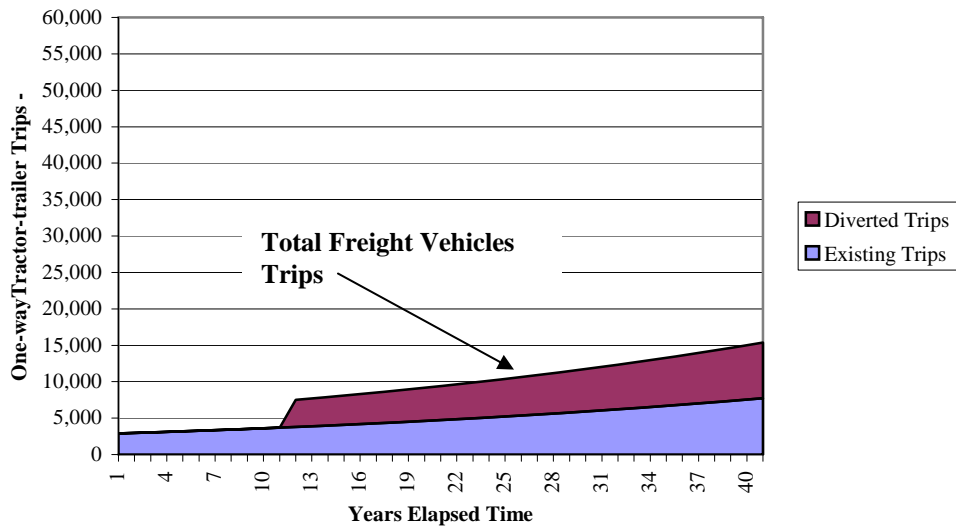

Figure 7.5 Freight Vehicle Traffic Projections - Upgraded Ferry

### 7.2 Tolls and Revenue Forecasts

Revenue forecasts were developed for the three cases noted previously. Revenues were calculated based on existing *Apollo* tolls: \$30.50 per vehicle and driver and \$10 per additional passenger. Freight revenues were based on the existing average revenue per tractor-trailer on the *Apollo*, of \$161.25. The resulting revenue projections for the base case for the study operating period of 30 years are shown on Figure 7.6.

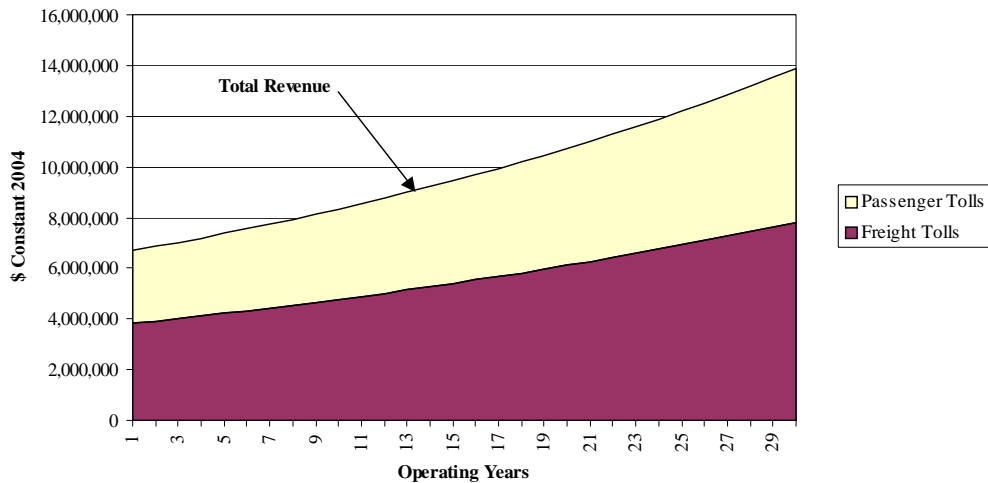

Figure 7.6 Fixed Link Revenue Projections

Similarly, Figure 7.7 shows revenue projections for the case of an upgraded ferry for the same operating period.

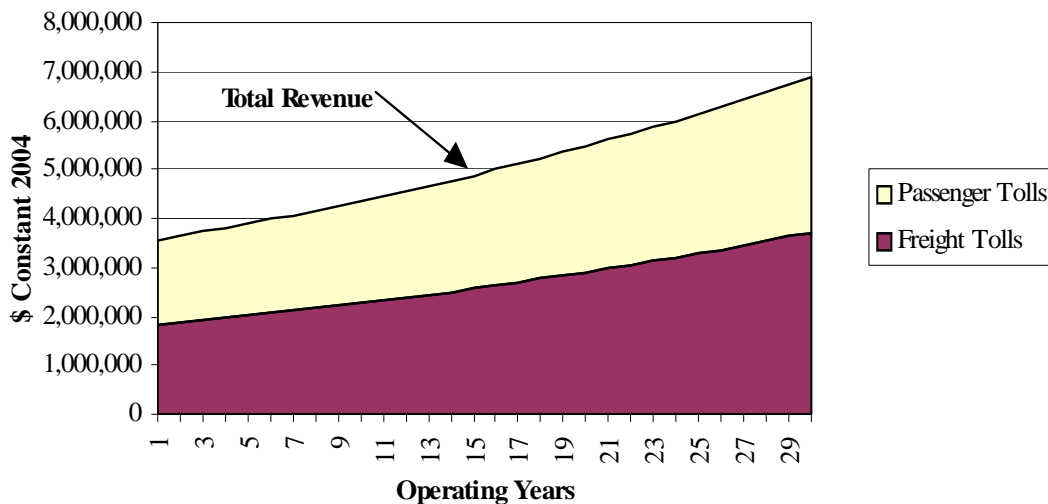

Figure 7.7 Upgraded Ferry Revenue Projections

The third case examined is the Base Case with revenue from HVDC transmission cables within a fixed link. Project cost estimates were developed to include HVDC power cables in the fixed link on behalf of Newfoundland and Labrador Hydro (NLH), as part of a future transmission line between Labrador and the Island. For purposes of the economic analysis, NLH also provided capital cost estimates to install submarine cables across the Strait. These costs would be avoided if the transmission line were to go ahead using the fixed link across the Strait. The incremental capital and operations cost attributable to the HVDC line in the fixed link are virtually insignificant compared to the other costs except for the power cables and their installation. The issue is how to value this opportunity for a power transmission facility. The approach applied to forecasting a reasonable revenue stream was based on the amortization of the avoided capital cost of an HVDC installation in the fixed link versus a dedicated submarine HVDC system over the 30-year time horizon of this study. The range of potential revenue streams considered is as follows:

- Cable cost recovery - that which results in neither incremental cost nor revenue to the tunnel owner – below that, losses would be incurred and be of no interest to the tunnel owner; this would be represented by amortization of the cable installation and annual cable maintenance costs;
- Highest possible revenue - the annualized equivalent of 100% of the costs that would be avoided by NLH by using this facility instead of building a dedicated crossing – higher charges would drive the power utility to a dedicated facility, if the market could support it;
- An intermediate value - revenue that might ultimately be negotiated between the tunnel developers and the utility.

In the absence of a final determination of developing the hydro potential of Labrador and the consequential decision to deliver hydro electricity to the Island of Newfoundland, the outcome of such negotiations is premature to predict at present. Consequently, for purposes of evaluating the revenue impact of hydro transmission, it was considered most reasonable to use a median between the limits and to calculation a case at 50% of the avoided cost of a dedicated hydro link. The upper and lower limits would be checked in sensitivity analyses. In all three cases, the annual fees are based on amortization to null residual value over a period of 30 operating years.

**Table 7.10                      Annual HVDC Revenue Ranges**

<b>\$ Millions (constant 2004)</b>	<b>Lowest Limit</b>	<b>Highest Limit</b>	<b>Mid Point</b>
<b>Recovery of Cable Costs</b>	\$7.1	\$7.1	\$7.1
<b>Transmission Revenue</b>	-	\$34.4	\$17.2
<b>Total</b>	\$7.1	\$41.5	\$24.3

Consequently, the transportation toll revenue would be augmented by a real constant annual amount equivalent to one of the totals shown in Table 7.10, depending upon the case under consideration. For purposes of the analysis, for the Base Case with HVDC income case, \$24.3M per year was used.

### 7.3 Economic Evaluation

Three indicators of economic value are employed for the base case and various sensitivity tests that were conducted. The three indicators are Net Present Value (NPV), Internal Rate of Return (IRR), and Benefit Cost Ratio (BCR). Descriptions of the application of each of these are as follows:

- NPV is calculated using a real social discount rate of 7.5%, which is the recommended rate of the Federal Treasury Board assuming annual inflation at 2.5% over the project time horizon (i.e. 10% nominal). The net cash flow for each year (positive or negative) is discounted to reflect the equivalent value in 2004, and all the years are summed to one total NPV.
- IRR is calculated internally, before cash flows are discounted; it is the effective discount rate that would produce a null NPV.
- BCR is calculated using the same cash flow inputs as the NPV, except activities that are meant to produce benefits are separated from those that are meant to cause cost and are summed independently of each other. The ratio of the summed benefits to the summed costs is the BCR; values greater than one are desirable and suggest economic justification; values less than one are undesirable but not necessarily conclusive in themselves, without taking into account external factors that are not quantified in the analysis.

Each of the three indicators was estimated in accordance with three distinct perspectives for each case studied. The perspectives depend upon the nature of the observer (private investor, lending institution, government, etc.) and they reflect increasing scope from a strictly internal cash-flow perspective to a broader socio-economic context. The three levels are:

- **Internal revenues and costs** for planning, design, construction and operation of the tunnel – this would be the most appropriate perspective for a proponent considering stand-alone development and exploitation of the project;
- **Economic impacts** directly attributable to the fixed link, such as changes to the revenues and costs of existing marine ferries in the Cabot and Belle Isle Straits, and it would include some external effects such as environmental mitigation, safety enhancement, reduced delays and congestion etc. (which are estimated to be insignificant in this case) – this would be an appropriate perspective for a transportation economist to use to estimate net effects on the industry or on subsidies;
- **Socio-economic impacts** include consequential stimulation of GDP growth in the province from the activity of construction and subsequent tourism and other activities, and other externalities that might include quality of life improvements that could be estimated – these estimates are macro-economic in nature and tend to be used as public policy indicators; they are difficult to measure in small scale systems because data are rarely available; in this study, aggregate indicators used by the Newfoundland Department of Finance were provided to the team.

#### 7.3.1 Internal Revenues and Costs

The profile of cash outflows over 30 years of operations for the base case after construction is completed is illustrated in Figure 7.8. In constant currency terms, the costs are uniform for a fixed level of operation except for periodic major maintenance consisting of major equipment replacement shown as peaks in years 7, 12, 16, 20, 25 and 30.

During the study, it was determined that the shuttle operation could be commissioned incrementally to match the development of traffic. This refinement has not been incorporated into the analysis. The full fleet is assumed in the first year of operation.

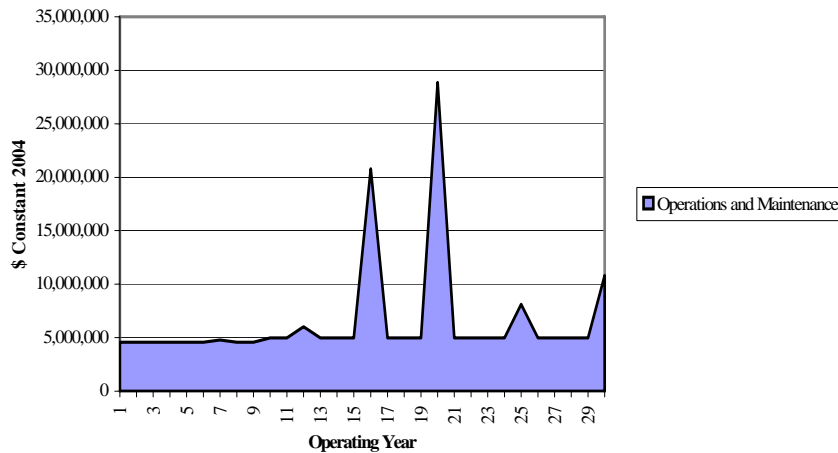

Figure 7.8 Costs by Operating Year

Figure 7.9 shows the effect of combining the revenue and costs from Figures 7.6 and 7.8 and converting the resulting cash flow to present value for the Base Case.

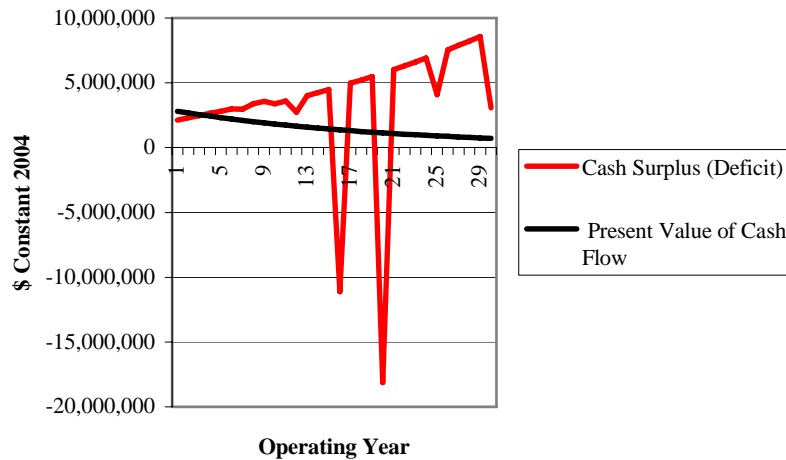

Figure 7.9 Operating Cash Flow in 2004 dollars

The upper red line in figure 7.9 represents the net result of subtracting the operating costs from the base case revenues and the lower black line represents those same values discounted to present value at 2004, considering also that year 1 in the graph is actually year 12 in the project life cycle. The effect of long time frames in a project of this nature are clearly evident in the gap between the two lines in Figure 7.9.

7.3.2 Present Value Analysis for Base Case

For the Base Case, project economics are presented for the entire project life cycle assuming an 11 year period of planning, design and construction and 30 year period of operation. Figure 7.10 presents the annual present values in 2004 dollars for the internal economics of the project. Figure 7.11 modifies these annual values by including the economic effects of avoidance of the present Strait of Belle Isle ferry operating deficit costs and minor adjustments that would result to the Gulf Ferry costs. Figure 7.12 further modifies the annual values by including the social benefits in terms of increased economic activity that may be caused by the project.

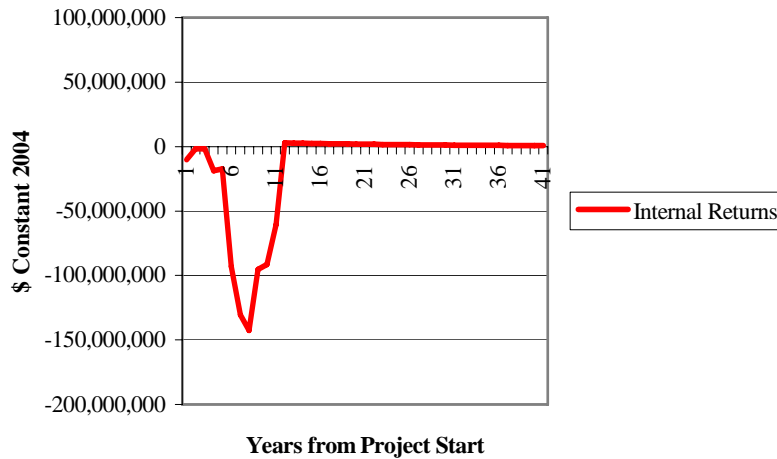

Figure 7.10 Annual Net Present Values (Internal Returns) Base Case

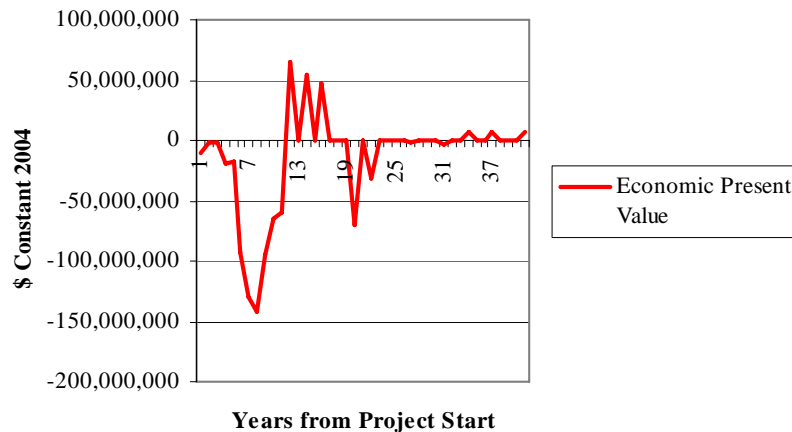
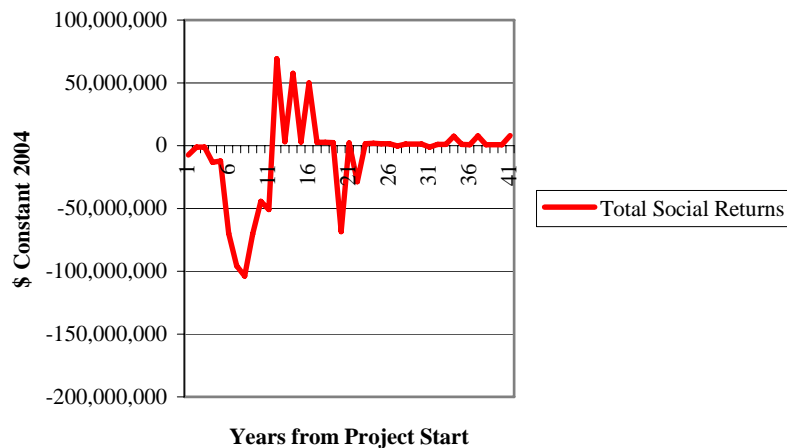

Figure 7.11 Annual Net Present Values (with Economic Returns) Base Case



**Figure 7.12 Annual Net Present Values (with Social Returns) Base Case**

The capital development costs are shown, in Figures 7.10, 7.11 and 7.12, as negative amounts occurring in years 1 through 11. Since these occur early in the time frame, they are not so heavily discounted as the revenue stream, which does not start until much later. The economic present value graph, Figure 7.11, also includes the impacts on Marine Atlantic and the avoided costs of replacing the *Apollo*. Deferral and avoidance of ship replacements account for all of the positive peaks appearing post year 12. The ship replacement assumptions are the critical drivers of the external economic benefits. These assumptions would have to be reviewed, particularly with Marine Atlantic, in light of the actual projected timing of events if there is a decision to proceed further.

The projected economic impacts of tourism development, GDP stimulation and employment during construction are combined with the other benefits and shown in Figure 7.12. While these are significant in themselves, when discounted over a long period of time and compared with the scale of the costs of the project, they show up as minor. One exception occurs in the early years in which the GDP impacts of indirect and induced economic activity during construction offsets in part the impact of the costs.

The direct, indirect and induced impacts on GDP, wages and employment were determined using information provided by the Newfoundland and Labrador Department of Finance. The approach used is to split the impacts into direct, indirect and induced. Direct investment, labour income and employment information was provided by the project team. The indirect impacts (which are impacts generated when companies supply inputs to the direct activity) use indirect multipliers for standard industries generated from Economic Input/Output data. The induced impacts (which are impacts generated when direct and indirect employees and business owners spend their earnings in the general economy) are estimated using a multiplier of 0.3, but for employment this may need to be adjusted up or down depending on the average wage rates in direct and indirect industries. For example, the 0.3 induced impact is the average for the entire economy, but if the average wage in the direct and indirect industries is twice the average wage in the entire economy then more money will most likely be spent per direct and indirect employee and the induced impacts are larger. In this case we would use an induced employment multiplier of 0.6. If the direct and indirect wage rates were half the economy average one would use an induced multiplier of 0.15.

Specifically, in this project, and based on communications with the Department of Finance, the following parameters were selected:



**For Construction:**

Since the Transportation Engineering Construction industry is the industry which most closely resembles tunnel construction its parameters were used. For estimating direct effects, data for 2000 puts the GDP to gross output ratio at 34%, the labour income to gross output ratio at 22% and the employment per \$1 million of expenditure/gross output at 6 full time equivalent jobs. To estimate the indirect impacts the following multipliers were averaged over the 1997 to 2000 period:

- ♦ GDP 0.63
- ♦ Labour income 0.53
- ♦ Employment 0.63.

The induced multiplier of 0.3 is applied to the direct and indirect impacts. (This is based on average annual labour income per person year (full year equivalent) of employment in 2003 at \$35,200, calculated by dividing Labour Force Survey employment into total labour income from Statistics Canada Provincial Economic Accounts).

**For Tunnel Operation:**

Since the Rail Transportation is the industry that most closely resembles tunnel operation its parameters were used. To estimate the indirect impacts the following multipliers were used for rail transportation; they are averaged over the 1997 to 2000 period.

- ♦ GDP 0.28
- ♦ Labour income 0.85
- ♦ Employment 0.71.
- ♦ Induced multiplier 0.3.

**For Tourism:**

While data are available for auto and air tourism impacts, the travel information concerning the target market is sparse, and the time frame is relatively far out in the future so that composite industry assumptions are used. Based on 1998 spending Department of Finance came up with the following estimates of the direct impacts from non-resident tourist spending (excluding spending on marine transportation).

- ♦ Direct GDP 0.35
- ♦ Direct labour income 0.24
- ♦ Direct employment per \$1 million, 12.8 full time equivalent jobs

The indirect multipliers are:

- ♦ GDP 0.44
- ♦ Labour income 0.33
- ♦ Employment 0.24.
- ♦ Induced multiplier 0.15.

**7.3.3 Present Value Analysis for the Upgraded Ferry**

For the upgraded ferry, the project economics are presented for the entire life cycle of the project assuming the implementation of the new service at year 12. Figure 7.13 present the annual net present values in 2004

dollars for the internal economics of the project. The negative peak at year 10 indicates the vessel acquisition the peak at year 40 shows the vessel replacement. Figure 7.14 modifies these annual net present values by including the economic effects of avoidance of the present ferry operating deficit costs. Figure 7.15 further modifies the annual net present values by including the social benefits in terms of increased economic activity that may be caused by the project. It should be noted that the social benefits associated with this case are relatively small.

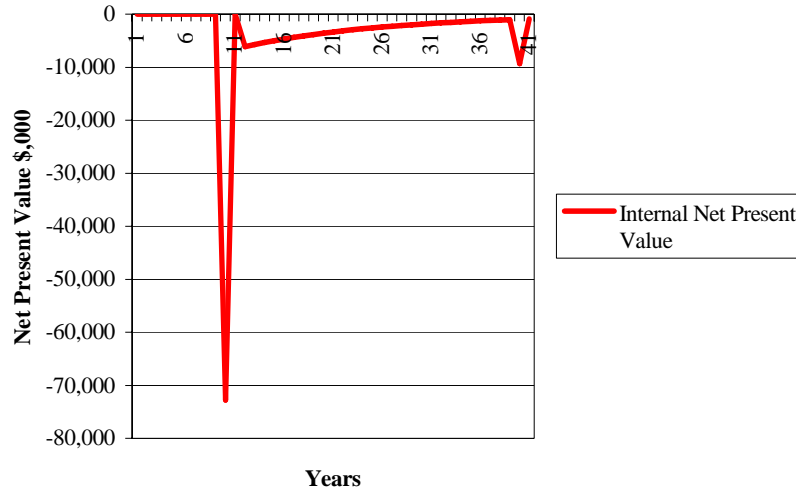

Figure 7.13 Annual Net Present Values (Internal Returns) Upgraded Ferry

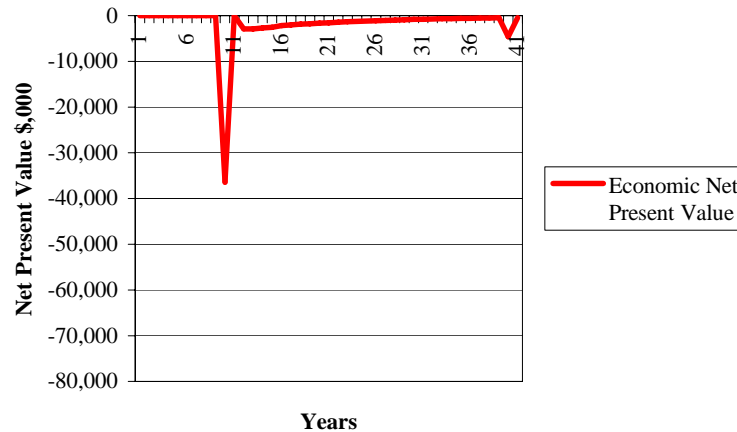
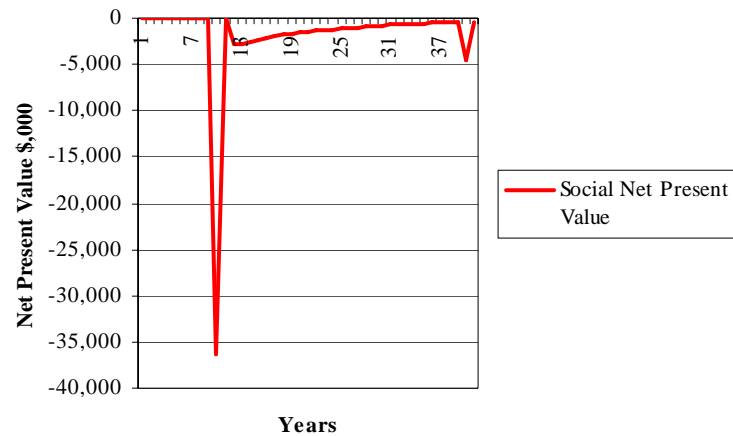

Figure 7.14 Annual Net Present Values (with Economic Returns) Upgrade Ferry



**Figure 7.15 Annual Net Present Values (with Social Returns) Upgraded Ferry**

*7.3.4 Results of Economic Analyses*

The results of applying the method outlined above to each case are shown in Table 7.11. The Internal Returns section of the table refers to the recovery of the fixed link or upgraded ferry investment and recovery of the capital investment (i.e. costs) from the operating benefits – cash flow from operations.

The Base Case and the HVDC Case have both positive and negative cash flow so all three measures are applied for comparison purposes (NPV, IRR and BCR). The Ferry Upgrade does not have any years with positive cash flow therefore IRR cannot be calculated. Results are shown in Table 7.11.

**Table 7.11 Economic Evaluation Results**

LEVEL	CASE	NPV	IRR	BCR
		\$ millions 2004	%	#
Internal Returns	BASE CASE	-\$648	-9.5%	0.07
	HVDC	-\$554	-2.1%	0.25
	FERRY UPGRADE	-\$164	N/A	0.13
Internal Returns & Economic Returns	BASE CASE	-\$559	-5.2%	0.20
	HVDC	-\$466	-1.0%	0.37
	FERRY UPGRADE	-\$116	N/A	0.38
Internal Returns & Economic Returns & Social Returns	BASE CASE	-\$333	-1.3%	0.53
	HVDC	-\$240	1.6%	0.68
	FERRY UPGRADE	-\$114	N/A	0.39

The following observations apply to Table 7.11:

- The NPVs are all negative - this clearly places every alternative in the realm of the public sector because quantifiable benefits are insufficient to sustain viability.
- Including HVDC in the fixed link improves all indicators and improves the NPV by \$94 million (at 50% sharing of avoidable cost). At 100% of the avoidable cost, the NPV would improve by a further \$84 million.
- Upgrading the Strait of Belle Isle ferry service is significantly less costly compared to the base case – the NPV for Economic Returns is negative \$116 million. The negative \$116 million NPV results from increases to annual subsidies for the ferry, plus Marine Atlantic loss increases resulting from revenue diversion, plus ship replacement.
- The Benefit Cost Ratios (BCR) are all substantially less than unity – suggesting that project justification, if pursued would have to depend on factors that are external to this study, e.g. consequences of electrical energy transmission, social and political considerations associated with uniting the Province with a physical link.
- The difference between internal cash flows and economic impacts generates an improvement in NPV around \$89 million
- The Social Returns for the Base Case, which include GDP growth effects of incremental tourism and activity stimulated by construction of the fixed link generate additional impacts around \$226 million NPV (\$2004 dollars).

Figures 7.16, 7.17 & 7.18 show the data presented in Table 7.11 in graphical form for ease of comparison.

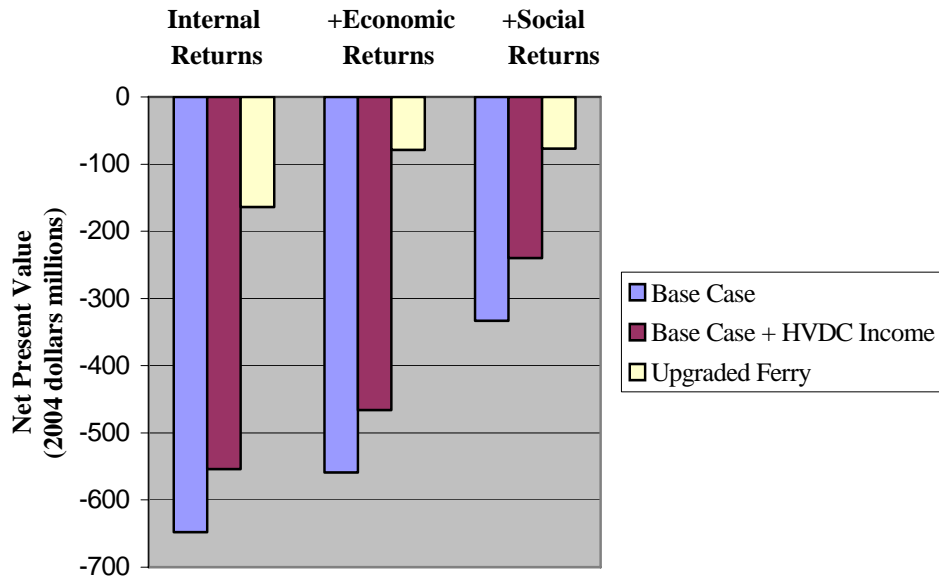

Figure 7.16 Net Present Values for Each Study Case

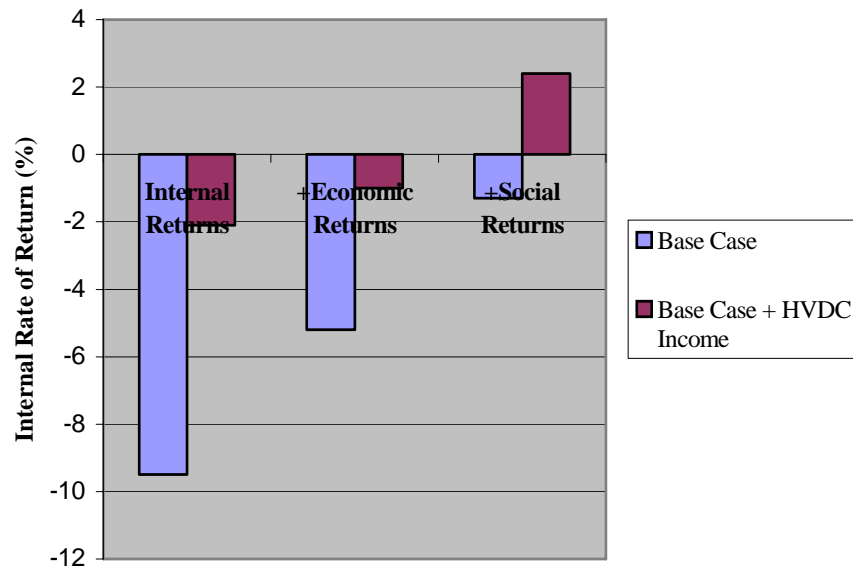
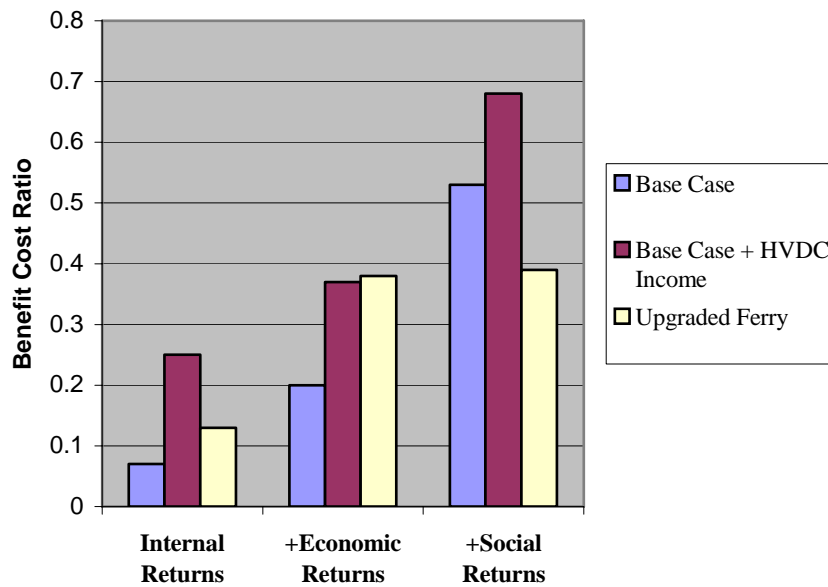

Figure 7.17 Internal Rates of Return for Each Study Case (where calculable)



**Figure 7.18 Benefit/Cost Returns for Each Study Case**

In addition to the analyses described above, various sensitivity tests were carried out to determine if these findings are sufficiently robust and to support overall project conclusions. The sensitivity to electricity transmission tolls is significant, as mentioned above. Toll revenues for freight and passenger vehicles were also tested.

Table 7.12 below shows the results for a range of variation in toll revenues for the base case demand levels. For example, doubling the tolls with inelastic demand could have the effect of improving NPV by \$46 million and increasing the Internal BCR from 0.07 to 0.14. The absence of reliable market information at this time precludes delving further into this topic. Demand factors and elasticity to tolls should be examined much more closely, particularly in the years approaching tunnel completion.

**Table 7.12 Economic Sensitivity Analysis to Toll Revenue**

		<b>Unit Toll % of Base Case Value</b>			
<b>Results</b>		<b>Base Case</b>	<b>50%</b>	<b>150%</b>	<b>200%</b>
<b>Internal Project Revenues and Costs</b>	NPV \$millions	-\$648	-\$671	-\$625	-\$602
	IRR	-9.53%	N/A	-6.60%	-4.84%
	BCR	0.07	0.03	0.10	0.13
<b>Economic Impacts</b>	NPV \$millions	-\$559	-\$582	-\$536	-\$513
	IRR%	-5.28%	-6.66%	-4.11%	-3.09%
	BCR	0.19	0.16	0.23	0.26
<b>Socio-Economic Impacts</b>	NPV \$millions	-\$333	-\$356	-\$310	-\$288
	IRR	-1.4%	-2.5%	-0.4%	-0.4%
	BCR	0.52	0.49	0.55	0.59

Variations in traffic growth rates for different segments(e.g. local and business travelers, diverted tourists and induced travel) were evaluated. No major impacts were observed. In general, the range of change in NPV attributable to market variations is less than 10% of the base case over the maximum extent of the range, as reflected in Table 7.13.

**Table 7.13 Traffic and Cost Sensitivity Analyses**

<b>Description</b>	<b>Range Tested</b>	<b>NPV Range \$MM</b>	<b>NPV Range/Base Case</b>
Toll Rates	50–200% of Base Case	69	11%
Diversion ex Cabot	0-15%	44	7%
Incremental Growth Rate	2.5-7.5%	20	3%
Operating Costs	50-200% of Base Case	46	7%
Capital Costs	70-130% of Base Case	398	61%

Operating and capital costs were also considered. Capital costs were tested over the design range of accuracy of the estimates for this pre-feasibility study (i.e. plus/minus 30%), as also shown in Table 7.13. Clearly, the results are very sensitive to capital costs and accuracy of cost estimates represents a significant risk factor going forward.

With respect to the upgraded ferry option, the significant factor is vessel replacement cost. If the actual vessel cost were \$100 million, instead of \$150 million, then the overall impact on NPV would be \$27 million ( 2004

dollars). That is the NPV for Economic Impacts would be negative \$52 million instead of negative \$79 million.

Operating cost projection uncertainty is not very significant relative to capital cost. Over a range of half to double the base case value, the total impact is only 7% of the base case NPV. These costs are planning details that would have to be considered more thoroughly in a full feasibility study and operating plan, however they do not affect the general thrust of the findings in this report.

**Table 7.14 Discount and Inflation Rate Sensitivity Analysis**

Results		Nominal Social Discount Rate					Inflation Rate			
		4.0%	6.0%	8.0%	10.0%	12.0%	1.0%	2.0%	4.0%	5.5%
Operating Cash Flow	NPV \$MM	-\$985	-\$858	-\$746	-\$648	-\$564	-\$584	-\$626	-\$720	-\$800
	IRR %	-9.53%	-9.53%	-9.53%	-9.53%	-9.53%	-9.53%	-9.53%	-9.53%	-9.53%
	BCR	0.17	0.12	0.09	0.07	0.05	0.05	0.06	0.08	0.10
Direct Economic Impact	NPC \$MM	-\$829	-\$737	-\$644	-\$559	-\$486	-\$503	-\$540	-\$621	-\$690
	IRR %	-5.28%	-5.28%	-5.28%	-5.28%	-5.28%	-5.28%	-5.28%	-5.28%	-5.28%
	BCR	0.30	0.24	0.21	0.19	0.18	0.18	0.19	0.21	0.23
With Indirect and Induced Impacts	NPV \$MM	-\$325	-\$367	-\$359	-\$333	-\$302	-\$310	-\$326	-\$354	-\$367
	IRR %	-1.42%	-1.42%	-1.42%	-1.42%	-1.42%	-1.42%	-1.42%	-1.42%	-1.42%
	BCR	0.72	0.62	0.56	0.52	0.49	0.50	0.51	0.55	0.59

Sensitivity to the social discount rate and to projected inflation is significant also. Table 7.14 illustrates results for comparison to the base case (Nominal discount rate – 10%, Inflation rate 2.5%). Higher discount rates improve the NPV and diminish the BCR because the front end costs are so high compared to the downstream benefits. A range of plus/minus 2% around the base case causes the NPV range to extend over 15% of the base case amount. This is a significant variation.

The inflation rate also is significant, and along with capital costs, represent the most significant risk factors in economic terms. The difference between 1% and 4% inflation is \$217 million in terms of net present value or 33% of the base case NPV.

Finally, significant spikes in the costs and benefits are noted when the vessels in existing ferry services to the Island of Newfoundland need to be replaced, or additions to the fleet are required. The timing of these events have a more significant impact than variations to internal revenues or costs after the tunnel is operating. Further, these events can happen throughout the entire project lifecycle, especially in years prior to start up of revenues. A full feasibility study of the tunnel would require coordinated planning approach involving Marine Atlantic (with respect to funding decisions) and the existing ferry services to Labrador (with respect to both subsidies and funding ship replacement).

If Highway 138 were not completed, then it would be reasonable to compare the base case to a case with neither diversion nor incremental/induced growth, but with traditional growth levels sustained. In such a case the NPV would be reduced another \$170 million. The consequential mitigation of negative value would be modest. In other words, without completion of Highway 138 to the tunnel entrance, in the same time frame as the tunnel is built, the Net Present Value of the tunnel project would be \$170 million lower than with the highway. This is a major risk factor that would be removed with a commitment to complete Highway 138.



In summary, the major risk factors emerging from the sensitivity analysis are uncertainty in development and construction costs (not an unusual occurrence at this stage of considering a major infrastructure undertaking), uncertainty regarding completion of Highway 138 on the St. Lawrence Lower North Shore, and, to a lesser extent, inflation.

Employment impacts were also determined for each case described above. There is not much variation between the cases, and the overall impacts are summarized as follows:

- Employment during construction is around 350-500 Full Time Equivalent (FTE) jobs for 6 years
- 40 new permanent jobs for operations & maintenance, replacing the part-time ferry

Total employment impact including spin-off effects

- 1,000 FTE (approx.) during construction (6 years)
- 350 FTE initially on start-up, growing to 550 FTE over 30 years
- Net Present Value of all wages \$400 million

A further sensitivity analysis was carried out for the ferry upgrade option in which the upgraded ferry is introduced at year 5, instead of year 11 to match the fixed link, as assumed in the previous analysis. This has the effect of increasing the size of the economic negative net present value from negative \$79M to negative \$84M as the costs are incurred earlier. This option does, however, provide the improved service at an earlier date than for the fixed link.

## 8 FINANCING CONSIDERATIONS & FINANCIAL ANALYSIS

### 8.1 Financing Considerations

Governments have traditionally invested directly in roads and transit systems, and operated them as part of government. However, since the early 1990's, many governments have adopted models where the private sector funds, designs, builds, and operates roadways and transit systems. This practice is widespread in England, Australia, New Zealand, and Asia, and is becoming more common in North America. The Government of Canada has also demonstrated a growing interest in shared financing over the last decade.

#### *Public Infrastructure Financing Alternatives*

Public Private Partnerships (PPP's) permit Governments to finance development of public infrastructure and provision of public services through access to private capital markets. With the application of PPP's increasing over the last decade, they are now widely acknowledged by both the private and public sectors as a way of drawing on the expertise of both groups to provide a long-term mutual benefit.

Governments have implemented PPP's throughout the world under a variety of different models with a variety of different names. A recurring theme in these initiatives is to avoid having to increase the level of public sector debt.

The rationale for a public-private partnership usually results from:

- ♦ a shortage of government funds
- ♦ a desire to obtain the benefits of private sector project management;
- ♦ transfer of risks to private companies; and
- ♦ greater flexibility in management and efficiency in operations enjoyed by the private sector.
- ♦ Increase level of 'user pays' in the community

International experience has proven that the involvement of the private sector in the delivery of public infrastructure can deliver value for money through the transfer of risk, particularly the risk associated with ridership levels, innovation, and project delivery responsibility.

Other benefits of the PPP include:

- ♦ Commercialisation of revenues: the private sector often focuses on developing commercial opportunities associated with the project.
- ♦ Access to capital: Government funds are usually limited. PPP's provide an alternative funding source.
- ♦ Accountability and on-time delivery: PPP's allow the Government to penalize the private sector when they do not meet the contracted timeline or budget.
- ♦ Cost of funds: the cost of the private sector funds reflect the full risk associated with the project.

There are many models which may be adopted for the implementation of a PPP. At one end, the private sector may provide all or most of the funding, and absorb major risks associated with the project – construction costs, delays, lower than projected revenue, higher than expected operating costs. At the other, the private sector's role may be limited to designing and building a facility within broadly specified

parameters and operating for a fixed income. In the middle, a private contractor may take the risks of design, construction, and schedule, but be guaranteed revenues sufficient to cover the bid cost of the project and subsequent operations.

In determining the appropriate scope and structure of the PPP for the particular project Government's must consider:

- ♦ What is the preferred delivery option, i.e. the bundling of different elements of project delivery into a single contract.
- ♦ What physical and functional components of the project are to be under private sector ownership and control, i.e. stations; infrastructure; rolling stock; and
- ♦ What network components are included in the PPP, i.e. the airport and commuter elements of the project and the existing system.

Table 8.1 summarizes a number of examples of transportation infrastructure finance through public private partnerships.

**Table 8.1 - Example Transportation Infrastructure PPP Projects**

Project	Comments
Confederation Bridge (Prince Edward Island/ New Brunswick) (1987)	<ul style="list-style-type: none"> <li>• New 12.9 km fixed link bridge over Northumberland Strait between PEI and New Brunswick - \$1 billion in direct construction costs</li> <li>• In response to three unsolicited bids for bridge-tunnel solution in 1985- 1986, Federal Government issued a Request for Expressions of Interest in 1987 seeking innovative designs that would provide long-term fixed link</li> <li>• 35-year agreement for the design, build, financing and maintenance of the Confederation Bridge awarded in 1993. At end of contract, bridge transferred to Government for \$1. Construction completed in 1997</li> <li>• Government pays annual lease payment of \$41.9M (1992 dollars) escalated at 75% of CPI – equal to previous ferry subsidy. Operators able to collect tolls. Lease payments securitised for \$660 million and toll revenues for \$328 million</li> </ul>
Charleswood Bridge (Manitoba) 1994	<ul style="list-style-type: none"> <li>• New 152 metre bridge over Winnipeg’s Assiniboine River (and associated roadworks) – \$15M in capital costs</li> <li>• Bridge awarded on a design, build, finance, own, maintain, transfer basis – City of Winnipeg to make annual ascending lease payments under a 30-year lease</li> </ul>
Highway 104 (Nova Scotia) (1997)	<ul style="list-style-type: none"> <li>• Province needed to build a safe 45-km by-pass on the TransCanada Highway (the Cobequid Pass) faster than would be possible with public sector delivery.</li> <li>• Design, build operate (toll system) awarded – project built for \$113M</li> <li>• Off-balance-sheet financing of not-for-profit entity responsible for collecting tolls, operations and maintenance. Federal/Provincial Governments each contributed \$27.5M and \$5.5M of subordinated debt was provided by the Sydney Steel Corporation pension fund</li> </ul>
Highway 407 (Ontario) (1993 and 1999)	<ul style="list-style-type: none"> <li>• In 1993 the Province issued an RFP seeking mechanisms to build the 69- km highway more quickly, cheaply and with lower risk to the taxpayer.</li> <li>• Highway 407 Central was to be designed, built, financed by toll revenues, operated and maintained by the successful bidder over a 35 year concession period. Province later modified the franchise to a design, build, operate and transfer scheme with the financing responsibility retained by the government. This meant that the financing, traffic and revenue risks remained with the government.</li> <li>• In 1999, the Province sold a 99-year concession for Highway 407 central, together with the right/obligation to make 39-km of extensions for \$3.1B.</li> </ul>
The Channel Tunnel (France and England) (1987)	<ul style="list-style-type: none"> <li>• The Channel Tunnel is a unique case and in many respects not typical of private project finance. The operator was at arm’s length from the construction companies which wanted to build the tunnel and the banks who wanted to finance it.</li> <li>• Due to the complexity of the project, Eurotunnel let a design and build contract to the original construction companies operating as a joint venture.</li> <li>• The original estimated total cost was of the order of €7.5 billion in 1987 prices, with almost half of this sum to be provided by equity capital and the rest by loans. The total cost increased progressively during construction to over €16 billion.</li> <li>• Most of the additional cost was covered by additional loans, although some dilution of the equity has taken place through rights issues and some debt for equity swaps as the company struggled to meet its debt charges. The governments agreed to successive increases in the length of the concession, from an initial 55 years to an eventual 99 years.</li> </ul>
Other examples of infrastructures financed through PPP / and Potential new projects	<ul style="list-style-type: none"> <li>• New Brunswick toll highway</li> <li>• French, Spanish, Australian toll-ways</li> <li>• RailTrack in UK</li> <li>• Winnipeg Red River diversion canal</li> <li>• Lower Mainland port/rail infrastructure improvements / expansion. Gateway Transportation strategy and RAV line (potential projects)</li> <li>• Detroit - Windsor tunnel</li> <li>• Peace Bridge expansion (Fort Erie-Buffalo)</li> </ul>

### Private Finance and Risk Transference

Privately financed infrastructure faces three main types of risk: construction risk, revenue and maintenance risk and planning and political risk. Construction risks arise because of the individuality of large infrastructure projects and their long gestation periods, both of which make costs difficult to estimate accurately.

Once infrastructure is completed, infrastructure providers also face operational risks. Where usage is below that expected there may be revenue risks. Finally, and most difficult to assess, are the policy and planning risks which any infrastructure provider has to take into account. The long gestation periods and the longevity of payback periods for major projects makes them vulnerable to changes of policy. Table 8.2 summarizes risk types and risk allocation.

As a consequence of the inherited risks of building and managing new infrastructure, private finance usually demands an equity return calculated by determining an appropriate risk premium above a forecast risk-free rate. Risk premiums are generally set by regulator entities. In Canada this risk premium has historically ranged between 3% and 5%.

**Table 8.2 - Risk Type and Possible Risk Allocation** <sup>2</sup>

	Public Sector	Builder	Operator	Private Lender	Private Owner
Approval Process	X				
Development		X			X
Design		X		O	
Construction		X		O	X
Operation			X	O	X
Maintenance			X		X
Demand			X	O	X
Revenue			O	O	X
Interest Rate				O	X
Exchange Rate				O	X
Inflation				O	X
Taxation					X
Environmental	X	O			O
Regulatory / Political	X			O	X
Injury / Damage	O	X	X		X
Residual Value				O	X
Obsolescence			O		X
Legacy Defects	X	O	O	O	O
(i.e. Polluted Site)	X: Principal risk taker		O: Secondary risk taker		

<sup>2</sup> British Columbia Investing Management Corporation, *Infrastructure Investing*, Nov 2003.

All of these factors are present in the present situation.

### *Capital Markets - Expectations*

Canadian investment managers expect equity markets to stay the course in 2004 and expect equities to outperform bonds according to Mercer Investment Consulting 2004 Canadian Fearless Forecast.

For 2004, the investment managers forecast equity returns to be in the range of 8% to 12%, with Canadian small capital and emerging markets cited as the most favourable markets. For bond and cash markets, the managers expect more modest returns ranging from 2.8% to 4.5%. For the Canadian equity market, the managers predict the material, energy, and financial sectors to be the top performers.

Looking further down the road, the Canadian investment managers forecast 5-year median equity returns to be in the range of 8% per annum to 10% per annum, while bond and cash markets are forecast to be in a more modest range of 3.4% per annum to 5.5% per annum.

Government of Canada Bonds offer attractive returns and are fully guaranteed by the federal government. They are available for terms of one to 30 years and like T-Bills, are essentially risk-free if held to maturity. Currently 5 to 10 year Government of Canada Marketable Bonds average yield is around 4.80%, the yield for more than 10 years bonds is around 5.41%<sup>3</sup>. Standard and Poor's, Moody's and DBRS rate AAA Stable Canada's long-Term Domestic and Foreign Debt<sup>4</sup>.

Canada's Provincial Governments bonds offer high quality and better rates than similar Government of Canada bonds. They pay a guaranteed, fixed level of interest income and are also available for terms from one to 30 years. Provincial Bonds issues are typically expressed as a spread over the Government of Canada bond yields. Some five-year provincial bonds yield 4.17%, nine-year 4.97%, eleven-year 5.11% and 25-year 5.51%<sup>5</sup>. In 1999, Standard and Poor's upgraded Newfoundland and Labrador's long term issuer credit rating to A minus from triple B plus.

The Standard and Poor's also upgraded its long-term senior debt ratings on the Province and on Newfoundland and Labrador Hydro (NLH) to A minus. NLH has consistently issued bonds in the last decades. NLH's bonds issued between 1989 to 1992 yield 10.25%, and bonds issued after 1992 yield between 5.05% and 8.40% depending on their year of maturity.

Newfoundland and Labrador's GDP growth was taken into consideration for the rating upgrade established by Standard and Poor's. In the next couple of years, Newfoundland and Labrador's GDP is expected to continue growing at a slower pace<sup>6</sup>. This upgrade enhances the ability of the province, and its Crown corporations, to access the financial markets on more favourable terms and at lower interest rates. Among other indicators Newfoundland inflation is expected to increase at some 1.9% annually until year 2007<sup>7</sup>.

---

<sup>3</sup> Bank of Canada

<sup>4</sup> Department of Finance Canada

<sup>5</sup> Edward Jones Investments: <http://www.edwardjones.com>

<sup>6</sup> Newfoundland and Labrador Department of Finance

<sup>7</sup> Newfoundland and Labrador Department of Finance

## 8.2 Financial Analysis

### *Selection of Key Target Parameters*

Based on the preceding discussion, the following key parameters are selected for use in the financial analysis.

The long-term inflation rate of 2.5%, and nominal and real social discount rates of 10% and 7.5% respectively have been introduced previously and employed in the economic analysis reported previously.

For purposes of examining debt financing, the rate employed for the base case is 8% real (10.5% nominal), to be applied in amortization calculations over the operating life of 30 years, and including a risk premium because of the nature of the project. Short-term debt to finance construction work is estimated on the basis of 5%.

From the discussion above, if the project were to involve equity participation, then an acceptable long-term equity return would be 22.5% pre-tax. This is based on after-tax return on equity of 13.5% (high end, with risk premium), assuming an effective corporate tax rate of 40%. If a project were to be financed 25% with equity, then the blended target rate of return would be 13.5%. If the debt rate were to be reduced by 2%, then the blended target rate of return would drop to 12%.

At this pre-feasibility stage of the project, it is considered that these parameters are more or less in line with the risk and reward expectations of prospective investors. In other words, internal rates of return below 12% are not likely to attract private capital without significant external favourable considerations.

It is clear that the project in its entirety is incapable of even approaching this target. However this is useful to keep in mind in respect of a strategy that would segment the costs and risks to privatize a portion of the project. For example, if the project were to be built with public financing, then the operation could be submitted to tender or some other competitive process to franchise it for pecuniary considerations. The pricing for this would be influenced by the target returns from operations.

### *Financial Analysis Results*

The first order of business is to translate the constant dollar estimates for project costs and revenues into nominal values. In carrying out this conversion, the cost of financing during construction is also determined by calculating interest on: current year costs plus previous year payments plus interest accumulated in prior years. The project costs translated into current dollars, representing the total cost of the project are shown in Table 8.3 for both the longer and a quicker construction periods.

**Table 8.3 Project Capital Cost Summary**

	<b>BASE CASE</b>	<b>HVDC</b>
	<b>\$ Millions</b>	<b>\$ Millions</b>
Total Cost - Constant \$2004	\$1,184	\$1261
Total Cost - Current \$	\$1,450	\$1550
Interest During Construction	\$257	\$263
Total to Finance	\$1,708	\$1813

The first conclusion that becomes evident is the total project costs are approximately 50% higher on account of inflation and interest expense -- \$1.7 billion versus \$1.2 billion. The advantage of a quicker construction phase is also now apparent, because a slight cost disadvantage in constant dollar terms becomes an advantage in real world conditions. The swing overall is worth \$100 million. This is the reason for preferring the Two TBM process.

The total amount to finance is \$1,708 million. Incorporating the post operation cash flows, the Internal Rate Of Return is -9.3%. This remains consistent with the conclusion of the economic analysis, that the project is not bankable on its own merits. There is no point in proceeding without access to free capital that might be made available to suit some higher purpose. Debt financing of this amount would create a situation in which losses perpetually accumulate and compound.

With a view to identifying a set of financial conditions under which the project could proceed, various scenarios involving grants or contributions were considered. The main finding is that a total contribution in the order of \$1.4 billion, or more, would be required for the project to be self sufficient.

To illustrate the impact of this point, a grant of \$1.395 billion could be dispersed over nine years to cover planning, design and most of the construction. This has been calculated at about \$60 million in total over the initial 5-year stage for planning, approval and design, and between \$250 and \$300 million per year over each of the next four years during construction. While this money is being dispersed as needed to cover current costs, interest expense is avoided. The amount to be financed as a result of this would be about \$50 million, including interest. This contribution level, was determined such that the project cash flows could provide a return around 8%. This is still below the private finance threshold considered applicable at this time, except perhaps for long-term debt, but it is close enough to illustrate the level of public support that is a prerequisite for advancing the project.

Once the appropriate level of support is decided, then the models developed for this project could be employed to explore more variations and to examine revenue and cost relationships. Without any public support, there is not sufficient justification to advance from here. The issue of public sector involvement is thus identified as a fundamental condition to resolve for advancing beyond the present pre-feasibility stage.

The larger scope issues include significant benefits that extend beyond the terms of reference, resources or time available for this project. Nevertheless, these were mentioned as important issues during consultations with outside interested parties. They include:

- Benefits to travellers and freight shippers not measured by toll revenues
- Energy price and supply impacts of HVDC e.g. industrial growth opportunities;
- Social factors attributable to a permanent fixed link between Newfoundland Island and Labrador;
- Hwy 138 in Quebec extension to the tunnel.

High prices for electrical energy in Newfoundland have been cited as a deterrent to industrial growth and a major potential benefit of a fixed link. While transportation benefits of the fixed link are anticipated by users to be significant, the primary motivation for increasing business opportunities and employment in the resource and small manufacturing sectors of the Great Northern Peninsula and Labrador is to bring power across from Labrador hydro developments and thus ensure long-term stability in the supply and price of



electrical energy. This, of course, is a positive feature that is intimately connected to justification of the tunnel.

The benefits from such new developments would not necessarily be internalized in the tunnel projections, because the fixed link across the Strait of Belle Isle is just a small part of the total transmission system that would be built to support such developments. Analyzing this potential is a major undertaking on its own. Proponents of the fixed link make a case for these advantages. Considering current trends in prices for fossil fuels and the prospect of crude oil above \$50/barrel continuing, there appears to be merit for these arguments at face value, and the beneficiaries would be the population at large.

Social factors attributable to a permanent fixed link are important considerations more closely linked to the visionary goals and objectives of the population as interpreted by the Government. They are beyond the scope of a quantitative analysis such as this project.

Finally, all of the projections contained in this study are founded on the assumption that there would be a continuous road link from Québec City to the tunnel portal along the North Shore of the Gulf of St. Lawrence. Such a project has been under consideration and preliminary estimates are reported elsewhere in this document. It is unlikely that there would be a significant growth in long-distance travel to the crossing if this route were not completed. The Trans-Labrador highway, once completed, is such a long detour that it would discourage most prospective drivers. It would thus be prudent to ensure that Highway 138 in Quebec will be built before finalizing any financial or economic justification of a transportation fixed link between the Island of Newfoundland and Labrador.

## 9 CONCLUSIONS

### 9.1 Study Findings

Of the various concepts addressed in this study to provide a fixed transportation link between Labrador and the Island of Newfoundland, a tunnel bored under the Strait of Belle Isle, at its narrowest point, is the most technically and economically attractive. A bridge or combination of causeway and bridge would be subject to very large construction and operating risks because of the challenging physical environment and would have very high capital costs. Additionally these structures could have adverse effects on the oceanography and climate of the study area. A tunnel would not be subject to the same environmental constraints.

Of the three tunnel concepts studied, a drill and blast tunnel would be more difficult to seal against water ingress and would be longer than a bored tunnel due to its greater depth; an immersed tube tunnel would be exposed to high risk from iceberg scour which would have to be accommodated through expensive ditching in bedrock or massive protection works. A tunnel created by using modern tunnel boring machines, on the other hand, with their superior water sealing capacity would allow placement at a higher level in the bedrock and consequent shorter length than in the case of a drill and blast tunnel.

The construction cost of a bored tunnel would be approximately \$1.2 billion in 2004 dollars. The total development cost for financing purposes, including escalation and interest during construction would be approximately \$1.7 billion. The construction period would be six years and an additional five years would be required for planning, additional studies and investigations and environmental assessments for an overall development period of 11 years.

Based on traffic projections over a 30 year period, the most economic tunnel arrangement would be an electric train shuttle, operating through a single tunnel with staged operation in each direction that conveys road vehicles on custom-designed rail cars. A rail tunnel results in a much smaller cross-section from that required in a road tunnel due to reduced ventilation requirements.

The economic and business case analyses were carried out for three scenarios:

- ♦ A base case for a fixed link for transportation only
- ♦ An upgraded ferry case providing increased level of service
- ♦ The base case augmented by revenue from the installation of a HVDC cable in the tunnel.

The analyses, developed by considering traffic diversion from existing services, growth in service and facility demands, the impact of both construction and operating jobs, and the inclusion of potential revenue from incorporating electrical transmission cables in the tunnel, showed that a fixed link would not attract private sector financing under normal economic and business case criteria. Using relatively optimistic diversion and growth assumptions resulted in negative rates of return and less than unity cost benefits ratios over the period of the study. This result, however, may be considered not atypical in the realm of public transportation infrastructure.

The upgraded ferry option, while not providing the same level of service, is a lower capital cost alternative but would require an annual subsidy financing approach to the crossing.

Including costs and revenue for the transmission lines has an effect on the overall viability of the fixed link. Incorporating the HVDC cables in the fixed link rather than constructing a submarine installation, reduces the capital cost to an HVDC proponent by approximately \$390 M. This cost reduction includes the cost of the cable, for which a rental would be charged by the fixed link proponent.

Of the financing methodologies addressed, some form of PPP (Public Private Partnership) arrangement would appear to be the most appropriate. An infusion of approximately \$1.4 billion from public sources would be required to make the proposition attractive to the private sector.

A review of the potential impact of industrial development in Labrador on the use of the fixed link concluded that of four industries – mining, forestry, offshore gas, and hydroelectricity - only the last was likely to have a significant potential benefit. In addition to the benefit derived from being able to incorporate high voltage transmission cables into a fixed link, one could make an argument that an overall hydroelectric development on the Lower Churchill, and possibly other rivers in southern Labrador, could lead to industrial development (such as aluminium smelting) in the area. Locating such a capacity in the vicinity of the fixed link terminus on the Labrador side would be more or less synergistic with the overall objective of government of physically linking the two parts of the province, providing electrical power to the Island from sources in Labrador, and providing an opportunity for social and economic success in northern Newfoundland and Labrador.

## 9.2 Future Required Activities

In order to progress the study to a full feasibility study and environmental assessment, the following activities would be required:

- Further geotechnical investigation along the proposed alignment. For the feasibility study, this would include the first stage of a two-stage borehole investigation within the Strait. This investigation would be costly due to the water depths involved. The expected cost would be of the order of \$10 million. The second stage of the borehole investigation would be undertaken later, in the detailed design period, and could cost up to \$20 million.
- Investigation of the ambient environmental conditions particularly along the two shorelines and within the proposed terminus areas.
- Further refinement of traffic projections. This would involve the execution of an origin/destination survey and additional tourism surveys. Considering the relative lack of sensitivity to traffic demand shown for this facility, these surveys may be deemed unnecessary. However, a full environmental assessment may require these surveys.
- Investigation of activities required for a full environmental assessment including public involvement and impact analyses.

The total cost of a full feasibility/environmental assessment study would therefore vary according to the content, certain aspects are essential and are as follows:

•	Phase 1 geotechnical investigation allowance for this activity	\$10.0 million
•	Environmental data collection	\$0.5 million
•	Study Engineering Scope	\$0.5 million
•	Full environmental assessment	\$4.0 million
	<b>Total</b>	<b>\$15.0 million</b>

Other activities are considered either optional or may be defined in a separate study as follows:

♦	Surveys for traffic projection	\$0.5 million
♦	Economic Analysis	\$0.3 million
	Total	<u>\$0.8 million</u>

The cost estimates presented in this report are to an estimate accuracy  $\pm 30\%$ . The result of undertaking the above noted feasibility/environmental assessment studies would be that the estimate accuracy would be improved to  $\pm 20\%$ .

## APPENDIX A

### STUDY PHASE 1 - LIST OF REFERENCES

**APPENDIX B**

**C-CORE ICEBERG SCOUR RISK REPORT**

## APPENDIX C

### DETAILED REPORT ON ITT OPTION

## APPENDIX D

### DETAILED BREAKDOWN OF COST ESTIMATES



**APPENDIX D (1)**

**BORED HIGHWAY TUNNEL COSTS**

**APPENDIX D (2)**

**DRILL & BLAST HIGHWAY TUNNEL COSTS**

**APPENDIX D (3)****IMMERSED TUBE HIGHWAY TUNNEL COSTS**

**APPENDIX D (4)**  
**HIGHWAY BRIDGE COSTS**

**APPENDIX D (5)**

**HIGHWAY CAUSEWAY COSTS**

**APPENDIX D (6)**

**BORED RAIL TUNNEL COSTS (1 TBM)**

**APPENDIX D (7)**

**BORED RAIL TUNNEL COSTS (2TBM'S)**

**APPENDIX D (8)**

**DRILL & BLAST RAIL TUNNEL COSTS**



**APPENDIX D (9)**

**IMMERSED TUBE RAIL TUNNEL COSTS**

**APPENDIX D (10)**

**HIGHWAY CONNECTION COSTS**

**APPENDIX E**

**BREAKDOWN OF ROAD TUNNEL  
OPERATING AND MAINTENANCE COSTS**

**APPENDIX F**

**BREAKDOWN OF RAIL TUNNEL  
OPERATING AND MAINTENANCE COSTS**

**APPENDIX G**

**ECONOMIC ANALYSIS WORKBOOKS**