

Review of Low Energy Cooling Technologies

IEA Annex 28 – Subtask 1

© British Crown Copyright 1995

All property rights, including copyright are vested in the Operating Agent (Building Research Establishment) on behalf of the International Energy Agency.

In particular, no part of this publication may be reproduced, stored in a retrieval system or transmitted in any form or means, electronic, mechanical, photocopying, recording or otherwise, without the prior written permission of the Operating Agent.

ACKNOWLEDGMENTS

Thanks are due to the following organisations for their assistance in the management of IEA Annex 28:

The United Kingdom's Building Research Establishment (BRE) and Construction Sponsorship Directorate of the Department of the Environment for their funding, under the Energy Related Environmental Issues programme (EnREI), of Oscar Faber Applied Research as the Annex 28 Operating Agent.

Thanks are also due to the Buildings Group of CANMET - Energy Technology Branch, the research arm of Natural Resources Canada, which has provided funding for sub-task one of IEA Annex 28 and for the editing of this report by Fraser & Associates.



CANMET

Canada Centre for
Mineral and Energy
Technology

Centre canadien de la
technologie des
minéraux et de l'énergie

SUMMARY

This report comprises a number of contributions from individual member countries participating in Annex 28. Each chapter is a summary of the current state of the technology in that particular country and should not be taken as representative of the situation on a worldwide basis. Many of the technologies considered in this report are in their early stages of entry into a particular market place, the aim of this Annex being to assess the suitability of such technologies on a wider basis and to provide the supporting design advice and modelling techniques necessary to assess this. It is not possible therefore to provide definitive guidance at this early stage of the Annex work

The cooling technologies described in this report cover a full range of applications: residential and commercial buildings, for new and retrofit applications, and for a variety of climates. The following chart provides a quick overview of the main type of applications suitable for each technology. Although it is theoretically possible to apply these technologies to any type of building, for practical purposes they are primarily suited to the following types of buildings.

	Includes main source of cooling	Building type				Climate restriction
		Res.	Comm.	New	Retrofit	
Cooling by night ventilation	√	√	√	√	√	Some
Ground cooling (air)	√	√	√	√		Some
Slab cooling (air)	√		√	√		Some
Desiccant dehumidification	√	√	√	√	√	Some
Evaporative cooling	√	√	√	√	√	Some
Slab cooling (water)		√	√	√		Some
Chilled ceilings with displacement ventilation			√	√		
Ground cooling (water using aquifers)	√		√	√	√	Some

All of the technologies reduce the need for refrigerants. In fact, none of the technologies that include the main source of cooling use a refrigerant. Most of the technologies have some limitation in peak cooling or total cooling capacity, but by combining them with each other or in conjunction with an active cooling system the overall cooling performance can be increased.

These technologies provide cooling in an energy efficient manner, thus reducing energy consumption and peak demands for electricity. They do so by making use of low quality (i.e. warmer) sources of cooling; whether it be ambient air or ground temperatures or warmer chilled water. From a philosophical point of view, one could say that in designing these systems we trade brain power for cooling power. Passive and hybrid cooling systems force designers to take a systematic or holistic approach to designing buildings.

There is a great deal of untapped potential in passive and hybrid cooling technologies. It is the goal of this IEA Annex to make people more aware of these technologies and to develop design tools which will assist them in being adopted.

Table of Contents

ACKNOWLEDGMENTS II
SUMMARY III
ABBREVIATIONS AND ACRONYMS VIII
PREFACE IX
INTRODUCTION 1
1. NIGHT VENTILATION 3
1.1 RESIDENTIAL BUILDINGS 4
1.1.1 Applications 4
1.1.2 Energy performance 4
1.1.3 Costs 5
1.1.4 Status 5
1.2 COMMERCIAL BUILDINGS 7
1.2.1 Applications 7
1.2.2 Energy performance 8
1.2.3 Costs 9
1.2.4 Status 10
2. GROUND COOLING WITH AIR 12
2.1 APPLICATIONS 13
2.2 ENERGY PERFORMANCE 14
2.3 COSTS 15
2.4 STATUS 16
3. SLAB COOLING WITH AIR 17
3.1 APPLICATION 18
3.2 ENERGY PERFORMANCE 19
3.3 COSTS 19
3.4 STATUS 20
4. DESICCANT COOLING 21
4.1 APPLICATION 22
4.2 ENERGY PERFORMANCE 23
4.3 COSTS 23
4.4 STATUS 24

5. EVAPORATIVE COOLING.....	25
5.1 APPLICATIONS	27
5.2 ENERGY PERFORMANCE AND WATER USAGE	28
5.3 COSTS	29
5.4 STATUS.....	30
6. SLAB COOLING WITH WATER	32
6.1 APPLICATION.....	33
6.2 ENERGY PERFORMANCE	34
6.3 COSTS.....	34
6.4 STATUS.....	35
7. CHILLED CEILINGS AND DISPLACEMENT VENTILATION	36
7.1 APPLICATIONS	37
7.2 ENERGY PERFORMANCE	38
7.3 COSTS	39
7.4 STATUS.....	40
8. GROUND COOLING WITH WATER USING AQUIFERS	41
8.1 APPLICATIONS	43
8.2 ENERGY PERFORMANCE	43
8.3 COSTS	44
8.4 STATUS.....	48

APPENDIX A – CLIMATES	49
A1. DESIGN TEMPERATURES	52
A2. MEAN DAILY TEMPERATURE RANGE AND AVERAGE YEARLY AIR TEMPERATURE	53
A3. COOLING DEGREE HOURS AND ENTHALPY HOURS	54
A4. SOLAR RADIATION	56
APPENDIX B – BUILDING STANDARDS AND PRACTICES	63
B1. THERMAL COMFORT	63
B1.1 ASHRAE Standard 55-92	64
B2. VENTILATION	66
B3. BUILDING ENVELOPE CHARACTERISTICS	69
B3.1 Window glazings	69
B3.2 Building envelope U-values	71
B3.3 Air leakage rates	71
B4. INTERNAL HEAT GAINS	74
APPENDIX C – ENERGY SOURCES AND COSTS	76
C1. ENERGY SOURCES	76
C2. ENERGY COSTS	77
APPENDIX D - WATER COSTS	81
D1. COSTS (ECU)	81
D2. COSTS (US\$)	82
APPENDIX E – EXCHANGE RATES	83
APPENDIX F – TECHNOLOGY AND NATIONAL DATA AUTHORS	84
APPENDIX G - ADDITIONAL REFERENCES	87

ABBREVIATIONS AND ACRONYMS

ACH	–	air changes per hour
cfm	–	cubic feet per minute
clo	–	clothing insulation value (1 clo = 0.155 m ² · K / W)
COP	–	coefficient of performance, the amount of cooling energy provided divided by the amount of energy that went into the system
d. p.	–	dew point temperature
GJ	–	gigajoule
HVAC	–	heating, ventilation and air conditioning
IAQ	–	indoor air quality
kW	–	kilowatt
kWh	–	kilowatthour
L	–	litre(s)
L/s	–	litres per second
N.A.	–	data not available or not applicable
MJ	–	megajoule
ODP	–	ozone depletion potential
RH	–	relative humidity
VAV	–	variable air volume

PREFACE

The International Energy Agency (IEA) was established in 1974 within the framework of the Organisation for Economic Co-operation and Development (OECD) to implement an International Energy Programme. A basic aim of the IEA is to foster co-operation among the twenty-one IEA Participating Countries to increase energy security through energy conservation, the development of alternative energy sources and energy research, development and demonstration (RD&D). This is achieved in part through a programme of collaborative RD&D consisting of forty-two Implementing Agreements, containing a total of over eighty separate energy RD&D projects. This publication forms one element of this programme.

Energy Conservation in Buildings and Community Systems

The IEA sponsors research and development in a number of areas related to energy. In one of these areas, energy conservation in buildings, the IEA is sponsoring various exercises to predict more accurately the energy use of buildings, including comparison of existing computer programs, building monitoring, comparison of calculation methods, as well as air quality and studies of occupancy. Seventeen countries have elected to participate in this area and have designated contracting parties to the Implementing Agreement covering collaborative research in this area. The designation by governments of a number of private organisations, as well as universities and government laboratories as contracting parties, has provided a broader range of expertise to tackle the projects in the different technology areas than would have been the case if participation was restricted to governments. The importance of associating industry with government sponsored energy research and development is recognised in the IEA, and every effort is made to encourage this trend.

The Executive Committee

Overall control of the programme is maintained by the Executive Committee (ExCo) and the Implementation Agreement on Energy Conservation in Buildings and Community Systems (B&CS), which not only monitors existing projects but also identifies new areas where collaborative effort may be beneficial. The Executive Committee ensures that all projects fit into a pre-determined strategy, without unnecessary overlap or duplication but with effective liaison and communication. The Executive Committee has initiated the following projects to date (completed projects are identified by *):

- | | |
|-----|---|
| I | Load Energy Determination of Buildings* |
| II | Ekistics and Advanced Community Energy Systems* |
| III | Energy Conservation in Residential Buildings* |
| IV | Glasgow Commercial Building Monitoring* |
| V | Air Infiltration and Ventilation Centre |
| VI | Energy Systems and Design of Communities* |
| VII | Local Government Energy Planning* |

VIII	Inhabitant Behaviour with Regard to Ventilation*
IX	Minimum Ventilation Rates*
X	Building HVAC Systems Simulation*
XI	Energy Auditing*
XII	Windows and Fenestration*
XIII	Energy Management in Hospitals*
XIV	Condensation*
XV	Energy Efficiency in Schools*
XVI	BEMS - 1: User Guidance*
XVII	BEMS - 2: Evaluation and Emulation Techniques*
XVIII	Demand Controlled Ventilating Systems*
XIX	Low Slope Roof Systems*
XX	Air Flow Patterns within Buildings*
XXI	Thermal Modelling
XXII	Energy Efficient Communities*
XXIII	Multizone Air Flow Modelling (COMIS)
XXIV	Heat Air and Moisture Transfer in Envelopes
XXV	Real Time HVAC Simulation
XXVI	Energy Efficient Ventilation of Large Enclosures
XXVII	Evaluation and Demonstration of Domestic Ventilation Systems
XXVIII	Low Energy Cooling Systems
XXIX	Daylighting in Buildings
XXX	Bringing Simulation Models to Engineers

A. Introduction

Cooling is a significant user of energy in buildings, and its importance as a contributor to greenhouse emissions is enhanced by the fact that these systems are usually electrically driven. High cooling requirements can result in high electrical demands, with consequent problems for utility companies. Increasing use of information technology has led to an increasing demand for cooling in the commercial buildings sector.

In response to these issues, The IEA's Future Building Forum workshop on Innovative Cooling (held in the United Kingdom in 1992) identified a number of technologies with the potential to reduce energy consumption in the field of alternative cooling strategies and systems, leading to the establishment of Annex 28. The emphasis for this project is on passive and hybrid cooling technologies. Such cooling technologies or strategies require close integration of the dynamics of the building structure with the HVAC systems, and this is precisely the area in which the B&CS ExCo has established expertise.

B. Objectives

Passive and hybrid cooling systems will only be taken up in practice if such systems can be shown to meet certain criteria.

- a) the life cycle costs (including energy, maintenance etc.) of such systems are less than 'conventional' systems;
- b) the level of thermal comfort provided is acceptable to the occupants in the context of their task;
- c) the systems are sufficiently robust to changes in building occupancy and use;
- d) the design concepts for such systems are well defined, and that appropriate levels of guidance are available at all stages of the design process, from sketch plan to detailed;
- e) the necessary design tools are available in a form which designers can use in practice; and
- f) the cooling system is shown to integrate with the other systems (e.g. heating and ventilation), as well as with the building and the control strategy.

The objectives of the annex are to work towards fulfilling these requirements.

C. Means

The project is sub-divided into three main activities which relate to the three phases of researching and documenting the various cooling strategies. The objective is to deliver source books and design tools very much targeted at the building designer and operator, to ensure the maximum uptake of the technology in both new buildings and the retrofit of existing buildings. This report is the product of the first phase of the work — Subtask 1: Description of Cooling Strategies.

The other elements of the programme of work are summarised below. Reports on these phases will follow in due course.

Subtask 2 — Development of Design Tools

It is vitally important that these design aids be addressed at two different levels.

a) Early design

By definition, hybrid cooling is as much about architecture as it is about engineering, and the design philosophy is usually set by the architect. It is during the very early stages of design that most of the key decisions are taken. These decisions will dictate whether a low energy cooling concept is possible or not. The information to support the development of low energy cooling strategies must be available in a form to influence this stage of design. Detailed simulation tools are not the answer, since the detailed data input is not available, and the architect is not usually willing/able to use such sophisticated tools. The emphasis must be on simple tools, 'rules of thumb', design charts etc... The detailed design tools will be an important input into the development of these early design tools.

b) Detailed design

At this stage, the broad principles of the design have been finalised, and the purpose is to optimise the design within a well defined set of constraints. A lot of work has been done on developing design and evaluation models in the context of 'traditional' buildings, but less information is available on algorithms and data to support the types of cooling concepts to be addressed by this project. For example,

- i) for a natural ventilation strategy, many programs exist to predict air flows for a given leakage distribution and wind regime – what does not exist is a program which takes the required air exchange rates as data, and predicts the required position and size of ventilation openings needed; and
- ii) the commonly used comprehensive building simulation programs do not have algorithms for modelling 'specialist' processes like desiccant cooling.

It is recognised that it will be impractical to develop a single model which will be agreed internationally. However, it should be possible to develop and agree to the specialist algorithms which need to be developed, and to document them in such a way as to make them easily used by the various codes which may want to incorporate them.

It is therefore proposed that work be undertaken to develop and prove the necessary algorithms and methods to enable these cooling processes to be modelled within the context of whole building performance. Some simple building descriptors will be developed, along with 2-3 standard weather sets representing different climate regions of the participating countries. It is not the intention to carry out inter program comparison exercises, but rather to provide a reference benchmark set against which new models can be checked in broad terms. It is also anticipated that participants will carry out detailed analysis of key parameters to give a clear picture of the factors which control the successful application of low energy cooling systems. This will lead into the development of simplified design tools (see point a) above.

Some of the participants will be carrying out measurement work in test cells and climate chambers. This information will complement the parametric analysis being undertaken using the detailed models, and will provide input to the simple models.

Subtask 3 — Demonstration Projects

The third element of the proposed program of work is to illustrate the various cooling technologies through demonstrated case studies, preferably involving real buildings rather than just theoretical exercises. This is seen as a very important aspect of the overall program, since it should provide the necessary confidence to the construction industry that hybrid cooling technologies can provide acceptable working environments and life cycle cost advantages compared with mechanically cooled buildings.

Each country will identify and document a building which reflects its own interest in a particular cooling technology and strategy, and is consistent with its own national priority. These case studies should build upon the other subtask reports and describe how the design was developed and optimised. Particular attention should also be given to documenting the practical construction and maintenance issues associated with the installation. Wherever possible, field measurements of performance should be included, relating to:

- a) energy performance (kW-hr/m²/annum) and
- b) thermal comfort (temperatures, diurnal ranges etc.).

It is not anticipated that detailed monitoring will have taken place, although such information will be very welcome if available. However, sufficient measured data, combined with occupant responses, should be available to allow a reasonable assessment of how well the cooling strategy has fulfilled the design intent.

Another element of this sub-task is to test the robustness of the design to changes in climate, building use etc. Clearly these cannot be done with the real building, but use will be made of the tools developed in task 2b to quantify the success of the design concept in responding to different scenarios.

If time and resources permit, participants will be encouraged to provide (by using simulation exercises), detailed evaluations of how alternative strategies might have fulfilled the requirements of the design brief for that building.

The end result of this element of the work will be firm evidence of the type of buildings that can be achieved using passive and hybrid cooling technologies. These can act as demonstrators of the benefits accruing from IEA collaborative activity, and provide firm

evidence to the building sector of the real benefits of promoting an integrated design philosophy.

D. Participation

The participating countries in this task are Canada, Germany, Finland, France, Netherlands, Portugal, Sweden, Switzerland, United Kingdom and the United States of America. The funding groups for each country are given below.

Canada	Buildings Group CANMET- Energy Technology Branch, NRCan 580 Booth St. Ottawa, Ontario K1A 0E4
	Heat Management Technologies Energy Diversification Research Laboratory CANMET - Energy Technology Branch, NRCan 1615, Montée Ste-Julie C.P. 4800 Varenes, Québec J3X 1S6
Germany	Bundesministerium für Bildung Technologie und Forschung (BMBE) Postfach 200240 Bonn, Germany
Finland	Technology Development Centre P.O. BOX 69 Fin - 00101 Helsinki
France	Agence de l'environnement et de la maîtrise de l'énergie Fédération nationale du bâtiment Ministère de l'équipement - Plan Construction Architecture Centre scientifique des techniques du bâtiment Ecole des mines de Paris Gaz de France
Netherlands	Novem BV Swentiboldstraat 21 P.O. BOX 17 6130 AA Sittard

Portugal	Center for Energy Conservation Praceta à Estrada de Alfragide Alfragide 2700 Amadora
	Department of Mechanical Engineering University of Porto R. Bragas 4099 PORTO Codex
Sweden	Swedish Council of Building Research P.O. BOX 12866 S - 11298
Switzerland	Swiss Federal Office of Energy Berne 3003
United Kingdom	British Gas EA Technology Gardiner & Theobald Haden Young/Balfour Beatty Building MEPC Investments Oscar Faber Ove Arup Department of the Environment Building Research Establishment
United States of America	Office of Building Technologies U.S. Department of Energy 1001 Independence Avenue Washington DC 20585

INTRODUCTION

This report reviews the current status of various low energy cooling technologies which are being examined in IEA Annex 28. The technologies examined in this annex may be considered **passive** and **hybrid** cooling systems. The term *passive cooling*, used in this context, should not be confused with *passive cooling building design* which focuses on reducing the cooling loads by reducing the internal heat gains (through the use of more efficient lighting and office equipment), or by reducing solar gains (with advanced glazing systems or optimizing the size and placement of windows and overhangs), or reducing other means of heat transfer into the building (such as with the use of vegetation for external shading, more insulation or the reduction of air infiltration). Annex 28 assumes that the cooling loads have already been reduced as much as possible and focuses on meeting the remaining load in an energy efficient manner.

The technologies addressed in this report can be divided into two groups: ones that include the main source of cooling and ones that focus solely on the delivery of the cooling to the treated space. The first group can be considered **passive** cooling systems in that they rely on natural sources for the cooling, such as the ambient air or the ground. In addition, some of the technologies use the heat transfer that occurs with water evaporation or condensation in the air as the source for sensible or latent cooling (e.g. Evaporative Cooling and Desiccant Cooling). Fans and/or pumps are required in all of these systems (except for night cooling with natural ventilation) to deliver the cooling, but they are not like the traditional mechanical refrigeration systems which rely on a vapor compression cycle for the cooling source, which are usually dependent on HCFCs or HFCs, and which tend to cause high peak electrical demands.

The second group of technologies focus on delivering the cooling to the treated space in an efficient manner. Slab Cooling with Water and Chilled Ceilings with Displacement Ventilation can be used to make a conventional cooling system work more efficiently or may be combined with a passive cooling system. These technologies work well with lower grade sources of cooling, since they separate the ventilation load from the cooling load.

For that matter, most of these passive cooling technologies may be combined with each other or with more conventional forms of cooling and this is one of the reasons they may be considered to be **hybrid** technologies. In addition, many of the technologies rely on close integration with the building structure. Many of them make use of a building's thermal mass for the purposes of storage and some must, or should be, incorporated within the building's walls, floors or foundation.

One might consider these cooling *technologies* to be cooling *strategies*. Most of the individual components of the systems are already common HVAC components, such as fans, motors, heat exchangers, but it is the manner in which they are applied that makes these systems innovative cooling methods. This report will highlight some of the principles of the control strategies necessary for these cooling systems to operate effectively.

Although all of these technologies are sufficiently developed to have been applied in real buildings, it must be realized that, relative to more conventional means of cooling, these technologies are still at the beginning of their development. Although some of these technologies have already gained wide acceptance in a certain building sector or climate, this information is not common knowledge to the typical HVAC engineer or architect.

This report does not intend to provide detailed design information, but to entice all those involved in the design of buildings to consider alternative methods for providing cooling. Subsequent phases of the Annex 28 will develop useful design tools and more detailed information on the installation and implementation of the technologies. (For more detailed information on any of the technologies, you may wish to contact the author of the appropriate chapter, listed in Appendix F.) This report is intended for building developers, architects, engineers, manufacturers, utilities or governments. All those involved in building development should be aware of the variety of means that exist to provide cooling in a building, whether it be a small residential building or a large commercial or industrial facility, a retrofit application or new construction.

Energy performance values and current costs for installing and maintaining these cooling technologies are also included in this report. Although costs were initially given in the currency for the country preparing the report, these have been converted to ECU and U.S. \$, using the exchange rates given in Appendix E, to make the information more universal. Costs will vary somewhat from country to country due to variations in labor and material costs. As well, costs are typically decreasing for these relatively new technologies as they become more developed and more commonly applied.

Some of the technologies described in this report may not be suited to all types of cooling loads, building types or climates. To assist readers in determining what cooling technology may be appropriate for their buildings, detailed information has been provided in the appendices on the climates (Appendix A), the building characteristics (Appendix B), the energy sources and costs (Appendix C) and the water costs (Appendix D) for the countries participating in this annex. With this information readers can determine which participating countries have characteristics similar to their own and hence which cooling technologies may be appropriate for them. (Refer to the Preface, section D, for a list of the participating countries.)

Appendices A to C are based on "National Data" reports prepared by each participating country. If you wish to obtain a copy of the complete National Data report for a particular country, please contact the appropriate author listed in Appendix F.

Appendix G provides additional references pertaining to the various technologies.

Readers are reminded as to the early stage of the various technologies and therefore, as previously outlined in the Summary section, they are not necessarily representative of such technologies on a world-wide basis.

1. NIGHT VENTILATION

Night ventilation, or night-time cooling, is used to lower the temperature in the building when the outdoor temperature is lower than the indoor temperature, which typically occurs at night. It improves the comfort directly during the night, but also cools the building structure, thus reducing the peak temperature during the following day. The efficiency of the system depends on the air flow rate, the temperature difference between the outdoor and indoor air, and the effective thermal mass of the building interior. An integrated design approach is essential for the success of this technology.

Mechanical or natural ventilation may be used for night cooling, or a combination of the two. With natural ventilation there is no direct control of the ventilation rate. With mechanical ventilation, either the normal ventilation system can be used with a modified control strategy and possibly an increased air flow rate, or an additional ventilation system may be used. It is important to ensure at higher flow rates that the ventilation system is not too noisy if it will cause a nuisance in occupied areas, although this is unlikely. In a number of commercial applications a lower rather than a higher rate of ventilation is used at night to minimise fan heat pick-up and fan energy consumption.

The thermal mass of the structure plays a major role in the efficiency of the night-time ventilation system by reducing temperature swings. Thermal mass may reduce the temperature swings between night and day, or reduce the indoor daily mean temperature during warmer days by having decreased the thermal mass temperature during previous colder ones. (In most cases warmer days sequences do not last more than about five days). Therefore, it is important to make the distinction between the daily inertia (24 hour cycle) and sequential inertia (2 week cycle). To be efficient, a thermal mass must be directly linked with the indoor temperature. Therefore, additional thermal resistances, such as carpet or insulation, reduce the effectiveness of thermal mass in the structure.

Night cooling can be applied to either commercial or residential buildings. The design and operating methods for each of these building types are different due to variations in occupancy patterns, internal heat gains and internal furnishings. For example, the fact that offices are unoccupied at night allows the use of very high night-time ventilation rates. On the other hand, houses are occupied at night and thermal comfort during the night as well as during the day must be considered. In addition, commercial buildings typically have small latent cooling loads relative to sensible loads; whereas in residential buildings, domestic activities like cooking, showering and laundry increase the relative importance of latent cooling.

For this reason, this report reviews night cooling for residential buildings separately from commercial buildings. At first glance some of the information for residential buildings may appear to contradict the information for commercial buildings, but as explained above, these different building types require different methodologies. In this report, the residential section focuses primarily on natural ventilation. The commercial building section involves some natural ventilation, but focuses more on mechanical ventilation, which may be used alone or in conjunction with an air conditioning system.

1.1 Residential Buildings

by: Jean Robert Millet, Centre Scientifique et Technique du Bâtiment, France

(This section is based on detailed energy simulations using TRNSYS and on site measurements in about 20 houses and dwellings in different climates.)

With natural ventilation systems in residential buildings, the air flow is mainly due to windows being opened. Typical air change rates of between 5 and 20 ACH may be achieved in residential buildings with natural ventilation, but issues such as privacy, protection against robbery and outdoor noise must be addressed. It is important with natural ventilation cooling in residential buildings that the designs allow for cross ventilation, with windows on each side of the building. To enable good control of the air flow rate during the night, windows should also have some means of being kept open in various positions (e.g. half opened or completely opened). Additionally, in some cases, shutters should be designed in order to allow air flow but remain a protection against robbery or natural lighting (e.g. for bedrooms).

Whether the system is controlled automatically or manually, the goal is to precool the building as much as possible during the night-time in order to prevent overheating during the following day. During warm weather, night ventilation can always be used, but when the days are cooler there can be a conflict between comfort during the night and comfort during the day. This is often the case when indoor temperature swings are high, which occurs for lightweight buildings or ones with large solar gains. As well, the air speed must be limited so as not to cause thermal discomfort, especially at night when the outdoor temperature is less than about 15°C. If an air-conditioning system is used in the building, its controls have to be linked to the night-time ventilation system.

With mechanical ventilation night cooling in residential buildings, air flow rates greater than those required for indoor air quality are required. Care must be taken to limit the noise of the system in residential buildings where people are trying to sleep at night.

1.1.1 Applications

This technology is suitable for all residential buildings; although in cities, natural ventilation may be hard to use because of outdoor noise and the difficulty in having cross ventilation. The technology works best in buildings with a high thermal mass and with low solar heat gains. No additional space is required for natural ventilation, although larger ducts and fans may be required for mechanical systems. The technology is suited for moderate to moderately hot climates, with night-time temperatures during the warm season less than about 22°C. Large diurnal temperature swings improve the system efficiency.

1.1.2 Energy performance

No additional energy is required for natural ventilation systems. With mechanical ventilation, the energy consumption depends greatly on the system design (i.e. the pressure loss in ducts and the flow rates).

For natural ventilation, the efficiency of the system will be highly dependant on inhabitant behavior and the potential for opening windows. From computer simulations, it was determined that, depending on the thermal inertia and solar gains, a decrease in the peak temperature of 3°C to 7°C can be obtained. The decrease in the peak is greater for higher solar gains, but the absolute temperature is also higher.

This technology provides only sensible cooling and if the climate is very humid, may increase the latent cooling loads during the day. In humid climates when air conditioning is also used, care must be taken not to increase the latent cooling loads too much during the day by bringing in too much moisture during the night.

1.1.3 Costs

For natural ventilation, costs may be incurred to improve the building structure (e.g. special shutters or windows, outer insulation for increasing the effective thermal mass). If a mechanical ventilation system is used, additional costs may be required to increase the mechanical ventilation and to control the ventilation.

1.1.4 Status

For natural ventilation, the basic equipment is available although some new products (e.g. sound proof shutters which have a high air permeability) could be developed in order to widen the field of application. For mechanical ventilation, the basic components are available, but there are no off-the-shelf designs. Specific problems such as the reduction of noise still have to be addressed.

The main barrier with this technology being accepted relies on inhabitant behavior and acceptance. Do the inhabitants realize that they have to open the windows at night to increase their thermal comfort during the day? Are the inhabitants willing to make the effort to open windows at night as required? How do the occupants feel with windows opened at night, taking into account issues such as outdoor noise, security, privacy and light?

Simplified predesign tools or guides have to be provided to the designer, as the main factors which affect the system performance (such as window orientation, window shading coefficients and thermal mass) have to be taken into account at the first stage of design. A simplified tool called "COMETres" (Comfort evaluation tool for residential buildings) is available for predicting thermal comfort. The program calculates the indoor temperature profile that would result for a particular day. COMETres runs on an Excel spreadsheet and is applicable for a full range of applications. The inputs are simple thermal and architectural characteristics (U value, solar factor, areas, orientation). COMETres has incorporated a natural ventilation model; the ventilation due to window openings is calculated from the windows' characteristics. COMETres has been tested against TRNSYS and maximum and minimum temperatures were in agreement.

"Qualitel profile point P" is another tool that is available to designers. It consists of design charts which have been derived for the most typical cases (e.g. standard buildings and window solar protection).

The following are the charts' inputs:

- climate zone
- thermal mass
- possibility of cross ventilation
- noise exposure of windows

The outputs are:

- amount of solar protection required on the windows
- indication of whether or not a cooling system is required.

TRNSYS can also be used for detailed simulation.

1.2 Commercial Buildings

by: Maria Kolokotroni, Building Research Establishment, United Kingdom

(This section is based on a literature review, computer simulations using APACHE and short term monitoring of buildings.)

Ideally, night-time ventilation is driven by natural forces, such as wind pressures due to night breezes and thermal buoyancy (stack effect). In commercial buildings, the natural ventilation may be increased through the use of wind towers, passive stack ventilation, ventilation through atria and solar chimneys. When the flow rates are insufficient or natural ventilation is inappropriate, mechanical ventilation can be used so that the night ventilation either provides all of the necessary cooling or it reduces the use of active cooling during the day. In any case, controls are needed to monitor the outside and indoor conditions to prevent overcooling and discomfort in the early morning.

As with many passive and hybrid cooling systems, thermal mass plays an important role in the implementation of night-time ventilation for cooling. To ensure maximum cooling of the mass, the night-time ventilation air flow paths may be different from the daytime paths. Night-time ventilation is sometimes directed through voids within the structure, such as hollow floors. A separate ducting system might be necessary for some applications. From experiments and mathematical modelling, it has been found that any thickness of dense concrete greater than about 50 mm has very little effect on the diurnal temperature cycles, although these larger thicknesses may become significant in weekly or seasonal variations.

1.2.1 Applications

Night-time ventilation systems are an integral part of the building. Spatial layout, partitioning and thermal mass have to work together to facilitate the cooling potential of night air. The mass should not be isolated by lightweight finishes, such as dry lining or suspended ceilings, or it will have less of an effect on the thermal behaviour of the building. This may be a problem in modern offices, which use carpets and suspended ceilings. The problem can be overcome by using thermally-heavy dry lining or a false floor void. In the latter case, the mass underneath the false floor is cooled by using the false floor void for the supply air.

The technology is particularly suitable for non-residential buildings that remain unoccupied at night and where high air flows can be used. The most appropriate application is in buildings which are unoccupied during the night and which have regular cycles of heat gains. Office buildings are a perfect example. New design and in some cases refurbished buildings are suitable for the technology.

No additional space is required for simple natural ventilation systems. Some natural ventilation systems (i.e. passive stacks and wind towers) require dedicated 'space'. If systems such as solar chimneys are used, they must be thermally decoupled from the rest of the building because of the high temperatures which will make adjacent spaces uninhabitable. Mechanical ventilation systems may require some additional space if more ventilation is provided than required for the standard HVAC system.

Night cooling is appropriate in any location with suitable weather conditions. The technology is best suited to hot or moderate climates with large diurnal temperatures over the summer. In mechanical ventilation systems, night-time temperatures must be cool enough to make up for the 1°C to 2°C heat gain due to the fans. As well, the humidity ratio of the air should be less than 15g/kg dry air since the technology provides primarily sensible cooling.

1.2.2 Energy performance

The technology is capable of satisfying moderate cooling loads. Simulation runs have indicated that depending on external conditions and the building details (i.e. thermal mass and external heat gains), night cooling is capable of providing cooling for up to 40 W/m² of internal heat gains. In humid climates, care must be taken not to bring in too much moisture at night which would cause discomfort during the following day.

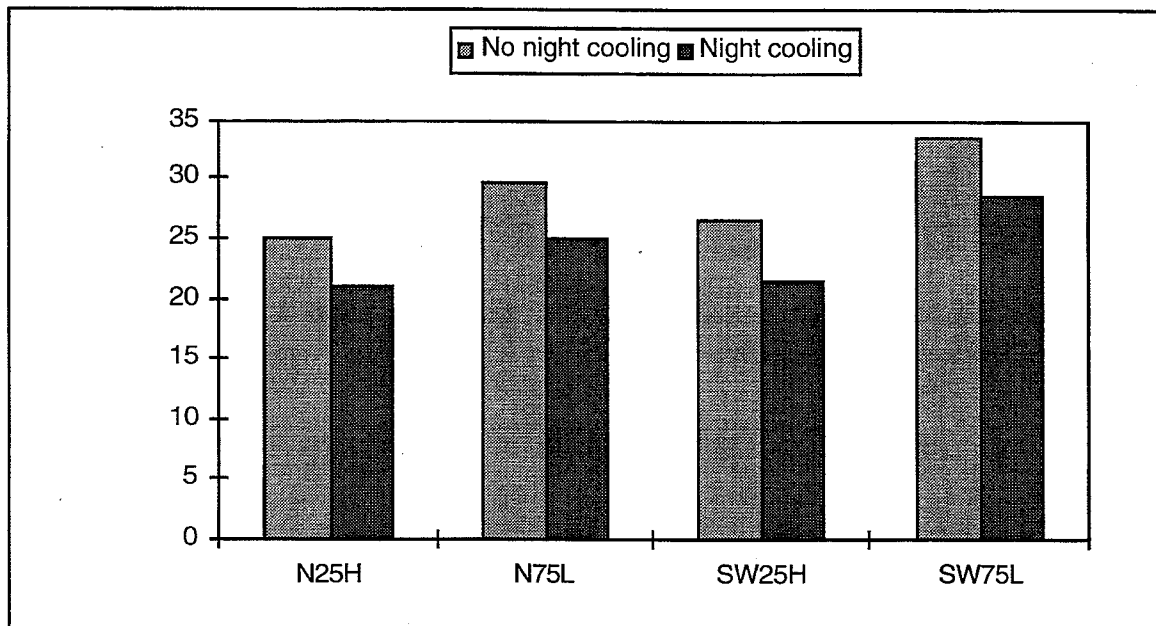

Figure 1-1: Peak temperatures in buildings with and without night cooling

Computer simulations indicate that night-time ventilation can lower the daytime temperatures in heavyweight buildings by about 3°C. (Refer to Figure 1-1.) The previous figure shows the reduction in peak temperature for different building orientations (N = North; SW = Southwest), for different amounts of glazing (25% and 75%) and for different thermal masses and internal heat gains (H = heavy weight building with low internal heat gains of 10 W/m²; L = light weight building with high internal heat gains of 40 W/m²).

When mechanical ventilation is used, electricity is required to drive the fans. The amount of energy required depends greatly on the design of the fan system. For example, energy consumption could be between 1 to 9 kWh for fans to deliver 5 ACH to a 180 m³ room over a 24 hour period. The energy consumption depends on the system

resistance. For a local fan the system resistance may be in the order of 50 to 200 Pa; whereas, for a centralised system the resistance may be as high as 2000 Pa.

With night-time ventilation the energy storage performance depends on effective thermal contact between the thermal mass and the cool night air. This may require the use of fans to direct the air over the surface of slabs. Raised floors, which are commonly used to provide thermal contact between the building structure and the air supplied by the mechanical ventilation systems are unlikely to be suitable for natural night time ventilation. Such systems will require the use of exposed coffered or troughed slabs for the ceiling.

A key advantage of night cooling in commercial buildings is that it shifts the load demand from the day to night, offering the potential for demand savings and the use of lower night-time electricity rates. Night cooling may, for example, reduce the fan energy consumption during the day due to a reduced cooling load requirement. The following tables shows the annual cooling energy costs for a building in the United Kingdom with a conventional (vapour compression chiller) air conditioning system versus a night-time cooling system with mechanical ventilation. These values assume an overall COP of 2 for the air conditioning system and a 100 Pa pressure drop in the ventilation system for the night-time cooling system.

Table 1-1a: Annual energy costs for cooling (ECU)

Cooling system	ECU/m ² /year
Conventional air conditioning	0.54
Night-time cooling with mechanical ventilation	0.04

Table 1-1b: Annual energy costs for cooling (US\$)

Cooling system	US\$/m ² /year
Conventional air conditioning	0.61
Night-time cooling with mechanical ventilation	0.04

In addition to energy savings, the technology may improve the indoor air quality due to the night-time flushing of the building; however, the possibility of pollution in the outdoor air being used to flush the building should be considered.

1.2.3 Costs

Cost data for mechanical and natural ventilation systems have recently been published by the Building Services Research and Information Association ("Dynamic Energy Storage in the Building Fabric", N. Barnard, BSRIA Technical Report TR9/94). The following tables summarise the capital and maintenance costs for night cooling systems and a conventional (vapour compression chiller) air conditioning system. The costs for finishing an exposed slab, whether it be coffered or troughed, are estimated to be similar to those for a false ceiling. A raised floor, however, may cost significantly more than good quality carpet tiles.

**Table 1-2a: Capital and maintenance costs (ECU)
(Commercial Application)**

Cooling system	Floor and ceiling type	Installation and Equipment costs (ECU/m ²)	Maintenance costs (ECU/m ² /yr)
Night-time cooling with mechanical ventilation (extract system only)	Exposed slab	106	Data N.A.
Night-time cooling with natural ventilation	Exposed slab	86	5.55
Conventional air conditioning	Any	264	13.96

**Table 1-2b: Capital and maintenance costs (US\$)
(Commercial Application)**

Cooling system	Floor and ceiling type	Installation and Equipment costs (ECU/m ²)	Maintenance costs (ECU/m ² /yr)
Night-time cooling with mechanical ventilation (extract system only)	Exposed slab	119	Data N.A.
Night-time cooling with natural ventilation	Exposed slab	97	6.26
Conventional air conditioning	Any	298	15.73

In regards to the maintenance costs, the large cost differential between air conditioning and natural ventilation indicated in Tables 1-2a and 1-2b, which relates to overall building stock, is mainly due to greater use of air conditioning in prestige developments.

1.2.4 Status

The basic equipment necessary for night-time cooling with mechanical ventilation (i.e. fans and ducting) is already in existence; however, their integration into the building still needs to be developed and subsequent phases of the Annex will focus on this aspect. For natural ventilation to be an acceptable cooling technique for designers, practical solutions must be found for ventilation openings which satisfy security requirements.

Control strategies must be developed to ensure that night ventilation does not result in an unacceptably cool building at the beginning of the day. There may also be spatial variations of indoor daytime temperatures, i.e. variations caused by the different locations of rooms or zones within a building. A room on the west facade of a building may be too cool during the early morning after night ventilation, whereas a room on the east facade may be at a comfortable temperature.

Simplified simulation tools are needed to build up confidence in the applicability of the proposed system designs. Design or computational tools for passive solar buildings are widely developed, but most of these are designed for heating purposes and cannot be used to simulate the summer performance of buildings.

Within the framework of the Building 2000 project of the CEC DG XII (Science, Research and Development), an extensive survey was carried out identifying the tools available for natural and low energy cooling purposes. It was found that 128 programs have some capabilities to calculate the cooling load of the building; however, only 54 of them can also calculate the variation in the internal air temperature and only 45 can also take into account the impact of mass and shading. Out of these 45, only 2 programs can also simulate natural ventilation strategies (reference: Natural and Low Energy Cooling in buildings, THERMIE Programme action, The European Commission Directorate - General For Energy (DG XVII), Rational Use of Energy, May 1994).

Some simplified tools exist for the designer; such as 'NORMA' which was made available to assist architects in the recent ZEPHYR competition, a European architectural competition for passive cooling systems. NORMA¹ is relatively user-friendly, but suitable only for initial assessments and typical applications – the program is primarily for designers and not researchers.

A simplified multi-zone cooling model has also been proposed by J. Van der Mass and C. A. Roulet to assist in calculating the potential for night cooling (reference: "Multizone cooling model for calculating the potential of night-time ventilation", by Van der Mass and Roulet, 14th Air Infiltration and Ventilation Centre Conference, 21-23 September 1993). Programs such as BREVENT, BREEZE (multi-zone), and AIDA (single zone), which model air flow in buildings may also assist in assessing the potential for night ventilation. The following table provides further information:

Program	Originator	Contact
BREVENT	Building Research Establishment (BRE)	Andrew Cripps BRE Garston, Watford UK WD2 7JR
BREEZE	Building Research Establishment (BRE)	Martin Smith BRE Garston, Watford UK WD2 7JR
AIDA	Air Infiltration Ventilation Centre (AIVC)	M. Liddament AIVC University of Warwick Science Park Sovereign Court Sir William Lyons Road Conventry UK CV4 7EZ

¹ NORMA was developed by Prof. M. Santamouris of the University of Athens in Greece. For more information on this program, contact the Energy Research Group, School of Architecture, University College Dublin, Richview, Clonskeagh Drive, Dublin 14, Ireland.

2. GROUND COOLING WITH AIR

by: Mark Zimmermann, EMPA - KWH, Switzerland

(This section is based on experience with a ground cooling system in an 8000 m² office and trade building near Zurich, Switzerland. Experience was gained during the construction and operation of this demonstration project with monitoring and computer simulation.)

Ground cooling with air systems work in conjunction with ordinary ventilation systems with supply and exhaust air. The system also works well with ventilation systems which have a low supply air demand (e.g. displacement ventilation). Outside air for ventilation is first sucked through an underground piping system. The piping system is ideally situated under the building's foundation and below the ground water level for generally the lowest installation costs and the best available soil temperatures. The fresh air is cooled down as it passes through the pipes and is used directly as supply air for the ventilation system during the cooling season.

During the cooling season, the air can be cooled down to approximately 18°C to 22°C. When the outdoor temperature is low enough (i.e. less than 22°C) the outdoor air bypasses the ground storage and is taken in directly from outside. This normally happens at night-time, but may happen during the day if temperatures are cool enough.

The system can also be used to provide heating in the winter. Outdoor air is pre-heated with the ground storage system before being passed through a heat recovery system which transfers heat from the exhaust to the supply air. The soil is thus used twofold for storage and can be seasonally regenerated. Furthermore, such a system prevents the icing of the exhaust air heat recovery exchanger during the heating season since the supply air is pre-warmed. As for cooling, if the air is warm enough (i.e. greater than 6°C) the ground storage system is bypassed.

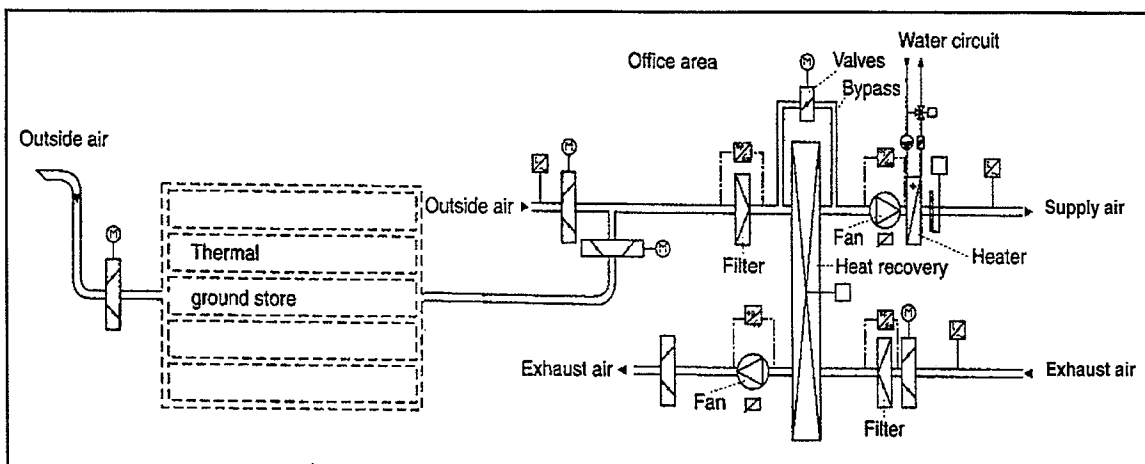

Figure 2-1: Schematic of an HVAC system with ground coupling

2.1 Applications

The system is suited to all mechanically ventilated buildings provided the installation of the piping system is feasible, in particular with regard to space requirements and ground conditions. Normally it is applied to commercial buildings (office buildings, shopping centers, schools) – residential buildings do not usually have the necessary mechanical ventilation systems. The system is best suited to office buildings with moderate cooling demand, since the system has a good peak performance but a limited seasonal cooling capacity. It is not suitable for meeting heavy cooling loads from machines such as in computer rooms. It is more suited for providing comfort cooling in low energy buildings which have a tendency to overheat in the summer. A low supply air demand is a prerequisite; otherwise the storage capacity of the ground is soon exhausted. As well, the buildings should have cold basements (i.e. no heat sources on the lowest floor).

No additional space is needed within the building for this technology. The amount of space needed outside the building depends on the ground conditions and the cooling capacity. In typical office buildings, with optimal ground conditions, approximately 25 m² of ground coupling area is required per kilowatt of peak cooling, or 1 m² per 5 m² of office floor area. An average length of 20 to 25 m is optimal for the pipes.

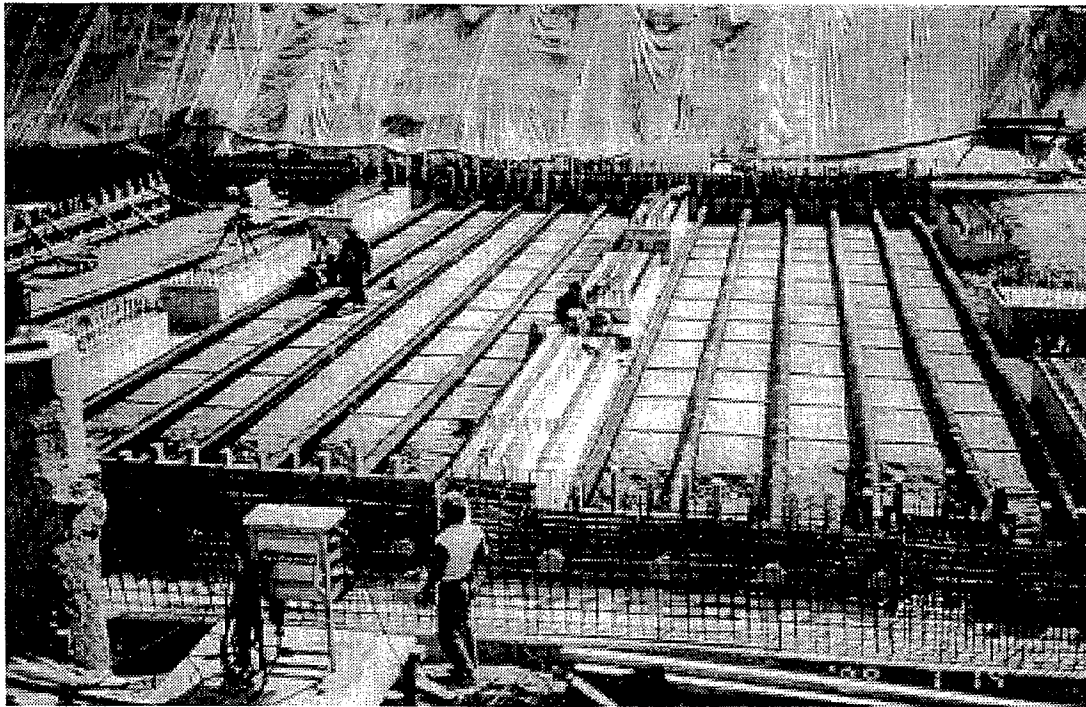

Figure 2-2: Piping layout during construction of a ground coupling system

It is best if the ground contains sand and gravel and the piping is close to, or below, the water level. Ground coupling is obviously very difficult on rocky ground and is not recommended in areas with radon gas. In areas with moving ground water, ground water temperatures of up to 15°C are suitable, since the moving ground water improves the performance tremendously due to replenishment of available cooling. It is important

though that the water is not stagnant because otherwise the water temperature will increase over time and cooling performance will suffer. Without ground water, the ground coupling area should be increased by about 30% and the average length of pipes should be about 30 m to achieve the same performance.

Ground temperatures² should be 12°C or lower and the possibility for night ventilation should exist. There is little experience with this system in warmer climates, but similar performance can be expected if the comfort expectations are shifted accordingly in relation to the ground temperatures.

2.2 Energy performance

Ground cooling provides primarily sensible cooling, but under certain conditions condensation may occur in the piping system resulting in some dehumidification. Ground coupling is typical of passive/hybrid systems in that it is energy efficient, but with some performance limitations (i.e. low seasonal cooling capacity relative to the available peak cooling). Nevertheless, the system performance is good when there is a large difference between ground and air temperatures, and the system is very reliable.

The following performance measurements were made for a ground cooling system in an 8000 m² office and trade building in Switzerland. The ground storage system for this demonstration project consisted of 1000 meters of 23 cm diameter piping over 1200 m² of ground coupling area. The system provides up to 54 kW of cooling. The ventilation rate for the ground coupling mode was about 0.75 ACH during the winter and 1.0 ACH during the summer. For the night cooling mode, which was used during the summer for about four months, the ventilation rate was about 2.0 ACH.

**Table 2-1: Energy performance
(per square meter of ground coupling area)**

Cooling Ambient air @ 32°C	Heating	
	Ambient air @ -5°C	Ambient air @ -15°C
45 W/m ²	45 W/m ²	65 W/m ²

**Table 2-2: Energy performance
(per square meter of floor area)**

Cooling	Heating
8 - 10 kWh/m ²	10 - 15 kWh/m ²

No additional fans are normally needed for this system, but an additional pressure drop of approximately 30 to 60 Pascal has to be taken into account due to the additional piping (assuming an air speed of 3 to 4 m/s). The additional electricity required to overcome the pressure drop amounts to about 11 W per kilowatt during peak cooling

² The average yearly air temperature is approximately equal to the ground temperature. (Refer to Appendix A for average yearly air temperatures for the countries participating in this annex.)

conditions (i.e. COP of 90). In the demonstration building, the total amount of electricity used annually for ventilation was about 2 kWh/m² of floor area per year for the ground coupling mode, which was used for both heating and cooling, and 3 kWh/m² for the night cooling mode (without ground coupling), which was used just for cooling during the summer.

2.3 Costs

The system costs are very much dependent on the actual project; a residential system would cost much less than the following costs. The following tables show the costs for the ground cooling system for the office building described in the previous section. The costs of the system are compared to a standard vapor compression air-conditioning system. The equipment costs associated with the air-conditioning system include the cost of the chiller, the electrical control equipment, and the cooling tower.

The equipment costs for ground cooling systems are minimal. Assuming that both cooling systems, in Tables 2-3a and 2-3b, use a standard ventilation system with heat recovery, the incremental equipment costs for ground cooling with air is for air inlet and connection pipes (of relatively minor value); these have been incorporated in the "Installation" cost category. The main cost for ground cooling is for excavating, back filling and required filters. There are no other major operating and maintenance costs associated with ground coupling systems and the life span of these systems is equivalent to that of the building.

Table 2-3a: Costs for a ground cooling system and for a standard air-conditioning system (ECU) - (Commercial Application)

Cooling System	Size (kW)	Equipment (ECU)	Installation (ECU)	Total (ECU)	Total (ECU/kW)
Ground cooling with air	54	0	160,000	160,000	3,000
Standard air-conditioning	50	88,000	22,000	110,000	2,200

Table 2-3b: Costs for a ground cooling system and for a standard air-conditioning system (US\$) - (Commercial Application)

Cooling System	Size (kW)	Equipment (US\$)	Installation (US\$)	Total (US\$)	Total (US\$/kW)
Ground cooling with air	54	0	180,000	180,000	3,300
Standard air-conditioning	50	101,000	25,000	126,000	2,500

The main advantage of the system is that it reduces the peak demands for cooling and heating. Not only does this reduce the energy costs, but it lowers installation costs of the rest of the HVAC system, since smaller equipment can be used. Based on the energy rates in Switzerland, the above system has a simple payback of 15 to 25 years

due to the lower installation costs for the rest of the HVAC system and the energy savings for cooling and heating.

2.4 Status

The technology is already used in several buildings (commercial, school and residential buildings) with good success, but more research needs to be done to optimize the system. Future research must improve the design of the storage system itself so that the dimensions of the air channels minimize costs while still providing good heat transfer and so that the pipes are accessible for maintenance purposes. Research must also classify soil properties and heat flux from the building in the ground so that the heat transfer potential of various ground conditions is understood.

There are several drawbacks to ground cooling systems becoming accepted. This technology has difficulty being accepted where mechanical ventilation systems are not normally used, such as schools and residential buildings in Europe. Technically, the system is primarily for new construction and in most cases would be too difficult to install as a retrofit measure.

Economically, this technology has – compared with active cooling – a relatively long pay back period. The initial investment costs are rather high but, it must be pointed out, that the system also has a long life span. The energy savings alone will not justify the investment cost, especially not at today's price levels, but the possibility of avoiding future investment and maintenance costs associated with air-conditioning equipment and the possibility of reducing the installed heating power can make the system feasible.

This technology is most likely to first gain acceptance in new low energy office buildings with moderate cooling loads and in climates with low ground temperatures (large summer/winter or day/night temperature swings). It works well with displacement ventilation systems. It may be applicable for buildings in the middle and northern Europe, middle and northern United States and in Canada, especially when alternatives to active cooling are promoted.

There are currently no design tools available for this technology. Engineers who have designed such systems have developed their own calculations from experience. Researchers in Switzerland are currently developing a model for ground cooling systems.

3. SLAB COOLING WITH AIR

by: K. Klobut and R. Kosonen, Technical Research Centre of Finland

(This section is based on a compilation of design, construction and running experiences gained from a limited number of experimental buildings recently constructed in Finland, in addition to computer simulations.)

The basic idea behind slab cooling is the exploitation of the thermal inertia of the building mass for the purpose of energy storage. The building envelope and both horizontal and vertical partitions are made of slabs. The channels in the slabs are used as ducts for the ventilation air. Whenever the temperature of the air passing through the ducts differs from the slab temperature, energy transfer takes place allowing the building mass to be used as a rechargeable energy store.

During the summer, the system can be run during the night (or whenever the outdoor temperature is lower than the indoor temperature) to store cool energy in the building mass. The "coolth" is then transferred during the day to the supply air, thus decreasing its temperature. Part of the conditioning process takes place in the ductwork, where the heat exchange takes place between the supply air and the building mass. Final conditioning may be left for terminal units.

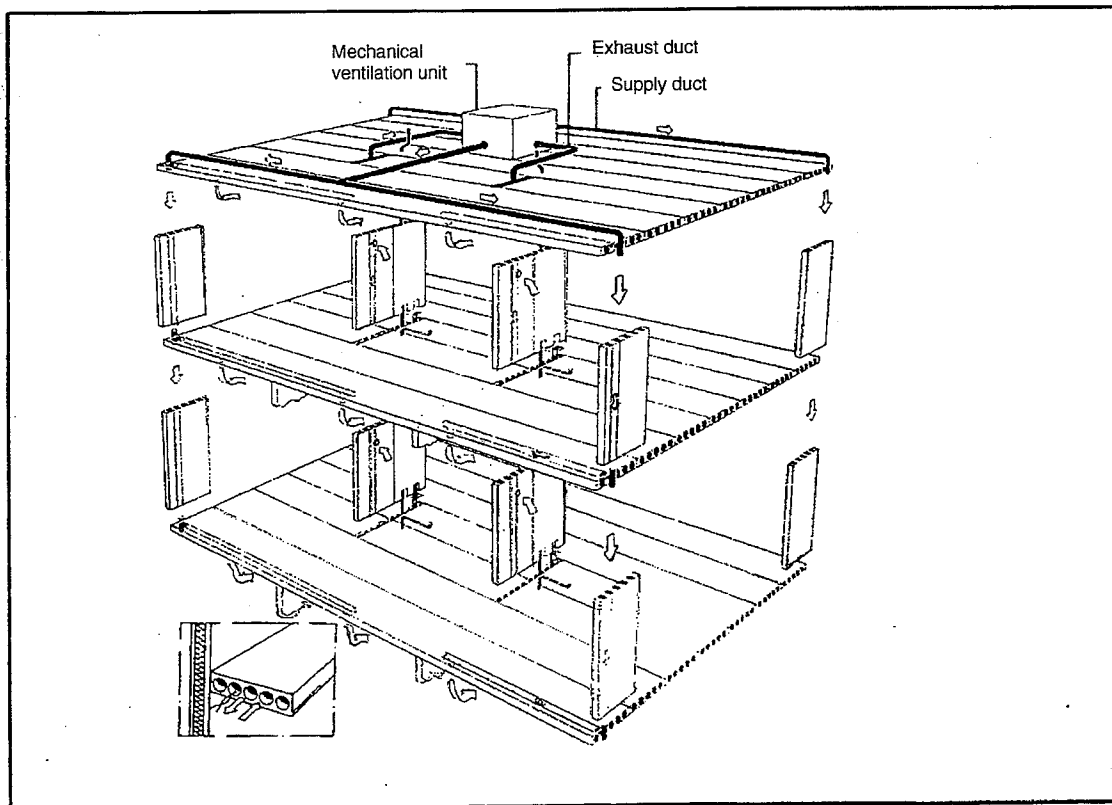

Figure 3-1: Air exchange ductwork integrated with the building construction
(reference: EBES, VTT publications, Number 537, Espoo, Finland, 1988)

The technology requires mechanical supply and exhaust ventilation. The ventilation control system controls the amount of cooling that happens during the night. This is normally done by controlling the air flow rates and timing of the night ventilation according to the indoor-outdoor temperature difference (Δt). Typically, the night-time ventilation would be increased when $\Delta t > 4$ K and switched to minimum ventilation when $\Delta t < 1$ K. Flow rates of between 3 to 4 L/s/m² are typical for slab cooling systems. In office buildings, which are unoccupied on the weekends, a slightly different control strategy might be used allowing the building to warm up slightly on Saturday. Slabs should not be cooled to less than 1°C above the lowest dew point expected throughout the day in order to avoid condensation.

The technology is an integral part of the ventilation system since channels in the slabs serve as the ducting for the ventilation air. In addition to channels being used for slab cooling, other channels in the slabs can be utilized to accommodate the water and sewage piping systems and electric wires. This provides a convenient way to integrate these systems with the building construction and keep them invisible without extra constructional effort.

3.1 Application

Slab cooling is not limited by the building type; it suits all sectors (e.g. commercial, residential, office, school, etc...). However, the technology is difficult to install after a building has been completed; hence, it is not suitable for retrofit applications unless a false floor system is added. Therefore, the decision to apply the technology should be made in the design stage and the technology should be implemented when the building is being constructed.

Ductwork for the air distribution system is incorporated within the building partitions. Two types of slabs exist for this purpose: hollow core slabs or prefabricated false floor systems. Some space may be required for the terminal conditioning units (such as heating coils), if such are used in the individual rooms. Space is also required in the plant room for the mechanical ventilation equipment (e.g. fans, heat exchangers, filters, etc...) unless this equipment is mounted on the roof.

Slab cooling provides sensible cooling only. Slab cooling can handle moderate sensible cooling loads and is particularly effective in cutting short load peaks. It is therefore suited best to moderate and moderate-dry climates where the daily outdoor temperature fluctuations are relatively high and where the night temperatures are lower than the indoor temperatures. It offers a convenient method for providing cooling comfort for buildings that tend to overheat in day-time during the intermediate seasons (spring and autumn). The system still functions in the summer, but the energy performance decreases as the night-time indoor-outdoor temperature differential decreases.

The cooling potential of the technology is strongly dependent firstly on the changes of the outdoor temperature and, secondly, on the building mass. The heavier the building construction the longer the periods of positive indoor-outdoor temperature differences required to charge the building mass with "coolth".

3.2 Energy performance

An average measured thermal performance of 1.2 W/L/s (including fan pick-up) of supply air was achieved in a small experimental low energy house, using cooling by night ventilation, with the average supply temperature about 1°C below the ambient temperature. These values are based on randomly taken measurements obtained during office hours. Long term measured data are not yet available.

Auxiliary energy, in the form of electricity, is required to drive the fans of the mechanical ventilation system. In a typical supply and exhaust ventilation system, the fans consume 3 to 6 W/L/s³ of supply air and about fifty percent of the energy is for overcoming the pressure loss in the ductwork. There is additional pressure loss in a slab cooling system due to the rougher ducts (roughness of 1.0 versus 0.15 for normal ducts) and to the connections between the vertical and horizontal ducts. All in all, this means that up to 30% more energy may be required for ventilation with slab cooling or up to 1.8 W/L/s of supply air. Assuming a cooling performance of 1.2 W/L/s, this would equate to a minimum seasonal COP of 0.7.

3.3 Costs

The life span of the slab cooling is expected to be comparable with that of the building itself. Maintenance costs do not differ from those of the traditional mechanical ventilation system.

Successful implementation of the technology requires:

- exceptionally detailed and precise design for the whole construction process,
- industrial prefabrication of some building elements, and
- skilful and responsible workforce on the construction site.

The exactness required in the design, the prefabrication of building elements, as well as the probable need for additional training of the workforce, may all result in an extended schedule and increased cost for the completion of the building. Part of this extra cost will be compensated by avoidance or limitation of the traditional cooling equipment. Ideally, a considerable fraction of the standard ventilation ductwork need not be installed because slab channels are used instead.

Further cost savings may be achieved by using the slab cooling channels for heating in the winter. Pulling the return air through the slabs to recover heat from it, and then using this energy to preheat supply air drawn through other slab channels, may be enough to maintain the indoor air temperatures in the building at a certain base value (e.g. 16°C - 18°C). Terminal devices with heating coils may then be used to adjust the supply air temperature to meet individual room requirements. Alternatively, an inexpensive electrical night tariff may be utilized for preheating the building structure with wires installed in other channels in the slabs.

³ It is possible though to design a fan system that consumes only 1.5 to 3 W/L/s.

3.4 Status

The technology is not fully developed yet. The limited experience that has been gained from systems functioning in experimental houses is encouraging, but long term measured data are still missing. The technology is likely to first gain acceptance in moderate climates for new, low energy houses, with mechanical ventilation and with moderate cooling loads, or in buildings where there is a periodicity in the occupancy and thus in the cooling load (e.g. offices, schools, theaters). The technology has a greater range of applications if combined with indirect evaporative cooling and night ventilation.

Indoor air quality issues, to be properly addressed, have to take into account the need for duct cleaning, and therefore, the incorporation of equipment to carry out such cleaning. One possible solution is to keep the open ends of the ducts covered until they are actually installed.

Work must be done to improve the joints between the floor and wall elements so as to reduce the pressure losses. Future research must also focus on improving the ventilation control strategies for this technology. The strategies are complicated due to the time lag in the system. Determining the optimum air flow rate requires satisfying both ventilation and cooling needs.

There are no specific design tools yet available for this technology. General energy simulation programs, such as ESP, TRNSYS or DOE-2, may be of some assistance for the general design of a slab cooling system, but they do not assist with the detailed design of the technology. A model developed by VTT in Finland and another model which is currently being developed in Finland allow one to conduct detailed studies of the heat transfer processes in a slab. These models though are quite sophisticated and require considerable skills to be used; they are more for research use than for a typical designer.

4. DESICCANT COOLING

by: Sophie Hosatte, EDRL/ CANMET, and N. Ben Abdallah, Dept. of Agricultural Engineering, TUNS, Canada

(This section is based on an extensive literature review.)

In a typical desiccant cooling application, moisture (latent load) from the process air is removed by a desiccant material in the dehumidifier. During dehumidification heat is released so that the dry-bulb temperature increases. The dry-bulb temperature (or sensible heat) is then reduced by an auxiliary cooling system (e.g. mechanical compression, evaporative cooling). Therefore, in a complete desiccant cooling system, latent and sensible energy are handled separately and more efficiently by components designed for that load. Such a system allows better control of the indoor dry-bulb and wet-bulb temperatures.

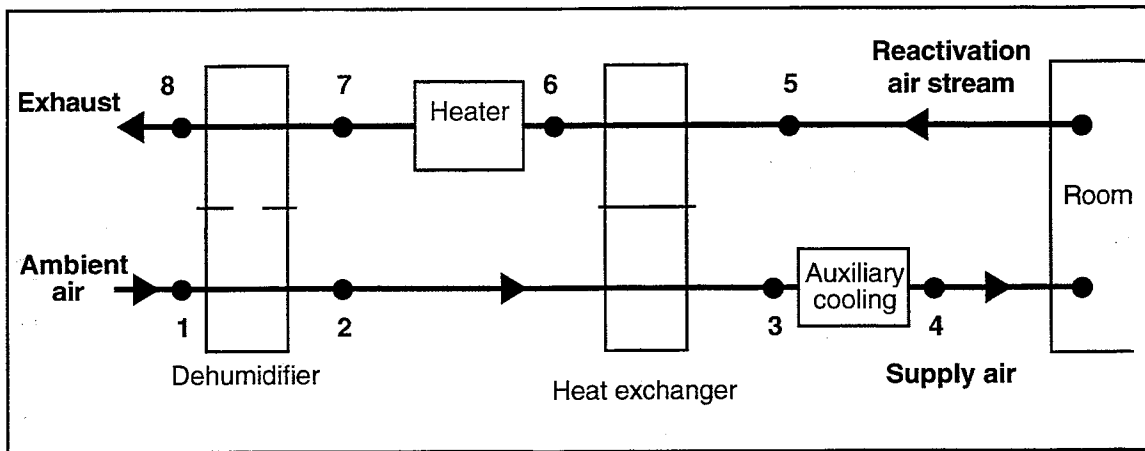
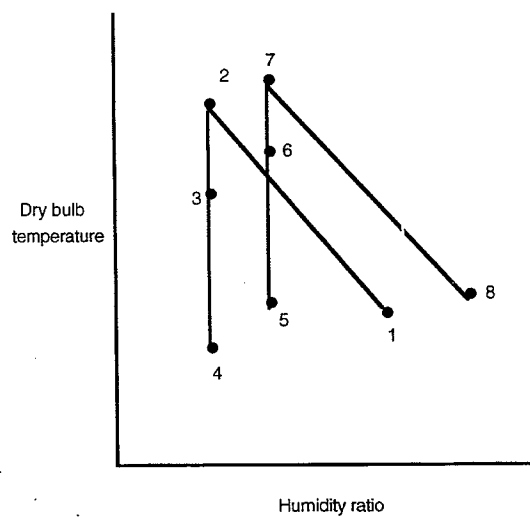
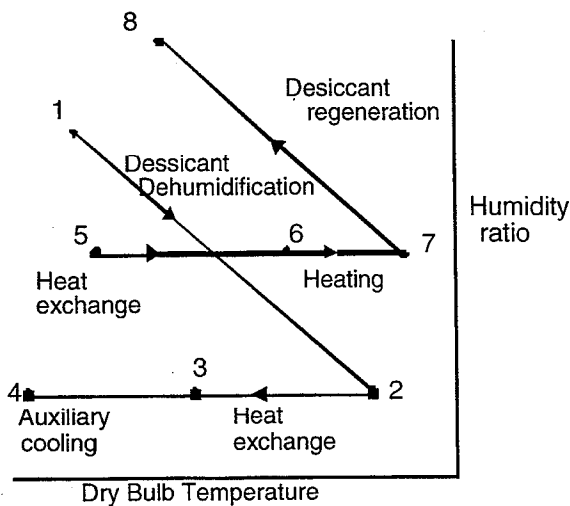

Figure 4-1: Schematic of a solid desiccant cooling system

Figure 4-2: Psychrometric representation of the solid desiccant system

a) ASHRAE chart

b) Mollier chart



Two types of desiccant systems exist: solid based and liquid based desiccant systems. In solid desiccant systems, air is circulated through porous material which removes the moisture by adsorption: water molecules physically attach to the surface of the material and then permeate into the solid by diffusion. Hot air is then used to regenerate the material. Solid desiccants are usually applied in the form of a packed bed or a rotating wheel. The most current solid desiccants are inorganic materials, e.g. silica gel, lithium bromide, lithium chloride, calcium bromide, molecular sieves and titanium silicate. Organic polymers are presently being investigated as the next generation of advanced desiccant materials.

In liquid desiccant systems, a concentrated solution is sprayed in the air stream to remove the moisture by absorption. The diluted solution is then circulated and heated by a hot air stream to reconcentrate the liquid desiccant. Examples of liquid desiccants are glycol and solutions of lithium bromide or calcium chloride in water.

Desiccant cooling control strategies depend on the accuracy required on the humidity level. It is very difficult to compensate quickly for rapid changes in moisture load with desiccant systems. Simple on-off humidistats or dew-point sensors are used when control of the humidity to within $\pm 5\text{-}10\%$ RH is acceptable. In liquid systems, a constant humidity may be maintained for the supply air by using a liquid level controller in conjunction with reactivation energy to maintain the solution concentration. For solid desiccant systems, packed beds are generally not used when close control of humidity is required. In rotary units, the humidity is controlled by regulating the activation energy or the rotational speed.

Desiccant cooling systems have the following benefits:

- improvement of indoor air quality – in addition to the desiccant cleaning the air as it dehumidifies it, some desiccants act as bactericides;
- capability of producing very low humidity levels;
- ability to use alternate energy sources and waste heat;
- minimal electrical consumption;
- capacity for Demand Side Management by shifting electrical consumption to a thermal source; and
- separate control of humidity and temperature.

The figures in Figure 4-2 show the psychrometric representation of the solid desiccant system shown in Figure 4-1. The reduction of the supply air's dry bulb temperature is done by an air-to-air heat exchanger between the reactivation air stream and the dehumidified ambient air. To decrease the supply air's dry bulb temperature even more, the reactivation air stream could first be cooled using direct evaporative cooling, prior to the heat exchanger. This would reduce the need for an auxiliary cooling system on the supply air side, although it would increase the amount of heat required to reactivate the desiccant.

4.1 Application

Desiccant cooling provides latent cooling only. The technology has emerged from industrial applications where low humidity levels are absolutely required. The technology is now developed and suited for the industrial, commercial and residential sectors but major applications are in the commercial and industrial sectors. Performance analyses have revealed a great potential in ice rinks, supermarkets, hospitals and motels where the technology may offer reduction of energy consumption or air quality improvements.

The technology requires no space outside the building and no particular geographical location, but to integrate the technology into an HVAC system requires space, the exact amount depends on the configuration of the dehumidifier matrix (e.g. packed beds or rotational wheel) and on the sophistication of the system (e.g. integration of humidifier pads, filters). Based on a review of commercialized systems, desiccant wheel diameters may range between 0.20 m and 2.10 m. The volume of the systems may vary between 0.1 m³ to 100 m³ for residential and industrial applications respectively. The volume also depends a lot on the other installed systems such as heat-exchangers, dampers and filters. Due to the amount of space required for this technology, it may be difficult to use in retrofit applications. The desirability of having adjacent supply and extract air streams may also prove a barrier to retrofit applications.

The technology is capable of satisfying small latent loads (in the residential sector for instance) up to very large latent loads (in the commercial and industrial sectors) and maintaining very low dew points. Commercialized desiccant systems can handle from a fraction of a liter per second of air up to 11,000 l/s and are capable of removing more than 3,600 kg of water per hour. Dew points as low as -65°C are possible, but these are not very common in air conditioning systems.

The technology is suited for hot or warm and humid regions. (This corresponds to regions C1, C5 and perhaps C4 in Canada.)

4.2 Energy performance

Energy performance is very dependent on the type of the dehumidifier (i.e. liquid absorbent, rotary bed absorbent or packed beds), on the system design (i.e. use of heat-exchangers for energy recovery) and on the system complexity (i.e. single- or double-stage dehumidifier). Reactivation energy must be provided by a thermal source (e.g. waste heat, solar energy, natural gas). Natural gas is the most commonly used source for economic reasons. Electricity is required to operate fans, pumps and produce wheel rotation.

The cost of this auxiliary energy is generally quite significant, but varies with the system design and the dehumidifier configuration – in general, packed beds require more auxiliary energy than rotary wheels. Overall COPs of about 1 have been achieved with current systems but, with the development of advanced desiccant materials and improved cycles, COPs above 1.7 may be achieved.

4.3 Costs

Savings with a desiccant-type dehumidifier compared to a conventional refrigeration system are highly dependent on local climatic conditions (latent loads versus sensible loads) and on utility rates (the cost of natural gas versus the cost of electricity). Desiccant systems may reduce energy demand costs since gas is used instead of electricity to provide the dehumidification.

The technology is reliable. Solid desiccant systems are more reliable and require less maintenance than liquid desiccant systems. The life span of the system depends mainly on the useful life of the desiccant. This depends on the material, on the process, and the magnitude of degradation which may result due to hydrothermal cycling and exposure to contaminants. Use of air filters helps to increase the life span of the dehumidifier.

In residential and commercial applications, according to manufacturers, system life times of between 10 and 20 years are expected. ASHRAE Fundamentals Handbook (Chapter 19) mentions that commercial equipment lasts between 10,000 and 100,000 hours of operation. In the applications where the air to be dehumidified is very contaminated, the dehumidifier may need to be replaced quite often.

The technology provides other cost benefits though, such as reduction in the sizes of ducts, fans and sensible cooling systems. In some cases, indirect cost benefits attributable to low humidity levels are provided by the technology (e.g. reduction of corrosion phenomena or of micro-organism growth).

4.4 Status

The technology based on solid desiccants is fully developed and is commercially available. Systems based on liquid desiccants are not yet fully developed and new liquid desiccants may be developed in the next few years. Performance improvements for both types of systems are expected in the next few years due to the development of advanced desiccant materials and advanced operating cycles. The technology is expected to become more compact and less expensive because of larger volumes of production.

The technology is mostly likely to first gain acceptance in warm or hot and humid climates, in buildings with mechanical ventilation systems, in the commercial and industrial sectors where latent cooling loads are high and significant, and in applications where thermal energy sources are available at a low cost relative to the cost of electricity.

The high capital cost for desiccant systems restricts the adoption of this technology. As well, there is apprehension in using a new technology. Little information is available on the technology, including tools to assist designers. Currently, manufacturers have developed their own design charts to select the proper size of the systems they commercialize. Charts developed by manufacturers are very simple to use but limited to a specific system. Simulation models are more suitable for the assessment of the performance of the technology.

Simulation models such as DOE 2.1E, TRACE and TRNSYS currently allow modeling of the energy consumed and the dehumidification provided by a desiccant cooling system in a building. (DOE-2.1E and TRACE are whole building energy simulation programs; whereas TRNSYS is more suitable for solar energy applications.) Several detailed models also exist for the dehumidifier matrix and simpler models for the overall system performance have been developed for research purposes. All of these simulation models are relatively complex to use and are more suitable for research scientists than designers. More universal design tools are required to facilitate designers' work.

5. EVAPORATIVE COOLING

by: Joe Huang, Lawrence Berkeley Laboratory, United States

(This section is based on review of off-the-shelf evaporative cooling systems, computer simulations, and bench-test data gathered by a California utility company. Most of the following description focuses on stand-alone residential evaporative coolers, with which the author has had more experience.)

In evaporative cooling, evaporation of water is used to decrease the dry bulb temperature of air.⁴ Wetted-pad media or water sprays may be used for evaporation of the water. There are two main categories of evaporative cooling: direct and indirect evaporative cooling. In direct evaporative cooling, water is evaporated directly in the air stream, reducing the air stream's dry bulb temperature, but increasing its absolute humidity.

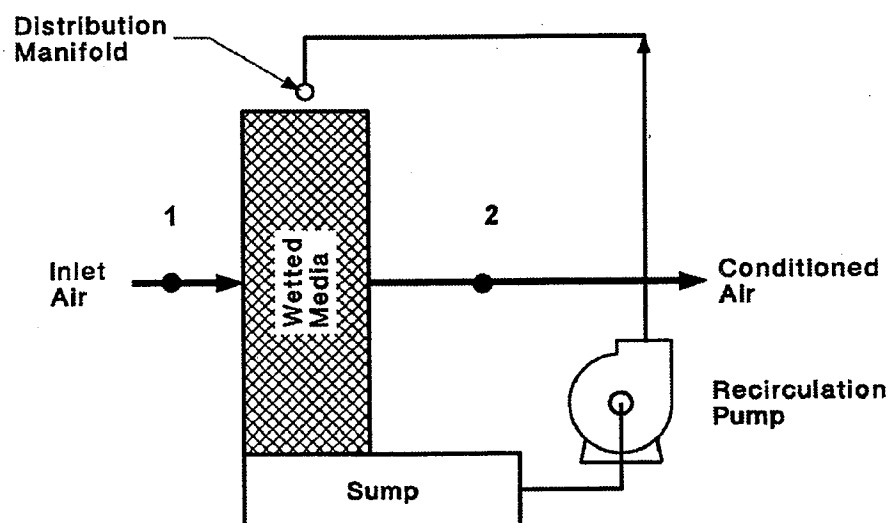

Figure 5-1: Direct evaporative cooling system

In indirect evaporative cooling, two air streams are used. (Refer to Figure 5-2.) A secondary (or scavenger) air stream is cooled directly using evaporation and then exhausted. The secondary air stream may be outdoor air or exhaust air. The cooler moist secondary air is used to cool the primary (or room) air stream indirectly through an air-to-air heat exchanger. When the secondary air stream is exhaust air, the heat exchanger can also be used to pre-heat outdoor air in the winter.

⁴ Cooling towers are not addressed in this chapter. Although they are also based on evaporative cooling, cooling towers differ from evaporative coolers in that their purpose is to cool water which may then be used to cool air.

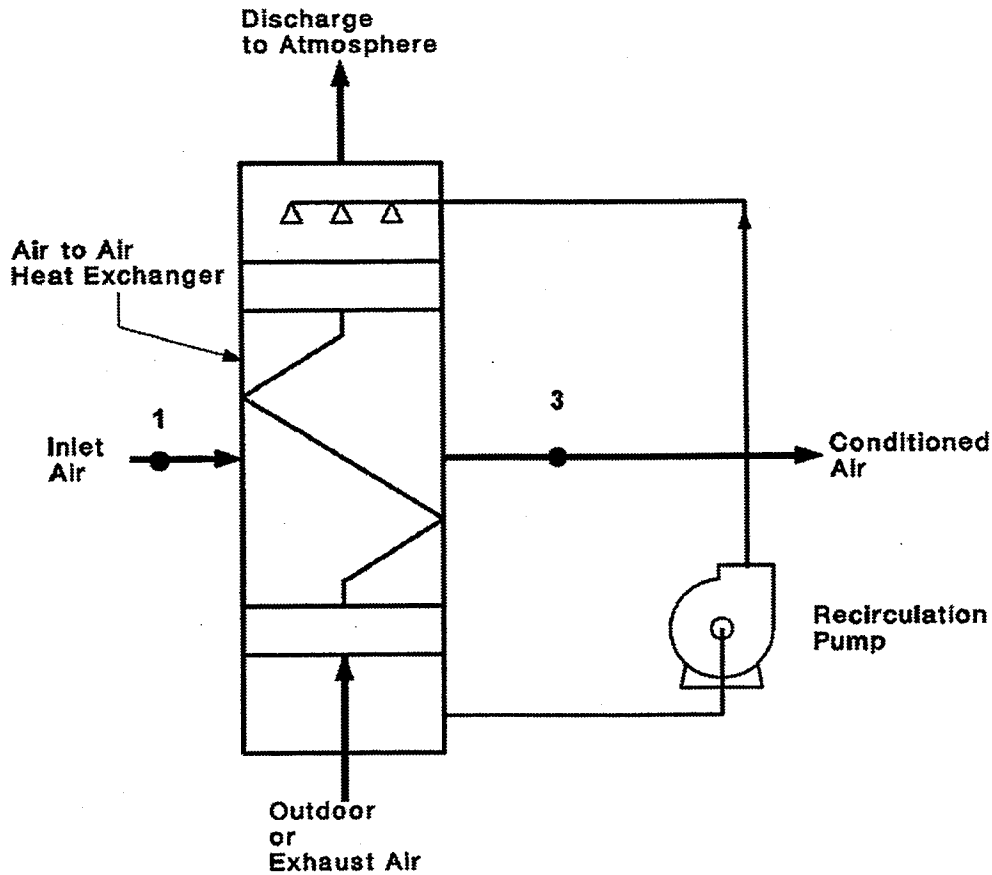

Figure 5-2: Indirect evaporative cooling system

Because of the limited cooling capacity of the indirect evaporative cycle, the primary air is often cooled again by direct evaporation. Such a two-stage system is called an indirect-direct system.

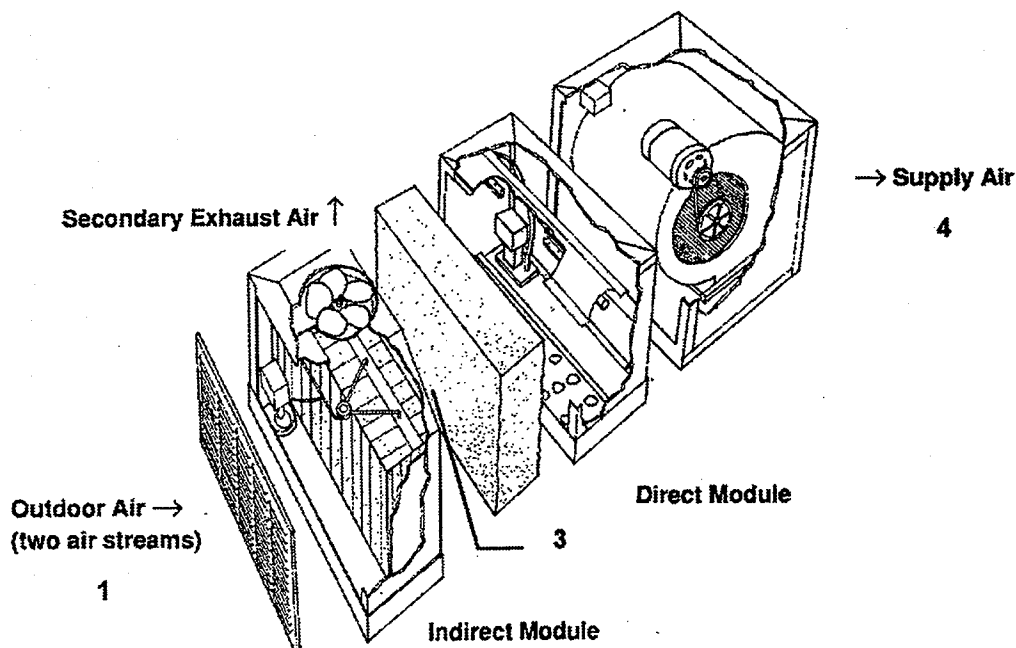

Figure 5-3: Two stage indirect/direct evaporative cooling system

When designed as a stand-alone system, an evaporative cooling system requires three to four times the air flow rate of a conventional air-conditioning system. Because of the higher air flow rates, larger ducts are required, but the higher air flow rates and absence of recirculated air may improve indoor air quality in some buildings due to better dilution of indoor air pollutants. In countries that prohibit the use of return air, direct evaporative cooling systems might be a cost effective alternative to conventional cooling.

Besides operating as a stand-alone system, indirect evaporative cooling systems can be integrated with conventional air conditioning systems to pre-cool the air using standard air flow rates. Depending on the climate, evaporative cooling can also be used to boost night-time cooling by further reducing the air temperature.

5.1 Applications

Evaporative cooling is most appropriate in buildings with relatively small cooling loads, such as small commercial and residential buildings; or buildings that do not require tight humidity and temperature control, such as warehouses and wholesale stores. Indirect evaporative precoolers may be beneficial in any commercial building requiring significant amounts of outside air, such as hospitals. Evaporative cooling can be used in retrofit applications provided that ducting requirements can be met and potential conflicts with the existing HVAC system are addressed.

Evaporative coolers are significantly larger than conventional HVAC units for similar cooling capacity. Moreover, there must be sufficient space for the larger air ducts. As well, some residential units that are mounted on the side of the house will require additional space. Evaporative cooling systems work best in open-plan spaces with few obstructions to air flow.

Under certain climate conditions (i.e. high wet-bulb temperatures) evaporative cooling systems will not deliver the required cooling; these systems are basically ineffective in humid locations. Direct evaporative cooling is only suitable for dry moderate climates with small cooling loads. (In the United States, such climates exist in the Mountain states or slightly inland locations in California.) Two-stage models can extend the applicability of evaporative cooling to locations with hot-dry climates (such as in the state of Arizona in the United States) or moderately hot climates with moderate levels of humidity.

Direct evaporative cooling provides sensible cooling while increasing the latent heat content of the air (i.e. humidifies the air). Indirect evaporative cooling provides sensible cooling without increasing the latent capacity of the air. (Refer to Figure 5-4.) The lowest temperature that theoretically can be achieved in an indirect system is the dew point temperature of the secondary air stream. As a result, evaporative cooling can meet moderate sensible cooling loads under dry conditions with no latent cooling loads. It cannot address latent cooling loads and may increase them if improperly applied.

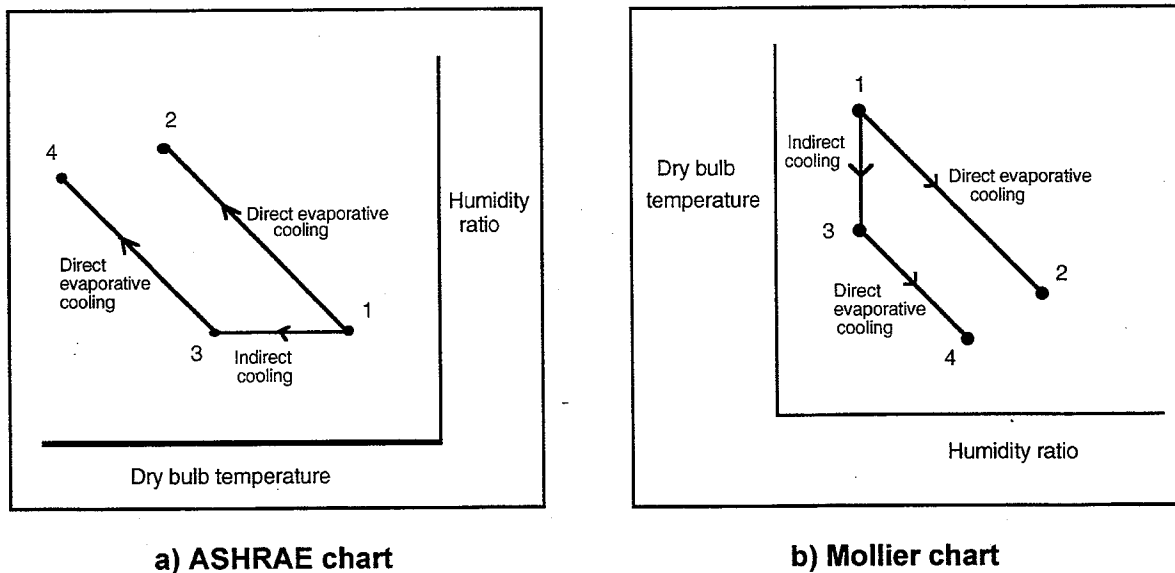

Figure 5-4: Evaporative cooling processes on the psychrometric chart

5.2 Energy performance and water usage

The only energy costs in evaporative cooling are for the electricity for the fans and water pumps. For a direct evaporative cooler, 250 W of fan power are required for every 1000 L/s of air. For a two-stage indirect/direct evaporative cooler, 600 W are required. The electricity consumption of the pump is from 60 to 100 W for the same amount of air movement.

The cooling capacity of evaporative cooling varies tremendously with the ambient air conditions, in particular the wet-bulb depression.⁵ In semi-dry climates (such as in the state of California in the United States), indirect/direct evaporative coolers use on

⁵ The wet-bulb depression is the difference between the dry-bulb and the wet-bulb temperatures.

average 250 watts to produce and deliver 1 kilowatt of cooling (COP of 4). Direct evaporative coolers use on average 150 watts for 1 kilowatt of cooling, provided that they can meet the cooling load (COP of 6.7).

This technology also consumes water. Computer simulations show that a two-stage indirect/direct cooler will consume 25 000 litres per year of water to meet a cooling load of 13.7 gigajoules in a dry, hot climate (such as in Fresno, California in the United States). The average water consumption for several different climates was calculated to be 1.3 L/MJ of cooling for a direct system and 1.5 L/MJ for a two-stage evaporative cooler load.⁶

5.3 Costs

A typical 2000 L/s (4600 cfm) direct evaporative cooler by itself costs 350 to 440 ECU (US\$ 400 to 500). Compared to a standard (vapor compression) air-conditioning system, the equipment costs for a direct evaporative cooler are one third as much and for an indirect/direct they are about two thirds as much. However, installation is more expensive with evaporative cooling systems because workers are unfamiliar with the system. A fully-ducted and installed direct evaporative cooler costs 1330 ECU (US\$ 1500), or about fifty percent of the cost of a standard air conditioning system installed, and an installed two stage system would cost about seventy percent of the air conditioning system.

Table 5-1a: Costs for evaporative cooling systems and a standard air-conditioning system (ECU) - (Residential Application)

Cooling System	Cooling capacity ⁷ (kW)	Equipment cost (ECU)	Installation cost (ECU)	Total cost (ECU)	Total cost per kW (ECU/kW)
Direct evaporative cooler	4.0	375	840	1330	333
Indirect/direct evaporative cooler	5.2	665	980	1645	316
Standard air-conditioning	12.3	1060-1330	1330-1600	2660	216

⁶ Values are based on sixteen cities in the state of California which fall into the US2, US5 and US6 climate zones. Refer to Appendix A for more information on these climate types.

⁷ The cooling capacity for an evaporative cooler is very climate dependent. The values given in these tables are averages and assume that the systems are being operated in climates appropriate for the technology.

Table 5-1b: Costs for evaporative cooling systems and a standard air-conditioning system (US\$) - (Residential Application)

Cooling System	Cooling capacity ⁷ (kW)	Equipment cost (US\$)	Installation cost (US\$)	Total cost (US\$)	Total cost per kW (US\$/kW)
Direct evaporative cooler	4.0	450	950	1500	375
Indirect/direct evaporative cooler	5.2	750	1110	1860	358
Standard air-conditioning	12.3	1200-1500	1500-1800	3000	244

Evaporative cooling systems require more maintenance than conventional air-conditioning systems, but those costs are difficult to estimate. The extra maintenance is for preventative care needed to drain the system and flush the wetted media to prevent the accumulation of mineral deposits. This is particularly important when the evaporative cooler is turned off at the end of summer. If properly maintained, the mechanical reliability of these systems is on a par with conventional air-conditioning systems. The life span of this technology is comparable to conventional air-conditioning (i.e. 20 years with good maintenance).

Indirect evaporative coolers can also reduce heating energy costs. The air-to-air heat exchanger used in an indirect evaporative pre-cooler can be used to provide heat recovery during the winter, thereby reducing the heating load for ventilation by up to 80%.

5.4 Status

There is a small evaporative cooling industry in the U.S., but the technology is not well developed. Although a great deal of design information already exists (reference: "The Handbook on Evaporative Cooling", J.R. Watt, Chapman & Hall, New York, 2nd edition, 1986), further work is needed to develop design guidelines, improve controls systems, optimize engineering designs for specific climates and building applications, and develop hybrid systems that work in tandem with other systems to produce better cooling reliability.

Evaporative coolers were stigmatized in the U.S. by their poor performance and reliability when they were first introduced in the 1930's. They were known as "swamp coolers" and regarded as providing a lower level of comfort than air-conditioning. In recent years, there has been some concern that evaporative cooling systems might cause legionnaires' disease.

Although the original outbreak of the legionnaires' disease was traced to legionella bacteria in a cooling tower, people should be aware that, unlike cooling towers, evaporative coolers have a low risk of causing the disease due to the lower water temperatures and the size of water droplets released by evaporative coolers (reference: "Why evaporative coolers have not caused legionnaires' disease", by P. R. Puckorius,

P. T. Thomas and R.L. Augspurger, ASHRAE Journal, January 1995, Vol. 37, No.1, pp. 29-33). The technology continues to be hampered though by the small industry base, resulting in slow technical improvements and higher costs.

Evaporative cooling has gained acceptance in selected applications such as wholesale stores. It has also gained acceptance, to some extent, in residences in arid locations in the United States, such as in the Mountain states (like Utah and Colorado) and in the Southwest (e.g. Arizona, New Mexico, and parts of California). Hybrid systems such as indirect precooling systems are still of limited application. One kind of hybrid system that seems to be gaining popularity in the southern United States is to use the evaporative cooling system to cool the condenser for a standard air-conditioning system. The benefits are lower electricity peaks and energy costs due to the evaporative cooling while still providing maximum comfort even when the outdoor air is very hot and humid.

Design tools have been developed by individual manufacturers and evaporative cooling designers. There is no general design tool that is widely accepted by HVAC engineers. One company has produced a proprietary PC program for their residential models with binned weather data for over 200 U.S. locations. This program is for designing and assessing the performance of the two-stage residential evaporative cooler marketed by that company and was written for the general practitioner.

Lawrence Berkeley Laboratory (LBL) in the United States has developed several detailed models for analyzing the performance of indirect evaporative coolers under different air conditions and flow rates. The models have been incorporated into a developmental version of DOE-2 that can simulate both stand-alone and hybrid systems with air-conditioner backup. This developmental program, however, requires a high level of familiarity and is suitable only for researchers. Concurrently, the public version of DOE-2 has also been expanded to include performance-based models for evaporative coolers and precoolers. It is anticipated that the results from the research program will be incorporated into the public version of DOE-2 in the near future.

6. SLAB COOLING WITH WATER

by: Christian Feldmann and Eric Michel, COSTIC, France
E. Maldonado and J. L. Alexandre, DEMEGI, Portugal

(This section is a combination of two separate reports submitted by France and Portugal. The report from France is based on tests in a climatic cell and a general survey of 180 actual installations in France. The survey was carried out by interviews with designers, installers and users. Twenty-six installations were visited. The report from Portugal is based on a literature review, computer simulations and experience gained during the design of a building using this technology for cooling.)

An installation of slab cooling with water is similar to a radiant floor heating system. In fact, the installation may be used for heating as well. The technology requires that a pipe network be embedded in a floating slab that is about 7 cm thick and located on the bearing slabs. The basic idea behind the technology is to take advantage of the high thermal inertia of the building concrete slabs for energy storage.

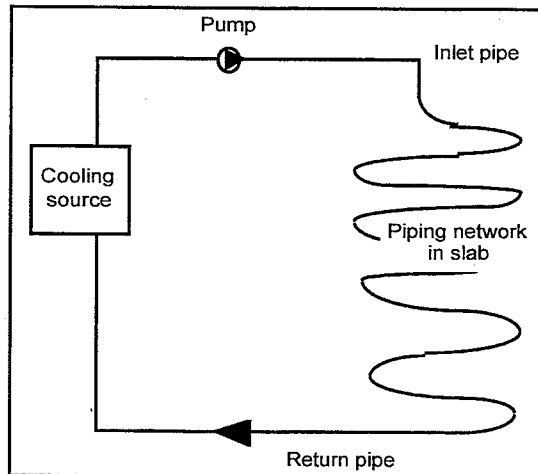

Figure 6-1: Schematic of a slab cooling water system

Energy transfer takes place whenever the temperature of the water passing through the pipes is lower than the temperature of the slab; which, in turn, is colder than the indoor ambient air temperature. The water flows in a closed-loop circuit and may be cooled by any one of the following cooling sources:

- an air-to-water heat pump with a reversing cycle (the most common),
- a water-to-water heat pump with a reversing cycle,
- a water chiller,
- a cooling tower,
- an absorption gas chiller, or
- a heat exchanger on the water table.

One type of control strategy that can be used with this technology is to hold the temperature of the water input to the floor slabs constant between 15°C and 18°C. When a cooling tower is used, another possible control strategy is to have the water flow only when the cooling tower is capable of producing cold water (i.e. the water temperature leaving the cooling tower is colder than the mean slab temperature) and the indoor air temperature is above a minimum comfort threshold. These conditions typically occur at night. Hence, slab cooling can be operated as a form of night cooling, charging up 'coolth' at night and absorbing heat gains during the day when the cooling loads are larger.

Whatever control strategy is used, the following conditions should be met:

- the slab temperature should not fall below the dew-point of the indoor ambient air temperature in order to avoid condensation;
- the difference between the surface temperature of the slab and the indoor ambient temperature should not exceed about 4°C to avoid uncomfortable radiant temperature asymmetry; and
- the indoor ambient temperature should not fall below a pre-defined level for comfort (e.g. 22°C to 23°C).

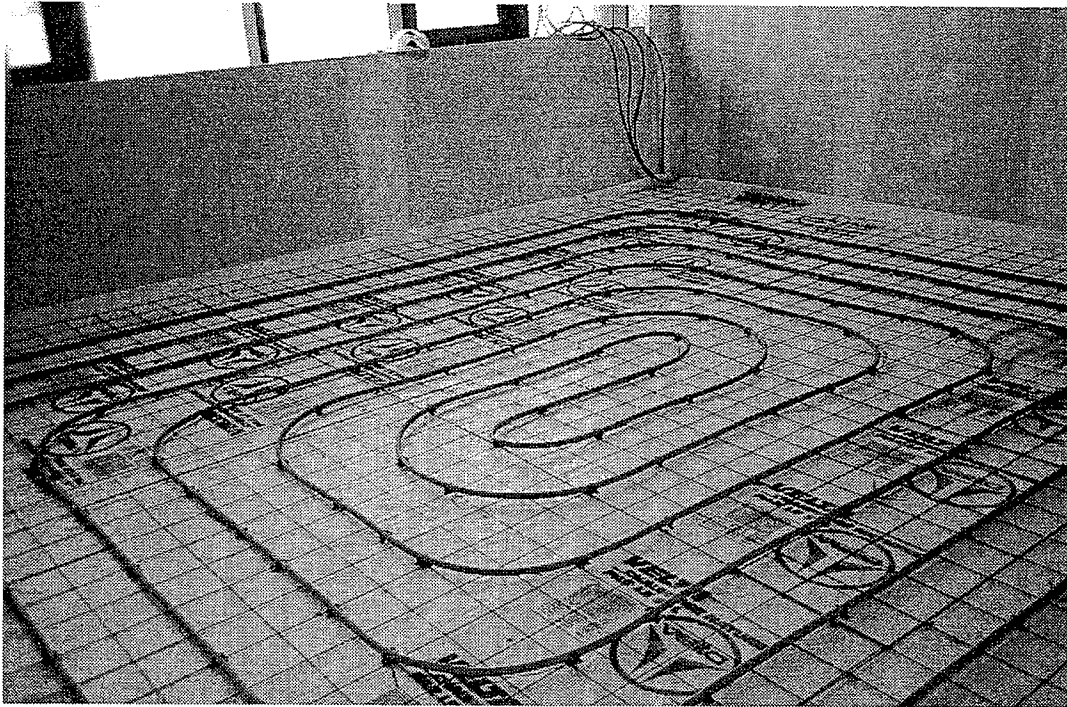

Figure 6-2: Slab cooling piping network before being embedded in concrete

The sensible cooling provided by slab cooling may be operated in conjunction with a mechanical ventilation system. Ideally, the mechanical ventilation system would have an economizer or free-cooling mode of operation so that cool air could be brought in at night to cool down the interior building mass. This works well in buildings that are unoccupied during the night since high air flow rates can be used.

6.1 Application

The technology is applicable for any type of building, although it is suited best to buildings with moderate internal gains. On its own, this technology provides only sensible cooling (maximum 30 to 40 W/m²) and hence is not suitable for climates with high humidity. For practical use of this system, the outside air dry bulb temperature should be less than 34°C and the humidity ratio should be less than 15 g/kg.

The technology performs very well in nonresidential buildings where night cooling can enhance the performance. The technology may also be used in residential buildings. In

fact, about 60% of the existing installations in France are in houses and most of these are connected to heat pumps or chillers.

6.2 Energy Performance

The energy performance of the system depends upon the specific system (i.e. the type of cooling source used, climate and size of system). If carefully designed, the technology can be quite effective.

In a residential application with about a 5 kW cooling system, a 100 W pump is required to circulate the cold water through the system (i.e. COP of 50 for delivering the cooling). If an air-to-water heat pump is used, 0.3 to 0.5 kW of electricity is required to produce one kilowatt of cooling (i.e. COPs of 2 to 3.3 to produce the cooling). This includes the 100 W fan required to cool the heat pump condenser. In total then, COPs of about 1.9 to 3.1 can be achieved with this technology using an air-to-water heat pump as the cooling source.

In systems that use cooling towers as the primary source of cooling, the COPs may be higher, but would depend on the climate. A detailed simulation would be required to determine the seasonal COPs for these systems.

6.3 Costs

The reliability of the technology is good due to the fact that it consists of a combination of well-trying components (i.e. pumps and piping common to radiant heating systems). Maintenance costs are small. For a residential application, the maintenance costs, including the maintenance for the cooling source, are between 3.50 to 7 ECU/m²/year (4 to 8 US\$/m²/year), as compared to 12 to 30 ECU/m²/year (14 to 34 US\$/m²/year) required for a conventional cooling system with air coils.

The life spans of current systems are comparable to those of floor heating systems. Long life spans are possible if connections are made accessible and all in one place. If necessary, pipes can be cleaned by passing a sludge through them. Plastic piping is currently available which has a minimum expected life span of thirty years and can be repaired by passing a solution through the piping.

The following tables show the equipment and installation costs for a 5 kilowatt residential slab cooling with water system for a 120 m² house. For adding a cooling system to an existing slab heating system, the costs are for the chiller and the control system. When adding a cooling and heating slab system in new construction, the costs also include the piping network and installing it in concrete slabs. Additional savings could be achieved by using a heat pump with a reversing cycle so that the same equipment could be used to heat the building during winter and cool it in the summer.

Table 6-1a: Costs for a residential slab cooling with water system (ECU)

Type of system	Cooling Capacity (kW)	Equipment and Installation (ECU)	Total per kW (ECU/kW)
Adding cooling to an existing slab heating system	5	6 200	1 240
Installing a cooling and heating slab system in new construction	5	11 310	2 260

Table 6-1b: Costs for a residential slab cooling with water system (US\$)

Type of system	Cooling capacity (kW)	Equipment and Installation (US\$)	Cost per kW (US\$/kW)
Adding cooling to an existing slab heating system	5	6 990	1 400
Installing a cooling and heating slab system in new construction	5	12 740	2 550

6.4 Status

The technology is not fully developed. Future technical improvements are expected in the control of the system. The technology is still expensive and no specific guidelines or programming tools are available for the design or installation of these systems. Designs must be based on general building simulation programs such as ESP, DOE-2 and TRNSYS. Although these programs can be applied to a full range of building types and HVAC systems, they are not very user friendly and are suitable only for trained experts.

Like any new HVAC technology, this technology is slow to be adopted because of designer resistance for fear of liability and extra design work resulting from unfamiliarity with sizing procedures. The technology is most likely to gain acceptance first with high-end individual houses and small office buildings with moderate solar and internal heat gains.

7. CHILLED CEILINGS AND DISPLACEMENT VENTILATION

by: K.-D. Laabs and Berthold Mengede, Germany

(The following section is based both on an extensive literature review and on experience from designed and installed systems.)

A cooling system based on chilled ceilings and displacement ventilation separates the latent cooling from the sensible cooling. The purpose of the displacement ventilation is only to provide the supply of fresh air and control the humidity. Thus the air exchange rate can be reduced to the minimum required for indoor air quality purposes. With these lower flow rates there is less pressure drop in the ducting and both the ducting and the air handling equipment can be sized smaller than for a conventional variable air volume (VAV) HVAC system.

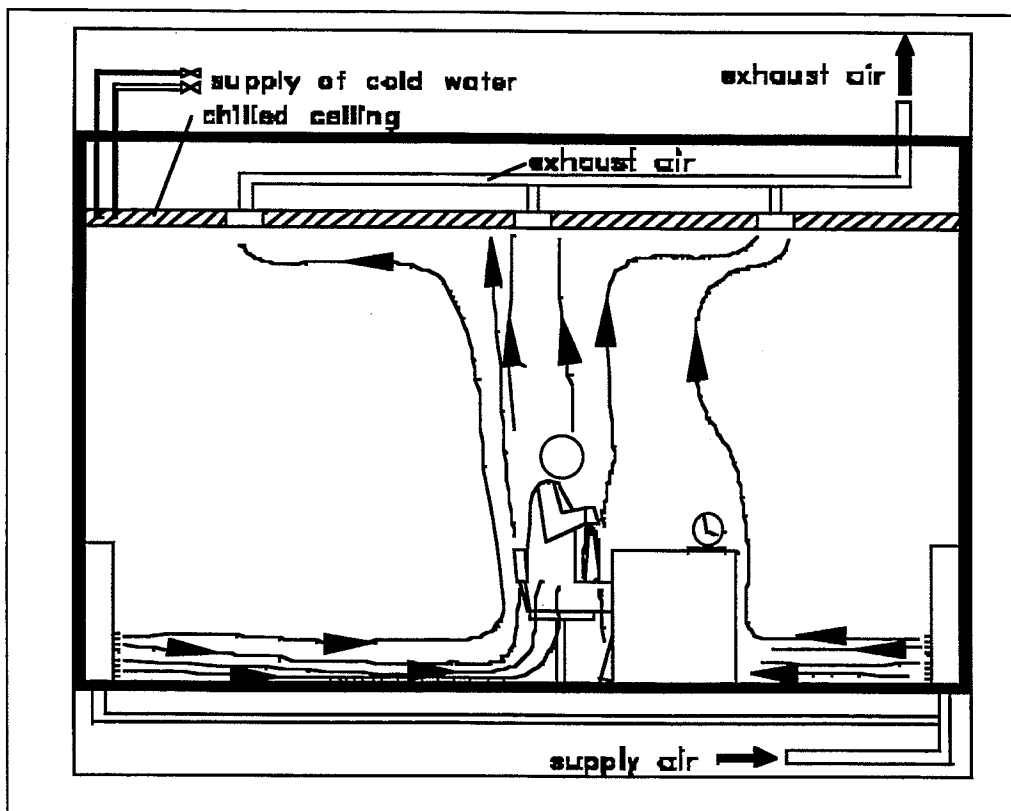

Figure 7-1: Cooling system using chilled ceilings and displacement ventilation

In displacement ventilation systems air is supplied at inlets near the floor. The supply air temperature is about 18°C and the air velocity is about 0.20 m/s. A layer of supply air spreads across the floor and is greatly affected by the buoyancy in the vicinity of internal heat sources. Warm air will rise around these heat sources and will then be exhausted near the ceiling. The result is a very effective ventilation system that delivers supply air directly to the regions that need it the most (i.e. heat sources and people).

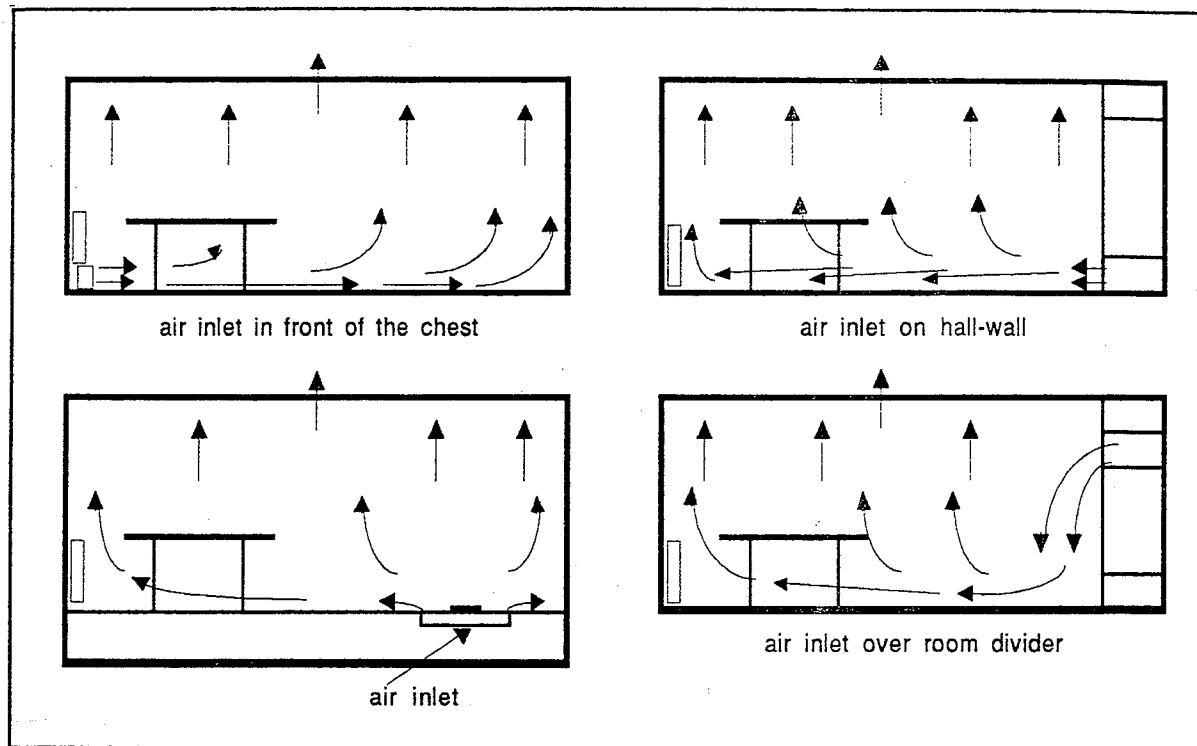

Figure 7-2: Various configurations for air inlet for displacement ventilation

The main part of the cooling is delivered to the room by the chilled ceiling. Cooling is transferred to the room via radiation and/or convection – the relative proportions of each heat transfer mechanism depends on the design of the chilled ceiling. A ceiling with a closed surface involves primarily radiation for the heat transfer and is referred to as a radiation ceiling; whereas a convective ceiling is more open.

A closed-loop circulates water through the ceiling. The water inlet temperature is usually between 16°C to 18°C. The room temperature is controlled by changing the water flow rate and/or the water inlet temperature. Dew-point sensors may be installed to avoid condensation by increasing the inlet water temperature or reducing the water flow rate. The cooling source for the water loop can be provided by any number of sources much the same as the slab cooling with water technology described in the previous section.

7.1 Applications

This technology is suitable for new and retrofit commercial buildings in any climate. Chilled ceilings with displacement ventilation, or “silent cooling”, can provide both latent and sensible cooling and these can be controlled separately. Up to 100 W/m² of sensible cooling can be provided by the chilled ceiling and additional sensible and latent cooling can be provided by the ventilation system depending on the supply air conditions and the air flow rate. The cooling performance of the chilled ceilings is very flexible so that a wide range of sensible cooling loads can be achieved without any changes to the system design.

The only restriction to applying this system is that the building design must allow space for the installation of the chilled ceiling, the exact amount depends on the design of the ceiling.

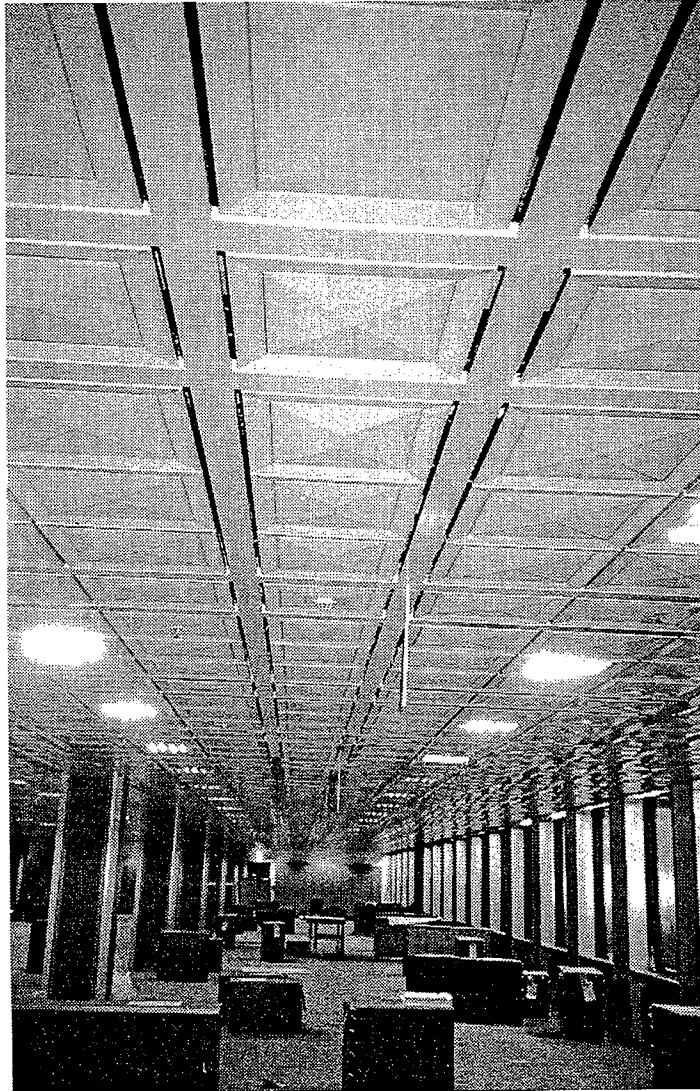

Figure 7-3: Experimental office building with a “silent cooling” system

7.2 Energy Performance

Typically mechanical cooling systems would be used to produce the cooling, although the warmer air and water temperatures used in this technology allows the use of passive cooling sources such as evaporative cooling or ground cooling. Due to the separation of latent and sensible cooling loads, cooling is provided at two different temperature levels.

The dehumidification of the supply air requires chilled water at 8°C to 12°C. Using vapor compression, about 250 to 330 W of electricity is required to produce 1 kilowatt of latent cooling (i.e. COP of 3 to 4). Producing the chilled water at 16°C to 18°C for the chilled ceilings by vapor compression would require about 180 to 250 W of electricity per kilowatt of cooling (i.e. COP of 4 to 5.5).

The amount of energy required by the fans and pumps to deliver the cooling to the building depends on the design of the total system and building, but it is less than for a conventional VAV HVAC system.

7.3 Costs

The following tables give the installation and equipment costs for several variations of the technology and compare these to the costs for a conventional VAV HVAC system. There would be essentially no difference in maintenance costs amongst these systems. The systems are very reliable especially if dew-point sensors are integrated to avoid condensation. The life span of the technology is similar to that for a conventional HVAC system, about 20 to 30 years.

Table 7-1a: Costs for chilled ceilings with displacement ventilation systems (ECU) - (Commercial Application)

System Type	Installation and Equipment (ECU/m ²)
Chilled ceilings with free convection (i.e. no displacement ventilation)	155 - 310
Displacement ventilation	80 - 155
Chilled ceilings with displacement ventilation	230 - 465
Conventional VAV HVAC	130 - 285

Table 7-1b: Costs for chilled ceilings with displacement ventilation systems (US\$) - (Commercial Application)

System Type	Installation and Equipment (US\$/m ²)
Chilled ceilings with free convection (i.e. no displacement ventilation)	175 - 350
Displacement ventilation	85 - 175
Chilled ceilings with displacement ventilation	260 - 525
Conventional VAV HVAC	145 - 320

7.4 Status

Many new chilled ceilings systems were developed during the last few years and they are now available on the market, but they are not yet fully developed. More development must be done, especially with the combination of displacement ventilation with different chilled ceiling designs, to examine the effect of different operating parameters on air flow patterns and overall energy performance. The main barrier to the acceptance of the technology is its relative high capital cost (i.e. installation and equipment cost). Developments of new chilled ceiling configurations must focus on reducing the cost of the system.

Another factor that would improve acceptance of the technology would be better tools to assist designers. There are highly sophisticated models available, such as computational fluid dynamic code, which describe the heat transfer at chilled ceilings by radiation and convection, but they cannot be used as design tools because they are too complex and the calculation results are not reliable. There are separate design charts and guidelines for different chilled ceilings and different displacement ventilation systems, but there are no design tools for the full range of potential applications. In addition, none of the design tools take into consideration the interactive effects between the air flow patterns caused by the displacement ventilation and the cooling performance of the chilled ceilings.

8. GROUND COOLING WITH WATER USING AQUIFERS

by: Hendrik C. Roel, Coman Raadgevende Ingenieurs BV, The Netherlands

(This section is based on experience with the technology in actual installations.)

It is possible to use groundwater cooling wherever it is possible to store cold and/or heat in aquifers and where there is a difference in summer and winter climates. The basic functioning of such a system is shown in figure 8-1. A ground water cooling system consists of two or more wells drilled in the sand bed.

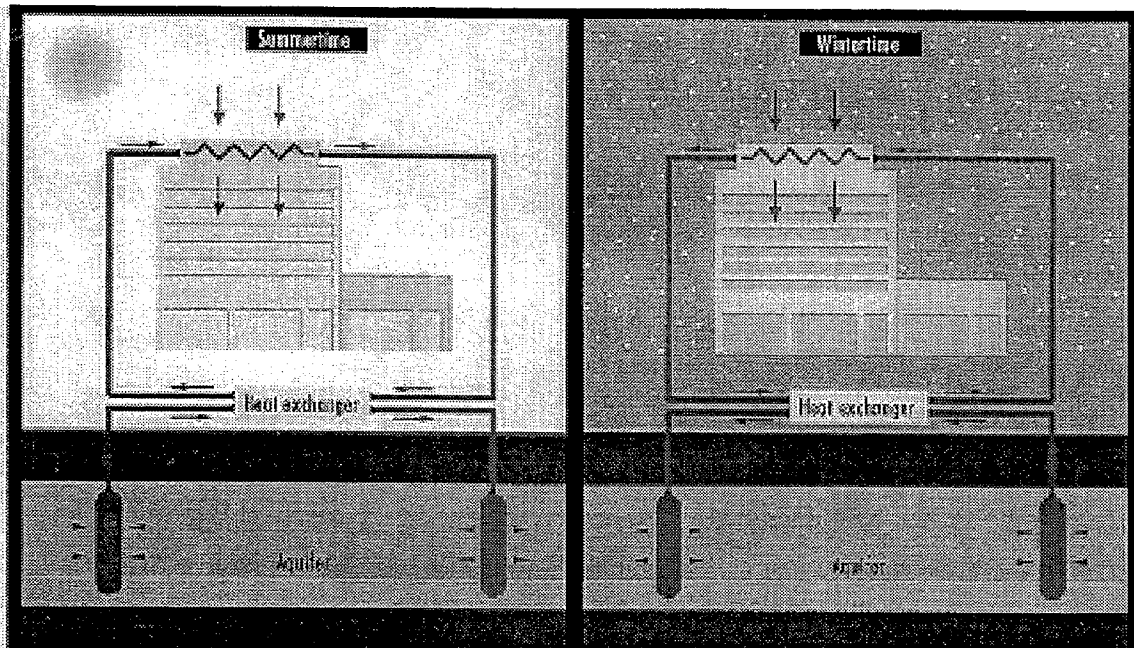

Figure 8-1: Schematic of a ground cooling with water system

In summer, when there is a demand for cooling, the cold (6°C to 10°C) groundwater from one of the wells is pumped up and passed through a heat-exchanger. The cold water is used to cool a water loop which runs through the building. The building water loop cools the ventilation air. The warmed up groundwater is injected into a second well at a temperature of about 15°C to 20°C.

When there is a demand for heating in winter, the warm groundwater is pumped up again. It is passed through the same heat exchanger in order to warm up the building water loop which subsequently warms up the ventilation air. Since the groundwater releases warmth to the building water loop, it cools down to between 4°C and 8°C. After being cooled down, the water is injected back into the first well where it is stored until the need for cooling arises in the summer. All the extracted groundwater in the system is re-injected, i.e. there is no net loss of groundwater.

There are primarily two ways of applying a groundwater cooling system to meet the cooling requirements of a building:

- direct cooling and
- a combination of direct/indirect cooling.

In the case of direct cooling (Figure 8-2), the water from the aquifer provides cooling to the building water loop which cools the air in the air-conditioning system. This system can be extended by using a chiller to supply additional cooling to the building water loop in periods of high demand (Figure 8-3).

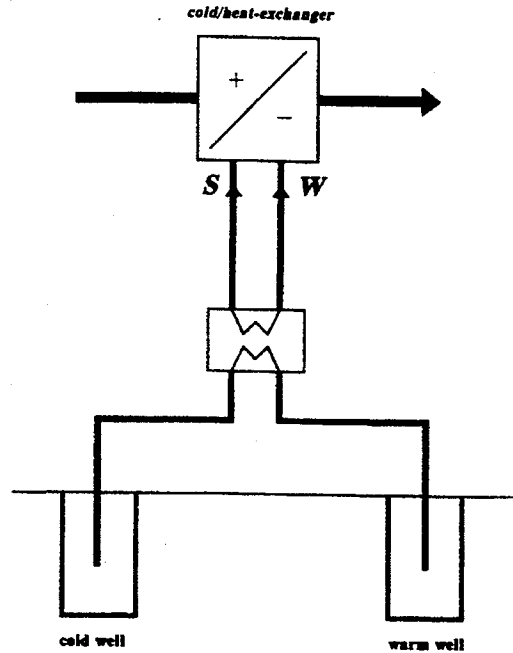

Figure 8-2: Direct ground water cooling

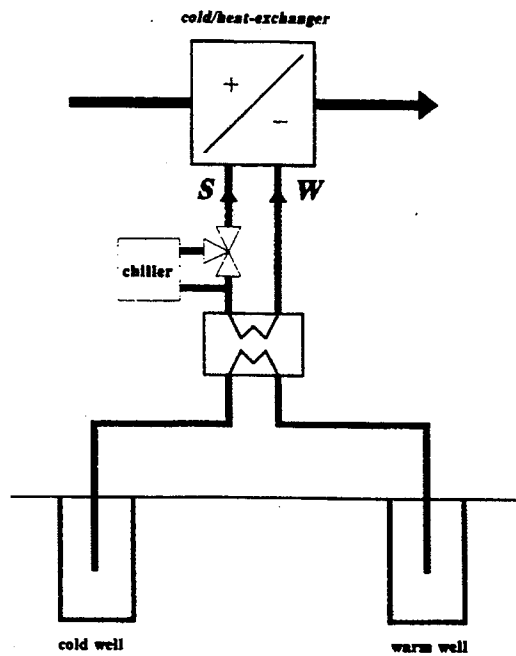

Figure 8-3: Direct ground water cooling with additional cooling

In the case of direct/indirect cooling, the building water loop is pre-cooled by the groundwater storage system (direct cooling) and a chiller supplies additional cooling to the building water loop. The groundwater is also used to cool the condenser of the chiller (indirect cooling). The advantage of this arrangement is that it reduces the condenser temperature. As a result, the size of the chiller can be reduced.

8.1 Applications

Groundwater cooling systems are suitable for both new and retrofit applications in office buildings, hospitals, shopping-centers, etc... Experience has shown that, for the time being, for a ground water cooling project to be feasible (in the Netherlands), the gross floor area should be greater than 6 000 m².

The system needs space for heat-exchangers inside the building (but normally this is not more than would be required for chillers) or for cooling towers on the roof. Outside the building, space is required for wells. A minimum of two well-pits (a cold well and a hot well) are required, each about 1.5 m by 1.5 m with a horizontal distance between them of about 100 to 150 meters.

The site must contain an aquifer of sand or some kind of limestone between 30 and 200 meters in depth, limited by tight layers of clay or a similar type of soil material. Generally, between 80-120 m³ per hour of water are extracted from each well, depending on the size of the installation.

The technology is suited to any climate where there is a cooling and a heating season. The yearly balance of the energy extracted and added to the ground water should be nearly zero.

The ground water itself provides only sensible cooling, but depending on what kind of additional cooling is connected to the system, the system may also provide some latent cooling. This technology is capable of satisfying large cooling loads.

8.2 Energy performance

The following table summarizes the energy performance of an actual direct/indirect groundwater cooling installation. The installation has four parallel wells (i.e. four cold wells and four warm wells) with a total cooling capacity of about 3500 kW and a total delivered cooling of 4650 MWh/year. Between 40 and 200 m³/hour of water are pumped from the cold wells to the warm wells. The cold wells remain between 6°C to 10°C and the warm wells between 12°C to 22°C.

The table compares the energy use of the groundwater cooling system to a conventional cooling system. The conventional system has a COP of only 4.2; the groundwater cooling system has a COP of 10.8.

Table 8-1: Energy performance of a groundwater cooling system versus a conventional cooling system - (Commerical Application)

System process	Component	Energy Use (MWh/year)	
		Conventional cooling system	Groundwater cooling system
"Free cooling" + loading cold storage	Circulation pumps	210	110
	Cooling towers	120	220
	Well pumps	---	40
Mechanical cooling	Chiller	500	20
	Cooling towers	60	---
	Circulation pumps	210	---
Unloading cold storage	Well pumps	---	40
TOTAL		1100	430

8.3 Costs

The following tables provide the capital and operating costs (not including taxes) for the groundwater cooling system and the conventional cooling system described in the previous section. This was a retrofit application in which the currently installed chillers were able to provide the small amount of mechanical cooling required for the groundwater storage system, but which would have had to have been replaced had a conventional system been installed. Table 8-4 summarizes the net capital cost, the annual savings in operating cost and the simple payback for installing a groundwater cooling system versus a conventional system.

Table 8-2a: Capital Costs (ECU)

System Component	Type of Cooling System	
	Groundwater	Conventional
<u>Installation of storage system</u>		
Well-drilling and finishing	386 455	---
Piping, electrical, etc.	170 224	---
Misc.	13 802	---
Engineering	73 610	---
Sub-total	644 091	---
<u>Building installations</u>		
Chillers	---	437 062
Cooling towers	73 610	105 815
Heat exchangers	161 023	---
Piping, pumps	128 818	193 227
Installation of controls	23 003	9 201
Engineering	50 607	96 614
Sub-total	437 062	841 919
Total cost	1 081 153	841 919
Total cost per kW	309	241

Table 8-2b: Capital Costs (US\$)

System Component	Type of Cooling System	
	Groundwater	Conventional
<u>Installation of storage system</u>		
Well-drilling and finishing	435 540	---
Piping, electrical, etc.	191 845	---
Misc.	15 555	---
Engineering	82 960	---
Sub-total	725 900	---
<u>Building installations</u>		
Chillers	---	492 575
Cooling towers	82 960	119 255
Heat exchangers	181 475	---
Piping, pumps	145 180	217 770
Installation of controls	25 925	10 370
Engineering	57 035	108 885
Sub-total	492 575	948 855
Total cost	1 218 475	948 855
Total cost per kW	348	271

Table 8-3a: Annual operating Costs (ECU)

	Type of Cooling System	
	Groundwater	Conventional
Energy	32 205	82 812
Maintenance	23 003	27 604
Groundwater tax	1 840	---
Total	57 048	110 416

Table 8-3b: Annual operating Costs (US\$)

	Type of Cooling System	
	Groundwater	Conventional
Energy	36 295	93 330
Maintenance	25 925	31 110
Groundwater tax	2 074	---
Total	64 294	124 440

Table 8-4: Savings and payback for a groundwater cooling system versus a conventional cooling system

	ECU	US\$
Capital Costs		
Groundwater cooling	1 081 153	1 218 475
Conventional cooling	841 919	948 855
Net capital cost	239 234	269 620
Annual operating Costs		
Conventional cooling	110 416	124 440
Groundwater cooling	57 048	64 294
Annual savings	53 368	60 146
Simple payback	4.5 years	

8.4 Status

In The Netherlands, Sweden and Canada, the technology is fully developed with many working installations. There are not many reasons for this kind of system not to be accepted, other than lack of knowledge of the technology and hydrogeological information. In many countries, the civil codes concerning the use of groundwater may restrict use of the technology.

The technology is most likely to first gain acceptance in office buildings, hospitals and shopping-centers with more than 6 000 m² of gross floor area. The required soil conditions can be found in river deltas or other areas found all over the world.

No special design tools are required for this technology. All the basic tools currently available regarding the transport of energy in water suffice. These tools are very user friendly and usable by installation designers for a full range of applications. The key to applying this technology is to have experience.

APPENDICES

APPENDIX A – CLIMATES

The climate has a large effect on the peak cooling demand, the total amount of cooling required throughout the cooling season and the type of cooling required (latent versus sensible). For this section, countries which contain a diversity of cooling climates were divided into zones. The following table lists the cooling zones which will be described in this section, along with their representative cities, and a brief description of the climate type. The climate descriptions are based on the cooling season parameters described later. Climates indicated as “cool” still have cooling needs especially once internal heat gains are considered.

Cooling climate zones

Country	Climate description	Representative city	Code
Canada	Warm and humid	Toronto, Ont.	C1
	Warm and very dry	Estevan, Sask.	C2
	Cool and dry	North Battleford, Sask.	C3
	Cool and semi-humid	North Bay, Ont.	C4
	Cool and humid	Vancouver, B.C.	C5
Finland	Cool and semi-humid	Helsinki	F
France	Cool and humid	Nantes	FR1
	Cool and humid	Paris	FR2
	Warm and humid	Lyon	FR3
	Warm and very humid	Nice	FR4
Germany	Warm and semi-humid	Dresden	G
Netherlands	Cool and humid	De Bilt	N
Portugal	Warm and dry	Porto	P1
	Warm and semi humid	Lisbon	P2
	Warm and humid	Faro	P3
Sweden	Cool and moderately-dry	Luleå	SWE1
	Cool and semi-humid	Stockholm	SWE2
	Cool and humid	Gothenburg	SWE3
Switzerland	Cool and semi-humid	Zürich	SWI1
United Kingdom	Cool and semi-humid	South-east England	UK
United States	Warm and semi-humid	Minneapolis, Mn.	US1
	Warm and semi-humid	New York, N.Y.	US2
	Warm and semi-humid	Washington, D.C.	US3
	Very hot and very humid	Miami, Fl.	US4
	Very hot and dry	Phoenix, Ar.	US5
	Warm and humid	Los Angeles, C.A.	US6

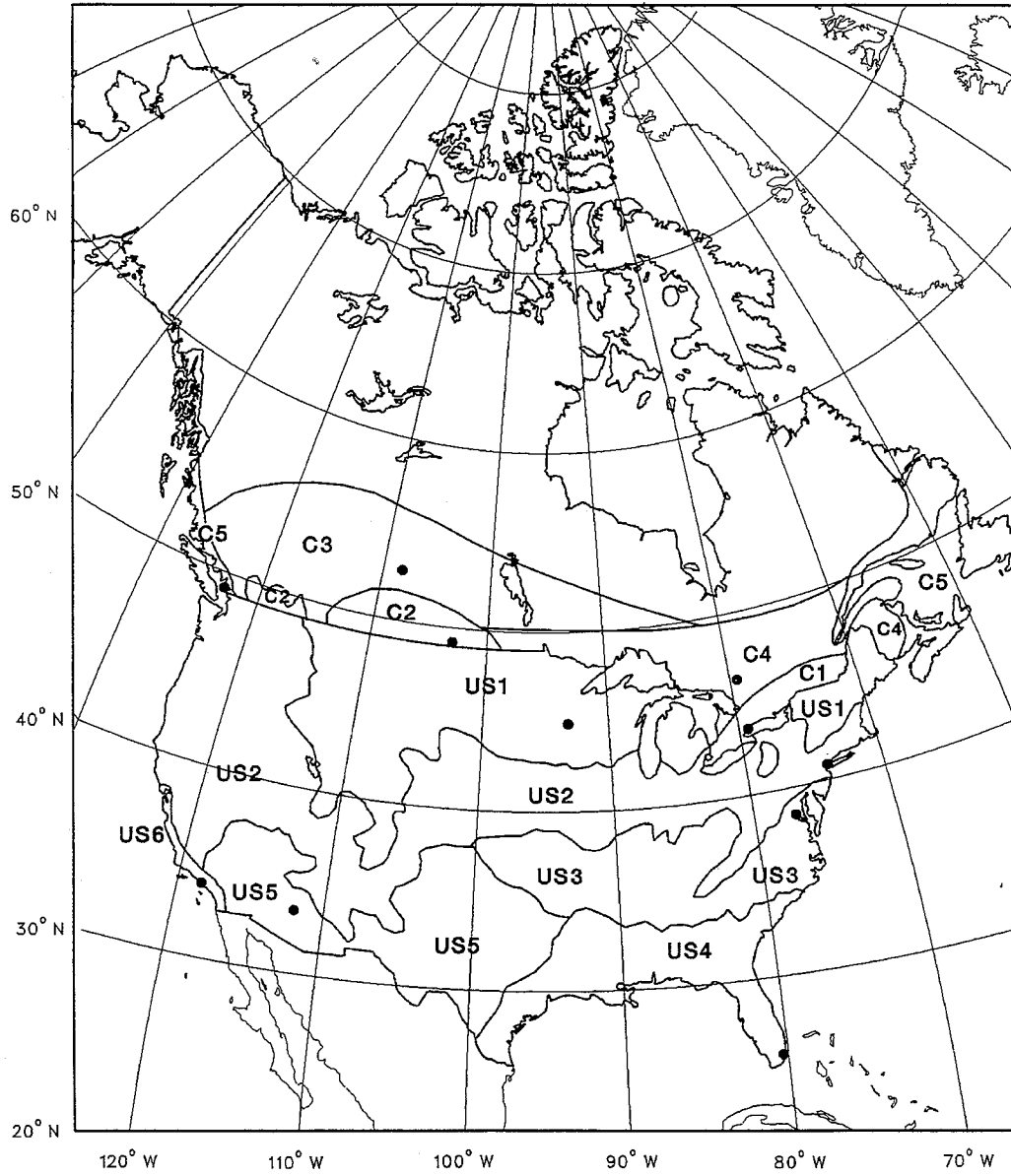

Figure A-1: North American climate zones for participating countries

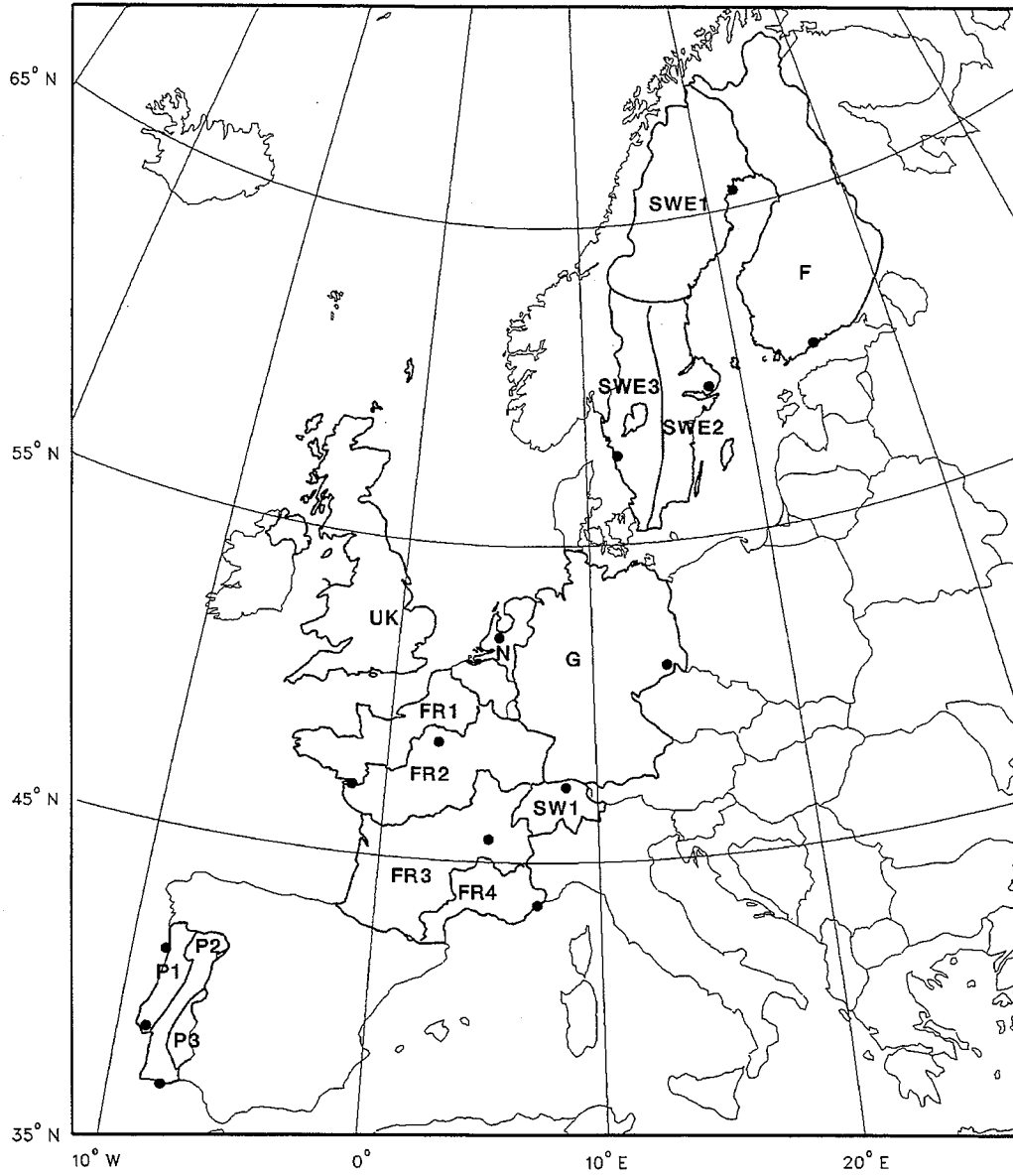

Figure A-2: European climate zones for participating countries

A1. Design temperatures

Summer design dry-bulb and wet-bulb temperatures are commonly used by HVAC designers to size the cooling equipment. The following table gives the design dry bulb and mean coincident wet bulb temperatures and the design wet bulb temperatures.

The 1% design dry bulb temperature for a location is the temperature that was equaled or exceeded for only 1% of the hours during the months of June through September in the Northern Hemisphere (a total of 2928 hours) or during the months of December through March in the Southern Hemisphere (a total of 2904 hours). The 2.5 and 5% design temperatures are defined similarly. Sometimes though the design temperatures are based only on one month of data; for example, the ASHRAE Fundamentals Handbook gives the 1%, 2.5% and 5% values for Canada, based only on the month of July (a total of 744 hours). The mean coincident wet bulb temperature is the mean of the wet bulb temperatures which occurred at the given design dry bulb temperature. The 1%, 2.5% and 5% design wet bulb temperatures are calculated in the same way as the design dry bulb temperatures.

Climate Zone	Design dry bulb / Mean Coincident Wet Bulb (°C)			Design wet bulb (°C)		
	1%	2.5%	5%	1%	2.5%	5%
	Canada - 1	32/23	31/23	30/22	25	24
Canada - 2	33/21	32/20	30/19	22	21	21
Canada - 3 ⁸	31/19	29/19	28/18	21	20	19
Canada - 4	29/20	27/19	26/19	22	21	20
Canada - 5	26/19	25/19	23/18	20	19	19
Finland	25/17	23/14	22/15	18	16	16
France - 1	30/N.A.	28/N.A.	27/N.A.	21	21	19
France - 2	32/N.A.	30/N.A.	28/N.A.	21	20	19
France - 3	33/N.A.	32/N.A.	30/N.A.	22	22	21
France - 4	31/N.A.	29/N.A.	28/N.A.	23	22	22
Germany	30/18	28/19	27/18	20	19	19
Netherlands	27/19	25/19	23/18	21	20	19
Portugal - 1	30/20	28/19	26/18	21	20	19
Portugal - 2	33/21	32/21	30/20	23	22	21
Portugal - 3	36/21	34/21	32/20	23	22	21
Sweden - 1	25/16	24/15	22/15	17	16	15
Sweden - 2	26/17	23/16	22/15	18	17	16
Sweden - 3	25.5/17	23/16	22/15	18	17	16
Switzerland	30/21	29/20	28/19	21	20	20
United Kingdom	25/N.A.	24/N.A.	23/N.A.	20	19	18
United States - 1	33/24	32/23	30/22	25	24	23
United States - 2	33/23	32/23	31/22	24	24	23
United States - 3	34/24	33/23	32/23	26	25	24
United States - 4	33/25	32/25	32/25	26	26	26
United States - 5	43/22	42/22	41/22	24	24	24
United States - 6	34/21	32/21	30/21	22	22	21

⁸ The data is related to Edmonton, Alberta site rather than North Battleford which is the representative city.

A2. Mean daily temperature range and average yearly air temperature

Some cooling technologies rely on a large difference between night-time and day-time temperatures during the cooling season. A rough measure of the diurnal temperature swing is the **mean daily temperature range**. The mean daily temperature range is defined as the difference between the average daily maximum and average daily minimum in the warmest summer month.

Some cooling technologies use the ground as the cooling source. The average yearly air temperature is a fairly accurate measure of the ground temperature for a location.

Climate zone	Mean daily temperature range (°C)	Average yearly air temperature (°C)
Canada - 1	11	7
Canada - 2	14	4
Canada - 3	13	2
Canada - 4	11	4
Canada - 5	9	10
Finland	7	4
France - 1	13	11
France - 2	12	9
France - 3	8	11
France - 4	12	15
Germany	12	9
Netherlands	12	9
Portugal - 1	10	12
Portugal - 2	13	16
Portugal - 3	15	16
Sweden - 1	9	2
Sweden - 2	8	7
Sweden - 3	7	8
Switzerland	9	9
United Kingdom	7	11
United States - 1	12	7
United States - 2	8	12
United States - 3	9	14
United States - 4	6	24
United States - 5	14	22
United States - 6	6	16

A3. Cooling degree hours and enthalpy hours

Since some cooling technologies are more suited for handling sensible cooling loads and others are better for latent loads, it is important to separate these two when examining the climate type. Although cooling degree days are often used to represent the total cooling load over the whole cooling season, they in fact only represent the sensible portion of the cooling load.

For the purposes of this annex, we have defined another term to account for the humidity in the air (i.e. **enthalpy hours** or EH) and we will be using the following definition for the **cooling degree hours** or CDH. Each of these terms has been calculated twice using two different reference points. The equations for these terms are as follows:

$$\begin{aligned} \text{CDH}_{25} &= \sum [T_i - 25]_{\text{pos}} \\ \text{CDH}_{18} &= \sum [T_i - 18]_{\text{pos}} \\ \text{EH}_{25/40} &= \sum [h_i - h_{25/40}]_{\text{pos}} \\ \text{EH}_{18/40} &= \sum [h_i - h_{18/40}]_{\text{pos}} \end{aligned}$$

where:

- Σ : the summation is for hour i from 1 to 8760 and only for positive temperature/enthalpy differences
- h_i : the average enthalpy for the i th hour (kJ/(kg · °C))
- $h_{25/40}$: the enthalpy of air at 25°C, 40% relative humidity and atmospheric pressure (kJ/(kg · °C))
- $h_{18/40}$: the enthalpy of air at 18°C, 40% relative humidity and atmospheric pressure (kJ/(kg · °C))
- T_i : the average dry-bulb temperature for the i th hour (°C)

Cooling degree hours and enthalpy hours

Country	CDH ₂₅ (°C)	EH _{25/40} (kJ/(kg · °C))	CDH ₁₈ (°C)	EH _{18/40} (kJ/(kg · °C))
Canada - 1	837	12 294	7 643	40 831
Canada - 2	1 370	5 148	7 753	27 010
Canada - 3	383	2 792	4 502	20 162
Canada - 4	128	7 399	3 720	31 519
Canada - 5	3	690	1 677	21 002
Finland	26	368	1 524	14 490
France - 1	92	2 198	3 154	27 159
France - 2	234	3091	3447	26146
France - 3	852	5778	7335	36042
France - 4	348	19131	11583	68555
Germany	527	3 040	5 154	28 068
Netherlands	N.A.	N.A.	N.A.	N.A.
Portugal - 1	648	N.A.	5880	N.A.
Portugal - 2	1 824	11 686	11 064	67 077
Portugal - 3	3 552	N.A.	15 576	N.A.
Sweden - 1	50	400	560	7 600
Sweden - 2	150	1 350	1 000	16 425
Sweden - 3	200	1 900	1 360	21 000
Switzerland	426	1 658	4 757	16 380
United Kingdom	N.A.	N.A.	N.A.	N.A.
United States - 1	2 540	21 341	13 106	56 359
United States - 2	2 570	25 698	15 942	68 783
United States - 3	4 238	42 946	22 122	93 286
United States - 4	11 896	144 969	59 420	254 614
United States - 5	27 256	39 738	59 910	96 329
United States - 6	574	8 667	7 552	64 019

A4. Solar Radiation

Design hourly solar radiation on a horizontal surface (kWh/m²/hr)
(i.e. solar radiation coincident with the design dry-bulb temperatures)

Country	1%	2.5%	5%
Canada - 1	0.57	0.48	0.47
Canada - 2	N.A.	N.A.	N.A.
Canada - 3	0.56	0.52	0.51
Canada - 4	N.A.	N.A.	N.A.
Canada - 5	0.49	0.47	0.46
Finland	0.56	0.75	0.53
France	0.48	0.49	0.49
Germany	0.58	0.55	0.53
Netherlands	N.A.	N.A.	N.A.
Portugal	0.44	0.47	0.50
Sweden - 1	0.49	0.45	0.43
Sweden - 2	0.56	0.55	0.51
Sweden - 3	0.53	0.52	0.50
Switzerland	0.53	0.50	0.50
United Kingdom	N.A.	0.61	N.A.
United States - 1	0.69	0.69	0.64
United States - 2	0.65	0.59	0.53
United States - 3	0.63	0.62	0.58
United States - 4	0.78	0.75	0.72
United States - 5	0.70	0.65	0.64
United States - 6	0.67	0.70	0.74

Annual solar radiation

Country	Solar radiation for the year (MWh/m ² /yr)	
	Horizontal	South-facing
Canada	1.3	1.0
Finland	0.9	0.8
France	1.0 - 1.5	0.8 - 1.1
Germany	1.0	N.A.
Netherlands	1.0	0.8
Portugal	1.7	1.3
Sweden	0.9 - 1.0	0.9
Switzerland	1.1	0.9
United Kingdom	0.9	0.7
United States	1.3 - 2.2	1.1 - 1.5

Average daily solar radiation

The following figures show the average daily solar radiation for each month for horizontal, North, South, East and West facing surfaces for each climate zone. For some countries there is minimal difference between their multiple cooling climate zones in terms of solar radiation so only the data for one zone are shown. For Canada zone 1 is shown; for France, zone 3 is shown and; for Portugal, zone 2. For Sweden, only zones 1 and 2 are shown; zone 3 is similar to zone 2.

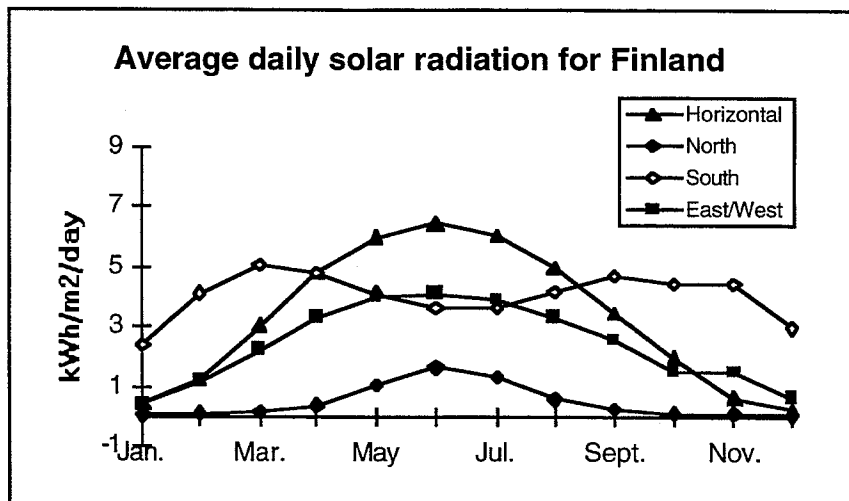
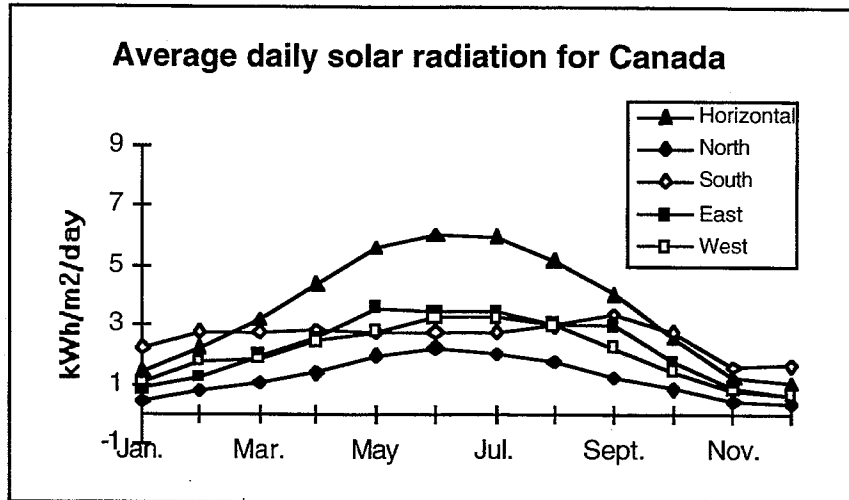

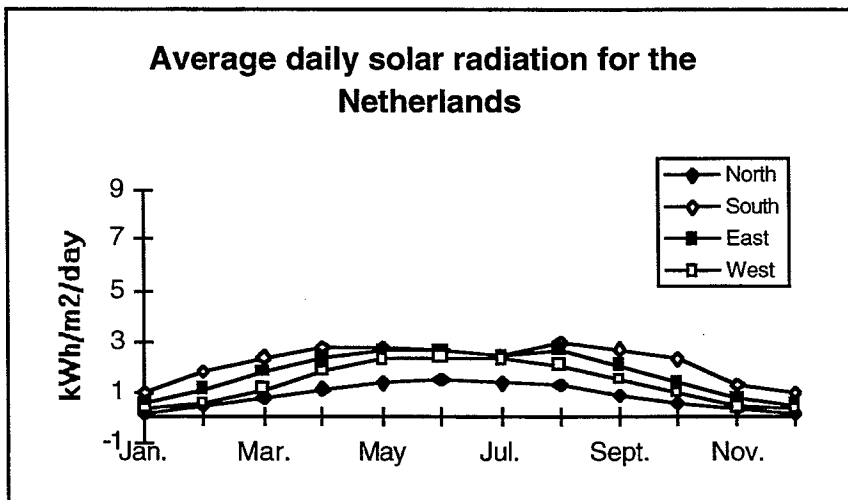
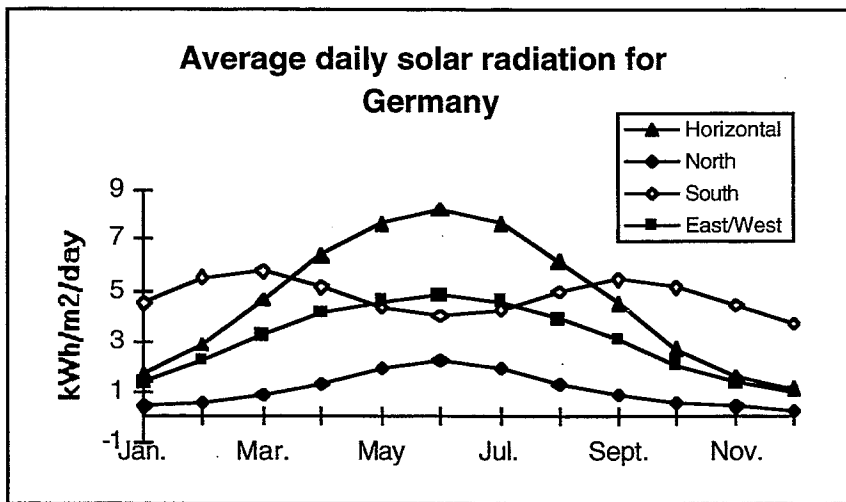
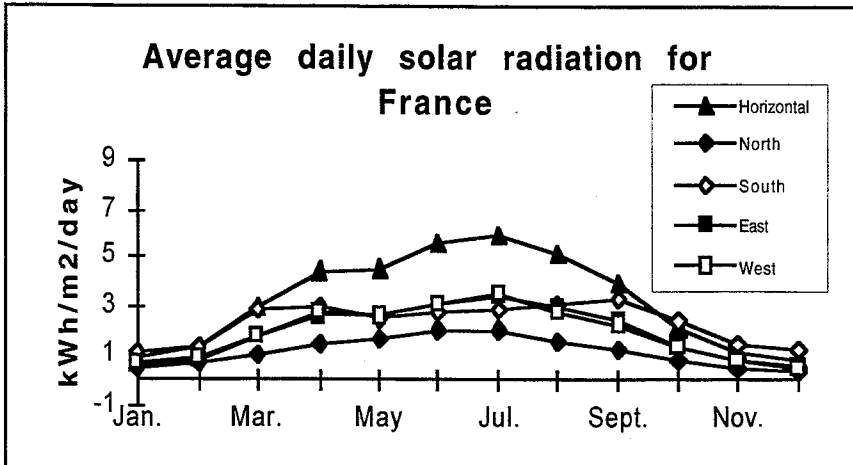

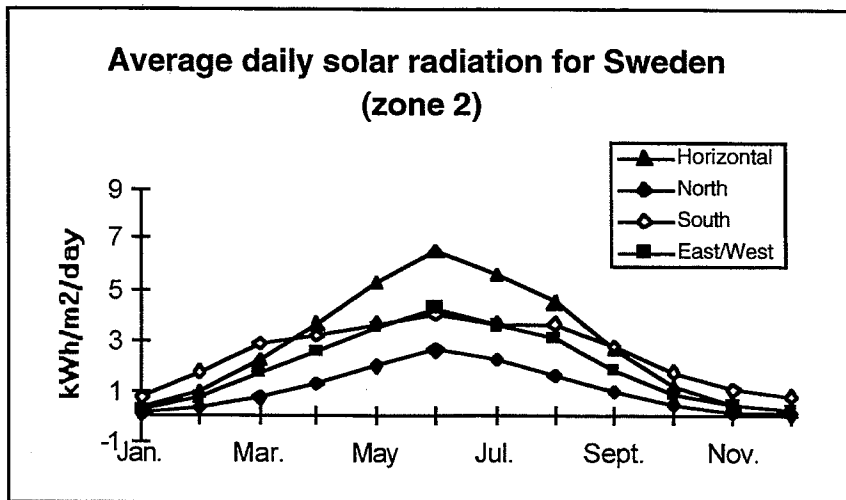
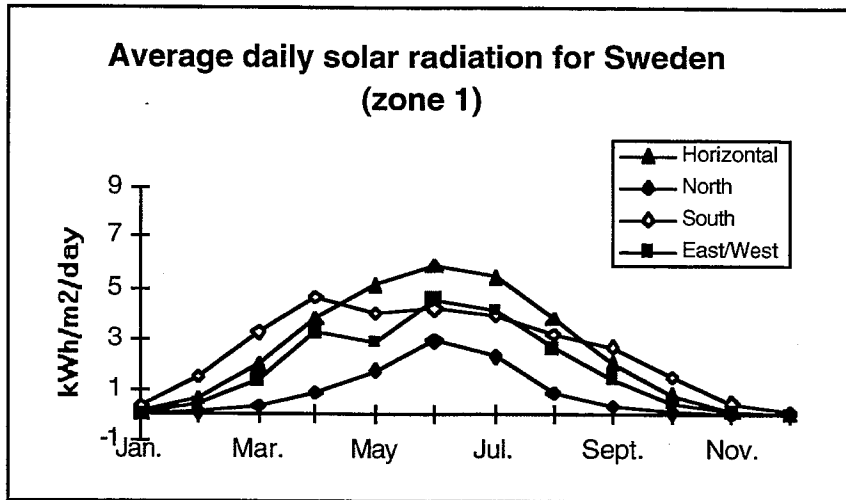
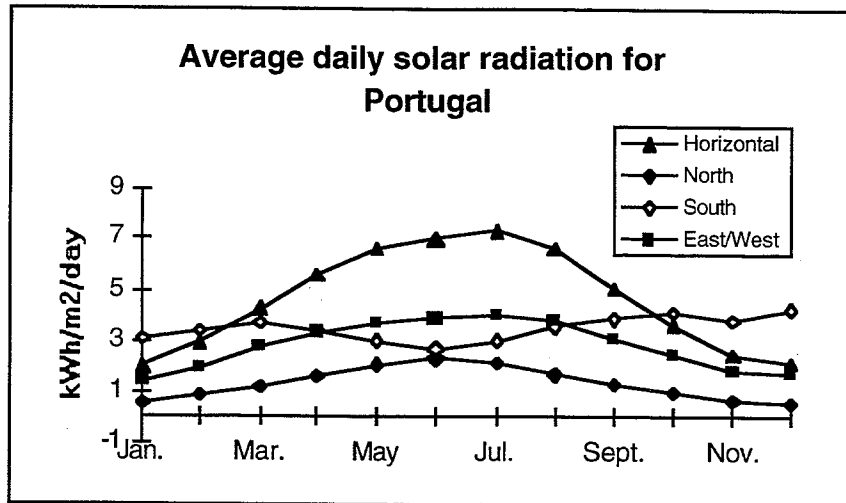

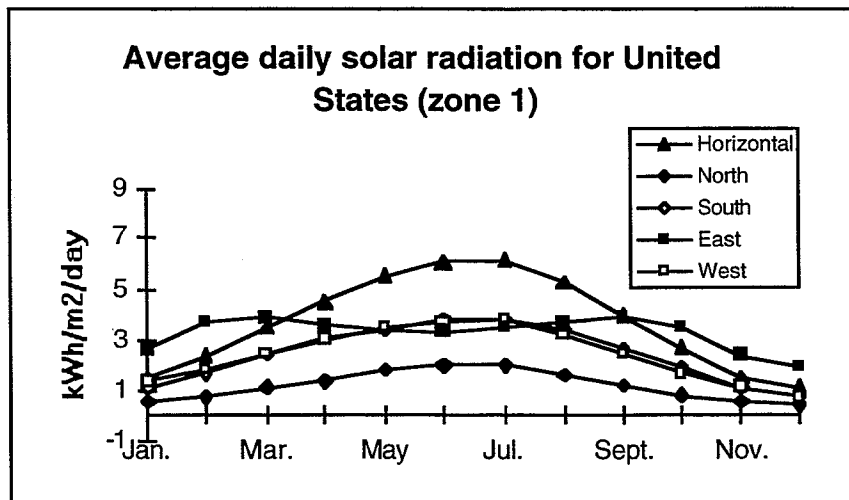
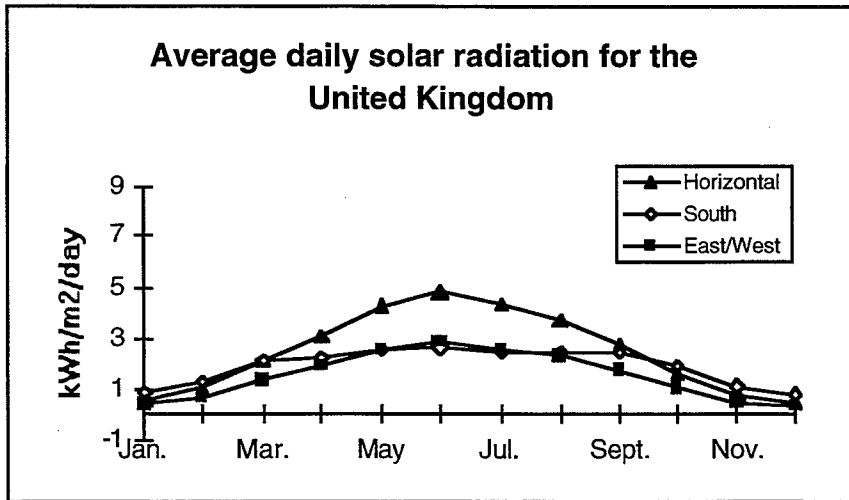
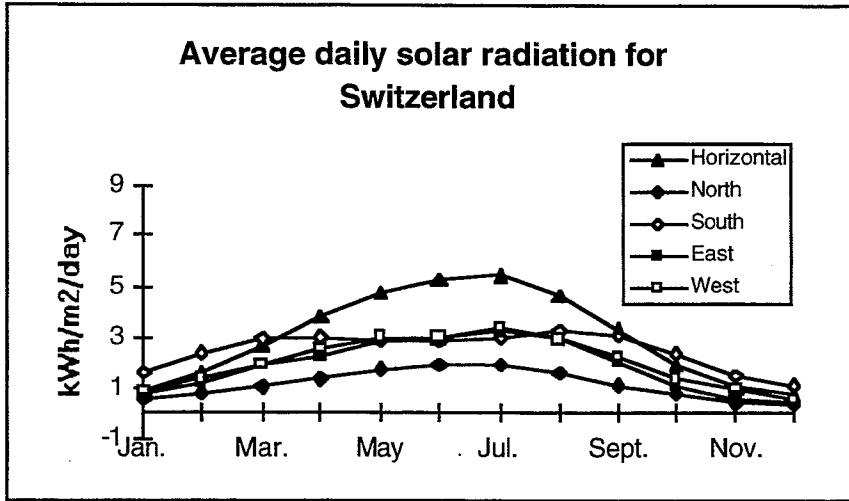

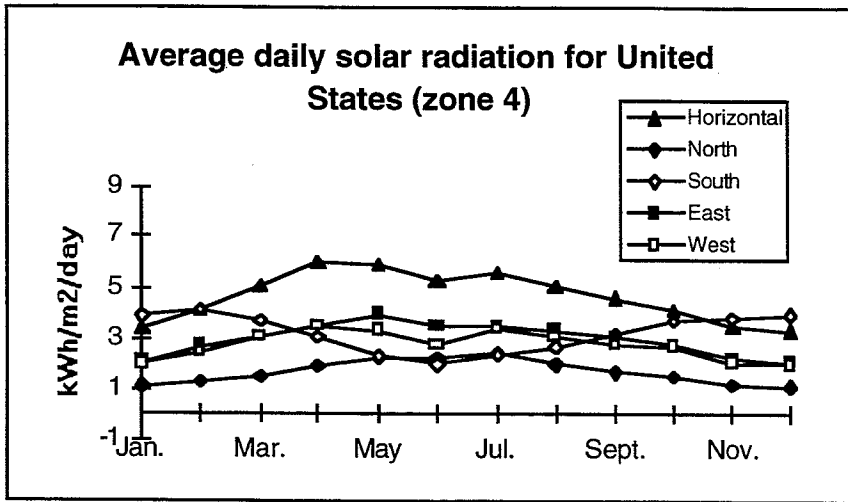
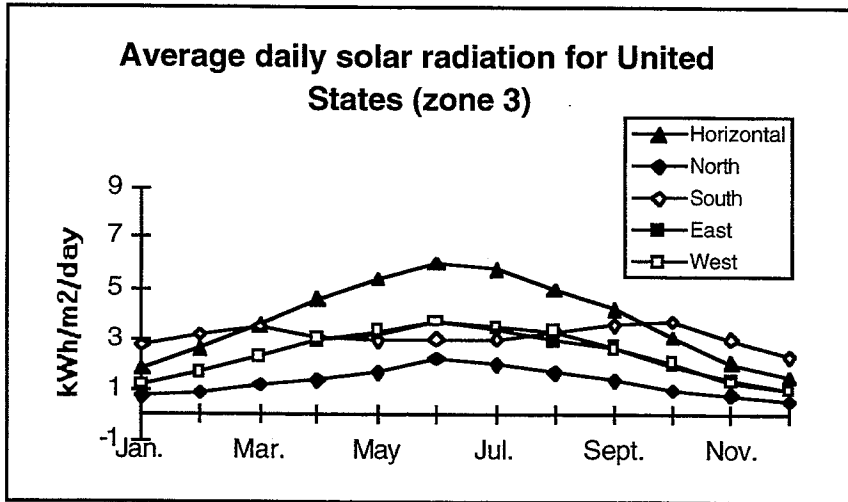
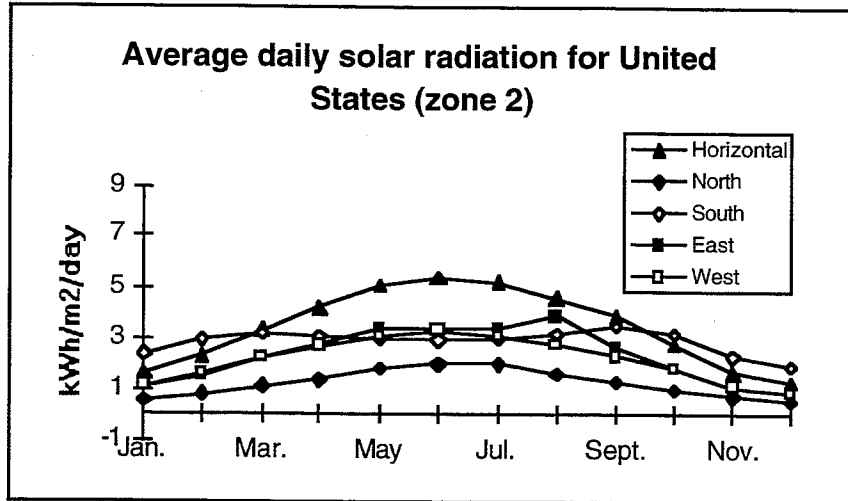

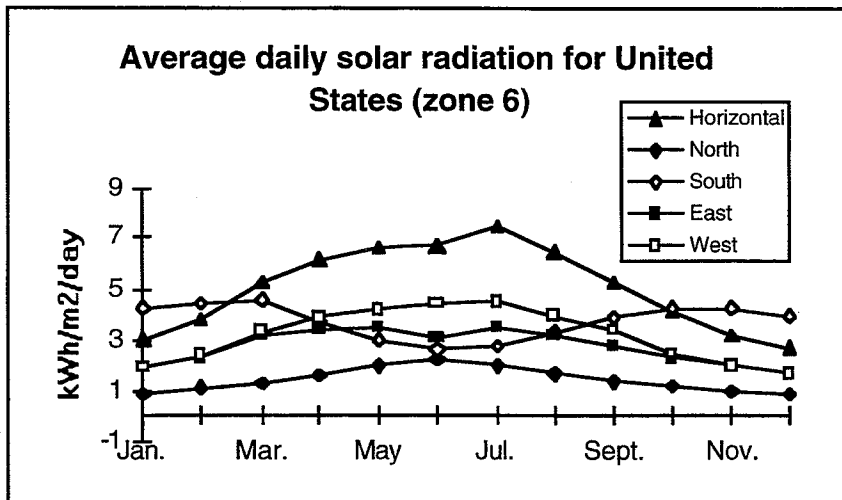
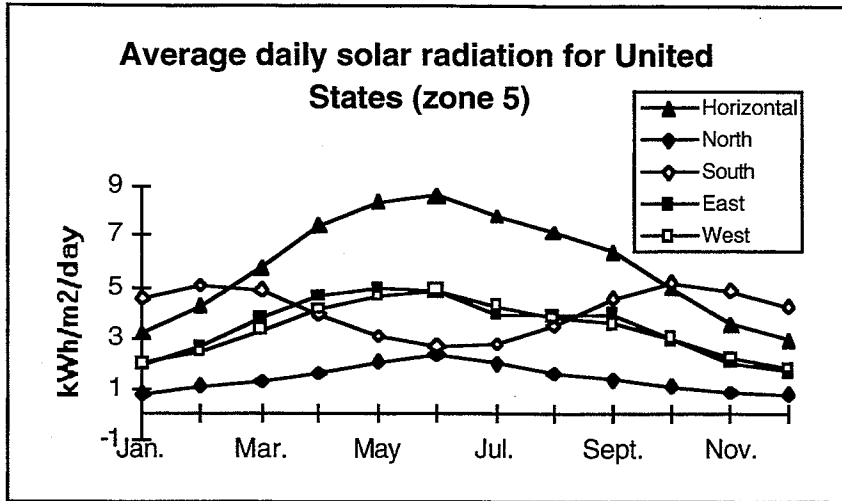

APPENDIX B – BUILDING STANDARDS AND PRACTICES

The following section documents some of the building standards and practices that affect the size of the cooling load in a building for each country participating in this annex. The following areas are addressed: the requirements for thermal comfort and ventilation rates, the insulating values for building envelopes, the amount and type of window glazing, air leakage rates, and the amount of internal heat gains in buildings.

B1. Thermal comfort

Typically referenced standards and guidelines for thermal comfort

Country	Standards and guidelines	Values for cooling season thermal comfort		
		Dry bulb temp. (°C)	Humidity	Air speed (m/s)
Canada	ASHRAE 55-92 (described below)	≈ 22 - 27	d.p. ≥ 2°C; RH ≤ 60%	< 0.25
Finland	National Building Code	≤ 27 (usually ≤ 25)	RH 50%	0.25
France	ISO 7730, ASHRAE 55-92	≈ 22 - 27	d.p. ≥ 2°C; RH ≤ 60%	< 0.25
Germany	DIN 1946, Part 2 1994	≤ 26 ⁹	RH ≤ 50%	varies
Netherlands	Fanger's PMV ≤ 0.5 ¹⁰	22 to 28	N.A.	0.15
Portugal	Portuguese regulations for HVAC Systems	25	RH = 50%	N.A.
Sweden	R1 by SCANVAC ¹¹	23.5 - 25.5 or 23 - 26 or 22 - 27	N.A.	≤ 0.20 or ≤ 0.25 or ≤ 0.40
Switzerland	SIA-Standard V382/1	22 to 28 ¹²	N.A.	0.15
United Kingdom	CIBSE ISO 7730	20 to 22 ¹³ 24.0 ± 2.2 ^{13a}	RH ≈ 50%	≤ 0.10
United States	ASHRAE 55-92	≈ 22 - 27	d.p. ≥ 2°C; RH ≤ 60%	< 0.25

⁹ When the outdoor temperature is above 29°C, the indoor temperature can be 1/3°C higher for every degree above 29°C.

¹⁰ Assumes clothing insulation value of 0.7.

¹¹ Varies with the building class.

¹² The difference between the air temperature and the mean surface temperature must be less than 4 K.

¹³ Assumes continuous occupation. For transient occupation, the maximum temperature allowed is 23°C.

^{13a} Assuming typical UK conditions and 10% PPD.

The following countries also have standards for when thermal comfort conditions are considered totally unacceptable.

Country	Unacceptable conditions
Finland	$t > 32^{\circ}\text{C}$: workers given a half hour break after every 2 hours of work
Germany	$> 10\%$ of the hours each day exceeds the previous limits
Netherlands	PMV > 0.5 for > 70 hours for extremely light buildings or > 90 hours for light and heavy buildings (i.e. $50\text{-}100\text{ kg/m}^2$)
Portugal	N.A. (Most buildings do not overheat above 30°C .)
Sweden	$t > 27^{\circ}\text{C}$ for more than 1 to 2 hrs/day
Switzerland	the sum of the Celsius-hours $> 28^{\circ}\text{C}$ exceeds $30^{\circ}\text{C}\text{-h/year}$ during office hours (not including days when the outdoor temp. $> 30^{\circ}\text{C}$)
United States	comfort zone exceeded by 3°C or more for more than 1 week/year

B1.1 ASHRAE Standard 55-92

ASHRAE Standard 55-92 actually defines the temperature in terms of an effective temperature. The **effective temperature** is the operative temperature of an enclosure at 50% relative humidity that would cause the same sensible and latent heat exchange from a person as does the actual environment. The **operative temperature** is the uniform temperature of an imaginary black enclosure in which an occupant would exchange the same amount of heat by radiation and convection as in the actual non-uniform environment. In equation form, the operative temperature (t_o) is the average of the air temperature (t_a) and mean radiant temperature (t_r), weighted by their respective heat transfer coefficients (h_c and h_r):

$$t_o = (h_c t_a + h_r t_r) / (h_c + h_r)$$

The dry bulb air temperatures thus permitted with ASHRAE Standard 55-92 depend on a number of factors and the values given in the previous table are actually in terms of operative temperature. As per the previous equation, when the mean radiant temperature and average air temperature are approximately equal, the operative temperature is approximately equal to the air temperature. The values given in the previous table also assume the following:

- that clothing has an insulating value of 0.5 clo (1 clo = $0.155\text{ m}^2 \cdot \text{K} / \text{W}$),
- primarily sedentary activity (metabolic rate #1.2)
- that the altitude is between sea level and 3000 m and
- that conditions are fairly uniform over the body.

The operative dry bulb temperature is allowed to extend higher if the air movement is increased by 0.275 m/s for each 1°C above 26°C , up to a maximum of 28°C (0.8 m/s).

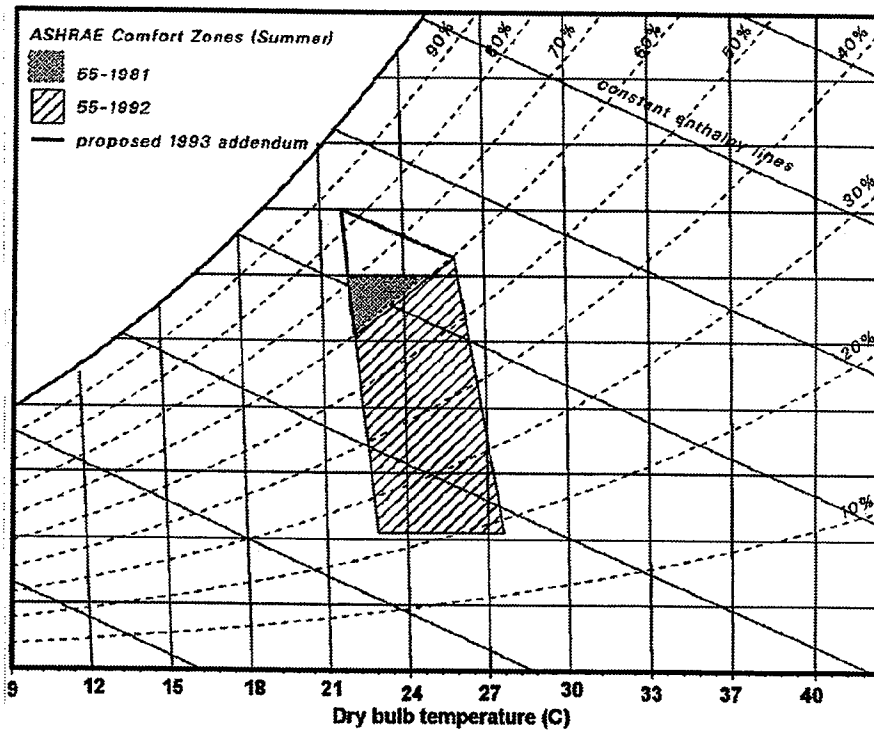

Figure B-1a: ASHRAE Standard 55 (ASHRAE psychrometric chart)

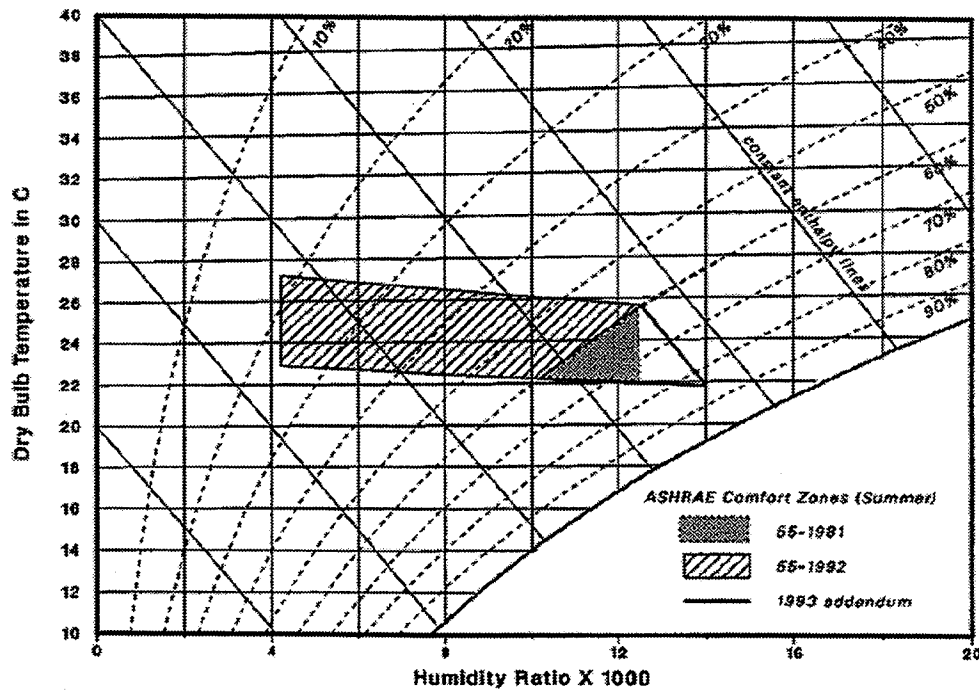

Figure B-1b: ASHRAE Standard 55 (Mollier chart)

The previous figures provide a graphical representation of the summer comfort zone for ASHRAE Standard 55. The dry bulb temperatures are in terms of the operative temperature. The minimum humidity is 4.5 g/kg, or a dew point temperature of 2°C. The effective temperature should be between 23°C to 27°C. The maximum humidity limits have changed over the years. In 1981 the maximum humidity ratio was 12 g/kg. In 1982 the maximum humidity was reduced to a relative humidity of 60%. In 1993 an addendum was proposed that extends the permitted humidity to a wet bulb temperature of 20°C.

B2. Ventilation

The following tables list the ventilation standards or guidelines typically referenced for residential and commercial buildings, the minimum outdoor air ventilation rate required and, when possible, the ventilation rates typically used. For more detail on ventilation standards and practices, refer to "Ventilation and Building Airtightness: an International Comparison of Standards, Codes of Practice and Regulations", Technical Note Number 43 (February 1994) from the Air Infiltration and Ventilation Centre.

Ventilation practices for residential buildings

Country	Standards or guidelines typically referenced	Outdoor air ventilation rate (L/s/person)	
		Minimum required	Typically used
Canada	ASHRAE 62-89, CSA F326	7.5 ¹⁴	0 - 50
Finland	National Building Code	4.0 - 10.0	N.A.
France	Arrêté du 24 mars 1982	9.0 ¹⁵	N.A.
Germany	DIN 4701	0.5 - 1.0 ACH	N.A.
Netherlands	NEN 1087	non-smoking: 4.2 - 5.6 smoking: 11	3 - 4 ACH ¹⁶
Portugal	Portuguese Regulations (similar to ASHRAE 62-89)	N.A. ¹⁷	N.A.
Sweden	Ministry of Housing by-laws and SCANVAC guidelines	bedrooms: 4.0 kitchen: 10.0	N.A.
Switzerland	SIA-Standard V 382/1: Technical standards for mechanical ventilation	3.3 - 4.2	non-smoking: 6.9 - 8.3 smoking: 8.3 - 19.4
United Kingdom	Building Regulations Approved Document, Part F	Kitchen 60 ¹⁰ Bathroom 15 ¹⁸ WC 3 ACH	0.5 to 1.0 ACH ^{18a}
United States	ASHRAE 62-89	7.5 ¹⁹	N.A.

¹⁴ Or 0.35 ACH, whichever is greater. In addition, ventilation rates for kitchen and bathrooms are as stipulated in footnote 18.

¹⁵ The standard requires two ventilation rates, a basic and a high flow rate, depending on the number of habitable rooms (e.g. 1 room requires 9.7 to 25 l/s and 5 rooms requires 29 to 58 l/s). The mean ventilation rate is about 0.5 ACH. Value given assumes 4 people in a 250 m³ house.

¹⁶ This is the total ventilation rate typically used, i.e. it includes return air as well as outdoor air.

¹⁷ Most residential buildings only have natural ventilation systems which result in 0.6 ACH as the typical mean ventilation rate when all the windows are closed. In summer, however, the windows are often opened, especially at night when temperatures are cooler.

¹⁸ Figures are per room rather than per person. All other rooms require natural ventilation openings.

^{18a} Recommended

¹⁹ Kitchens require 12 L/s/rm of continuous ventilation or 50L/s/rm of intermittent ventilation. Bathrooms require 10 L/s/rm of continuous ventilation or 25 L/s/rm of intermittent ventilation.

Ventilation practices for commercial buildings

Country	Standards and guidelines typically referenced	Outdoor air ventilation rate (L/s/person)	
		Minimum required	Typically used
Canada	ASHRAE 62-89	Office: 10	N.A.
Finland	National Building Code	Office: 4 - 10	10 - 20
France	Various	5 - 12.5 Office: 7	N.A.
Germany	DIN 1946, DIN 4701, DIN 18017, VDI 2079, VDI/VDE 3525, VDI 3803	Office: 3 - 6 ACH Conference rm: 6 - 8 ACH Restaurants: 5 - 10 ACH Schools: 5 ACH	Office: 16.7 ACH Conference rm: 6 ACH Restaurants: 11.1 ACH Schools: 8.3 ACH
Netherlands	None	N.A.	non-smoking: 4.2-5.6 smoking: 11
Portugal	Portuguese Regulations (similar to ASHRAE 62-89)	8.3 ²⁰	8.3 ²⁰
Sweden	National Swedish Board of Workers' Safety and SCANVAC guidelines	As required to reduce pollutants	N.A.
Switzerland	SIA-Standard V 382/1: Technical standards for mechanical ventilation	3.3 - 4.2	non-smoking: 6.9-8.3 smoking: 8.3 - 19.4
United Kingdom	CIBSE Guide A	Non-Smoking: 5 Some Smoking: 8 Heavy Smoking: 12	Non-Smoking: 8 Some Smoking: 16 Heavy Smoking: 24
United States	ASHRAE 62-89	Offices: 10 (higher for smoking areas, washrooms, laundromats, etc...)	N.A.

²⁰ The minimum required ventilation is 8.3 L/s/person or 1 ACH, or whichever is greater. Older buildings have only natural ventilation which may have lower ventilation rates.

B3. Building envelope characteristics

B3.1 Window glazings

Typical window glazings in residential buildings

Country	Most common glazing type	Glazing area (% of wall area)	U value (W/(m ² ·°C))	SC ²¹
Canada	Mostly double pane with or without low-e	8 - 14	1.9 - 2.8	0.67 - 0.71
Finland	Triple pane	(10 - 15% of floor area)	2.0	0.59 - 0.61
France	Double pane	25	3.6	0.10 - 0.90
Germany	Double pane	30 - 40	1.8	0.75
Netherlands ²²	N.A.	N.A.	1.5 - 2.0	0.20 - 0.30
Portugal	Single pane	(5 - 30% of floor area)	5.8	0.97 or 0.10 ²³
Sweden	Triple pane	25 - 30	2.0	0.91
Switzerland	Double pane low-e	20 - 30	1.5 - 2.0	0.75
United Kingdom	Single pane and double pane with and without coatings	25	2.0 - 5.7	0.72 - 0.95
United States	85% double pane (35% low-e), rest single and triple pane	11 - 20	1.9 - 6.3	0.79 - 1.00

²¹ For both tables in this Section B, the shading coefficient (or SC) is the solar heat gain of the fenestration system divided by the solar heat gain of double pane glass with a transmittance of 0.86, a reflectance of 0.08 and a 0.06 absorptance. In this report, unless otherwise indicated, it was assumed that there were no internal shading devices.

²² The typical glazing areas face South, when possible.

²³ The smaller number is the shading coefficient of the glazing with a shading device. Most residential buildings in Portugal have an external roller shade on the windows and most office buildings have an internal shade. These devices are partially closed during the daytime in the summer to block solar radiation.

Typical window glazings in commercial buildings

Country	Most common glazing type	Glazing area (% of wall area)	U value (W/(m ² ·°C))	SC
Canada	Double pane and may have low-e	30 - 50	1.9 - 2.8	0.67 - 0.71
Finland	Triple pane	(10 -15% of floor area)	2.0	0.59 - 0.61
France	Double pane	50	2.8	0.90
Germany	Double pane	30 - 40	≤ 1.8	0.25
Netherlands	N.A.	35	1.5 - 2.0	0.20 - 0.30
Portugal	Double pane	(5 - 30% of floor area)	4.0	0.94 or 0.5 ²⁴
Sweden	Triple pane	25 - 30 ²⁵	2.0	0.91 ²⁶
Switzerland	Double pane low-e	30 - 40	1.5 - 2.0	0.75
United Kingdom	Single pane and double pane with and without coatings	in general: 35 industrial and storage: 15	2.0 - 5.7	0.30 - 0.95
United States	50% double pane (10-20% low-e), rest: single pane	office: 30 - 50	2.3 - 6.3	0.50 - 0.80

²⁴ The smaller number is the shading coefficient of the glazing with a shading device. Most residential buildings in Portugal have an external roller shade on the windows and most office buildings have an internal shade. These devices are partially closed during the daytime in the summer to block solar radiation.

²⁵ Office buildings built before the oil crisis in 1972/73 may have glazing ratios as high as 80%.

²⁶ Often glazings on the South, East and West. are provided with fixed or movable sun louvres on the outside.

B3.2 Building envelope U-values

Typical building envelope U-values in residential buildings

Country	Typical U-values (W/(m ² ·°C))	
	Wall	Roof
Canada	0.26 - 0.47	0.17 - 0.23
Finland	0.28	0.22
France	0.40 - 0.60	0.20 - 0.30
Germany	0.50	0.30
Netherlands	0.30 - 0.40	0.30
Portugal	0.60 - 1.40	0.60 - 1.10
Sweden	0.25 - 0.30	0.17 - 0.20
Switzerland	0.25 - 0.40	0.20 - 0.30
United Kingdom	0.45 - 0.60	0.25
United States	0.34 - 0.50	0.16 - 0.20

Typical building envelope U-values in non-residential buildings

Country	Typical U-values (W/(m ² ·°C))	
	Wall	Roof
Canada	N.A.	N.A.
Finland	0.28	0.22
France	0.40 - 1.00	0.40 - 1.00
Germany	0.50	0.30
Netherlands	0.30 - 0.40	0.30
Portugal	0.60 - 1.40	0.60 - 1.10
Sweden	0.25 - 0.30	0.17 - 0.20
Switzerland	0.25 - 0.40	0.20 - 0.30
United Kingdom	0.45 - 0.60	0.45
United States	0.37 - 5.67	0.26 - 0.57

B3.3 Air leakage rates

The following tables give the typical air leakage rates for residential and commercial buildings. When these values are unknown the air tightness standard is referenced. For more detail on air tightness standards, refer to "Ventilation and Building Airtightness: an International Comparison of Standards, Codes of Practice and Regulations", Technical Note Number 43 (February 1994) from the Air Infiltration and Ventilation Centre.

Typical air leakage rates for residential buildings

Country	Air leakage rate (L/s/m ² @ 50 Pa) ²⁷	
	Low-rise	High-rise
Canada	0.50 - 1.95 (R2000: ≤ 0.50)	2.24 - 3.62
Finland	(0.10 - 0.20 L/h) ²⁸	(0.10 - 0.20 L/h) ²⁸
France	0.50 - 1.30 ²⁹	0.52 - 1.32 ²⁹
Germany	0.44 ACH	1.25 ACH
Netherlands	0.41 - 2.06 ³⁰	N.A.
Portugal	2.50	2.50
Sweden	≤ 0.83 ³¹	≤ 0.83 ³¹
Switzerland	light: 1.00 - 2.64 heavy: 0.33 - 1.32	light: 1.00 - 2.64 heavy: 0.33 - 1.32
United Kingdom	5.30	2.60
United States	0.17 - 0.23	0.17 - 0.23

²⁷ These air leakage rates are given in terms of the building envelope area for pressure differences of 50 Pa. When the air leakage rate (Q_p) was given in terms of another pressure difference (P), the following equation was used to convert the value to an air leakage rate at 50 Pa (Q_{50}):

$$Q_{50} = Q_p \times (50/P)^{0.66}$$

When the air leakage rate was given in terms of air changes per hour, unless otherwise stated, the ratio of the building volume to surface area was assumed to be 1.2 m, which is the equivalent of having a 300 m³ building with a 250 m² surface area. Thus, the equation used to convert ACH at 50 Pa (Q_{ach}) to L/s/m² at 50 Pa (Q_{Ls}) is as follows:

$$Q_{Ls} = Q_{ach} \times 0.33 \text{ L/s/m}^2/\text{ACH}$$

²⁸ This is the infiltration rate assumed for heating calculations.

²⁹ These values are based on France's air tightness standard and assume that there are exhaust mechanical ventilation systems in high-rise buildings, but none in low-rise buildings. It is assumed that mechanical ventilation systems cause 0.05 ACH, or 0.02 l/s/m², of additional air leakage.

³⁰ These values are based on the maximum recommended air leakage rates given in the Netherlands' standard for dwellings (NEN2687). In the standard, the rates are given in dm³/s and ACH at 10 Pa and depend on the size of the building (250 or 500 m³) and whether there is a mechanical ventilation system. For the 500 m³ house, the following conversion was used: 1 ACH = 0.46 L/s/m².

³¹ These values are required for buildings built since 1989. For buildings built from 1975 to 1989 the following maximum air leakage rates at 50 Pa apply:

- for single-family dwellings – 1.0 l/s/m²,
- for multi-family dwellings with less than 3 floors – 0.66 l/s/m² and,
- for multi-family dwellings with more than or equal to 3 floors – 0.33 l/s/m².

Typical air leakage rates for commercial buildings

Country	Building type	Air leakage rate (L/s/m ² @ 50 Pa) ³²
Canada	Office	1.50 - 5.00
Finland	Any	(0.10 - 0.20 l/h) ³³
France	Any	(≤ 0.20 ACH)
Germany	Any	0.85
Netherlands	With operable windows	1.80
	Without operable windows	0.50
Portugal	Any	2.50
Sweden	Any	No standards
Switzerland	Any	light: 1.00 - 2.64
		heavy: 0.33 - 1.32
United Kingdom	Any	3.90
United States	Any	0.50 - 2.00

³² These air leakage rates are given in terms of the building envelope area for pressure differences of 50 Pa. When the air leakage rate (Q_P) was given in terms of another pressure difference (P), the following equation was used to convert the value to an air leakage rate at 50 Pa (Q_{50}):

$$Q_{50} = Q_P \times (50/P)^{0.66}$$

³³ This is the infiltration rate assumed for heating calculations.

B4. Internal heat gains

The following tables indicate the peak sensible (Sens.) and latent (Lat.) internal heat gains from people, lights and appliances (Appl.) for residential and commercial buildings. It is assumed that an average of 75 W of sensible gains and 55 W latent gains arise directly from the people. In addition to the latent gains which arise directly from the people, 2.7 W/m² of latent gains are assumed to occur in residential buildings due to domestic activities like laundry and cooking.

Typical peak internal heat gains in residential buildings

Country	People (#/100m ²)	Peak internal heat gains (W/m ²)					
		People		Lights	Appl.	TOTAL	
		Lat.	Sens.	Sens.	Sens.	Lat.	Sens.
Canada	2	1.1	1.4	3.8	4.3	3.8	9.5
Finland	3	1.7	2.3	15 - 20	10 - 20	4.4	27.3 - 42.3
France	5	2.8	3.8	15	30	5.5	48.8
Germany	5	2.8	3.8	12	30	5.5	45.8
Netherlands	5	2.8	3.8	10	10 - 40	5.5	23.8 - 53.8
Portugal	5	2.8	3.8	5	5	5.5	13.8
Sweden	N.A.	N.A.	N.A.	N.A.	N.A.	N.A.	N.A.
Switzerland	2.5	1.4	1.9	4	3	4.1	8.9
United Kingdom	5	2.8	3.8	1.5	5.5	5.5	10.8
United States	2	1.1	1.5	4	5.3	3.8	10.8

In the following table for commercial buildings, since the heat gains may be quite different in the perimeter (P) versus the interior core (I) of the building, the internal heat gains are sometimes given separately for each of these areas.

Typical peak internal heat gains in commercial buildings

Country	Building type	People (#/100m ²)	Peak internal heat gains (W/m ²)					
			People		Lights	Appl.	TOTAL	
			Lat.	Sens.	Sens.	Sens.	Lat.	Sens.
Canada	Office	4	2.2	3.0	22	8	2.2	33.0
Finland	Any	13	7.2	9.8	15 - 20	10 - 20	7.2	34.8-49.8
France	Office	10	5.5	7.8	15	40	5.5	62.8
	Retail	40	15.5	27.5	60	1	15.5	88.5
Germany	Office - P	5	2.8	3.8	8	15	2.8	26.8
	Office - I	10	5.5	7.5	12	30	5.5	49.5
Netherlands	Office - P	10	5.5	7.5	10	15 - 20	5.5	32.5-37.5
	Office - I	7	3.9	5.3	15	15 - 20	3.9	35.3-40.3
Portugal	Office	10	5.5	7.5	10 - 15	15	5.5	32.5-37.5
	Retail	40	22.0	30.0	10 - 15	8	22	48.0-53.0
Sweden	Office - P	8	4.5	6.0	15	20	4.5	41.0
	Office - I	3	1.7	2.3	15	20	1.7	37.3
	Retail - P	30	18.2	22.5	25	5 - 10	18.2	52.5-57.5
	Retail - I	20	11.0	15.0	25	5 - 10	11.0	45.0-50.0
Switzerland	Office - P	8	1.7	2.3	6	3.5	1.7	11.8
	Office - I	6	1.3	1.8	10	3.5	1.3	15.3
	Retail	varies	-	-	12	2	-	> 14.0
United Kingdom	Office	10	5.5	7.5	15	15	5.5	37.5
United States	Office	3	1.7	2.3	18	13	1.7	33.3
	Retail	6.7	3.7	5.0	22.5	3.2	3.7	30.7

APPENDIX C – ENERGY SOURCES AND COSTS

The feasibility of a passive and hybrid cooling system depends on the energy sources and costs. This appendix outlines the energy sources for the electricity production in each of the countries, and the average costs for electricity and fuels. Some methods of electricity production tend to have higher peak demand charges which may increase the viability of installing a passive and hybrid cooling technology which reduces the peak demand for electricity. If the main electricity sources produce large amounts of greenhouse gases then from a global point of view it would be better to select a passive and hybrid cooling technology that reduces energy consumption.

C1. Energy sources

Country	Energy sources for electricity (%)						
	Hydro	Coal	Oil	N. Gas	Nucl.	Import	Other
Canada	62	13	5	3	16	1	0
Finland	17	15	3	7	29	17	12
France	14	9	3	1	72	0	1
Germany	4	49	2	6	38	0	1
Netherlands	0	38	2	53	5	0	2
Portugal	29	34	37	0	0	0	0
Sweden	52	0	3 ³⁴	3 ³⁴	42	0	0
Switzerland	56	0	2 ³⁴	1 ³⁴	41	0	0
United Kingdom	2	58	7	4	24	5	0
United States	9	56	3	10	22	0	0

³⁴ The exact split between oil and natural gas is unknown. The total of the electricity production from oil and natural gas is produced by combined heat and power plants (cogeneration).

C2. Energy costs

The following tables give the average costs, including taxes, for electricity and fuels. In reality most countries have a variety of electricity rates (e.g. time-of-use rates, demand charges, declining block structures), which would be impossible to fully describe in this report. The rates that apply to a specific building should be considered when considering a passive and hybrid cooling technology. Many of these technologies reduce peak demands for electricity which can result in large reductions in energy costs.

In some cases, the costs for oil were given in terms of litres as opposed to gigajoules. In these cases the following conversions were assumed:

Light oil #1, low sulfur	0.0359 GJ/L	(27.86 L/GJ)
Heavy oil #4, low sulfur	0.0383 GJ/L	(26.11 L/GJ)

Average energy costs for residential customers (ECU)

Country	N. Gas (ECU/GJ)	Light oil #1 (ECU/GJ)	Other (ECU/GJ)	Electricity (ECU/kWh)
Canada	3.21	6.80	N.A.	0.051 ³⁵
Finland	2.84	6.48	heavy oil #4 4.04	0.074
France	9.16	8.16	N.A.	0.106 ³⁶
Germany	10.12	4.34	N.A.	0.122
Netherlands	6.83	7.18	N.A.	0.101
Portugal	N.A.	N.A.	Propane gas 9.26	0.100
Sweden	N.A.	12.31	N.A.	0.067 ³⁷
Switzerland	6.50	3.90	N.A.	0.090 ³⁸
United Kingdom	5.42	4.55	N.A.	0.082
United States	5.47	4.60	N.A.	0.073 ³⁹

³⁵ In Canada, the price for electricity ranges from 0.041 to 0.075 ECU/kWh, depending on the province.

³⁶ In France, the price for electricity ranges from 0.061 to 0.152 ECU/kWh.

³⁷ In Sweden, the price for electricity ranges from 0.053 to 0.084 ECU/kWh.

³⁸ In Switzerland, the price for electricity ranges from 0.044 to 0.15 ECU/kWh.

³⁹ In the United States, the price for electricity ranges from 0.040 to 0.098 ECU/kWh.

Average energy costs for residential customers (US\$)

Country	N. Gas (US\$/GJ)	Light oil #1 (US\$/L)	Other (US\$/GJ)	Electricity (US\$/kWh)
Canada	3.62	7.69	N.A.	0.057 ⁴⁰
Finland	3.20	7.30	heavy oil #4 4.55	0.083
France	10.32	9.22	N.A.	0.120 ⁴¹
Germany	11.41	4.89	N.A.	0.138
Netherlands	7.70	8.09	N.A.	0.114
Portugal	N.A.	N.A.	Propane gas 10.44	0.110
Sweden	N.A.	13.90	N.A.	0.076 ⁴²
Switzerland	7.60	4.74	N.A.	0.100 ⁴³
United Kingdom	6.11	5.14	N.A.	0.093
United States	6.16	5.18	N.A.	0.082 ⁴⁴

⁴⁰ In Canada, the price for electricity ranges from 0.046 to 0.085 US\$/kWh, depending on the province.

⁴¹ In France, the price for electricity ranges from 0.069 to 0.171 US\$/kWh.

⁴² In Sweden, the price for electricity ranges from 0.60 to 0.095 US\$/kWh.

⁴³ In Switzerland, the price for electricity ranges from 0.05 to 0.17 US\$/kWh.

⁴⁴ In the United States, the price for electricity ranges from 0.045 to 0.111 US\$/kWh.

Average energy costs for commercial customers (ECU)

Country	N. Gas (ECU/GJ)	Other (ECU/GJ)	Electricity (ECU/kWh)
Canada	3.21	N.A.	0.042 ⁴⁵
Finland	N.A.	light oil #1 5.59 heavy oil #4 4.00	0.070 ⁴⁶
France	6.75	N.A.	0.084 ⁴⁷
Germany	7.13	N.A.	0.124 ⁴⁸
Netherlands	N.A.	N.A.	N.A.
Portugal	N.A.	Propane gas 8.86	0.100 ⁴⁹
Sweden	N.A.	N.A.	0.054 ⁵⁰
Switzerland	5.50	N.A.	0.070 ⁵¹
United Kingdom	4.80	N.A.	0.084
United States	4.57	Oil #2 3.09	0.068 ⁵²

⁴⁵ In Canada, the price for electricity ranges from 0.029 to 0.067 ECU/kWh, depending on the province.

⁴⁶ In Finland, the price for electricity depends on the time of use. The rate given above is for daytime use; whereas at night-time the rates are considerably less: 0.024 to 0.0289 ECU/kWh.

⁴⁷ In France, the price for electricity ranges from 0.030 to 0.304 ECU/kWh.

⁴⁸ In Germany, the price for electricity ranges from 0.083 to 0.459 ECU/kWh.

⁴⁹ In Portugal, the price for electricity ranges from 0.036 to 0.19 ECU/kWh.

⁵⁰ In Sweden, the price for electricity ranges from 0.035 to 0.060 ECU/kWh.

⁵¹ In Switzerland, the price for electricity ranges from 0.05 to 0.08 ECU/kWh.

⁵² In the United States the price for electricity ranges from 0.038 to 0.099 ECU/kWh.

Average energy costs for commercial customers (US\$)

Country	N. Gas (US\$/GJ)	Other (US\$/GJ)	Electricity (US\$/kWh)
Canada	3.62	N.A.	0.048 ⁵³
Finland	N.A.	light oil #1 6.30 heavy oil #4 4.50	0.079 ⁵⁴
France	7.60	N.A.	0.094 ⁵⁵
Germany	8.03	N.A.	0.140 ⁵⁶
Netherlands	N.A.	N.A.	N.A.
Portugal	N.A.	Propane gas 9.99	0.110 ⁵⁷
Sweden	N.A.	N.A.	0.061 ⁵⁸
Switzerland	6.60	N.A.	0.080 ⁵⁹
United Kingdom	5.40	N.A.	0.095
United States	5.15	Oil #2 3.48	0.077 ⁶⁰

⁵³ In Canada, the price for electricity ranges from 0.033 to 0.076 US\$/kWh, depending on the province.

⁵⁴ In Finland, the price for electricity depends on the time of use. The rate given above is for daytime use; whereas at night-time the rates are considerably less: 0.027 to 0.032 US\$/kWh.

⁵⁵ In France, the price for electricity ranges from 0.0343 to 0.3426 US\$/kWh.

⁵⁶ In Germany, the price for electricity ranges from 0.094 to 0.517 ECU/kWh.

⁵⁷ In Portugal, the price for electricity ranges from 0.042 to 0.22 US\$/kWh.

⁵⁸ In Sweden, the price for electricity ranges from 0.040 to 0.067 US\$/kWh.

⁵⁹ In Switzerland, the price for electricity ranges from 0.06 to 0.10 US\$/kWh.

⁶⁰ In the United States the price for electricity ranges from 0.043 to 0.112 US\$/kWh.

APPENDIX D - WATER COSTS

The following tables provide typical water costs which can be useful in determining the cost-effectiveness of those technologies requiring the use of water for cooling. The tables reflect the various cost formats as it is not possible to converge to the same basis.

D1. Costs (ECU)

Country	Residential (ECU/m ³)	Commercial (ECU/m ³)
Canada	0.28 - 0.93 (assuming 25 m ³ /month) (supply and sewerage)	0.16 - 0.61 (assuming 100 m ³ /month) (supply and sewerage)
Finland	1.82 - 2.13 (supply and sewerage)	1.82 - 2.13 (supply and sewerage)
France	1.50 - 2.00 (supply and sewerage)	1.50 - 2.00 (supply and sewerage)
Germany	N.A.	N.A.
Netherlands	N.A.	N.A.
Portugal	N.A.	N.A.
Sweden	N.A.	N.A.
Switzerland	0.62 supply 0.92 sewerage	0.62 supply 0.92 sewerage
United Kingdom	0.62 - 0.97 supply (29.08 - 47.58 ECU/yr standard charge) 0.47 - 1.95 sewerage (0.00 - 67.61 ECU/yr standard charge)	Volumetric charges similar to residential. Standing charges vary with connection diameter.
United States	0.66 (supply and sewerage) (for typical use of 46.18 m ³ /month)	0.97 (supply and sewerage) (for 1,840 m ² building using 58 m ³ /month)

D2. Costs (US\$)

Country	Residential (US\$/m ³)	Commercial (US\$/m ³)
Canada	0.32 - 1.05 (assuming 25 m ³ /month) (supply and sewerage)	0.18 - 0.69 (assuming 100 m ³ /month) (supply and sewerage)
Finland	2.05 - 2.40 (supply and sewerage)	2.05 - 2.40 (supply and sewerage)
France	1.69 - 2.25 (supply and sewerage)	1.69 - 2.25 (supply and sewerage)
Germany	N.A.	N.A.
Netherlands	N.A.	N.A.
Portugal	N.A.	N.A.
Sweden	N.A.	N.A.
Switzerland	0.70 supply 1.04 sewerage	0.70 supply 1.04 sewerage
United Kingdom	0.70 - 1.09 supply (32.75 - 53.58 US\$/yr standard charge) 0.53 - 2.20 sewerage (0.00 - 76.14 US\$/yr standard charge)	Volumetric charges similar to residential. Standing charges vary with connection diameter.
United States	0.74 (supply and sewerage) (for typical use of 46.18 m ³ /month)	1.09 (supply and sewerage) (for 1,840 m ² building using 58 m ³ /month)

APPENDIX E – EXCHANGE RATES

The following exchange rates were used when calculating costs throughout this report. Costs were initially given in the currency for the author's country and then converted to ECU and US\$ using the rates which were based on mid-market rates in Toronto, Canada, as of noon March 4, 1994. For example, 1 Dutch Guilder equals 0.4601 ECU or 0.5185 US\$.

Exchange rates

To convert from:	To ECU	To US \$
Canadian Dollar (\$)	0.6537	0.7368
Finnish Mark (FIM)	0.1598	0.1801
French Franc (FF)	0.1520	0.1713
German Mark (DM)	0.5165	0.5821
Dutch Guilder	0.4601	0.5185
Portuguese Escudo (PTE)	0.0051	0.0057
Swedish Krona (SEK)	0.1106	0.1247
Swiss Franc (SFr)	0.6162	0.6945
British Pound	1.3217	1.4895
United States' Dollar (US\$)	0.8873	1.0000

APPENDIX F – TECHNOLOGY AND NATIONAL DATA AUTHORS

For a copy of a particular "Technology Overview" report, please contact the author directly.

<u>Technology</u>	<u>Author's address</u>	<u>Phone numbers</u>
Chilled ceilings & displacement ventilation	Bertholde Mengede Universitat Essen Universitats Str. 15 45 141 Essen Germany	Ph: +49 201 183 2623 Fax: +49 201 183 2584
	K.D. Laabs Stulz GmbH Holsteiner Chausee 283 22 457 Hamburg Germany	Ph: +49 40 558 5416 Fax: +49 40 559 4458
Desiccant cooling	Dr. Sophie Hosatte Heat Management Technologies EDRL/CANMET 1615 Montée Ste-Julie, C.P. 4800 Varenes, Québec Canada J3X 1S6	Ph: +1 514 652-5331 Fax: +1 514 652 5177
Evaporative cooling	Mr. Joe Huang Lawrence Berkeley Laboratory Mailstop 90-4000 1 Cyclotron Road Berkeley, California 94720 United States	Ph: +1 510 486 7082 Fax: +1 510 486 6996
Ground cooling with air	Mr. Mark Zimmermann EMPA - KWH Ueberlandstrasse 129 CH-8600 Duebendorf Switzerland	Ph: +41 1 823 4178 Fax: +41 1 821 6244
Night cooling - Commercial	Dr. Maria Kolokotroni Building Research Establishment Bucknalls Lane Garston, Watford WD2 7JR United Kingdom	Ph: +44 1 923 894040 Fax: +44 1 923 664095

Night cooling - Residential	Mr. Jean-Robert Millet Centre Scientifique et Technique du Bâtiment 84 Avenue Jean Jaurès BP 02 77421 Marne-la-Vallée Cedex 2 France	Ph: +33 1 64 68 83 23 Fax: +33 1 64 68 83 50
Slab cooling with air	Mr. Risto Kosonen Technical Research Centre of Finland Building Technology PO Box 1804 Lämpömiehenkuja 3 FIN-02044 VTT Finland	Ph: +358 0 456 6147 Fax: +358 0 455 2408
Slab cooling with water	Mr. Christian Feldmann COSTIC Domaine de Saint-Paul F-78470 St Remy lés Chevreuse France	Ph: +33 1 3085 2021 Fax: +33 1 3085 2038
	Mr. Eric Michel COSTIC - Digne Rue A. Lavoisier Z.I. de St-Christophe 04000 Digne	Ph: 33 1 16 9231 1930 Fax: 33 1 16 9232 4571
	Professor Eduardo Maldonado or Mr. J.L. Alexandre DEMEGI Faculdade Engenharia Universidade do Porto Rua dos Bragas 4099 Porto Cedex	Ph: +351 2 200 7455 Fax: +351 2 312 476
Ground cooling with Water using Aquifers	Mr. Hendrik C Roel Coman Raadgevende Ingenieurs BV PO Box 140 NL 3730 AC De Bilt	Ph: +31 30 211 784 Fax: +31 30 210 372

For a copy of a particular country's "National Data" report, please contact the author directly.

<u>Country</u>	<u>Author's address</u>	<u>Phone numbers</u>
Canada	Ms. Kathleen Fraser Fraser & Associates 145 Holland St. N.W., Suite 200 Calgary, Alberta T2K 2E8	Ph: 1 403 284-3309 Fax: 1 403 284-3310

Finland	Mr. Risto Kosonen Technical Research Centre of Finland Building Technology PO Box 1804 Lämpömiehenkuja 3 FIN-02044 VTT	Ph: +358 0 456 6147 Fax: +358 0 455 2408
France	Mr. Dominique Marchio École des Mines de Paris Centre d'Energétique 60 Boulevard Saint-Michel 75006 Paris	Ph: +33 1 4051 9180 Fax: +33 1 4634 2491
Germany	Dr Ing Uwe Franzke Institut für Luft und Kältetechnik GmbH Bertolt-Brecht-Allee 20 01309 Dresden	Ph: +49 351 4081 650 Fax: +49 351 4081 655
The Netherlands	Mr. Hendrik C Roel Coman Raadgevende Ingenieurs BV PO Box 140 NL 3730 AC De Bilt	Ph: +31 30 211 784 Fax: +31 30 210 372
Portugal	Professor Eduardo Maldonado DEMEGI Faculdade Engenharia Universidade do Porto Rua dos Bragas 4099 Porto Cedex	Ph: +351 2 200 7455 Fax: +351 2 312 476
Sweden	Mr. Johnny V Andersson Scandiaconsult Kapellgränd 7 Box 4205 10265 Stockholm	Ph: +46 8 615 6215 Fax: +46 8 702 1935
Switzerland	Mr. Mark Zimmermann EMPA - KWH Ueberlandstrasse 129 CH-8600 Duebendorf	Ph: +41 1 823 4178 Fax: +41 1 821 6244
United Kingdom	Dr. Maria Kolokotroni Building Research Establishment Bucknalls Lane Garston, Watford WD2 7JR	Ph: +44 1 923 894040 Fax: +44 1 923 664095
United States	Mr. Joe Huang Lawrence Berkeley Laboratory Mailstop 90-4000 1 Cyclotron Road Berkeley, California 94720	Ph: 1 510 486 7082 Fax: 1 510 486 6996

APPENDIX G - ADDITIONAL REFERENCES

In addition to the previous references in the technologies' sections, the following are additional material that can benefit readers in furthering their understanding of the various technologies.

Night Ventilation

Lane-Serff, G.F., Linden, P.F. and Smeed, D.A., Laboratory and mathematical models of natural ventilation

Van der Maas, J. and Roulet, C.A., "A simple model for the estimation of potential cooling by nighttime ventilation", *Architecture and Urban Space*, pp. 521-530, Kluwer Academic Publishers, Netherlands (1991).

Ground cooling with air

Baumgartner, Th., Erdwärmennutzung für die Raumklimatisierung, NEFF-Research-Report 390 (1995).

Baumgartner, Th. et al, *Architektur und Energiekonzept*, SI+A Nr. 49 (December 1993).

Maerki, H., Making the most of a design opportunity, *CADDET Newsletter*, No. 4 (1991).

Meierhans, R. and Zimmermann, M., *Innovative Cooling Systems*, FBF Workshop Report (June 1992).

Slab cooling with air

Korhonen, P., Laine, J., Muro, O., and Virtanen, M., EBES — integrated HEVAC, piping, electrical and building system, Research Report 537, Technical Research Centre of Finland (VTT) (1988) [in Finnish with English abstract].

Laine, J., "Prototype for a low-energy office building", *CADDET Newsletter*, 4, pp. 11-13 (1991).

Laine, J., "An experimental building with new technical systems", *Future Buildings — Innovative Low Energy Concepts* (Edited by A. Sarja and M. Lautanala), pp. 117-123, International Energy Agency (IEA), Future Building Forum Workshop, Espoo, Finland, 1-3 September 1992, Technical Research Centre of Finland (VTT), Espoo (1993).

Laine, J. and Saari, M., "METOP - energy efficient office buildings", *Ventilation for Energy Efficiency and Optimum Indoor Air Quality*, 13th AIVC Conference Proceedings, pp. 115-123, Nice, France, 15-18 September 1992, The Air Infiltration and Ventilation Centre, Coventry (1992).

Laine, J. and Saari, M., "Realization of good indoor climate in METOP low-energy office building", *Indoor Air '93*, The 6th International Conference on Indoor Air Quality and Climate, Volume 5, pp. 401-406, Helsinki (4-8 July 1993).

Desiccant cooling

Belding, W.A., "Open-cycle desiccant Cooling Technology: A Pathway to the Future", Breckenridge, CO (June 23-25, 1993). AFEAS Refrigeration and Air Conditioning Workshop Proceedings

Bradley, T.J., Hamstra, S.A. and Cooley, D., "Operating an Ice Rink Year-Round by Using a Desiccant Dehumidifier to Remove Humidity", ASHRAE Transactions, V. 100, Part 1(1994).

Busweiler, U., "Air conditioning with a combination of radiant cooling, displacement ventilation and desiccant cooling", ASHRAE Transactions, v. 99, Part 2, pp. 503-510 (1993).

Calton, Dean, "Distributed air conditioning in supermarkets", ASHRAE Journal, pp. 40- 44 (May 1992).

Collier, R.K., "Desiccant properties and their effect on cooling system performance" ASHRAE Transactions, v. 95, Pt. 1 (1989).

Czanderna, A.W., "Polymers as Advanced Materials for Desiccant Applications", ASHRAE Transactions, V. 96, Pt. 1 (1990).

The Dehumidification Handbook, Second Edition, Munters Cargocaired, Edited by Harriman, Lewis G. (1990).

Desiccant Cooling and Dehumidification, ASHRAE Technical Committee 3.5, ASHRAE Publications (1992).

Fundamentals, Chapter 19, Sorbents and Desiccants, ASHRAE Handbook (1994).

Goland, Spencer, "Six Primary Applications for Desiccant Dehumidification", Air Conditioning, Heating & Refrigeration News, April 13 (1992).

HVAC Systems and Equipment, Chapter 22 — Desiccant Dehumidification & Pressure Drying Equipment, ASHRAE Handbook (1992).

Henninger, Robert H., "New capabilities of DOE-2 to simulate desiccant cooling systems", Intersociety Energy Conversion Engineering Conference Proceedings, Vol. 2, IEEE, pp. 553-558.

Innovative Cooling Systems, IEA Energy Conservation in Buildings and Community Systems Workshop Report, Solihull (UK) (12-14 May 1992).

Kweller, E., Mei, V.C. and Chen, F.C., "Options of desiccant cooling and dehumidification technology", Intersociety Energy Conversion Engineering Conference Proceedings, IECEC 91, Boston, MA (August 4 - 9, 1991).

Meckler, Milton, Innovative Energy Design for the '90s, Chapter 14 and 15, Fairmont Press, Inc., GA.

"Symposium on the State-of-the-art in Desiccant Cooling Applications", ASHRAE Transactions, V. 94, part 1, pp. 525-596 (1988).

"Symposium on Advances in Desiccant Air Conditioners and Heat Pumps", ASHRAE Transactions, V. 94, part 2, pp. 1997-2042 (1988).

Evaporative cooling

Chen, P.L., Qin, H.M, Huang, Y.J., and Wu, H.F. "A New Heat And Mass Transfer Model for Thermal And Hydraulic Calculation of Indirect Evaporative Coolers", LBL Report 28201, also in ASHRAE Transactions, Vol. 99 (1991). Huang, Y.J., Hanford, J.W., and

Wu, H.F., "Preliminary Evaluation of the Performance, Water Use, and Current Application Trends of Evaporative Coolers in California Climates", Final report to the California Institute of Energy Efficiency, Lawrence Berkeley Laboratory, Berkeley CA (1992).

Huang, Y.J., Wu, H.F. et al., "The Energy and Comfort Performance of Evaporative Coolers for Residential Buildings in California Climates", LBL Report 29799, also in ASHRAE Transactions, Vol. 99 (1991).

Peterson, J.L. and Hunn, B.D., "Experimental Performance of an Indirect Evaporative Cooler", ASHRAE Transactions, Vol. 98 (1992).

Watt, John R., Evaporative Air-Conditioning Handbook, Second edition, New York: Chapman and Hall (1986).

Slab cooling with water

Isoardi, J.P., Le rafraîchissement par le plancher, Promoclim (September 1989).

Michel, E., Dossier plancher rafraîchissant, Revue Promoclim (March - April 1994).

Michel, E., Les installations de rafraîchissement par le sol: Etat de l'art — point de vue des intervenants, European Conference on Energy Performance and Indoor Climate in Buildings, Lyon, France (November 24 - 26, 1994).

Michel, E. and Isoardi, J.P., Le rafraîchissement par le sol, Conference Proceedings from CLIMA 2000, London (1993).

Missenard, F. Andre, Le chauffage et le rafraîchissement par rayonnement, 1st edition, Eyrolles, Paris (1959).

Rio, A. and Gilles, R., Le rafraîchissement par le sol, Conference Proceedings from FRANCOCLIM (1989).

Trancart, Monique, Plancher rafraîchissant: une alternative à la clima légère?, Revue Pratique du Froid (April 1994).

Chilled ceilings and displacement ventilation

Finkelstein, Technik am Bau (TAB), Derzeitiger Stand der Normungs - und Richtlinienarbeit (April 1994).

Laabs, K.D., RUD: OTTO MEYER, Systementwicklung, Gebäudetechnik 2. Statusbericht, Kühldecken mit Turbulenzamer Lüftung (September 1990).

Laabs, K.D., Kühldeckensysteme der "Stillen Kühlung" im Einsatz STULZ-Bericht (September 1993).

Laabs, K.D., STU-Abnahmerichtlinien (December 1993).

Laabs, K.D., Detail Systeme der Stillen Kühlung (February 1995).

Laabs, K. D., Deutsches Ingenieur Blatt, Stille Kühlung gewinnt durch gute Planung (March 1995).

Laabs, K.D. and Wolkenhauer, STULZ GmbH - Klimatechnik, Bericht Nr. 121, Abnahmemessung 4.OG Hamburgische Landesbank (December 1994).

Ground Cooling with Water Using Aquifers

Aquifer-Thermal Energy Storage, Proceedings of the international symposium, University of Alabama, Tuscaloosa, Alabama (November 1994).

Calorstock '94, 6th International Conference on Thermal Energy Storage Proceedings, Vol. 1 and 2, Espoo, Helsinki, Finland (August 1994).

Hadorn, Jean Christophe, Guide to seasonal heat storage, Swiss Association of Engineers and Architects, Federal Energy Office, Switzerland (1990)

"Summary of National State of the Art Reviews", IEA Annex 7 — Innovative and Cost-effective Seasonal Cold Storage Applications, Public Works Canada (1992).