

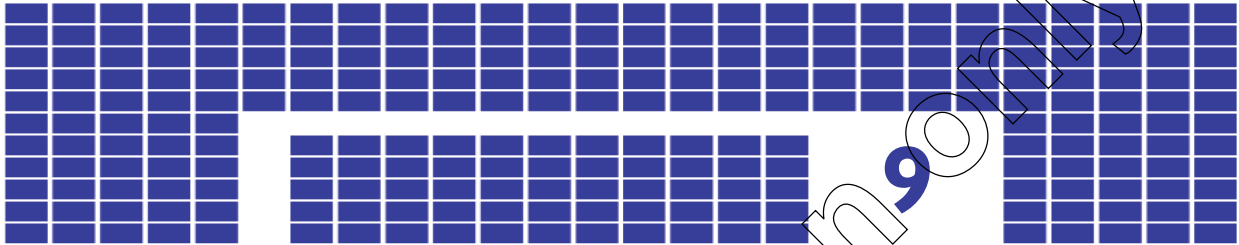

Housing, Family and Social Statistics Division
General Social Survey 1994

Cycle 9: Education, Work and Retirement

Questionnaire Package



Statistics
Canada

Statistique
Canada

Canada

For information only

For information only

GENERAL SOCIAL SURVEY

Cycle 9 Questionnaire Package

This package describes the content, methodology and sample of the ninth cycle of the General Social Survey (GSS). Copies of the questionnaires used in Cycle 9 are attached as appendices: the GSS 9-1 control form as Appendix A and the GSS 9-2 questionnaire on education, work and retirement as Appendix B. Since Cycle 9 uses a Computer Assisted Telephone Interviewing System (CATI), the attached documents are only presented as reference tools.

Content and Methodology

The purpose of the General Social Survey is to monitor the evolution of major social phenomena in Canada and to measure changes in Canadians' demographics, social characteristics and living conditions. Each of the five core content areas of the General Social Survey is treated every five years. These areas are: health; time use; personal risk; education, work and retirement; and family and friends.

Cycle 9 marks the first repeat of the education, work and retirement core content area originally covered in Cycle 4. Although the core content is the same in both cycles, there are differences between the two surveys. For example, Cycle 9 focuses more on quality of life after retirement and post-retirement activities than Cycle 4. In addition, the Cycle 9 questionnaire has two new sections: social origin and work interruptions.

A GSS 9-1 control form is completed for each telephone number generated in the sample. When a private household is contacted, all household members are enumerated and basic demographic information (eg. age, sex, marital status and relationship to the selected respondent) is collected for each. The person who is to answer the questionnaire is then randomly selected by the computer. Proxy interviews are not accepted.

The GSS 9-2 questionnaire has the following sections:

- A. Education screen
- B. Current education
- C. After education
- D. Before education
- E. Future education
- G. Work screen
- H. Employed
- J. Persons not employed
- K. Retired
- L. Work interruptions
- M. Social origin
- N. Computer use and related material
- P. Other classification

Section A is designed primarily to collect information on educational attainment, field of study, reason for not continuing in school (where applicable), and province and language of education. As well, this section classifies respondents according to their educational status at the time of the survey: those who are currently studying go to Section B, whereas those who are not, go to Section C.

Section B focuses on current studies and contains questions on field of study, the level the respondent is working towards, and province and language of education. Section C collects information on the respondents' activities after they completed their studies (including first job), and Section D covers activities prior to the most recent educational program. Finally, Section E collects information on the respondents' education plans.

Section G collects information which screens respondents according to their labour market activity: persons with a job at present go to Section H; persons who did not work during the past 12 months go to Section J; and retired persons go to Section K. Section G also asks respondents who are not employed at the time of the survey but worked during the past 12 months a series of employment-related questions.

Section H contains a range of questions on current employment. In addition to occupation and industry, questions about hours of work, employee supervision, union membership, stress in the work environment, computer use, intrinsic and extrinsic work rewards, etc. are asked. The last questions in this section provide information on the respondents' work activities during the past five years. Section J repeats these last questions for persons not employed at the time of the survey, and asks respondents about the reasons for their unemployment.

Section K is for retired persons. In addition to the traditional questions about quality of life after retirement, it contains a number of questions on post-retirement activity: jobs held since retirement, reason for return to the labour market, working conditions, etc.

Section L concerns work interruptions during the past five years and their impact on the respondents' occupational situation. Section M pertains to social origin and provides information on the level of education and occupation of the respondent's parents. Use of computers and automated technology in everyday life is dealt with in Section N. Lastly, Section P covers the respondents' sociodemographic characteristics such as language, religion, state of health, and income, as well as some information on their spouse's activity, where applicable.

Data Collection

As in Cycle 8, data are being collected by means of computer-assisted telephone interviewing (CATI) using CASES software. In CATI, the interviewer asks the respondent the survey questions as they appear on the screen and uses the keyboard to enter the responses into the computer system as the interview progresses. Built-in edits and fewer processing steps result in improved data quality and reduced processing time.

CATI differs from the collection method used for Cycles 1 to 7 of the GSS. Specifically, random selection of the respondent is now performed by the computer, and it is no longer necessary to use the preprinted selection label. In addition, CATI asks the respondent to provide information on the relationship of each household member to the selected respondent, whereas in previous cycles, only the relationship with a designated person in each economic family was requested. As well, although shown in the questionnaire in appendix, the skips are built into CATI and do not appear on the screen.

Lastly, a few questions are worded differently in CATI. For example, instead of asking for date of birth, CATI asks three separate questions: year of birth, month of birth and day of birth.

Sample

The target population of the 1994 General Social Survey consists of all persons aged 15 and over living in the ten provinces, except persons residing full-time in institutions. The sample population is selected through random digit dialing (RDD).

The data for this cycle were collected monthly from January 1994 to December 1994 inclusive. Collection took place in four regional offices: Halifax, Montreal, Winnipeg and Vancouver.

The sample for Cycle 9 comprises 11,500 respondents, including 10,000 persons aged 15 and over who make up the main sample and an additional sample of 1,500 respondents aged 55 to 74. This second sample was added primarily to improve estimates of the population of retired persons who return to the labour force. It was created using the rotating groups from the Labour Force Survey and added to the regular GSS sample. These additional cases are included in the random digit dialing process. Statistics Canada's head office selects the telephone numbers, which are then sent to the regional offices. For each household in the additional sample, a respondent aged 55 to 74 is randomly selected for an interview. The expected response rate for Cycle 9 is approximately 82%.

For information only

For information only

APPENDIX A

General Social Survey Control Form GSS 9.1

Confidential when completed. Collected under the authority of the Statistics Act, Revised Statutes of Canada, 1985, Chapter S19.

1. Hello, I'm "Name of the interviewer" from Statistics Canada. We're calling you for a study on education, work and retirement.

2. I'd like to make sure that I've dialed the right number. Is this.....(read number)?

3. All information that we collect in this voluntary study will be kept strictly confidential. Your participation is essential if the results are to be accurate. My supervisor is working with me today and may listen to the interview to evaluate the survey.

4. Is this the number for a private home, a business an institution or a vacation home?

Private home.....¹ 0 >>> 7
 Both home and
 business.....² 0 >>> 7
 Business, institution
 or other non
 residence.....³ 0
 Vacation home.....⁴ 0
 Do not know.....^X 0
 Refused.....^R 0

5. Does anyone use this telephone number as a home phone number?

Yes.....¹ 0
 No.....³ 0 >>> Thank respondent and
 END
 Do not know.....^X 0
 Refused.....^R 0

6. How many people live or stay at this address without a usual place of residence elsewhere and use this number as a home phone number?

None.....¹ 0 >>> Thank respondent
 and END
 1 or more.....² 0
 Do not know.....^X 0
 Refused.....^R 0

7. I need to select one person from your household for an interview. What is the first name and age, of each person living or staying there who doesn't have a residence elsewhere? Please start with the oldest.

(Enter names and ages in items Z2 and Z4).

INTERVIEWER: Enter the sex(item Z5) of each person recorded in item Z2.

8. What is ... (Name of each person recorded in item Z2) ...'s marital status? Is it:

Married / common-law..... 1 0
 Single..... 2 0
 Widow / widower..... 3 0
 Divorced /
 Separated..... 4 0
 Do not know..... X 0
 Refused..... R 0

9. What is... (Name of each person recorded in item Z2) ...'s relationship to ... (selected respondent)?

Spouse..... 2 0
 Partner..... 3 0
 Son or daughter (natural, adopted or step)..... 4 0
 Foster child..... 5 0
 Father or mother..... 6 0
 Sister or brother..... 7 0
 Grandchild..... 8 0
 Grandfather or grandmother..... 9 0
 Daughter-in-law or son-in-law..... 10 0
 Father-in-law / mother-in-law/Stepmother/Stepfather..... 11 0
 Sister-in-law or brother-in-law..... 12 0
 Niece or nephew..... 13 0
 Aunt or uncle..... 14 0
 Cousin..... 15 0
 Other relative..... 16 0
 Other non-relative..... 17 0
 Do not know..... X 0
 Refused..... R 0

(enter in item Z7)

10. Is there another person to be added?

Yes..... 1 0▶▶▶ 7
 No..... 3 0
 Do not know.. X 0
 Refused..... R 0

11. Is there anyone who usually lives there that you may have left out such as a child, someone temporarily away (attending school, visiting, in hospital, travelling), another relative, a roomer or boarder, or an employee?

Yes..... 1 0▶▶▶ 7
 No..... 3 0
 Do not know.. X 0
 Refused..... R 0

12. The person I am to interview is... (Name of selected respondent) Is he/she there?

Yes..... 1 0▶▶▶ Go to Form GSS 9-2
 No..... 3 0▶▶▶ Set up appointment

Z1. Nº of the Household member	Z2. Name of the Household Members	Z3. Selection Nº	Z4. Age	Z5. Sex		Z6. Marital Status	Z7. Relationship with selected respondent
				M	F		
1			_ _ _				
2			_ _ _				
3			_ _ _				
4			_ _ _				
5			_ _ _				
6			_ _ _				
7			_ _ _				
8			_ _ _				
9			_ _ _				
10			_ _ _				
11			_ _ _				
12			_ _ _				
13			_ _ _				
14			_ _ _				
15			_ _ _				
16			_ _ _				
17			_ _ _				
18			_ _ _				
19			_ _ _				
20			_ _ _				

APPENDIX B

For information only

For information only

GENERAL SOCIAL SURVEY, CYCLE 9

Education, Work and Retirement

GSS 9-2

Table of Contents

Introduction:	Relationship of Household Members
Section A:	EDUCATION SCREEN
Section B:	CURRENT EDUCATION
Section C:	AFTER EDUCATION
Section D:	BEFORE EDUCATION
Section E:	FUTURE EDUCATION
Section G:	WORK SCREEN
Section H:	EMPLOYED
Section J:	PERSONS NOT EMPLOYED
Section K:	RETIRED
Section L:	WORK INTERRUPTIONS (MOST RECENT, PREVIOUS)
Section M:	(SOCIAL ORIGIN
Section N:	COMPUTER USE AND RELATED MATERIAL
Section P:	OTHER CLASSIFICATION

General Social Survey

Questionnaire on Education, Work and Retirement. GSS 9-2

Hello, I'm "name of interviewer" from Statistics Canada. We are calling you for a survey on education, work and retirement. All information we collect in this voluntary survey will be kept strictly confidential. Your participation is essential if the survey results are to be accurate.

SECTION A : EDUCATION SCREEN

A2. First I would like to ask you some questions about your education.

A3. Excluding kindergarten, how many years of elementary and high school education have you successfully completed?

- No schooling 00 0▶▶▶D19
- One to five years 01 0▶▶▶A5
- Six 06 0▶▶▶A5
- Seven 07 0▶▶▶A5
- Eight 08 0▶▶▶A5
- Nine 09 0▶▶▶A5
- Ten 10 0
- Eleven 11 0
- Twelve 12 0
- Thirteen 13 0
- Don't know x 0
- Refused r 0

A4. Have you graduated from high school?

- Yes 1 0▶▶▶A8
- No 3 0
- Don't know x 0▶▶▶A12
- Refused r 0▶▶▶A12

A5. Are you currently working towards elementary or high school graduation?

- Yes 1 0
- No 3 0▶▶▶A7
- Don't know x 0▶▶▶A8
- Refused r 0▶▶▶A8

A6. Is it an elementary or a high school graduation?

- Elementary 1 0
- High school 2 0
- Don't know x 0
- Refused r 0

go to B6

A7. What was the MOST IMPORTANT REASON why you did not continue or finish elementary or high school?

(Enter one only)

- No main reason 00 0
- School related reasons
- Boredom 01 0
- Problems with school work .. 02 0
- Teacher problems 03 0
- Bad results 04 0
- Expelled 05 0
- Skipped classes 06 0

Personal or family reasons

- Pregnancy/take care of children 07 0
- Marriage 08 0
- Lack of time 09 0
- Problems at home 10 0
- Drug and alcohol problems .. 11 0
- To help at home 12 0
- Own illness, disability or accident 13 0

Work related reasons

- Had to work/financial reasons 14 0
- Preferred work to school 15 0
- Other reasons 16 0
- (specify) _____
- Don't know x 0
- Refused r 0

GSS Cycle 9 Questionnaire

A8. In which province or territory did you attend most of your elementary and high school studies/schooling?

- Newfoundland 10 0
- Prince Edward Island 11 0
- Nova Scotia 12 0
- New Brunswick 13 0
- Quebec 14 0
- Ontario 15 0
- Manitoba 16 0
- Saskatchewan 17 0
- Alberta 18 0
- British Columbia 19 0
- Yukon Territory 20 0
- Northwest Territories 21 0

- Foreign Country 22 0

- China 01 0
- England 02 0
- France 03 0
- Germany 04 0
- Haiti 05 0
- Holland 06 0
- India 07 0
- Ireland 08 0
- Italy 09 0
- Jamaica 10 0
- Philippines 11 0
- Poland 12 0
- Portugal 13 0
- Scotland 14 0
- United States 15 0
- Commonwealth of Soviet States 16 0
- Other 17 0
(specify) _____

- Don't know x 0
- Refused r 0

A9. Which languages were used for teaching your courses, excluding language courses?

- English 1 0
- French 2 0
- Other 3 0
(specify) _____

- Don't know x 0
- Refused r 0

If more than one language is declared, go to A10 otherwise go to A11.

A10. Which was used most often?

- English 1 0
- French 2 0
- Other 3 0
(specify) _____

- Don't know x 0
- Refused r 0

A11. Have you had any further schooling beyond high school?

- Yes 1 0
- No 3 0▶▶▶C1
- Don't know x 0▶▶▶C1
- Refused r 0▶▶▶C1

GSS Cycle 9 Questionnaire

A12. In which province or territory did you undertake your last educational program, completed or not?

- Newfoundland 10 0
- Prince Edward Island 11 0
- Nova Scotia 12 0
- New Brunswick 13 0
- Quebec 14 0
- Ontario 15 0
- Manitoba 16 0
- Saskatchewan 17 0
- Alberta 18 0
- British Columbia 19 0
- Yukon Territory 20 0
- Northwest Territories 21 0

- Foreign Country 22 0

- China 23 0
- England 02 0
- France 03 0
- Germany 04 0
- Haiti 05 0
- Holland 06 0
- India 07 0
- Ireland 08 0
- Italy 09 0
- Jamaica 10 0
- Philippines 11 0
- Poland 12 0
- Portugal 13 0
- Scotland 14 0
- United States 15 0
- Commonwealth of Soviet States 16 0
- Other 17 0
- (specify) _____

- Don't know x 0
- Refused r 0

A13. Which languages WERE/ARE USED for teaching your courses at this level, excluding language courses?

- English 1 0
- French 2 0
- Other 3 0
- (specify) _____

- Don't know x 0
- Refused r 0

If more than one language is declared, go to A14 otherwise go to A15

A14. Which was used most often?

- English 1 0
- French 2 0
- Other 3 0
- (specify) _____

- Don't know x 0
 - Refused r 0
-

GSS Cycle 9 Questionnaire

A15. What is the highest level of education that you have ATTAINED? (Enter one only and verify whether or not studies have been completed)

- Earned doctorate (e.g. Ph.D., D.Sc., D.Ed.) ¹ 0▶▶▶A20
- Some graduate studies at doctorate level ² 0▶▶▶A16
- Master's degree (e.g. M.A., M.Sc., M.Ed.) ³ 0▶▶▶A20
- Some graduate studies at Master's level ⁴ 0▶▶▶A16
- University certificate or diploma above bachelor level ⁵ 0▶▶▶A20
- First professional degree in medicine (M.D.), dentistry (D.D.S., D.M.D.), veterinary medicine (D.V.M.), law (L.B.), optometry (O.D.) or divinity (M.DIV.), or 1-year B.Ed. after a Bachelor's degree ⁶ 0▶▶▶A20
- Bachelor's degree (e.g. B.A., B.Sc., B.A.Sc., B.Ed.) ⁷ 0▶▶▶A20
- University certificate or diploma below bachelor level ⁸ 0▶▶▶A20
- Some university ⁹ 0▶▶▶A16
- Diploma or certificate from community college, CEGEP or nursing school ¹⁰ 0▶▶▶A20
- Some community college, CEGEP or nursing school ... ¹¹ 0▶▶▶A16
- Diploma or certificate from trade, technical or vocational school, or business college ¹² 0▶▶▶A20
- Some trade, technical or vocational school, or business or college ¹³ 0▶▶▶A16
- Other ¹⁴ 0
- (specify) _____
- Don't know ^x 0▶▶▶A20
- Refused ^r 0▶▶▶A20

A15a. Were they partial or completed studies?

- Partial Studies ¹ 0
- Completed Studies ² 0▶▶▶A20
- Don't know ^x 0▶▶▶A20
- Refused ^r 0▶▶▶A20

A16. Regarding this highest level attained, were you working towards a degree, diploma or certificate?

- Yes ¹ 0
- No ³ 0▶▶▶A19
- Don't know ^x 0▶▶▶A19
- Refused ^r 0▶▶▶A19

A17. Are you still working towards your degree, diploma or certificate?

- Yes ¹ 0▶▶▶B1
- No ³ 0
- Don't know ^x 0▶▶▶A19
- Refused ^r 0▶▶▶A19

GSS Cycle 9 Questionnaire

A18. What was the MOST IMPORTANT REASON why you decided not to continue your studies?

(Enter one only)

No main reason 00 0

School related reasons

Boredom 01 0

Problems with school work .. 02 0

Teacher problems 03 0

Bad results 04 0

Expelled 05 0

Skipped classes 06 0

Personal or family reasons

Pregnancy/take care of children 07 0

Marriage 08 0

Lack of time 09 0

Problems at home 10 0

Drug and alcohol problems .. 11 0

To help at home 12 0

Own illness, disability or accident 13 0

Work related reasons

Had to work/financial reasons 14 0

Preferred work to school 15 0

Other reasons 16 0

(specify) _____

Did not want to obtain any degree, certificate or diploma 17 0

Don't know x 0

Refused r 0

A19. What is the highest degree, diploma or certificate that you have completed?

(Enter one only)

Earned doctorate (e.g. Ph.D., D.Sc., D.Ed.) 01 0

Master's degree (e.g. M.A., M.Sc., M.Ed.) 02 0

University certificate or diploma above bachelor level 03 0

First professional degree in medicine (M.D.), dentistry (D.D.S., D.M.D.), veterinary medicine (D.V.M.), law (LL.B.), optometry (O.D.) or divinity (M.DIV.), or 1-year B.Ed. after a Bachelor's degree 04 0

Bachelor's degree (e.g. B.A., B.Sc., B.A.Sc., B.Ed.) 05 0

University certificate or diploma below bachelor level 06 0

Diploma or certificate from community college, CEGEP or nursing school 07 0

Diploma or certificate from trade, technical or vocational school, or business college 08 0

High school diploma 09 0 ▶▶▶A22

Less than high school diploma 10 0 ▶▶▶A22

Other 11 0

(specify) _____

Don't know x 0 ▶▶▶A22

Refused r 0 ▶▶▶A22

For information only

GSS Cycle 9 Questionnaire

A20 What was the major field of study or specialization for your degree, diploma or certificate?

Don't know x 0▶▶A22
Refused r 0▶▶A22

A21. What was your MAIN REASON for choosing this field of study?
(Enter one reason only)

- To prepare for first career 1 0
- To change careers 2 0
- To improve career 3 0
- To improve earnings 4 0
- To improve knowledge 5 0
- Because of interest in the subject 6 0
- Other 7 0
- (Specify) _____
- Don't know x 0
- Refused r 0

A22. Are you now working towards a different degree, diploma or certificate?

- Yes 1 0▶▶B1
- No 3 0▶▶C1
- Don't know x 0▶▶C1
- Refused r 0▶▶C1

For information only

GSS Cycle 9 Questionnaire

SECTION B: CURRENT EDUCATION

B1. Now, a few questions about the educational program you are currently working on.

B2. What degree, diploma or certificate are you working towards?
(Enter one only)

- Earned doctorate (e.g. Ph.D, D.Sc., D.Ed.) 1 0
- Master's degree (e.g. M.A., M.Sc., M.Ed.) 2 0
- University certificate or diploma above bachelor level 3 0
- First professional degree in medicine (M.D.), dentistry (DDS., D.M.D.), veterinary medicine (D.V.M.), law (L.L.B.), optometry (O.D.) or divinity (M.DIV.), or 1-year B.Ed. after a Bachelor's degree 4 0
- Bachelor's degree (e.g. B.A., B.Sc., B.A.Sc., B.Ed.) 5 0
- University certificate or diploma below bachelor level 6 0
- Diploma or certificate from community college, CEGEP or nursing school 7 0
- Diploma or certificate from trade, technical or vocational school, or business college 8 0
- Other 9 0
(specify) _____
- Don't know x 0 ▶▶▶D1
- Refused r 0 ▶▶▶D1

B3. What is the major field of study or specialization for that degree, diploma or certificate?

- Don't know x 0
- Refused r 0

B4. What was your MAIN REASON for choosing this field of study?

(Enter one reason only)

- To prepare for first career 1 0
- To change career 2 0
- To improve career 3 0
- To improve earnings 4 0
- To improve knowledge 5 0
- Because of interest in the subject 6 0
- Other 7 0
(Specify) _____
- Don't know x 0
- Refused r 0

B5. In what year do you expect to complete this program?

- 1
- 2
- 3
- 4
- 5
- 6
- 7
- 8
- 9
- Don't know x 0
- Refused r 0

If A12 does not equal "blank", go to B9

GSS Cycle 9 Questionnaire

B6. In which province or territory are you now studying?

- Newfoundland 10 0
- Prince Edward Island 11 0
- Nova Scotia 12 0
- New Brunswick 13 0
- Quebec 14 0
- Ontario 15 0
- Manitoba 16 0
- Saskatchewan 17 0
- Alberta 18 0
- British Columbia 19 0
- Yukon Territory 20 0
- Northwest Territories 21 0

Foreign Country 22 0

- China 01 0
- England 02 0
- France 03 0
- Germany 04 0
- Haiti 05 0
- Holland 06 0
- India 07 0
- Ireland 08 0
- Italy 09 0
- Jamaica 10 0
- Philippines 11 0
- Poland 12 0
- Portugal 13 0
- Scotland 14 0
- United States 15 0
- Commonwealth of Soviet States 16 0
- Other 17 0

(specify) _____

- Don't know x 0
- Refused r 0

B7. Which languages are used for teaching your courses in this educational program, excluding language courses?

- English 1 0
 - French 2 0
 - Other 3 0
- (specify) _____

- Don't know x 0
- Refused r 0

If more than one language is declared, go to B8, otherwise go to B9.

B8. Which one are you using most often?

- English 1 0
 - French 2 0
 - Other 3 0
- (specify) _____

- Don't know x 0
- Refused r 0

B9. During the last 12 months did you take AT LEAST ONE course or pursue any work for this program?

(For example, thesis work)

- Yes 1 0
- No 3 0 → D1
- Don't know x 0 → D1
- Refused r 0 → D1

B10. Were you mainly a full-time or a part-time student?

- Full-time 1 0
- Part-time 3 0
- Don't know x 0
- Refused r 0

Go to D1.

GSS Cycle 9 Questionnaire

SECTION C: AFTER EDUCATION

C1. Now, a few questions that refer to the time when you completed your...(highest level of education)

C2. In what year did you complete your studies?

□□□□

Don't know x 0
 Refused r 0

C3. Did you have a job during the 6 months before you completed your studies?
 (Exclude summer jobs)

Yes 1 0
 No 3 0▶▶C5
 Don't know x 0▶▶C5
 Refused r 0▶▶C5

C4. During that time, on average how many hours per week did you work at that job?

□□□□ (1-100) hour(s)

Don't know x 0
 Refused r 0

C5. During the 12 months after you completed these studies, was your main activity working at a job or a business, looking for work, going to school, keeping house, retired or something else

(Enter one only)

(Note: if respondent indicates a short illness, ask what the usual main activity was)

Working at a job or business? . 1 0▶▶C11
 Looking for work? . 2 0
 Going to school . 3 0
 Keeping house? . 4 0
 Retired? . 5 0
 Something else:
 Maternity/paternity leave 6 0
 Long term illness 7 0
 Other 8 0
 (specify) _____

Don't know x 0▶▶C7
 Refused r 0▶▶C7

C6. Did you have a job or were you self-employed at any time during those 12 months?

Yes 1 0▶▶C11
 No 3 0
 Don't know x 0
 Refused r 0
 Has never worked before 5 0▶▶D1

C7. Have you ever had a job since completing your studies?

Yes 1 0
 No 3 0▶▶D1
 Don't know x 0▶▶D1
 Refused r 0▶▶D1

C8. After completing your studies, in what year did you get your first job ?

□□□□

Don't know x 0
 Refused r 0

For information only

GSS Cycle 9 Questionnaire

C9. For whom did you work at that job? (Name of business, government department or agency, or person)

Don't know x 0
 Refused r 0

Go to C12.

C11. During those 12 months, for whom did you work for at your first job?

(Name of business, government department or agency, or person)

Don't know x 0
 Refused r 0

C12. What kind of business, industry or service was this?

(Give full description: e.g. federal government, canning industry, forestry services)

Don't know x 0
 Refused r 0

C13. What kind of work were you doing?

(Give a full description: e.g. office clerk, factory worker, forestry technician)

Don't know x 0
 Refused r 0

C14. In that work, what were your most important activities or duties?

(Give a full description: e.g. filing documents, drying vegetables, forestry examiner)

Don't know x 0
 Refused r 0

C15. Were you mainly...

an employee working for someone else? ¹ 0

self-employed? ² 0

Don't know x 0

Refused r 0

C16. Were you a union member at work?

Yes ¹ 0 → C18

No ³ 0

Don't know x 0

Refused r 0

C17. Were you normally covered by a contract or a collective agreement?

Yes ¹ 0

No ³ 0

Don't know x 0

Refused r 0

C18. Was this work mostly full-time or part-time?

Full-time ¹ 0

Part-time ² 0

Other (contract, shared job, etc) ³ 0
 (specify) _____

Don't know x 0

Refused r 0

GSS Cycle 9 Questionnaire

C19. How closely was that job related to your education?
Was it...

- Closely related? 1 0
 - Somewhat related? 2 0
 - Not at all related? 3 0
 - Don't know x 0
 - Refused r 0
-

For information only

GSS Cycle 9 Questionnaire

SECTION D: BEFORE EDUCATION

D1. Now a few questions referring to the time when you started the studies for your... (highest level of education)

D2. How old were you when you started these studies?

|||

Don't know x 0▶▶E1
 Refused r 0

If D2 is less than 15, go to E1

D4. During the 12 months before you started these studies, was your main activity working at a job or a business, looking for work, going to school, keeping house, retired or something else?
 (Enter one only)

(Note: if respondent indicates a short illness, ask what is the usual main activity)

Working at a job or business .. 1 0▶▶D10
 Looking for work 2 0
 Going to school 3 0
 Keeping house 4 0
 Retired 5 0
 Something else:
 Maternity/paternity leave 6 0
 Long term illness 7 0
 Other 8 0

(specify)

Don't know x 0
 Refused r 0

D5. Before starting the program, had you ever held a full-time job for 6 months or more?
 (Exclude summer jobs)

Yes 1 0
 No 3 0▶▶E1
 Don't know x 0▶▶E1
 Refused r 0▶▶E1
 Has never worked before 5 0▶▶E1

D6. How many months or years of total full-time work experience did you have before you started your program?

6 months to less than
 1 year 1 0
 1 to less than 3 years 2 0
 3 to less than 5 years 3 0
 5 to less than 7 years 4 0
 7 years or more 5 0
 Don't know x 0
 Refused r 0

D7. Before starting your program, in what year did you stop working at a full-time job that lasted six months or more?

|||

Still working at the same job .. 0 0▶▶E1
 Don't know x 0▶▶E1
 Refused r 0▶▶E1

D8. For whom did you work at that job?
 (Name of business, government department or agency, or person)

Don't know x 0
 Refused r 0

Go to D12.

D10. Are you still working at this job?

Yes 1 0▶▶E1
 No 3 0
 Don't know x 0▶▶E1
 Refused r 0▶▶E1

GSS Cycle 9 Questionnaire

D11. For whom did you work the longest time during those 12 months? (Name of business, government department or agency, or person)

Don't know x 0
 Refused r 0

D12. What kind of business, industry or service was this? (Give full description: e.g. federal government, canning industry, forestry services)

Don't know x 0
 Refused r 0

D13. What kind of work were you doing? (Give a full description: e.g. office clerk, factory worker, forestry technician)

Don't know x 0
 Refused r 0

D14. In that work, what were your most important activities or duties? (Give a full description: e.g. filing documents, drying vegetables, forestry examiner)

Don't know x 0
 Refused r 0

D15. Were you mainly...

an employee working for someone else? 1 0
self-employed? 2 0
 Don't know x 0
 Refused r 0

D16. Were you a union member at work?

Yes 1 0 ▶▶ D18
 No 3 0
 Don't know x 0
 Refused r 0

D17. Were you normally covered by a contract or a collective agreement?

Yes 1 0
 No 3 0
 Don't know x 0
 Refused r 0

Go to E1.

D19. As of the age of 15 years old, with whom did you have your first full-time job?

(Name of business, government department or agency, or person)

Has never worked before 0 0 ▶▶ E1
 Don't know x 0
 Refused r 0

D20. What kind of business, industry or service was this?

(Give full description: e.g. federal government, canning industry, forestry services)

Don't know x 0
 Refused r 0

GSS Cycle 9 Questionnaire

D21. What kind of work were you doing?
(Give a full description: e.g. office clerk, factory worker, forestry technician)

Don't know x 0
Refused r 0

D22. In that work, what were your most important activities or duties?
(Give a full description: e.g. filing documents, drying vegetables, forestry examiner)

Don't know x 0
Refused r 0

D23. Were you mainly...

**an employee working
for someone else?** 1 0
self-employed? 2 0
Don't know x 0
Refused r 0

D24. Were you a union member at work?

Yes 1 0▶▶E1
No 3 0
Don't know x 0
Refused r 0

D25. Were you normally covered by a contract or a collective agreement?

Yes 1 0
No 3 0
Don't know x 0
Refused r 0

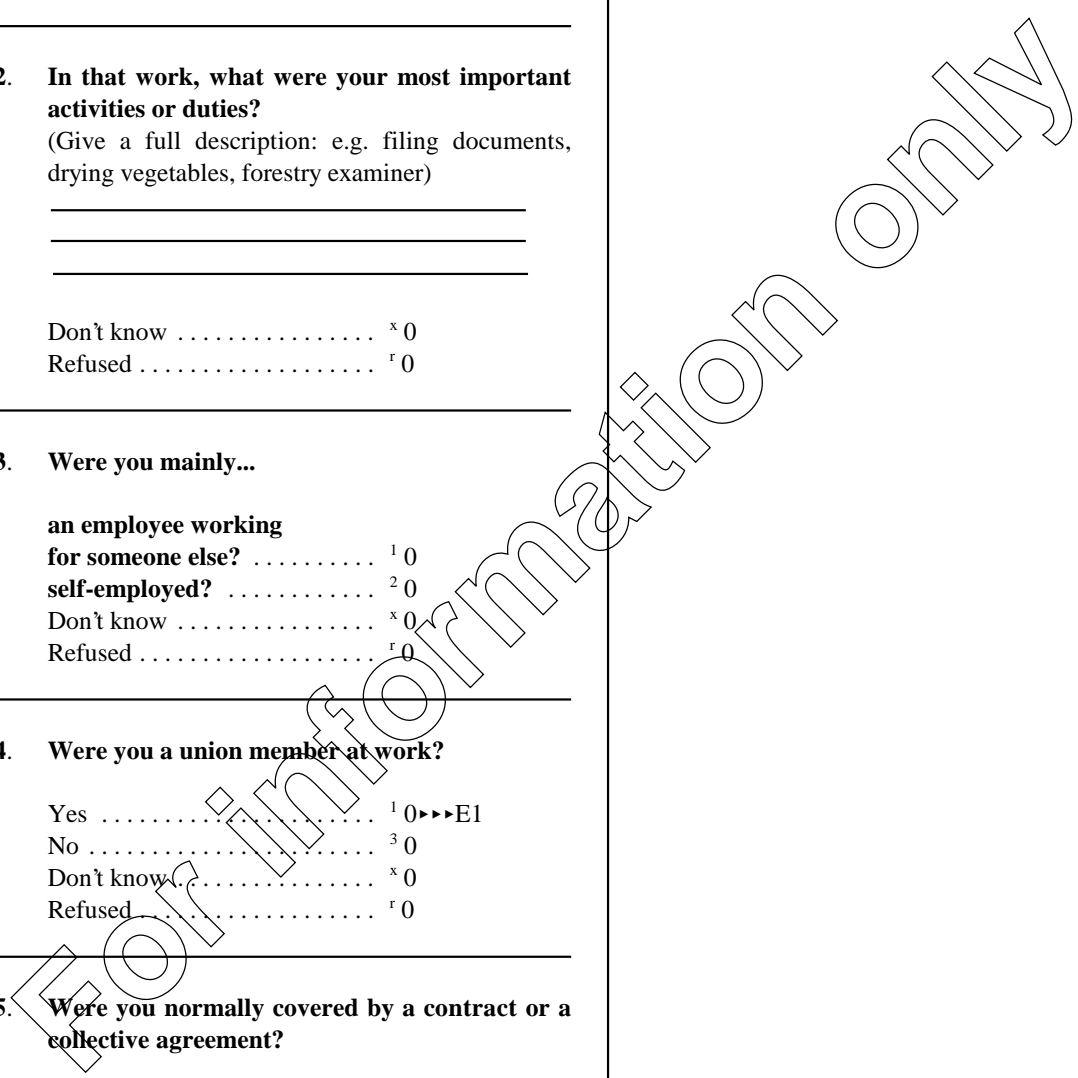

GSS Cycle 9 Questionnaire

SECTION E: FUTURE EDUCATION

E1. In the next five years, do you plan to start a new educational or training program?
(Include part-time and full-time)

- Yes 1 0
- No 3 0▶▶G1
- Don't know x 0▶▶G1
- Refused r 0▶▶G1

E2. What was your MAIN REASON for planning to do this?
(Enter one reason only)

- To prepare for first career 1 0
- To change career 2 0
- To improve career 3 0
- To improve earnings 4 0
- To improve knowledge 5 0
- Because of interest in
the subject 6 0
- Other 7 0
(Specify) _____
- Don't know x 0
- Refused r 0

E3. What is the next degree, diploma or certificate you would like to obtain?

- Earned doctorate (e.g. Ph.D, D.Sc., D.Ed.) 01 0
- Master's degree (e.g. M.A., M.Sc., M.Ed.) 02 0
- University certificate or diploma above bachelor level 03 0
- First professional degree in medicine (M.D.), dentistry (DDS., D.M.D.), veterinary medicine (D.V.M.), law (LL.B.) optometry (O.D.) or divinity (M.Div.) or 1-year B.Ed. after a Bachelor's degree 04 0
- Bachelor's degree (e.g. B.A., B.Sc., B.A.Sc., B.Ed.) 05 0
- University certificate or diploma below bachelor level 06 0
- Diploma or certificate from community college, CEGEP or nursing school ... 07 0
- Diploma or certificate from trade, technical or vocational school, or business college 08 0
- Elementary/High school diploma 09 0▶▶G1
- Other 10 0
(specify) _____
- Does not want to obtain any degree or diploma 11 0
- Don't know x 0▶▶G1
- Refused r 0▶▶G1

E4. What would be your major field of study or specialization?

- Don't know x 0
- Refused r 0

For information only

GSS Cycle 9 Questionnaire

SECTION G: WORK SCREEN

Now some questions about your activities in the last 12 months.

G2. During the past 12 months, that is from "month" 1993 to "month" 1994, was your main activity working at a job or business, looking for work, going to school, keeping house, retired or something else?

(Enter one only) (Note: If sickness or short-term illness is reported, ask for usual major activity)

- Working at a job or business ¹ 0▶▶▶G9
- Looking for work ² 0
- Going to school ³ 0
- Keeping house ⁴ 0
- Retired ⁵ 0
- Something else
- Maternity/paternity leave ⁶ 0
- Long term illness ⁷ 0
- Other ⁸ 0
- (specify) _____

- Don't know ^x 0
- Refused ^r 0

If C6= "has never worked before", go to G6

G3. Did you have a job or were you self-employed at any time during these 12 months?

- Yes ¹ 0▶▶▶G9
- No ³ 0
- Don't know ^x 0
- Refused ^r 0

G4. Last week, did you do any work at a job or business?

- Yes ¹ 0▶▶▶H1
- No ³ 0
- Don't know ^x 0

G5. In the last four weeks, did you look for a job?

- Yes ¹ 0▶▶▶J1
- No ³ 0
- Don't know ^x 0
- Refused ^r 0

G6. During last week, was your main activity going to school, keeping house, retired or something else?

(Enter one only)

(Note: If sickness or short-term illness is reported, ask for usual major activity)

- Going to school ³ 0▶▶▶J7
- Keeping house ⁴ 0▶▶▶J4
- Retired ⁵ 0▶▶▶G8
- Something else:
- Maternity/paternity leave ⁶ 0
- Long term illness ⁷ 0
- Other ⁸ 0

(specify) _____

- Don't know ^x 0
- Refused ^r 0

Go to J7.

G8. Have you ever worked at a job or business?

- Yes ¹ 0▶▶▶K1
- No ³ 0▶▶▶J42
- Don't know ^x 0▶▶▶J42
- Refused ^r 0▶▶▶J42

For question G9, use G2 time frame.

GSS Cycle 9 Questionnaire

G9. For how many weeks during these 12 months did you do any work at a job or business? (time frame: "month" 1993 to "month" 1994)
 (Include vacation, illness, strikes, lock-outs and maternity /paternity leave. The number of weeks worked includes all jobs during this period).

[_ _] weeks

Don't know x 0
 Refused r 0

G10. Last week, did you do any work at a job or business?

Yes 1 0 ▶▶▶ H1
 No 3 0
 Don't know x 0
 Refused r 0

G10a Last week, did you have a job to which you expected to return?

Yes 1 0
 No 3 0 ▶▶▶ G11
 Don't know x 0 ▶▶▶ G11
 Refused r 0 ▶▶▶ G11

G10b Why did you not work at this job last week?
 (Enter one only)

Own illness or disability 1 0
 Vacation 2 0
 Maternity/Paternity leave 3 0
 Personal or family responsibilities 4 0
 Layoff, expects to return (paid workers only) 5 0
 Labour dispute (strike or lockout) 6 0
 Bad weather 7 0
 Seasonal business (exclude paid workers) 8 0 ▶▶▶ G11
 New job to start in future 9 0 ▶▶▶ G11
 Other 0 0 ▶▶▶ G11
 (specify) _____

Don't know x 0
 Refused r 0

G10c. The next questions ask about the job you had last week and to which you expect to return.

Go to H1.

G11. For whom did you last work?

(Name of business, government department or agency, or person)
 Enter 1 if same employer as in C9 or C11 or D8 or D19 (Employer's name) 0 ▶▶▶ G13

Don't know x 0
 Refused r 0

For information only

GSS Cycle 9 Questionnaire

G12. What kind of business, industry or service was this?

(Give full description: e.g. federal government, canning industry, forestry services)

Don't know x 0
 Refused r 0

G13. What kind of work were you doing?

(Give a full description: e.g. office clerk, factory worker, forestry technician)

Enter 1 if same kind of work as C13 or D13 or D21 (kind of work) 1 0

Don't know x 0
 Refused r 0

G14. In that work, what were your most important activities or duties?

(Give full description: e.g. filing documents, drying vegetables, forestry examination)

Enter 1 if same duties as C14 or D14 or D22 (duties) 1 0

Don't know x 0
 Refused r 0

G15. During the past 12 months, that is from "month" 1993 to "month" 1994, for how many weeks did you work at that job or business?

(Include vacation, illness, strikes, lock-outs and maternity\paternity leave)

[_] weeks

Don't know x 0
 Refused r 0

G16. During those weeks, was the work mostly full-time or part-time?

(time frame: "month" 1993 to "month" 1994)

Full-time 1 0
 Part-time 2 0
 Other (contract, shared job, etc.) 3 0
 (specify) _____

Don't know x 0
 Refused r 0

G17. During those weeks were you mainly...

An employee working for someone else? 1 0▶▶G19b
Self-employed? 2 0
 Don't know x 0▶▶G19b
 Refused r 0▶▶G19b

G18. During those weeks, did you have any paid employees?

(time frame: "month" 1993 to "month" 1994)

Yes 1 0
 No 3 0▶▶G19d
 Don't know x 0▶▶G19b
 Refused r 0▶▶G19b

G19a. About how many employees did you have?
 (If range given, enter maximum)

[_] employees

Don't know x 0
 Refused r 0

G19b. At that job, did you supervise the work of other employees?

(time frame: "month" 1993 to "month" 1994)

Yes 1 0
 No 3 0▶▶G19d
 Don't know x 0▶▶G19d
 Refused r 0▶▶G19d

GSS Cycle 9 Questionnaire

G19c. How many people did you supervise directly?

□□□□ employees

Don't know x 0
 Refused r 0

G19d. Were you a union member at that job?
 (time frame: "month" 1993 to "month" 1994)

Yes 1 0▶▶▶G19f
 No 3 0
 Don't know x 0
 Refused r 0

G19e. Were you normally covered by a union contract or collective agreement?

Yes 1 0
 No 3 0
 Don't know x 0
 Refused r 0

G19f. How closely is your job related to your education?
 Is it...

closely related? 1 0
 somewhat related? 2 0
 not related at all? 3 0
 Don't know x 0
 Refused r 0

G20. Last week, was your main activity looking for a job, going to school, keeping house, retired or something else?

(Enter one only)
 (Note: If sickness or short-term illness is reported, ask for usual major activity)

Looking for a job 2 0▶▶▶J1
 Going to school 3 0▶▶▶J7
 Keeping house 4 0▶▶▶J4
 Retired 5 0▶▶▶K1
 Something else:
 Maternity/paternity leave 6 0
 Long term illness 7 0
 Other 8 0
 (specify) _____

Don't know x 0
 Refused r 0

Go to J7.

FOR INFORMATION ONLY

GSS Cycle 9 Questionnaire

SECTION H: EMPLOYED

H1. Last week, did you have more than one job?

- Yes ... 1 0>>>H4
No ... 3 0
Don't know ... x 0>>>H4
Refused ... r 0>>>H4

H2. How many hours per week do you usually work at your job?

- [] [] hours
Don't know ... x 0>>>H8
Refused ... r 0>>>H8

Go to H5

H4. How many hours per week do you usually work at:

a) the job for which you spent the most hours

[] [] hours

b) other jobs?

[] [] hours

- Don't know ... x 0>>>H7
Refused ... r 0>>>H7

If total in H2 or H4 is 30 or more hours, go to H7, otherwise continue with H6

H6. Why do you usually work less than 30 hours per week?

(Enter maximum of 3 reasons)

- Own illness or disability ... 1 0
Personal or family responsibilities ... 2 0
Going to school ... 3 0
Could only find part-time work ... 4 0
Did not want full-time work ... 5 0
Full-time work under 30 hours per week ... 6 0
Other ... 7 0
(Specify)
Don't know ... x 0
Refused ... r 0

Read instructions for respondents with more than one job: The following questions relate to the job for which you spent the most hours last week.

H8. Last week, were you mainly ...

- An employee working for someone else? ... 1 0>>>H11
Self-employed? ... 2 0
Don't know ... x 0
Refused ... r 0

H9. Last week, did you have any paid employees?

- Yes ... 1 0
No ... 3 0>>>H11
Don't know ... x 0>>>H11
Refused ... r 0>>>H11

H10. About how many employees did you have? (If range given, enter maximum)

- [] [] [] [] employees
Don't know ... x 0
Refused ... r 0

GSS Cycle 9 Questionnaire

H11. For whom did you work last week?
 (Name of business, government department or agency, or person)
 Enter 1 if same employer as C9 or C11 or D8 or D11 or D19 0¹▶▶H13
 (Employer's name)

Don't know x 0
 Refused r 0

H12. What kind of business, industry or service was this?
 (Give full description: e.g. federal government, canning industry, forestry services)

Don't know x 0
 Refused r 0

H13. What kind of work were you doing?
 (Give a full description: e.g. office clerk, factory worker, forestry technician)
 Enter 1 if same kind of work as C13 or D13 or D21 (kind of work) 1 0

Don't know x 0
 Refused r 0

H14. In that work, what were your most important activities or duties?

(Give full description: e.g. filing documents, drying vegetables, forestry examiner)
 Enter 1 if same duties as C14, D14 or D22 (duties) 1 0

Don't know x 0
 Refused r 0

H14A. What language do you use most often at work?
 (Accept multiple responses only if languages are spoken equally)

English 1 0
 French 2 0
 Other 3 0
 (specify) _____

Don't know x 0
 Refused r 0

H15. Which of the following best describes the hours you usually work at your current job?

A regular daytime schedule or shift? 1 0

A regular evening shift? 2 0

A regular night shift? 3 0

A rotating shift?
 (one that changes periodically from days to evenings to /or nights) 4 0

A split shift? (one consisting of two or more distinct periods each day) 5 0

Other? 6 0

(Specify) _____

Don't know x 0
 Refused r 0

GSS Cycle 9 Questionnaire

H16. Do you have a flexible schedule that allows you to choose the time you begin and end your work day?

- Yes 1 0
- No 3 0
- Don't know x 0
- Refused r 0

H17. Excluding overtime, do you usually work any of your scheduled hours at home?

- Yes 1 0
- No 3 0
- Don't know x 0
- Refused r 0

**H18. Do you...
a) have a compressed work week?**

- Yes 1 0
- No 3 0
- Don't know x 0
- Refused r 0

b) do "on call" work?

- Yes 1 0
- No 3 0
- Don't know x 0
- Refused r 0

H19. In what year did you start working for this business/ company?

- ____
- Don't know x 0
 - Refused r 0

H20. For how many years have you performed the same functions?

- Less than a year 0 0
- ____ years
- Don't know x 0
 - Refused r 0

H21. During the last 12 months, how many weeks have you worked at your job?

(Include vacation, illness, strikes, lock-outs and maternity/paternity leave)

____ weeks

- Don't know x 0
- Refused r 0

If respondent is self-employed (H8), go to H24.

H23. Is your job permanent? That is, a job without a specific end date.

- Yes 1 0
- No 3 0 ▶▶H33
- Don't know x 0
- Refused r 0

H24. Last week, did you supervise the work of other employees?

- Yes 1 0
- No 3 0 ▶▶H27
- Don't know x 0 ▶▶H27
- Refused r 0 ▶▶H27

H25. How many people did you supervise directly?

____ employees

- Don't know x 0
- Refused r 0

H26. How much of your working time do you spend supervising others? Would you say...

- less than 25%? 1 0
- between 25% and 50%? 2 0
- more than 50%? 3 0
- Don't know x 0
- Refused r 0

GSS Cycle 9 Questionnaire

H27. Would you describe your job as managerial?

Yes 1 0
 No 3 0▶▶▶H31
 Don't know x 0▶▶▶H31
 Refused r 0▶▶▶H31

H28. Would you describe your work as top, upper, middle or lower management?

Top 1 0
 Upper 2 0
 Middle 3 0
 Lower 4 0
 Don't know x 0
 Refused r 0

H29. Do you take part in planning the activities of...

**the entire business/
 company?** 1 0
only a part of it? 2 0
 not involved in planning 3 0▶▶▶H31
 Don't know x 0▶▶▶H31
 Refused r 0▶▶▶H31

H30. How much of your working time do you spend on planning the activities of your company? Is it....

less than 25%? 1 0
between 25% and 50%? 2 0
more than 50%? 3 0
 Don't know x 0
 Refused r 0

H31. In total, about how many people work in your business/ company at all its locations?

Less than 20 1 0
 Between 20 and 99 2 0
 Between 100 and 249 3 0
 Between 250 and 499 4 0
 Between 500 and 999 5 0
 1,000 or more employees 6 0
 Don't know x 0
 Refused r 0

Go to H42a

H33. Would you prefer to have a permanent job?

Yes 1 0
 No 3 0
 Don't know x 0
 Refused r 0

H34. Last week, did you supervise the work of other employees?

Yes 1 0
 No 3 0▶▶▶H37
 Don't know x 0▶▶▶H37
 Refused r 0▶▶▶H37

H35. How many people did you supervise directly?

| | | | | employees
 Don't know x 0
 Refused r 0

H36. How much of your working time do you spend supervising others? Would you say...

less than 25% ? 1 0
between 25% and 50%? 2 0
more than 50% 3 0
 Don't know x 0
 Refused r 0

H37. Would you describe your job as managerial?

Yes 1 0
 No 3 0▶▶▶H41
 Don't know x 0▶▶▶H41
 Refused r 0▶▶▶H41

GSS Cycle 9 Questionnaire

H38. Would you describe your work as top, upper, middle or lower management?

- Top 1 0
- Upper 2 0
- Middle 3 0
- Lower 4 0
- Don't know x 0
- Refused r 0

H39. Do you take part in planning the activities of...

- the entire business/
company?** 1 0
- only a part of it?** 2 0
- not involved in planning 3 0▶▶▶H41
- Don't know 4 0▶▶▶H41
- Refused 5 0▶▶▶H41

H40. How much of your working time do you spend on planning activities of your company? Is it...

- less than 25% ?** 1 0
- between 25% and 50%?** 2 0
- more than a half?** 3 0
- Don't know x 0
- Refused r 0

**H41. In total, how many people work in your business/
company at all its locations?**

- Less than 20 1 0
- Between 20 and 99 2 0
- Between 100 and 249 3 0
- Between 250 and 499 4 0
- Between 500 and 999 5 0
- 1,000 or more employees 6 0
- Don't know x 0
- Refused r 0

H42a. Are you a union member at work?

- Yes 1 0▶▶▶H43
- No 3 0
- Don't know x 0
- Refused r 0

H42b. Are you normally covered by a contract or a collective agreement?

- Yes 1 0
- No 3 0
- Don't know x 0
- Refused r 0

H43. Does your business or company provide you with a...

a) Retirement pension plan (in addition to the Canada Pension Plan or Quebec Pension Plan contribution required of employers)?

- Yes 1 0
- No 3 0
- Don't know x 0
- Refused r 0

b) Medical/surgical benefits beyond those provided by your provincial health care system?

- Yes 1 0
- No 3 0
- Don't know x 0
- Refused r 0

c) Dental Care Benefits?

- Yes 1 0
- No 3 0
- Don't know x 0
- Refused r 0

d) Counselling or referral services for personal problems?

- Yes 1 0
- No 3 0
- Don't know x 0
- Refused r 0

e) Drug benefit plan?

- Yes 1 0
- No 3 0
- Don't know x 0
- Refused r 0

GSS Cycle 9 Questionnaire

f) Paid maternity or paternity leave, in addition to the benefits provided by Unemployment Insurance?

- Yes 1 0
- No 3 0
- Don't know x 0
- Refused r 0

H44. Have any of the following things in your work environment caused you excess worry or stress in the past 12 months...

(a) Too many demands or too many hours?

- Yes 1 0
- No 3 0
- Don't know x 0
- Refused r 0

(b) Risk of accident or injury?

- Yes 1 0
- No 3 0
- Don't know x 0
- Refused r 0

© Poor interpersonal relations?

- Yes 1 0
- No 3 0
- Don't know x 0
- Refused r 0

(d) Threat of layoff or job loss?

- Yes 1 0
- No 3 0
- Don't know x 0
- Refused r 0

(e) Anything else?

- Yes 1 0
(specify)
- No 3 0
- Don't know x 0
- Refused r 0

H45. Do you agree or disagree with the following statements?

(a) Your job requires a high level of skill.

- Agree 1 0
- Disagree 2 0

Is that somewhat or strongly?

- Somewhat 1 0
- Strongly 2 0
- Don't know x 0
- Refused r 0

(b) There is a lot of freedom to decide how to do your work.

- Agree 1 0
- Disagree 2 0

Is that somewhat or strongly?

- Somewhat 1 0
- Strongly 2 0
- Don't know x 0
- Refused r 0

© The people you work with take a personal interest in you.

- Agree 1 0
- Disagree 2 0

Is that somewhat or strongly?

- Somewhat 1 0
- Strongly 2 0
- Not applicable 3 0
- Don't know x 0
- Refused r 0

(d) Your supervisor is very concerned about the welfare of those under (him/her).

- Agree 1 0
- Disagree 2 0

Is that somewhat or strongly?

- Somewhat 1 0
- Strongly 2 0
- Not applicable 3 0
- Don't know x 0
- Refused r 0

GSS Cycle 9 Questionnaire

H46. Do you use computers such as mainframes, personal computers or word processors in your job?

- Yes 1 0
- No 3 0▶▶H48
- Don't know x 0▶▶H48
- Refused r 0▶▶H48

H47. How many hours per week do you normally use this equipment?

(Include work done at home for job)

□□□ hours

- Don't know x 0
- Refused r 0

H48. In the last five years, how much has your work been affected by the introduction of computers or automated technology? Would you say...

- greatly? 1 0
- somewhat? 2 0
- hardly? 3 0▶▶H52
- not at all? 4 0▶▶H52
- Don't know x 0▶▶H52
- Refused r 0▶▶H52

H49. In the last five years, has the level of skill required to perform your work increased, decreased, or stayed the same as a result of the introduction of computers or automated technology?

- Increased 1 0
- Decreased 2 0
- Stayed the same 3 0
- Don't know x 0
- Refused r 0

H50. In the last five years, has the job security increased, decreased, or stayed the same as a result of the introduction of computers or automated technology?

- Increased 1 0
- Decreased 2 0
- Stayed the same 3 0
- Don't know x 0
- Refused r 0

H51. Over the last five years, has your work become more interesting, less interesting, or stayed the same as a result of the introduction of computers or automated technology?

- More interesting 1 0
- Less interesting 2 0
- Stayed the same 3 0
- Don't know x 0
- Refused r 0

H52. How closely is your job related to your education? Is it ...

- closely related? 1 0
- somewhat related? 2 0
- not related at all? 3 0
- Don't know x 0
- Refused r 0

H53. Considering your experience, education and training, do you feel that you are overqualified for your job?

- Yes 1 0
- No 3 0
- Don't know x 0
- Refused r 0

H54. Do you think it is likely you will lose your job or be laid off in the next year? Would you say it is...

- Very likely? 1 0
- Somewhat likely? 2 0
- Somewhat unlikely? 3 0▶▶H56
- Very unlikely? 4 0▶▶H56
- Don't know x 0▶▶H56
- Refused r 0▶▶H56

H55. Do you think this will be because of the introduction of computers or automated technology?

- Yes 1 0
- No 3 0
- Don't know x 0
- Refused r 0

H56. Now I will ask you some questions about your work activities during the last five years.

GSS Cycle 9 Questionnaire

H57. Five years ago, that is from "month" 1989 to "month" 1990, was your main activity working at a job or business, looking for work, going to school, keeping house, retired or something else?

(Enter one only)

(Note: If sickness or short-term illness is reported, ask for usual major activity.)

- Working at a job or business . . . 1 0▶▶▶H59
- Looking for work 2 0
- Going to school 3 0
- Keeping house 4 0
- Retired 5 0
- Something else:
- Maternity / paternity leave 6 0
- Long term illness 7 0
- Other 8 0
- (Specify) _____

- Don't know x 0
- Refused r 0

H58. Did you have a job or were you self-employed at any time during these 12 months?

- Yes 1 0
- No 3 0▶▶▶H65
- Don't know x 0▶▶▶H65
- Refused r 0▶▶▶H65

H59. For whom did you work the longest time during that period?

(time frame: "month" 1989 to "month" 1990) (Name of business, government department or agency, or person)

Enter 1 if same employer as in H11

(Employer's name) 1 0▶▶▶H61

- Don't know x 0
- Refused r 0

H60. What kind of business, industry or service was this?

(Give full description: e.g. federal government, canning industry, forestry services)

- Don't know x 0
- Refused r 0

H61. What kind of work were you doing?

(time frame: "month" 1989 to "month" 1990) (Give a full description: e.g. office clerk, factory worker, forestry technician)

Enter 1 if same work as in H13 (kind of work) 1 0

- Don't know x 0
- Refused r 0

H62. In that work, what were your most important activities or duties?

(Give full description: e.g. filing documents, drying vegetables, forestry examiner)

Enter 1 if same duties as in H14 (duties) 1 0

- Don't know x 0
- Refused r 0

H63a. At that time, were you mainly...

- an employee working for someone else?** 1 0
- self-employed?** 2 0
- Don't know x 0
- Refused r 0

H63b. Were you a union member at work?

(time frame: "month" 1989 to "month" 1990)

- Yes 1 0▶▶▶H63d
- No 3 0
- Don't know x 0
- Refused r 0

GSS Cycle 9 Questionnaire

H63c. Were you normally covered by a contract or a collective agreement?

- Yes 1 0
- No 3 0
- Don't know x 0
- Refused r 0

H63d. Five years ago, did you supervise the work of other employees?

(time frame: "month" 1989 to "month" 1990)

- Yes 1 0
- No 3 0▶▶▶H64
- Don't know x 0▶▶▶H64
- Refused r 0▶▶▶H64

H63e. At that time, how many people did you supervise directly?

employees

- Don't know x 0
- Refused r 0

H64. How closely was that job related to your education at that time? Was it...

- closely related? 1 0
- somewhat related? 2 0
- not related at all? 3 0
- Don't know x 0
- Refused r 0

H65. During the last five years, did you lose a job for any reason?

- Yes 1 0
- No 3 0▶▶▶H67
- Don't know x 0▶▶▶H67
- Refused r 0▶▶▶H67

H66. Why did this happen?

(Enter maximum of 3 reasons)

- An employer going out of business 1 0
 - A plant closing or moving 2 0
 - The introduction of new technology 3 0
 - Reduction of staff 4 0
 - Seasonal job 5 0
 - Shortage of work 6 0
 - Accident, illness or disability 7 0
 - Other 8 0
- (Specify) _____

- Don't know x 0
- Refused r 0

H67. During the last five years, how many different jobs or positions did you have

a) with your current employer? By different jobs or positions we mean different duties.

jobs

- Don't know x 0
- Refused r 0

b) with other employers?

jobs

- Don't know x 0
- Refused r 0

H67c. During the last five years, how many times have you received a promotion from your current business/company?(By promotion we mean obtaining a new position with more responsibilities, with or without a salary increase).

(Since started if less than five years ago).

promotions

- Don't know x 0
- Refused r 0

GSS Cycle 9 Questionnaire

H68. There were 60 months between "month" 1989 and "month" 1994. In how many of those months were you working at a job or business?

(Include vacation, illness, strikes, lock-outs and maternity/paternity leave)

60 months ¹ 0▶▶▶H70

□□□ months

Don't know ^x 0▶▶▶H70

Refused ^r 0▶▶▶H70

H69. In how many of the remaining months did you look for work?

None ¹ 0

□□□ months

Don't know ^x 0

Refused ^r 0

The next question is to be asked of people aged 50 and over that did not indicate "Retired" in G2. For those who indicated "Retired" in G2, go to H72. Otherwise, go to H87.

H71. Have you ever retired from a former employer?

Yes ¹ 0

No ³ 0▶▶▶H87

Don't know ^x 0▶▶▶H87

Refused ^r 0▶▶▶H87

H72. In which year did you retire?

□□□□

Don't know ^x 0

Refused ^r 0

H73. Did you retire because your employer had a mandatory retirement policy?

Yes ¹ 0▶▶▶H75

No ³ 0

Don't know ^x 0

Refused ^r 0

H74. Why did you retire?

(Enter maximum of 3 reasons)

Your employer offered an early retirement incentive ¹ 0

New technology was introduced ² 0

Your health required it ³ 0

You were unemployed and couldn't find a new job ⁴ 0

For any other reason ⁵ 0

(Specify) _____

Don't know ^x 0

Refused ^r 0

For information only

GSS Cycle 9 Questionnaire

H75. What is the main reason that motivated your return to the labour force after your retirement?

Don't know x 0
 Refused r 0

H76. In which year did you start your first job after this retirement?

□□□□

Don't know x 0
 Refused r 0

H77. For this job, was the work mostly full-time or part-time?

Full-time 1 0
 Part-time 2 0
 Other (contract, shared job, etc.) 3 0
 (Specify) _____

Don't know x 0
 Refused r 0

H78. Were you mainly...

An employee working for someone else? 1 0
Self-employed? 2 0
 Don't know x 0
 Refused r 0

H79. Was this job permanent, that is a job without a specific end date?

Yes 1 0▶▶H81
 No 3 0
 Don't know x 0▶▶H81
 Refused r 0▶▶H81

H80. Was it a contract for a fixed period of time?

Yes 1 0
 No 3 0
 Don't know x 0
 Refused r 0

H81. For how many months have you performed this job?

□□□ months

Don't know x 0
 Refused r 0

H82. Have you worked at other jobs since your retirement?

Yes 1 0
 No 3 0▶▶H88
 Don't know x 0▶▶H88
 Refused r 0▶▶H88

H83. How many different jobs or positions did you have since you retired? By different jobs or positions we mean different duties with the same employer, or different employers. (Including the first job after retirement.)

□□□ jobs

Don't know x 0
 Refused r 0

H84. At what age do you plan to take a permanent retirement?

□□□□ years

Don't intend to retire 0 0
 Don't know x 0
 Refused r 0

GSS Cycle 9 Questionnaire

H85. Do you think that mandatory retirement is a good idea?

- Yes 1 0
- ▶▶▶ At what age?
- No 3 0
- Don't know x 0
- Refused r 0

Go to H90

H87. Now some questions about your retirement plans.

H88. At what age do you plan to retire?

- years
- Don't intend to retire 0 0
 - Don't know x 0
 - Refused r 0

H89. Do you think that mandatory retirement is a good idea?

- Yes 1 0
- ▶▶▶ At what age?
- No 3 0
- Don't know x 0
- Refused r 0

For those who worked at any time during the last five years (H68 = 1) go to Section L, otherwise go to Section M.

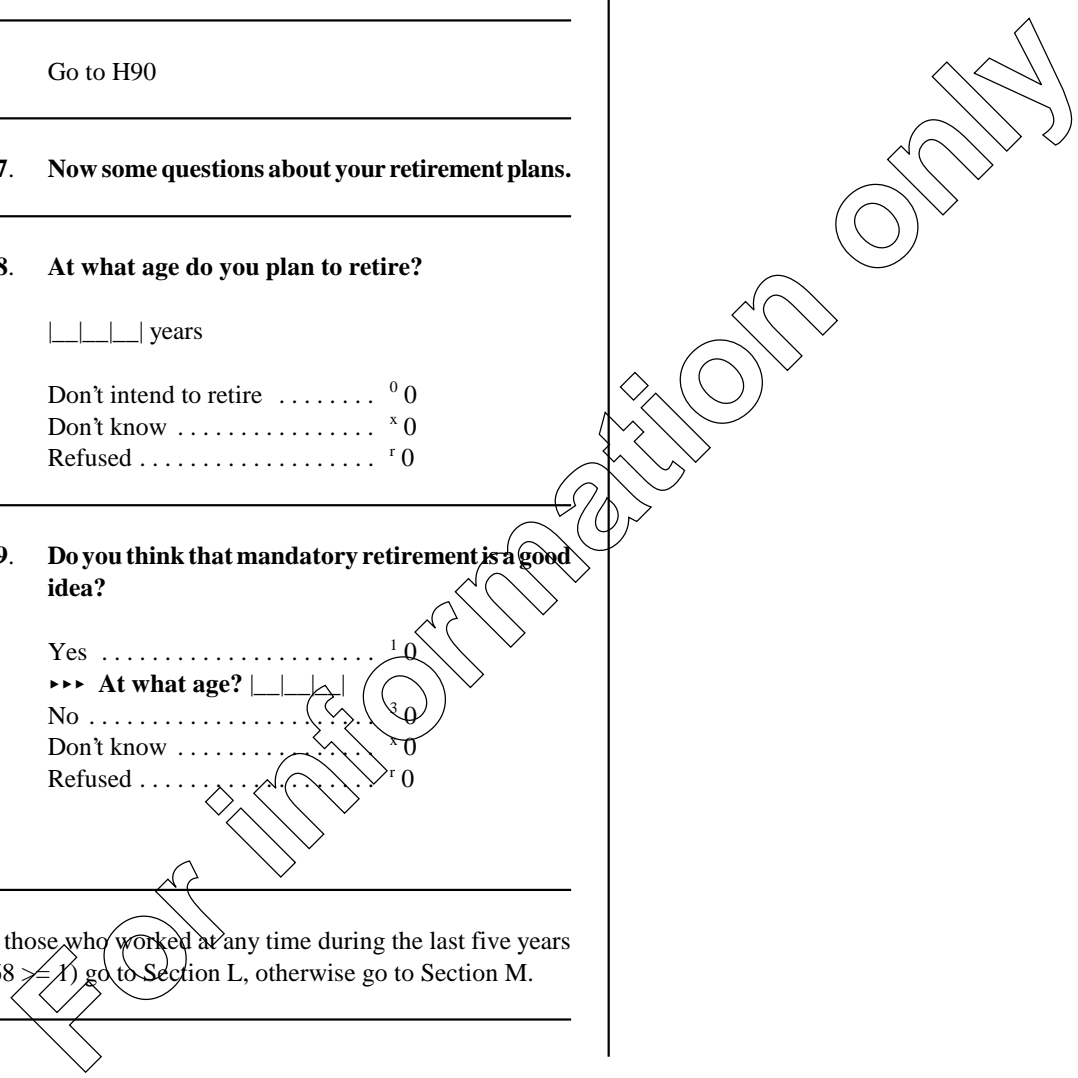

GSS Cycle 9 Questionnaire

SECTION J: PERSONS NOT EMPLOYED

J1. Were you mainly looking for a full-time or a part-time job?

- Full-time 1 0
- Part-time 2 0
- Either 3 0
- Don't know x 0
- Refused r 0

J2. In your opinion, what are the chances that you will find a job in the next six months? Are they.

- Very good? 1 0
- Good? 2 0
- Not good? 3 0
- Not very good? 4 0
- Has already found work 5 0
- Don't know x 0
- Refused r 0

Go to J7.

J4. Are you satisfied or dissatisfied to be keeping house as your main activity?

- Satisfied 1 0 ▶▶ J4a
- Dissatisfied 2 0 ▶▶ J4a
- No opinion x 0 ▶▶ J5
- Refused r 0 ▶▶ J5

J4A. Is that somewhat or very?

- Somewhat 1 0
- Very 2 0
- Don't know x 0
- Refused r 0

J5. Would you like to have a paying job now?

- Yes 1 0
- No 3 0 ▶▶ J7
- Don't know x 0
- Refused r 0 ▶▶ J7

J6. For what reason do you not have a paying job?
(Enter maximum of 3 reasons)

- Jobs are unavailable or hard to find 1 0
- You lack skills or qualifications 2 0
- Own illness or disability 3 0
- Unable to find good child-care 4 0
- You prefer to stay home with children 5 0
- Your spouse wants you to stay home 6 0
- Because of personal or family responsibilities 7 0
- Any other reasons (specify) 8 0
- Don't know x 0
- Refused r 0

J7. Now I will ask you some questions about your work activities during the last five years.

GSS Cycle 9 Questionnaire

J8. Five years ago, that is from "month" 1989 to "month" 1990, was your main activity working at a job or business, looking for work, going to school, keeping house, retired or something else?

(Enter one only)

(Note: If sickness or short-term illness is reported, ask for usual major activity)

- Working at a job or business . . . ¹ 0▶▶▶J13
- Looking for work ² 0
- Going to school ³ 0
- Keeping house ⁴ 0
- Retired ⁵ 0

Something else:

- Maternity/ paternity leave ⁶ 0
 - Long term illness ⁷ 0
 - Other ⁸ 0
- (specify) _____

- Don't know ^x 0
- Refused ^r 0

If C6= "has never worked before", go to J24 and then to J41

J9. Did you have a job or were you self-employed at any time during these twelve months?

(time frame: "month" 1989 to "month" 1990)

- Yes ¹ 0▶▶▶J13
- No ³ 0
- Don't know ^x 0
- Refused ^r 0

J10. Did you have a job or were you self-employed at any time during the last five years?

- Yes ¹ 0▶▶▶J17
- No ³ 0
- Don't know ^x 0
- Refused ^r 0

J11. Did you look for work in any month during the last five years?

- Yes ¹ 0
- No ³ 0▶▶▶J24
- Don't know ^x 0▶▶▶J24
- Refused ^r 0▶▶▶J24

J12. There were 60 months between "month" 1989 and "month" 1994. In how many of those months did you look for work?

□□□ months

- Don't know ^x 0
- Refused ^r 0

Go to J24.

J13. For whom did you work the longest time during that period?

(Name of business, government department or agency, or person)

(time frame: "month" 1989 to "month" 1990)

Enter 1 if same employer as in G11

(Employer's name) ¹ 0▶▶J15

- Don't know ^x 0
- Refused ^r 0

J14. What kind of business, industry or service was this?

(Give full description: e.g. federal government, canning industry, forestry services)

- Don't know ^x 0
- Refused ^r 0

GSS Cycle 9 Questionnaire

J15. What kind of work were you doing?
 (Give a full description: e.g. office clerk, factory worker, forestry technician)
 (time frame: "month" 1989 to "month" 1990)
 Enter 1 if same work as in G13
 (Kind of work) 1 0

Don't know x 0
 Refused r 0

J16a. In that work, what were your most important activities or duties?
 (Give full description: e.g. filing documents, drying vegetables, forestry examiner)
 Enter 1 if same duties as in G14 (duties) 1 0

Don't know x 0
 Refused r 0

J16b. At that time, were you mainly...

an employee working for someone else? 1 0
self-employed? 2 0

Don't know x 0
 Refused r 0

J16c. Were you a union member at work? (time frame: month " 1989 to "month" 1990)

Yes 1 0 ▶▶▶ J16e
 No 3 0
 Don't know x 0
 Refused r 0

J16d. Were you normally covered by a contract or a collective agreement?

Yes 1 0
 No 3 0
 Don't know x 0
 Refused r 0

J16e. Five years ago, did you supervise the work of other employees?
 (time frame: "month" 1989 to "month" 1990)

Yes 1 0
 No 3 0 ▶▶▶ J17
 Don't know x 0 ▶▶▶ J17
 Refused r 0 ▶▶▶ J17

J16f. At that time, how many people did you supervise directly?

□□□□ employees

Don't know x 0
 Refused r 0

J17. How closely was that job related to your education at that time? Was it...

closely related? 1 0
somewhat related? 2 0
not related at all? 3 0
 Don't know x 0
 Refused r 0

J18. Considering your experience, education and training, do you feel that you have been overqualified for most of your jobs?

Yes 1 0
 No 3 0
 Don't know x 0
 Refused r 0

GSS Cycle 9 Questionnaire

J19. During the last five years, did you lose a job for any reason?

- Yes ¹ 0
- No ³ 0▶▶▶J21
- Don't know ^x 0▶▶▶J21
- Refused ^r 0▶▶▶J21

J20. Why did this happen?

(Enter maximum of 3 reasons)

- An employer going out of business ¹ 0
 - A plant closing or moving ² 0
 - The introduction of new technology ³ 0
 - Reduction of staff ⁴ 0
 - Seasonal job ⁵ 0
 - Shortage of work ⁶ 0
 - Own illness, disability or accident ⁷ 0
 - Other ⁸ 0
- (specify) _____

- Don't know ^x 0
- Refused ^r 0

J21. During the last five years, how many different jobs or positions did you have? (By different jobs or positions we mean different duties with the same employer, or different employers.)

||| jobs

- Don't know ^x 0
- Refused ^r 0

J22. There were 60 months between "month" 1989 and "month" 1994. In how many of those months were you working at a job or business?

(Include vacation, illness, strikes, lock-outs and maternity/ paternity leave)

60 months 0▶▶▶J24

||| months

- Don't know ^x 0▶▶▶J24
- Refused ^r 0▶▶▶J24

J23. In how many of the remaining months did you look for work?

||| months

- Don't know ^x 0
- Refused ^r 0

J24. Do you intend to work at a job in the future?

- Yes ¹ 0
- No ³ 0
- Don't know ^x 0
- Refused ^r 0

The next question is to be asked of people aged 50 and over that did not indicate "Retired" in G2. For those who indicated "Retired" in G2 go to J26: Otherwise, go to J40.

J25. Have you ever retired from a former employer?

- Yes ¹ 0
- No ³ 0▶▶▶J40
- Don't know ^x 0▶▶▶J40
- Refused ^r 0▶▶▶J40

J26. In which year did you retire?

(if the respondent has retired more than once, indicate the first retirement date).

|||||

- Don't know ^x 0
- Refused ^r 0

J27. Did you retire because your employer had a mandatory retirement policy?

- Yes ¹ 0▶▶▶J28a
- No ³ 0
- Don't know ^x 0
- Refused ^r 0

GSS Cycle 9 Questionnaire

J28. Why did you retire?
(Enter maximum of 3 reasons)

Your employer offered an early retirement incentive ¹ 0

New technology was introduced ² 0

Your health required it ³ 0

You were unemployed and couldn't find a new job ^x 0

For any other reason ^r 0
(specify) _____

Don't know ^x 0

Refused ^r 0

J28A. Did you work at a job or business at any time after your retirement?

Yes ¹ 0

No ³ 0▶▶▶J42

Don't know ^x 0▶▶▶J42

Refused ^r 0▶▶▶J42

J29. What is the main reason that motivated your return to the labour force after your retirement?

Don't know ^x 0

Refused ^r 0

J30. In which year did you start your first job after this retirement?

□□□□

Don't know ^x 0

Refused ^r 0

J31. For this job, was the work mostly full-time or part-time?

Full-time ¹ 0

Part-time ² 0

Other (contract, shared job, etc.) ³ 0
(specify) _____

Don't know ^x 0

Refused ^r 0

J32. Were you mainly... an employee working for someone else? self-employed?

an employee working for someone else? ¹ 0

self-employed? ² 0

Don't know ^x 0

Refused ^r 0

J33. Was this job permanent? That is, a job without a specific end date.

Yes ¹ 0▶▶▶J35

No ³ 0

Don't know ^x 0

Refused ^r 0

J34. Was it a contract for a fixed period of time?

Yes ¹ 0

No ³ 0

Don't know ^x 0

Refused ^r 0

J35. For how many months have you performed this job?

□□□□ months

Don't know ^x 0

Refused ^r 0

GSS Cycle 9 Questionnaire

J36. Have you worked at other jobs since your retirement?

- Yes ¹ 0
- No ³ 0▶▶▶J38
- Don't know ^x 0▶▶▶J38
- Refused ^r 0▶▶▶J38

J37. How many different jobs or positions did you have since you retired? By different jobs or positions we mean different duties with the same employer, or different employers.

(Including the first job after retirement)

||| jobs

- Don't know ^x 0
- Refused ^r 0

J38. At what age do you plan to take a permanent retirement?

||| years

- Don't intend to retire ⁰ 0
- Don't know ^x 0
- Refused ^r 0

Go to J43

J39. Do you think that mandatory retirement is a good idea?

- Yes ¹ 0
- ▶▶▶ At what age? |||
- No ³ 0
- Don't know ^x 0
- Refused ^r 0

J40. Now some questions about your retirement plans.

J41. At what age do you plan to retire?

||| years

- Don't intend to retire ⁰ 0
- Don't know ^x 0
- Refused ^r 0

J42. Do you think that mandatory retirement is a good idea?

- Yes ¹ 0
- ▶▶▶ At what age? |||
- No ³ 0
- Don't know ^x 0
- Refused ^r 0

J43. For those who worked at any time during the last five years (J21 >= 1) go to Section L, otherwise go to Section M.

GSS Cycle 9 Questionnaire

SECTION K: RETIRED

K1. The following questions pertain to your activities before and after your retirement.

K2. In what year did you retire?
(If the respondent has retired more than once, indicate the date of the FIRST RETIREMENT).

□□□□

Don't know x 0
Refused r 0

K3. Just before your retirement, were you working at a job or business?

Yes 1 0
No 3 0▶▶K11
Don't know x 0▶▶K11
Refused r 0▶▶K11

K4. Was the work mostly full-time or part-time?

Full-time 1 0
Part-time 2 0
Other (contract, shared job, etc.) 3 0
(specify) _____
Don't know x 0
Refused r 0

K5. Were you mainly then...

an employee working for someone else 1 0
self-employed? 2 0
Don't know x 0
Refused r 0

K6. For whom were you working just before you retired?

(Name of business, government department or agency, or person)

Don't know x 0
Refused r 0

K7. What kind of business, industry or service was this?

(Give full description: e.g. federal government, canning industry, forestry services)

Don't know x 0
Refused r 0

K8. What kind of work were you doing?

(Give a full description: e.g. office clerk, factory worker, forestry technician)

Don't know x 0
Refused r 0

K9. In that work, what were your most important activities or duties?

(Give full description: e.g. filing documents, drying vegetables, forestry examiner)

Don't know x 0
Refused r 0

GSS Cycle 9 Questionnaire

K10. How closely was that job related to your education at that time? Was it...

- closely related? 1 0
- somewhat related? 2 0
- Not related at all? 3 0
- Don't know x 0
- Refused r 0

K11. Did you retire because your employer had a mandatory retirement policy?

- Yes 1 0▶▶▶K13
- No 3 0
- Don't know x 0
- Refused r 0

K12. Why did you retire?

(Enter maximum of 3 reasons)

- Your employer offered an early retirement incentive 1 0
- New technology was introduced 2 0
- Your health required it 3 0
- You were unemployed and could not find a job 4 0
- For another reason 5 0
(specify) _____
- Don't know x 0
- Refused r 0

K13. Do you receive a pension or retirement benefits from any of your former employers?

- Yes 1 0
- No 3 0▶▶▶K15
- Don't know x 0▶▶▶K15
- Refused r 0▶▶▶K15

K14. Are these benefits adjusted for changes in the cost of living?

- Yes 1 0
- No 3 0
- Don't know x 0
- Refused r 0

K15. Compared to the year before you retired, do you now enjoy life more, less or about the same?

- More 1 0
- Less 2 0▶▶▶K18
- About the same 3 0▶▶▶K19
- Don't know x 0▶▶▶K19
- Refused r 0▶▶▶K19

K16. What is the main reason that you now enjoy life more? Is it.

(Enter one only)

- More leisure time? 1 0
- More travel? 2 0
- More time with family? 3 0
- More time for voluntary activities? 4 0
- Other? 5 0
(specify) _____

- Don't know x 0
- Refused r 0

Go to K19.

K18. What is the main reason that you now enjoy life less? Is it...

(Enter one only)

- your health? 1 0
- a decrease in income? 2 0
- less contact with people? 3 0
- other 4 0
(specify) _____
- Don't know x 0
- Refused r 0

GSS Cycle 9 Questionnaire

K19. Do you think mandatory retirement is a good idea?

- Yes 1 0
 >>> At what age? [][][][]
 No 3 0
 Don't know x 0
 Refused r 0

K20. Now I will ask you some questions about your work activities during the last five years.

K21. Five years ago, that is from "month" 1989 to "month" 1990, was your main activity working at a job or business, looking for work, going to school, keeping house, retired or something else?
 (Enter one only)

(Note: If sickness or short-term illness is reported, ask for usual major activity)

- Working at a job or business .. 1 0>>>K27
 Looking for work 2 0
 Going to school 3 0
 Keeping house 4 0
 Retired 5 0
 Something else
 Maternity/paternity leave 6 0
 Long term illness 7 0
 Other 8 0
 (specify) _____
 Don't know x 0
 Refused r 0

K22. Did you have a job or were you self-employed at any time during these 12 months?

- Yes 1 0>>>K27
 No 3 0
 Don't know x 0
 Refused r 0

K23. During the last five years, did you have a job or were you self-employed at any time?

- Yes 1 0>>>K31.
 No 3 0
 Don't know x 0
 Refused r 0

If "Retired" in K21, go to K36.

K24. Did you look for work in any month during these five years?

- Yes 1 0
 No 3 0>>>M1
 Don't know x 0>>>M1
 Refused r 0>>>M1

K25. There were 60 months between "month" 1989 and "month" 1994. In how many of those months did you look for work?

- [][] months
 Don't know x 0
 Refused r 0

Go to M1.

K27. For whom did you work the longest time during that period?

(Name of business, government department or agency, or person)
 (time frame: "month" 1989 to "month" 1990)
 Enter 1 if employer is same as in K6
 (employer's name) 1 0>>>K29

- Don't know x 0
 Refused r 0

GSS Cycle 9 Questionnaire

K28. What kind of business, industry or service was this?

(Give full description: e.g. federal department, canning industry, forestry services)

Don't know x 0
 Refused r 0

K29. What kind of work were you doing?

(Give a full description: e.g. office clerk, factory worker, forestry technician)

(time frame: "month" 1989 to "month" 1990)

Enter 1 if employer is same as in K8

(kind of work) 1 0

Don't know x 0
 Refused r 0

K30a. In that work, what were your most important activities or duties?

(Give full description: e.g. filing document, drying vegetables, forestry examiner)

Enter 1 if employer is same as in K9

(duties) 1 0

Don't know x 0
 Refused r 0

K30b. At that time, were you mainly...

an employee working for someone else? 1 0

self-employed? 2 0

Don't know x 0

Refused r 0

K30c. Five years ago, did you supervise the work of other employees?

(time frame: "month" 1989 to "month" 1990)

Yes 1 0
 No 3 0▶▶▶K30e
 Don't know x 0▶▶▶K30e
 Refused r 0▶▶▶K30e

K30d. At that time, how many people did you supervise directly?

□□□□ employees

Don't know x 0
 Refused r 0

K30e. Were you a union member at work? (time frame: "month" 1989 to "month" 1990)

Yes 1 0▶▶▶K31
 No 3 0
 Don't know x 0
 Refused r 0

K30f. Were you normally covered by a contract or a collective agreement?

Yes 1 0
 No 3 0
 Don't know x 0
 Refused r 0

K31. Other than the job you retired from, did you lose a job between "month" 1989 and "month" 1994 for any reason?

Yes 1 0
 No 3 0▶▶▶K33
 Don't know x 0▶▶▶K33
 Refused r 0▶▶▶K33

GSS Cycle 9 Questionnaire

K32. Why did this happen?

(Enter maximum of 3 reasons)

- An employer going out of business ¹ 0
- A plant closing or moving ² 0
- The introduction of new technology ³ 0
- Reduction of staff ⁴ 0
- Seasonal job ⁵ 0
- Shortage of work ⁶ 0
- Own illness, disability or accident ⁷ 0
- Other ⁸ 0
(specify) _____
- Don't know ^x 0
- Refused ^r 0

K33. During the last five years, how many different jobs or positions did you have? By different jobs or positions we mean different duties with the same employer, or different employers.

□□ jobs

- Don't know ^x 0
- Refused ^r 0

K34. There were 60 months between "month" 1989 and "month" 1994. In how many of those months were you working at a job or business?

(Include vacation, illness, strikes, lock-outs and maternity/paternity leave)

60 months 0▶▶▶K37

□□ months

- Don't know ^x 0▶▶▶K37
- Refused ^r 0▶▶▶K37

K35. In how many of the remaining months did you look for work?

None ⁰ 0

□□ months

- Don't know ^x 0
- Refused ^r 0

K37. Did you work at any time at a job or business after your retirement?

- Yes ¹ 0▶▶▶K39
- No ³ 0
- Don't know ^x 0
- Refused ^r 0

K38. Did you look for work at any time after your retirement?

- Yes ¹ 0▶▶▶K41
- No ³ 0▶▶▶K51
- Don't know ^x 0▶▶▶K51
- Refused ^r 0▶▶▶K51

K39. What is the MAIN REASON that motivated your return to the labour force after your retirement?

- Don't know ^x 0
- Refused ^r 0

Go to K43.

K41. What is the MAIN REASON you looked for work after you retired?

- Don't know ^x 0
- Refused ^r 0

Go to K51.

GSS Cycle 9 Questionnaire

K43. In what year did you start your first job after retirement?

|||||

Don't know x 0
 Refused r 0

K44. Was the work mostly full-time or part-time?

Full-time 1 0
 Part-time 2 0
 Other (contract, shared job,
 etc.) 3 0
 (specify) _____

Don't know x 0
 Refused r 0

**K45. Were you mainly then...
 an employee working for
 someone else ?**

..... 1 0
self-employed? 2 0
 Don't know x 0
 Refused r 0

**K46. Was that job permanent? That is a job without a
 specific end date.**

Yes 1 0 → K48
 No 2 0
 Don't know x 0
 Refused r 0

K47. Was it a contract for a fixed period of time?

Yes 1 0
 No 3 0
 Don't know x 0
 Refused r 0

**K48. For how many months have you performed that
 job?**

||| months

Don't know x 0
 Refused r 0

**K49. Have you worked at other jobs since your
 retirement?**

Yes 1 0
 No 3 0 → K51
 Don't know x 0 → K51
 Refused r 0 → K51

**K50. How many different jobs or positions did you
 have after your retirement? By different jobs
 or positions we mean different duties with the
 same employer, or different employers.**

||| jobs

Don't know x 0
 Refused r 0

For those who worked at any time during the
 last five years (K33 >= 1) go to Section L,
 otherwise go to Section M.

SECTION L: WORK INTERRUPTIONS

L1. The following questions are about work interruptions for persons working full-time or part time or for those who have, at one time, worked full-time or part time.

Note: Summer jobs and coop programs are not to be considered in this section on work interruptions.

L2. During the last five years, that is since "month" 1989, did you leave your job, or were you ever away from work, for a period of three or more months?

- Yes ¹ 0
- No ³ 0▶▶M1
- Don't know ^x 0▶▶M1
- Refused ^r 0▶▶M1

L3. During those five years, how many times have you been away from work for a period of three or more months?

||| times

- Don't know ^x 0
- Refused ^r 0▶▶M1

If the number given in L3 is greater than or equal to 5 then ask the next question, else go to L7.

L5. Is it because you held a seasonal job?

- Yes ¹ 0
- No ³ 0▶▶L7
- Don't know ^x 0▶▶L7
- Refused ^r 0▶▶L7

L6. Were there any other work interruptions for three months or longer not related to a seasonal job?

- Yes ¹ 0
- No ³ 0▶▶M1
- Don't know ^x 0▶▶M1
- Refused ^r 0▶▶M1

L7. I am now going to ask you some questions about each of these work interruptions, STARTING WITH THE MOST RECENT ONE.

MOST RECENT INTERRUPTION:

L8. In what year did your most recent work interruption begin?

|||||

- Don't know ^x 0
- Refused ^r 0

L9. At that time were you working mostly full-time or part-time?

- Full-time ¹ 0
- Part-time ² 0
- Other (contract, shared job, etc) ³ 0
- (specify) _____

- Don't know ^x 0
- Refused ^r 0

GSS Cycle 9 Questionnaire

L10. What were the reasons you were away from work?

(Enter maximum of 3 reasons)

- Own illness, disability or accident 01 0
- Temporary layoff/End of contract 02 0
- Lack of work 03 0
- Business or company closure 04 0
- Maternity/paternity leave 05 0
- Child care 06 0
- Care of the elderly 07 0
- Personal or family responsibilities (other than child care and elder care) 08 0
- Returned to school 09 0
- Retired 10 0 ▶▶▶L13
- Other 11 0
(specify) _____
- Don't know x 0
- Refused r 0

L11. For how long were you away from work before you returned to work on a regular basis, either full-time or part-time?

[[]] months

- Has Not worked since 0 0 ▶▶▶L13
- Don't know x 0
- Refused r 0

L12. When you returned was it to work mostly full-time or part-time?

- Full-time 1 0
- Part-time 2 0
- Other (contract, shared job, etc) 3 0
(specify) _____
- Don't know x 0 ▶▶▶L13
- Refused r 0 ▶▶▶L13

L12a. Was it the same job?

- Yes 1 0
- No 3 0
- Don't know x 0
- Refused r 0

L12b. When you returned, did your salary decrease, stay the same or increase from what it was before the work interruption?

- Salary decreased 1 0
- Salary stayed the same 2 0
- Salary increased 3 0
- Don't know x 0
- Refused r 0

If the number given in L3 is greater than 1, go to L15, else go to L14.

L14. Have you taken any other breaks of three months or longer from regular employment?

- Yes 1 0
- No 3 0 ▶▶▶M1
- Don't know x 0 ▶▶▶M1
- Refused r 0 ▶▶▶M1

PREVIOUS INTERRUPTION (2):

L15. In what year did your previous work interruption begin?

- [[[[[]]]]]
- Don't know x 0
- Refused r 0

GSS Cycle 9 Questionnaire

L16. At that time were you working mostly full-time or part-time?

- Full-time ¹ 0
- Part-time ² 0
- Other (contract, shared job, etc.) ³ 0
(specify) _____
- Don't know ^x 0
- Refused ^r 0

L17. What were the reasons you were away from work?
(Enter maximum of 3 reasons)

- Own illness, disability or accident ⁰¹ 0
- Temporary layoff/End of contract ⁰² 0
- Lack of work ⁰³ 0
- Business or company closure ⁰⁴ 0
- Maternity/paternity leave ⁰⁵ 0
- Child care ⁰⁶ 0
- Care of the elderly ⁰⁷ 0
- Personal or family responsibilities (other than child care and care of the elderly) ⁰⁸ 0
- Returned to school ⁰⁹ 0
- Retired ¹⁰ 0 ▶▶L20
- Other ¹¹ 0
(specify) _____
- Don't know ^x 0
- Refused ^r 0

L18. For how long were you away from work before you returned to work on a regular basis, either full or part-time?

- months
- Don't know ^x 0
- Refused ^r 0

L19. When you returned was it to work mostly full-time or part-time?

- Full-time ¹ 0
- Part-time ² 0
- Other (contract, shared job, etc.) ³ 0
(specify) _____
- Don't know ^x 0 ▶▶L20
- Refused ^r 0 ▶▶L20

L19a. Was it the same job?

- Yes ¹ 0
- No ³ 0
- Don't know ^x 0 ▶▶L20
- Refused ^r 0 ▶▶L20

L19b. When you returned, did your salary decrease, stay the same or increase from what it was before the work interruption?

- Salary decreased ¹ 0
- Salary stayed the same ² 0
- Salary increased ³ 0
- Don't know ^x 0
- Refused ^r 0

L20. If the number given in L3 is greater than 2, go to L22, else go to L21.

L21. Have you taken any other breaks of three months or longer from regular employment?

- Yes ¹ 0
- No ³ 0 ▶▶M1
- Don't know ^x 0 ▶▶M1
- Refused ^r 0 ▶▶M1

GSS Cycle 9 Questionnaire

PREVIOUS INTERRUPTION (3):

L22. In what year did your previous work interruption begin?

□□□□

Don't know x 0
 Refused r 0

L23. At that time were you working mostly full-time or part-time?

Full-time 1 0
 Part-time 2 0
 Other (contract, shared job, etc) 3 0
 (specify) _____

Don't know x 0
 Refused r 0

L24. What were the reasons you were away from work?
 (Enter maximum of 3 reasons)

Own illness, disability or accident 01 0
 Temporary Layoff/End of contract 02 0
 Lack of work 03 0
 Business or company closure 04 0
 Maternity leave/paternity leave 05 0
 Child care 06 0
 Care of the elderly 07 0
 Personal or family responsibilities (other than child care and care of the elderly) 08 0
 Returned to school 09 0
 Retired 10 0 ▶▶▶L27
 Other 11 0
 (specify) _____

Don't know x 0
 Refused r 0

L25. For how long were you away from work before you returned to work on a regular basis, either full-time or part-time?

□□ months

Don't know x 0
 Refused r 0

L26. When you returned was it to work mostly full-time or part-time?

Full-time 1 0
 Part-time 2 0
 Other (contract, shared job, etc) 3 0
 (specify) _____

Don't know x 0 ▶▶▶L27
 Refused r 0 ▶▶▶L27

L26a. Was it the same job?

Yes 1 0
 No 3 0
 Don't know x 0
 Refused r 0

L26b. When you returned, did your salary decrease, stay the same or increase from what it was before the work interruption?

Salary decreased 1 0
 Salary stayed the same 2 0
 Salary increased 3 0
 Don't know x 0
 Refused r 0

L27. If the number given in L3 is greater than 3, go to L29, else go to L28.

L28. Have you taken any other breaks of three months or longer from regular employment?

Yes 1 0
 No 3 0 ▶▶▶M1
 Don't know x 0 ▶▶▶M1
 Refused r 0 ▶▶▶M1

GSS Cycle 9 Questionnaire

PREVIOUS INTERRUPTION (4):

L29. In what year did your previous work interruption begin?

□□□□

Don't know x 0
 Refused r 0

L30. At that time were you working mostly full-time or part-time?

Full-time 1 0
 Part-time 2 0
 Other (contract, shared job, etc.) 3 0
 (specify) _____

Don't know x 0
 Refused r 0

L31. What were the reasons you were away from work?
 (Enter maximum of 3 reasons)

Own illness, disability or accident 01 0
 Temporary Layoff/End of contract 02 0
 Lack of work 03 0
 Business or company closure 04 0
 Maternity leave/paternity leave 05 0
 Child care 06 0
 Care of the elderly 07 0
 Personal or family responsibilities (Other than child care and care of the elderly) 08 0
 Returned to school 09 0
 Retired 10 0▶▶M1
 Other 11 0
 (specify) _____

Don't know x 0
 Refused r 0

L32. For how long were you away from work before you returned to work on a regular basis, either full-time or part-time?

□□ months

Don't know x 0
 Refused r 0

L33. When you returned was it to work mostly full-time or part-time?

Full-time 1 0
 Part-time 2 0
 Other (contract, shared job, etc.) 3 0
 (specify) _____

Don't know x 0▶▶M1
 Refused r 0▶▶M1

L33a. Was it the same job?

Yes 1 0
 No 3 0
 Don't know x 0
 Refused r 0

L33b. When you returned, did your salary decrease, stay the same or increase from what it was before the work interruption?

Salary decreased 1 0
 Salary stayed the same 2 0
 Salary increased 3 0
 Don't know x 0
 Refused r 0

SECTION M: SOCIAL ORIGIN

I will now ask you some questions about your parents

M1. When you were 15 years old, did you live with your father?

(Include adoptive father)

- Yes 1 0 ▶▶▶M5
- No 3 0
- Don't know x 0 ▶▶▶M14
- Refused r 0 ▶▶▶M14

M2. Why was this? Was it because...

- your father passed away? ... 1 0
 - your parents were divorced or separated? 2 0
 - you or your father were temporarily living away from home? 3 0 ▶▶▶M4
 - Other 4 0
- (specify) _____

- Don't know x 0
- Refused r 0

M3. During that time, was there a person who acted as a father substitute in your home?

- Yes 1 0 ▶▶▶M5
- No 3 0
- Don't know x 0 ▶▶▶M14
- Refused r 0 ▶▶▶M14

If answer to M2 is "your father passed away" and answer to M3 is "No" then go to M14

M4. Did you have regular contacts with your natural father?

- Yes 1 0
- No 3 0 ▶▶▶M14
- Don't know x 0 ▶▶▶M14
- Refused r 0 ▶▶▶M14

M5. When you were 15 years old, was your father's (or father's substitute) main activity working at a job or a business, looking for work, going to school, keeping house, retired or something else?

(Enter one only)
(Note: If sickness or short-term illness is reported, ask for usual major activity)

- Working at a job or business ... 1 0
 - Looking for work 2 0 ▶▶▶M10
 - Going to school 3 0 ▶▶▶M10
 - Keeping house 4 0 ▶▶▶M10
 - Retired 5 0 ▶▶▶M10
 - Something else:
 - Paternity leave 6 0 ▶▶▶M10
 - Long term illness 7 0 ▶▶▶M10
 - Other 8 0 ▶▶▶M10
- (specify) _____

- Don't know x 0 ▶▶▶M10
- Refused r 0 ▶▶▶M10

M6. For whom did he work at that job?

(Name of business, government department or agency, or person)

- Don't know x 0
- Refused r 0

M7. What kind of business, industry or service was this?

(Give full description: e.g. federal government, canning industry, forestry services)

- Don't know x 0
- Refused r 0

GSS Cycle 9 Questionnaire

M8. What kind of work was he doing?
(Give full description: e.g. office clerk, factory worker, forestry technician)

Don't know x 0
Refused r 0

M9. In that work, what were his most important activities or duties?

(Give full description: e.g. filing documents, drying vegetables, forestry examiner)

Don't know x 0
Refused r 0

M10. Does your father (or father's substitute) have a high school diploma?

Yes 1 0
No 3 0
Don't know x 0 → M12
Refused r 0 → M12

M11. Has your father (or father's substitute) had any schooling beyond high school?

Yes 1 0
No 3 0
Don't know x 0 → M13
Refused r 0 → M13

If M10=1 and M11=3 go to M13

M12. What is the highest level of education your father (or father's substitute) has attained?
(Enter one only and verify whether or not studies have been completed)

- Earned doctorate (e.g. Ph.D, D.Sc., D.Ed.) 01 0
- Some graduate studies at doctorate level 02 0
- Master's degree (e.g. M.A., M.Sc., M.Ed.) 03 0
- Some graduate studies at Master's level 04 0
- First professional degree in medicine (M.D.), dentistry (DDS., D.M.D.), veterinary medicine (D.V.M.), law (L.L.B.), optometry (O.D.) or divinity (M.DIV.), or 1-year B.Ed. after a Bachelor's degree 05 0
- Bachelor's degree (e.g. B.A., B.Sc., B.A.Sc., B.Ed.) 06 0
- Some university 07 0
- Diploma or certificate from community college, CEGEP or nursing school ... 08 0
- Some community college, CEGEP or nursing school ... 09 0
- Diploma or certificate from trade, technical or vocational school, or business college ... 10 0
- Some trade, technical or vocational school, or business college 11 0
- Some secondary/high school ... 12 0
- Elementary school completed . 13 0
- Some elementary school 14 0
- No schooling 15 0
- Other 16 0
(specify) _____

Don't know x 0
Refused r 0

GSS Cycle 9 Questionnaire

M13. In what country was he born?
 Canada 1 0
 >>> **In which province or territory?**

- Newfoundland 10 0
- Prince Edward Island 11 0
- Nova Scotia 12 0
- New Brunswick 13 0
- Quebec 14 0
- Ontario 15 0
- Manitoba 16 0
- Saskatchewan 17 0
- Alberta 18 0
- British Columbia 19 0
- Yukon Territory 20 0
- Northwest Territories 21 0

- Foreign Country 2 0
- China 01 0
- England 02 0
- France 03 0
- Germany 04 0
- Haiti 05 0
- Holland 06 0
- India 07 0
- Ireland 08 0
- Italy 09 0
- Jamaica 10 0
- Philippines 11 0
- Poland 12 0
- Portugal 13 0
- Scotland 14 0
- United States 15 0
- Commonwealth of Soviet States 16 0
- Other 17 0

(specify) _____
 Don't know x 0
 Refused r 0

M14. When you were 15 years old, did you live with your mother?
 (Include adoptive mother)

- Yes 1 0>>>M18
- No 3 0
- Don't know x 0>>>M27
- Refused r 0>>>M27

M15. Why was this? Was it because...

- your mother passed away? .. 1 0
 - your parents were divorced or separated? 2 0
 - you or your mother were temporarily living away from home? 3 0>>>M17
 - Other 4 0
- (specify) _____

Don't know x 0
 Refused r 0

M16. During that time, was there a person who acted as a mother substitute in your home?

- Yes 1 0>>>M18
- No 3 0
- Don't know x 0>>>M27
- Refused r 0>>>M27

If answer to M15 is "your mother passed away" and answer to M16 is "No" then go to M27.

M17. Did you have regular contacts with your natural mother?

- Yes 1 0
- No 3 0>>>M27
- Don't know x 0>>>M27
- Refused r 0>>>M27

GSS Cycle 9 Questionnaire

M18. When you were 15 years old, was your mother's (or mother's substitute) main activity working at a job or a business, looking for work, going to school, keeping house, retired or something else?

(Enter one only)

(Note: If sickness or short-term illness is reported, ask for usual major activity)

- Working at a job or business . . . 1 0
 - Looking for work 2 0▶▶M23
 - Going to school 3 0▶▶M23
 - Keeping house 4 0▶▶M23
 - Retired 5 0▶▶M23
 - Something else:
 - Maternity leave 6 0▶▶M23
 - Long term illness 7 0▶▶M23
 - Other 8 0▶▶M23
- (specify) _____

- Don't know x 0▶▶M23
- Refused r 0▶▶M23

M19. For whom did she work at that job?

(Name of business, government department or agency, or person)

- Don't know x 0
- Refused r 0

M20. What kind of business, industry was this? (Give full description: e.g. federal government, canning industry, forestry service)

- Don't know x 0
- Refused r 0

M21. What kind of work was she doing?

(Give full description: e.g. office clerk, factory worker, forestry technician)

- Don't know x 0
- Refused r 0

M22. In that work, what were her most important activities or duties?

(Give full description: e.g. filing documents, drying vegetables, forestry examiner)

- Don't know x 0
- Refused r 0

M23. Does your mother (or mother's substitute) have a high school diploma?

- Yes 1 0
- No 3 0
- Don't know x 0▶▶M25
- Refused r 0▶▶M25

M24. Has your mother (or mother's substitute) had any schooling beyond high school?

- Yes 1 0
- No 3 0
- Don't know x 0▶▶M26
- Refused r 0▶▶M26

If M23=1 and M24=3 go to M26

GSS Cycle 9 Questionnaire

M25. What is the highest level of education your mother (or mother's substitute) has attained?
(Enter one only and verify whether or Not studies have been completed)

- Earned doctorate (e.g. D.Sc., D.Ed.) 01 0
- Some graduate studies at doctorate level 02 0
- Master's degree (e.g. M.A., M.Sc., M.Ed.) 03 0
- Some graduate studies at Master's level 04 0
- First professional degree in medicine (M.D.), dentistry (DDS., D.M.D.), veterinary medicine (D.V.M.), law (Ll.B.), optometry (O.D.) or divinity (M.Div.), or 1-year B.Ed. after a Bachelor's degree 05 0
- Bachelor's degree (e.g. B.A., B.Sc., B.A.Sc., B.Ed.) 06 0
- Some university 07 0
- Diploma or certificate from community college, CEGEP or nursing school 08 0
- Some community college, CEGEP or nursing school ... 09 0
- Diploma or certificate from trade, technical or vocational school, or business college 10 0
- Some trade, technical or vocational school, or business college 11 0
- Some secondary/high school .. 12 0
- Elementary school completed . 13 0
- Some elementary school 14 0
- No schooling 15 0
- Other 16 0
(specify) _____
- Don't know x 0
- Refused r 0

M26. In what country was she born?

- Canada 0
- ▶▶▶ In which province or territory?
- Newfoundland 10 0
- Prince Edward Island 11 0
- Nova Scotia 12 0
- New Brunswick 13 0
- Quebec 14 0
- Ontario 15 0
- Manitoba 16 0
- Saskatchewan 17 0
- Alberta 18 0
- British Columbia 19 0
- Yukon Territory 20 0
- Northwest Territories 21 0
- Foreign Country 2 0
- China 01 0
- England 02 0
- France 03 0
- Germany 04 0
- Haiti 05 0
- Holland 06 0
- India 07 0
- Ireland 08 0
- Italy 09 0
- Jamaica 10 0
- Philippines 11 0
- Poland 12 0
- Portugal 13 0
- Scotland 14 0
- United States 15 0
- Commonwealth of Soviet States 16 0
- Other 17 0
(specify) _____
- Don't know x 0
- Refused r 0

GSS Cycle 9 Questionnaire

M27. How many brothers do you have?
(Including step/half-brothers, adopted brothers or brothers that died)

□□ brothers

Don't know x 0▶▶▶N1

Refused r 0▶▶▶N1

M28. How many sisters do you have?
(Including step/ half-sisters, adopted sisters or sisters that died)

□□ sisters

Don't know x 0▶▶▶N1

Refused r 0▶▶▶N1

Compute the number of children in the family (M27+M28+1) and place this number in the following question, unless the sum equals 1; then go to N1.

M30. Amongst the "X" children of your family, which rank do you hold ?
(rank "1" should be given to the eldest)

□□ rank

Don't know x 0

Refused r 0

For information only

GSS Cycle 9 Questionnaire

SECTION N: COMPUTER USE AND RELATED MATERIAL

N1. Have you ever taken any courses on how to use computers?

Yes 1 0
 No 3 0
 Don't know x 0
 Refused r 0

N2. Can you do anything on a computer (excluding video games, e.g. Nintendo), for example, word processing or data entry?

Yes 1 0
 No 3 0 ▶▶▶ N4
 Don't know x 0 ▶▶▶ N4
 Refused r 0 ▶▶▶ N4

N3. In the last 12 months, have you done any of the following on a computer?

a) Playing games?

Yes 1 0
 No 3 0
 Don't know x 0
 Refused r 0

b) Word processing?

Yes 1 0
 No 3 0
 Don't know x 0
 Refused r 0

c) Data entry?

Yes 1 0
 No 3 0
 Don't know x 0
 Refused r 0

d) Record keeping?

Yes 1 0
 No 3 0
 Don't know x 0
 Refused r 0

e) Data analysis?

Yes 1 0
 No 3 0
 Don't know x 0
 Refused r 0

f) Writing computer programs?

Yes 1 0
 No 3 0
 Don't know x 0
 Refused r 0

g) Use an on-line dataservice such as COMPUSERVE, INTERNET OR PRODIGY?

Yes 1 0
 No 3 0
 Don't know x 0
 Refused r 0

h) Anything else?

Yes 1 0
 (specify) _____
 No 3 0
 Don't know x 0
 Refused r 0

GSS Cycle 9 Questionnaire

N4. Do you have a personal computer at home (excluding video games like Nintendo)?

- Yes 1 0
- No 3 0▶▶▶N7
- Don't know x 0▶▶▶N7
- Refused r 0▶▶▶N7

N5. Do you personally use that computer?

- Yes 1 0
- No 3 0▶▶▶N7
- Don't know x 0▶▶▶N7
- Refused r 0▶▶▶N7

N6. How many hours per week do you Normally use it?

- hours
- Don't know x 0
 - Refused r 0

N7. In the past 12 months, did you use the following devices, at least once a week, at least once a month, less than once a month or never?

a) Automated Banking Machine?

- At least once a week 1 0
- At least once a month 2 0
- Less than a month 3 0
- Never 4 0
- Don't know x 0
- Refused r 0

b) Video Cassette Recorder?

- At least once a week 1 0
- At least once a month 2 0
- Less than a month 3 0
- Never 4 0
- Don't know x 0
- Refused r 0

c) Fax Machine?

- At least once a week 1 0
- At least once a month 2 0
- Less than a month 3 0
- Never 4 0
- Don't know x 0
- Refused r 0

d) Telephone Answering Machine?

- At least once a week 1 0
- At least once a month 2 0
- Less than a month 3 0
- Never 4 0
- Don't know x 0
- Refused r 0

e) Photocopier?

- At least once a week 1 0
- At least once a month 2 0
- Less than a month 3 0
- Never 4 0
- Don't know x 0
- Refused r 0

N8. The next few questions refer to unpaid activities.

N9. During the past 7 days, how many hours did you spend doing the following activities?

a) Looking after one or more of your own children, or the children of others, WITHOUT PAY?

(Some examples include: swimming or playing with young children, driving children to sports activities, helping with homework, talking with teens about their problems)

- None 1 0
- Less than 5 hours 2 0
- 5 to 14 hours 3 0
- 15 to 29 hours 4 0
- 30 to 44 hours 5 0
- 45 to 59 hours 6 0
- 60 hours or more 7 0
- Don't know x 0
- Refused r 0

GSS Cycle 9 Questionnaire

(b) Doing UNPAID HOUSEWORK, yard work or home maintenance for members of this household, or others ?

(Some examples include: preparing meals, doing laundry, household planning, shopping and cutting the grass)

- None 1 0
- Less than 5 hours 2 0
- 5 to 14 hours 3 0
- 15 to 29 hours 4 0
- 30 to 44 hours 5 0
- 45 to 59 hours 6 0
- 60 hours or more 7 0
- Don't know x 0
- Refused r 0

© Providing UNPAID CARE or assistance to one or more seniors ?

(Some examples include: visiting, talking with seniors on the telephone, helping with shopping, banking, or with taking medication, driving to appointments or other activities)

- None 1 0
- Less than 5 hours 2 0
- 5 to 9 hours 3 0
- 10 or more 4 0
- Don't know x 0
- Refused r 0

(d) Providing UNPAID CARE or assistance to persons other than children or seniors ?

(Some examples include: helping with banking, driving to appointments, house-sitting for neighbours)

- None 1 0
- Less than 5 hours 2 0
- 5 to 9 hours 3 0
- 10 or more 4 0
- Don't know x 0
- Refused r 0

N10. During the past 7 days, how many hours did you spend doing VOLUNTEER ACTIVITIES for a non-profit organization, a religious organization, a charity or a community group ?

(Some examples include: organizing a special event, advocating for a cause, canvassing or fundraising, coaching or teaching, serving on a committee or board of directors)

- None 1 0
- Less than 5 hours 2 0
- 5 to 9 hours 3 0
- 10 or more 4 0
- Don't know x 0
- Refused r 0

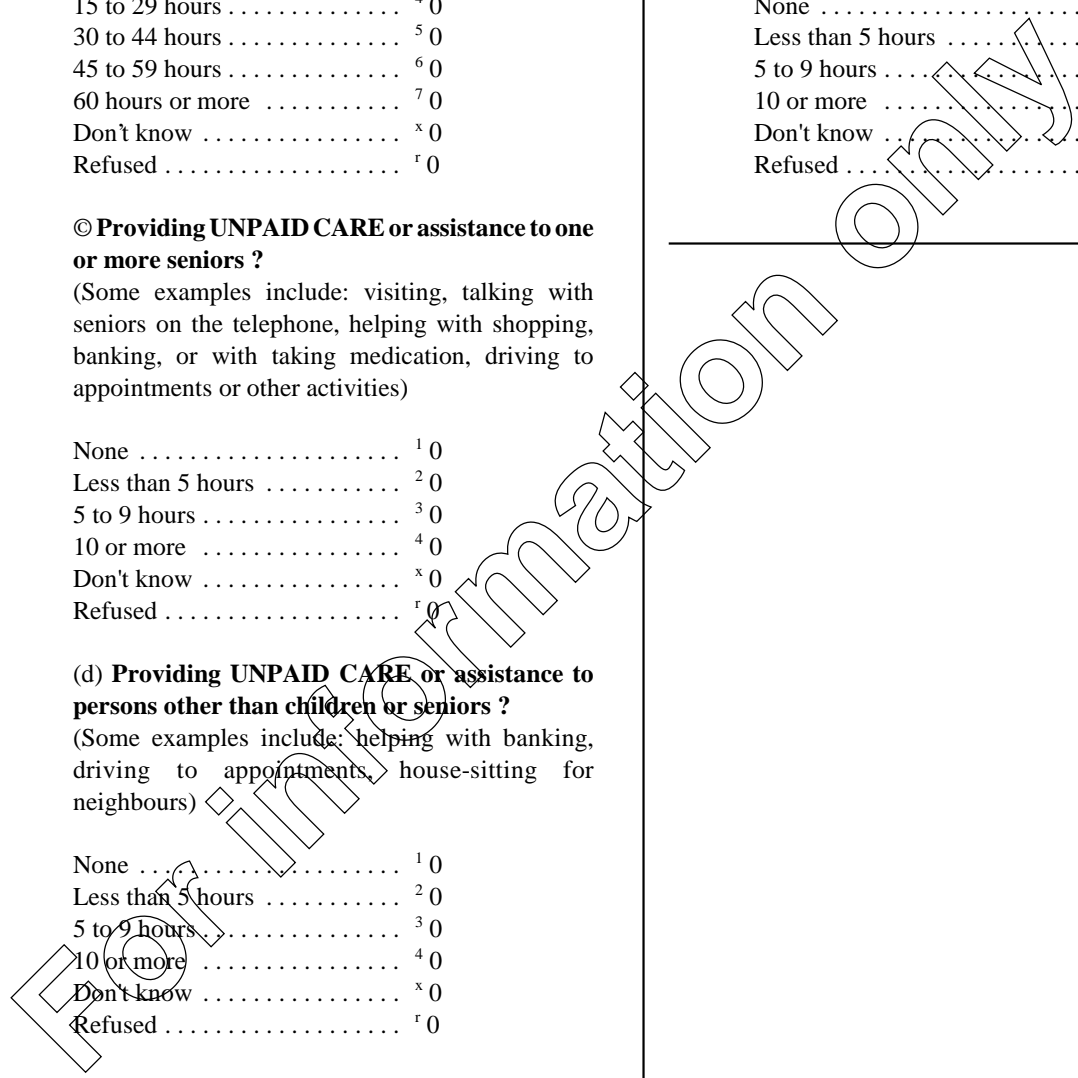

GSS Cycle 9 Questionnaire

SECTION P: OTHER CLASSIFICATION

P1. Now, I'd like to ask you a few general questions.

P2. What is your date of birth?

□□ □□ □□□□
Day Month Year

Don't know x 0
Refused r 0

P3. In what country were you born?

Canada 1 0

▶▶▶ In which province or territory?

Newfoundland 10 0

Prince Edward Island 11 0

Nova Scotia 12 0

New Brunswick 13 0

Quebec 14 0

Ontario 15 0

Manitoba 16 0

Saskatchewan 17 0

Alberta 18 0

British Columbia 19 0

Yukon Territory 20 0

Northwest Territories 21 0

Foreign Country 2 0

China 01 0

England 02 0

France 03 0

Germany 04 0

Haiti 05 0

Holland 06 0

India 07 0

Ireland 08 0

Italy 09 0

Jamaica 10 0

Philippines 11 0

Poland 12 0

Portugal 13 0

Scotland 14 0

United States 15 0

Commonwealth of Soviet

States 16 0

Other 17 0

(specify) _____

Don't know x 0▶▶▶P5

Refused r 0▶▶▶P5

If P3 = one Canadian province, go to P5.

For information only

GSS Cycle 9 Questionnaire

P4. In what year did you first immigrate to Canada?

LLLLL

Canadian citizen by birth ¹ 0
 Don't know ^x 0
 Refused ^r 0

P5. What language did you first speak in childhood?
 (Accept multiple responses only if languages were used equally.)

P5A. Do you still understand that/those language(s)?

		
		Yes	No
English	⁰¹ 0		
French	⁰² 0▶▶▶	¹ 0	³ 0
Italian	⁰³ 0▶▶▶	¹ 0	³ 0
Chinese	⁰⁴ 0▶▶▶	¹ 0	³ 0
German	⁰⁵ 0▶▶▶	¹ 0	³ 0
Portuguese	⁰⁶ 0▶▶▶	¹ 0	³ 0
Polish	⁰⁷ 0▶▶▶	¹ 0	³ 0
Ukrainian	⁰⁸ 0▶▶▶	¹ 0	³ 0
Spanish	⁰⁹ 0▶▶▶	¹ 0	³ 0
Dutch	¹⁰ 0▶▶▶	¹ 0	³ 0
Greek	¹¹ 0▶▶▶	¹ 0	³ 0
Punjabi	¹² 0▶▶▶	¹ 0	³ 0
Arabic	¹³ 0▶▶▶	¹ 0	³ 0
Tagalog (Pilipino)	¹⁴ 0▶▶▶	¹ 0	³ 0
Hungarian	¹⁵ 0▶▶▶	¹ 0	³ 0
Other	¹⁶ 0▶▶▶	¹ 0	³ 0
(specify) _____			
Don't know		^x 0	
Refused			^r 0

P6. What language do you speak most often at home?

(Accept multiple responses only if languages are spoken equally)

English	⁰¹ 0
French	⁰² 0
Chinese	⁰³ 0
Italian	⁰⁴ 0
Portuguese	⁰⁵ 0
Spanish	⁰⁶ 0
German	⁰⁷ 0
Polish	⁰⁸ 0
Punjabi	⁰⁹ 0
Greek	¹⁰ 0
Vietnamese	¹¹ 0
Arabic	¹² 0
Cree	¹³ 0
Tagalog (Pilipino)	¹⁴ 0
Ukrainian	¹⁵ 0
Other	¹⁶ 0
(specify) _____	
Don't know	^x 0
Refused	^r 0

P7. What is your religion?

No religion	⁰⁰ 0▶▶▶P9
Roman Catholic	⁰¹ 0
Ukrainian Catholic	⁰² 0
United Church	⁰³ 0
Anglican	⁰⁴ 0
Presbyterian	⁰⁵ 0
Lutheran	⁰⁶ 0
Baptist	⁰⁷ 0
Pentecostal	⁰⁸ 0
Eastern Orthodox	⁰⁹ 0
Jewish	¹⁰ 0
Islam (Muslim)	¹¹ 0
Hindu	¹² 0
Buddhist	¹³ 0
Sikh	¹⁴ 0
Jehovah's Witnesses	¹⁵ 0
Other	¹⁶ 0
(specify) _____	
Don't know	^x 0▶▶▶P9
Refused	^r 0▶▶▶P9

For Information Only

GSS Cycle 9 Questionnaire

P8. Other than on special occasions, (such as weddings, funerals or baptisms) how often did you attend religious services or meetings in the last 12 months? Was it...

- at least once a week? 1 0
- at least once a month? 2 0
- a few times a year? 3 0
- at least once a year? 4 0
- Not at all? 5 0
- Don't know x 0
- Refused r 0

P8b. The next few questions concern your physical condition.

P9. Compared to other people your age, how would you describe your state of health? Would you say it is...

- Excellent? 1 0
- Very good? 2 0
- Good? 3 0
- Fair? 4 0
- Poor? 5 0
- Don't know x 0
- Refused r 0

P9a. How tall are you without your shoes on?

□□□□ or □□□□
 Feet Inches metre Centimetres

- Don't know x 0
- Refused r 0

For information only

P9B. How much do you weigh?

□□□□ or □□□□
 Pounds Kilograms

- Don't know x 0
- Refused r 0

P10. Are you limited in the amount or kind of activity you can do at home, at work or at school because of a long-term physical condition or health problem?

(By long-term, we mean more than 6 months)

- Yes 1 0
- No ³ 0 ▶▶▶ P12
- Don't know x 0 ▶▶▶ P12
- Refused r 0 ▶▶▶ P12

P11. What is the main condition or health problem that limits you?

- Don't know x 0
- Refused r 0

P12. During the past twelve months, from which of the following sources, did you personally receive an income?

a) From wages, salary or self-employment?

- Yes 1 0
- No ³ 0
- Don't know x 0
- Refused r 0
- No source of income ⁵ 0

b) From government, such as Family Allowance, employment Insurance, Social Assistance, Canada or Quebec Pension Plan or Old Age Security?

- Yes 1 0
- No ³ 0
- Don't know x 0
- Refused r 0

GSS Cycle 9 Questionnaire

c) From interest, dividends, investments?

Yes¹ 0
 No³ 0
 Don't know^x 0
 Refused^r 0

d) From private pensions?

Yes¹ 0
 No³ 0
 Don't know^x 0
 Refused^r 0

e) From any other sources, such as scholarships, child support payments etc.?

Yes¹ 0
 No³ 0
 Other⁵ 0
 (specify) _____
 Don't know^x 0
 Refused^r 0

Question P13 must be asked only to those who answered "Yes" to question G4 or G10 or values 1, 2, 3, 4, 5, 6 or 7 to question G10b. If H1 = "No" then the P13-1 wording is used; if H1 = "Yes / Don't know / Refused" then the P13-2 wording is used. Questions P14 and P14a must be asked only to those who answered "No" to question G10 when question G9 >= 1. All respondents are asked question P14c.

P13-1. What is your current wage or salary before deductions from all sources?

P13-2. What is your current wages or salary coming from the job at which you spend the most hours, before deductions from all sources?

\$ [] [] [] [] [] [] [] [] [] []

Hourly¹ 0 >>> P14b
 Daily² 0 >>> P14b
 Weekly³ 0 >>> P14b
 Every two weeks⁴ 0 >>> P14b
 Twice a month⁵ 0 >>> P14b
 Monthly⁶ 0 >>> P14b
 Yearly⁷ 0 >>> P14b
 Other⁸ 0 >>> P14b
 (specify) _____
 No income or loss⁰ 0 >>> P14b
 Don't know^x 0
 Refused^r 0

If the respondent has been asked question P13-1, then question P13a-1 must be asked. If the respondent has been asked question P13-2, then question P13a-2 must be asked.

For information only

GSS Cycle 9 Questionnaire

P13a-1. Could you give us an estimation of your current wage or salary before deductions from all sources. Is it...

P13a-2. Could you give us an estimation of your current wage or salary coming from the job at which you spend the most hours, before deductions from all sources. Is it ...

Less than 20,000?	¹ 0	{ Less than \$10,000? ¹ 0 or \$10,000 and more? ² 0 }	{ Less than \$5,000 ? ¹ 0 or \$5,000 and more? ² 0 }
\$20,000 and more?	² 0	{ Less than \$40,000? ¹ 0 or \$40,000 and more? ² 0 }	{ Less than \$30,000? ¹ 0 or \$30,000 and more? ² 0 }
No income or loss	⁰ 0		
Don't know	^x 0		
Refused	^r 0		

P14. During the last 12 months, what has been your wage or salary coming from the job at which you spend the most hours, before deductions from all sources?

\$

Hourly ¹ 0 >>> P14b

Daily ² 0 >>> P14b

Weekly ³ 0 >>> P14b

Every two weeks ⁴ 0 >>> P14b

Twice a month ⁵ 0 >>> P14b

Monthly ⁶ 0 >>> P14b

Yearly ⁷ 0 >>> P14b

Other ⁸ 0 >>> P14b

(specify)

No income or loss ⁰ >>> P14b

Don't know ^x 0

Refused ^r 0

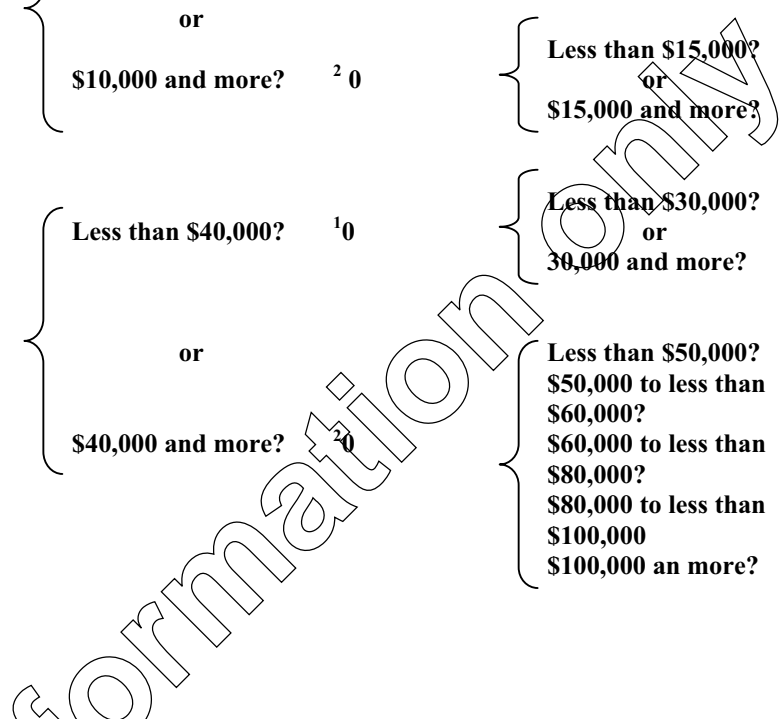

GSS Cycle 9 Questionnaire

P14a. Could you give us an estimation of your wage or salary coming from the job at which you spend the most hours, before deductions from all sources. Is it...

Less than 20,000? ¹ 0	{	Less than \$10,000? ¹ 0	or	\$10,000 and more? ² 0	{	Less than \$5,000 ? ¹ 0 or \$5,000 and more? ² 0
or						Less than \$15,000? ¹ 0 or \$15,000 and more? ² 0
\$20,000 and more? ² 0	{	Less than \$40,000? ¹ 0	or	\$40,000 and more? ² 0	{	Less than \$30,000? ¹ 0 or \$30,000 and more? ² 0
						Less than \$50,000? ¹ 0 \$50,000 to less than \$60,000? ² 0 \$60,000 to less than \$80,000? ³ 0 \$80,000 to less than \$100,000 ⁴ 0 \$100,000 an more? ⁵ 0

No income or loss ⁰ 0
 Don't know ^x 0
 Refused ^r 0

P14b. What in your opinion was the wage/ salary you deserved for this work, all things considered?

\$

Hourly ¹ 0
 Daily ² 0
 Weekly ³ 0
 Every two weeks ⁴ 0
 Twice a month ⁵ 0
 Monthly ⁶ 0
 Yearly ⁷ 0
 Other ⁸ 0
 (specify) _____

Don't know ^x 0
 Refused ^r 0

GSS Cycle 9 Questionnaire

P14c. What is your best estimate of your own personal income before deductions from all sources during the past 12 months? Was your income...

Same as P13 or P14 ¹ 0

Less than 20,000?	¹ 0	{ Less than \$10,000? or \$10,000 and more? }	¹ 0 ² 0	{ Less than \$5,000 ? or \$5,000 and more? }	¹ 0 ² 0
\$20,000 and more?	² 0	{ Less than \$40,000? or \$40,000 and more? }	¹ 0 ² 0	{ Less than \$30,000? or \$30,000 and more? }	¹ 0 ² 0
No income or loss	⁰ 0				
Don't know	x 0				
Refused	r 0				

If a response was given in K2, H72 or J26 go to P14d, otherwise go to P15.

For information

GSS Cycle 9 Questionnaire

P14d. Comparing your financial situation at the time when you retired with your situation today, would you say that you are now...

- better off? 1 0▶▶▶P14e
- worse off? 2 0▶▶▶P14f
- about the same? 3 0▶▶▶P15
- Don't know x 0▶▶▶P15
- Refused r 0▶▶▶P15

P14e. Has your financial situation improved...

- a great deal? 1 0
- somewhat? 2 0
- Don't know x 0
- Refused r 0

go to P15

P14f. Has your financial situation worsened...

- a great deal? 1 0
- somewhat? 2 0
- Don't know x 0
- Refused r 0

If the respondent is living with his/her spouse or partner continue with P16, otherwise go to P21.

P16. What is the highest level of education your spouse/partner attained?

- Earned doctorate (e.g. Ph.D, D.Sc., D.Ed.) 01 0
- Some graduate studies at the doctorate level 02 0
- Master's degree (e.g. M.A., M.Sc., M.Ed.) 03 0
- Some graduate studies at the Master's level 04 0
- First professional degree in medicine (M.D.) dentistry (DDS., D.M.D.), veterinary medicine (D.V.M.), law (LL.B.), optometry (O.D.) or divinity (M.DIV.), or 1-year B.Ed after a Bachelor's degree (e.g. B.A.,B.Sc., B.A.Sc., B.Ed) 05 0
- Bachelor's degree 06 0
- Some university 07 0
- Diploma or certificate from community college, GEGEP or nursing school 08 0
- Some community college, CEGEP or nursing school 09 0
- Diploma or certificate from trade, technical or vocational school, or business college 10 0
- Some trade, technical or vocational school, or business college 11 0
- High school diploma 12 0
- Some secondary/high school 13 0
- Elementary school 14 0
- Some elementary school 15 0
- Number of years completed▶▶▶ □
- No schooling 16 0
- Other 17 0
- (specify) _____
- Don't know x 0
- Refused r 0

For information only

GSS Cycle 9 Questionnaire

P17. During the last 12 months, was your spouse's/partner's main activity working at a job or business, looking for work, going to school, keeping house, retired or something else?

(Note: if sickness or short term illness is reported, ask for spouse's usual major activity)

- Working at a job or business 1 0 ▶▶▶P19
 - Looking for work 2 0
 - Going to school 3 0
 - Keeping house 4 0
 - Retired 5 0
 - Something else
 - Maternity/paternity leave 6 0
 - Long term illness 7 0
 - Other 8 0
 - (specify) _____
 - Don't know x 0
 - Refused r 0
-

P18. Did your spouse/partner have a job or was he/she self-employed at any time during the last 12 months?

- Yes 1 0
 - No 3 0 ▶▶▶P20
 - Don't know x 0 ▶▶▶P20
 - Refused r 0 ▶▶▶P20
-

P19. During the last 12 months, for how many months or weeks did your spouse/partner do any work at a job or a business?

(Include vacation, illness, strikes, lock-outs and maternity/ paternity leave)

- months
 - weeks
 - Don't know x 0
 - Refused r 0
-

In one-person households go to P23.

P21. Not including yourself, how many other household members received income from any source, during the past 12 months?

□□ members

- Don't know x 0
 - Refused r 0
-

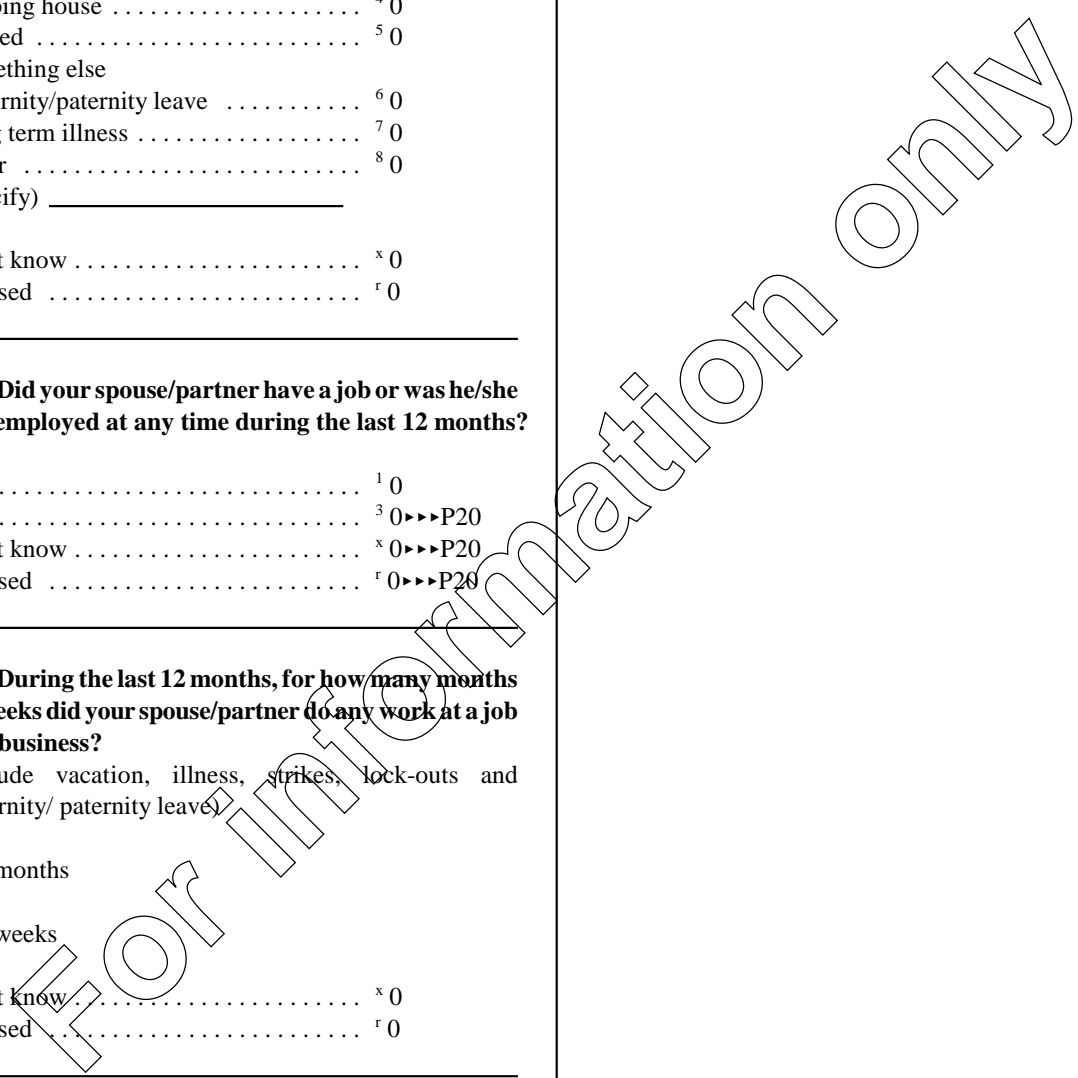

GSS Cycle 9 Questionnaire

P22. What is your best estimate of the total income of all household members from all sources during the past 12 months? Was the total household income...

Same as in P13 or P14 1 0

<p>Less than 20,000? ¹ 0</p> <p>or</p> <p>\$20,000 and more? ² 0</p>	<p>Less than \$10,000? ¹ 0</p> <p>or</p> <p>\$10,000 and more? ² 0</p>	<p>Less than \$5,000 ? ¹ 0</p> <p>or</p> <p>\$5,000 and more? ² 0</p>
	<p>Less than \$30,000? ¹ 0</p> <p>or</p> <p>\$30,000 and more? ² 0</p>	<p>Less than \$50,000? ¹ 0</p> <p>\$50,000 to less than \$60,000? ² 0</p> <p>\$60,000 to less than \$80,000? ³ 0</p> <p>\$80,000 to less than \$100,000 ⁴ 0</p> <p>\$100,000 and more? ⁵ 0</p>

No income or loss 0 0
 Don't know 0 0
 Refused 0 0

For information

GSS Cycle 9 Questionnaire

P23. In what type of dwelling are you now living? Is it a...

- Single detached house? 1 0
- Semi-detached or double?
(side by side) 2 0
- Garden house, town-house
or row house? 3 0
- Duplex? (one above the other) 4 0
- Low-rise apartment?
(less than five stories) 5 0
- High-rise apartment?
(5 or more stories) 6 0
- Trailer house? 7 0
- Another type of dwelling? ... 8 0
(specify) _____

Don't know x 0
Refused r 0

P24. Is this dwelling owned by a member of this household?

- Yes 1 0
- No 3 0
- Don't know x 0
- Refused r 0

P25. What is your postal code (for this residence)?

□□□□□□

Don't know x 0
Refused r 0

P26. Do you have more than one telephone in your home?

- Yes 1 0
- No 3 0▶▶▶P32
- Don't know x 0▶▶▶P32
- Refused r 0▶▶▶P32

P27. Do all the telephones have the same number?

- Yes 1 0▶▶▶P32
- No 3 0
- Don't know x 0▶▶▶P32
- Refused r 0▶▶▶P32

Households with more than one telephone number have a greater chance of being selected by the survey. We ask these questions to adjust for this.

P29. How many numbers are there?

numbers

Don't know x 0▶▶▶P32
Refused r 0▶▶▶P32

P30. Are any of these numbers for business use only?

- Yes 1 0
- No 3 0▶▶▶P32
- Don't know x 0▶▶▶P32
- Refused r 0▶▶▶P32

P31. How many are for business use only?

Business numbers

Don't know x 0
Refused r 0

GSS Cycle 9 Questionnaire

This survey is part of a long-term project to investigate the relationship between education and work. For this reason, we may need to contact your household in a year or more from now.

In case you move or change phone numbers, we would like to obtain your complete name and address. This information will be kept strictly confidential and will only be used to maintain contact with you.

Refused to provide information ¹ 0▶▶P39

Refused to participate in future surveys ² 0▶▶P39

P33. What is your surname?

P34. What is your address?

Street and Number/Lot and Concession

City, Town, Village, Municipality

Province, Territory

P35. Would you please give me the name, address and telephone number of someone we could contact if you move, such as a friend, relative or neighbour. (I want to emphasize that we will contact this person only if you move and then only to obtain your new address or telephone number).

Unable to provide contact ¹ 0▶▶P39

P36. What is the name of the contact?

Given Name _____

Surname _____

P37. What is the address of the contact?

Street and Number/Lot and Concession

City, Town, Village Municipality

Province, Territory

Postal Code

P38. What is the telephone number of the contact?

|||_|-|||_|-|||_|

Thank the respondent and end the interview.

For information only

APPENDIX C

For information only

SECTION A: EDUCATION

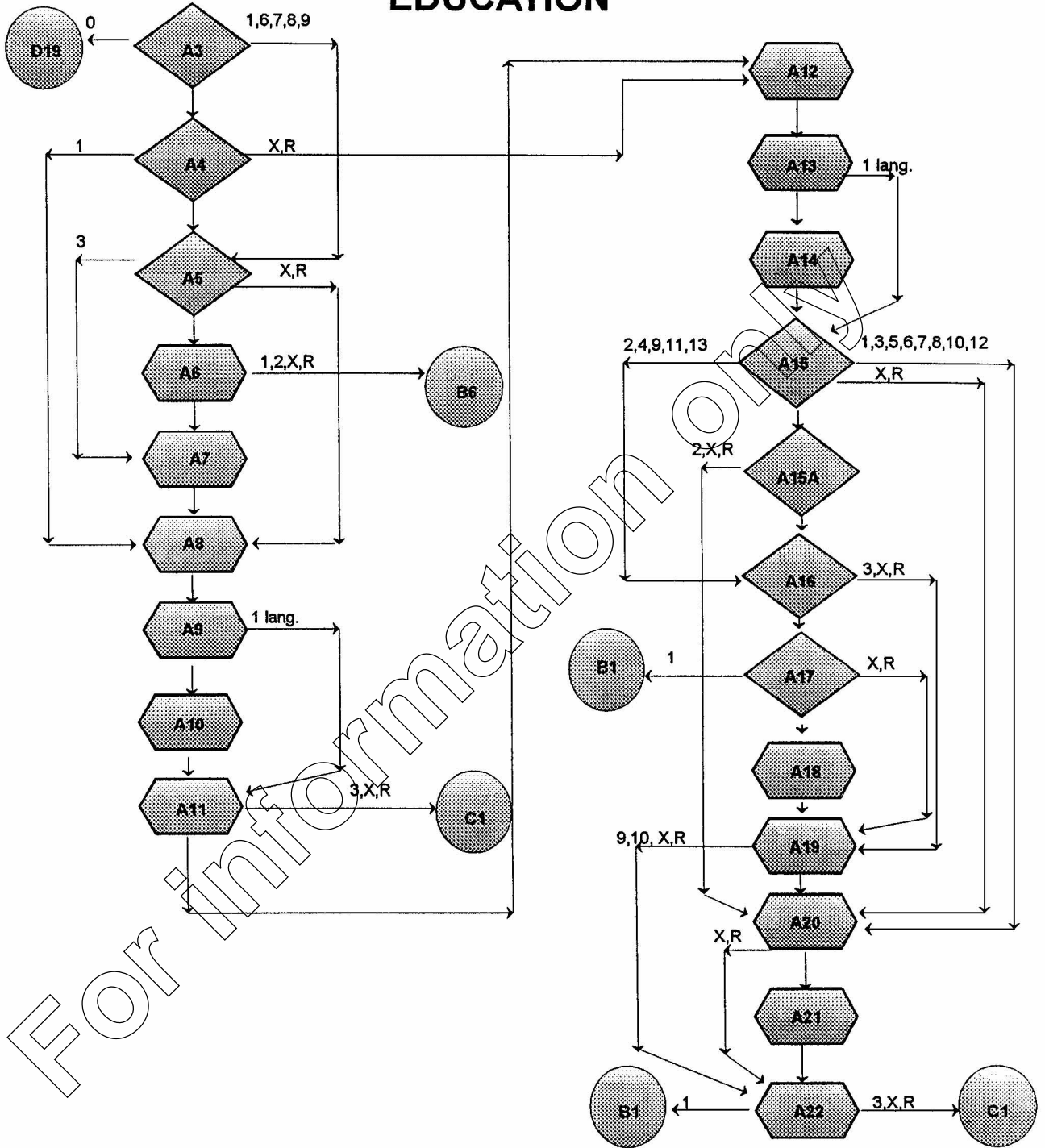

SECTION B CURRENT EDUCATION

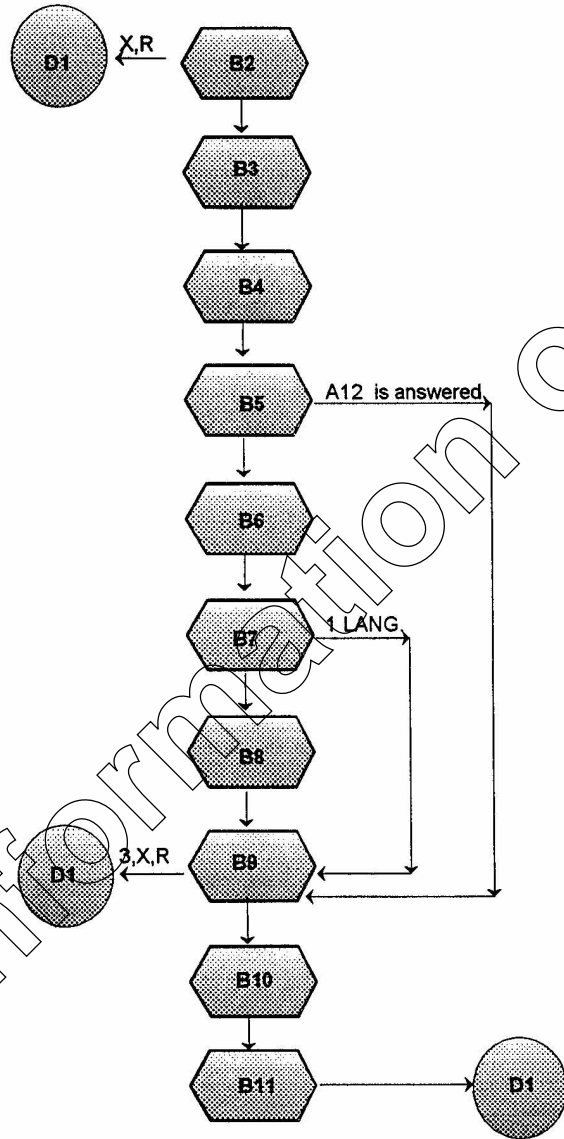

SECTION C: AFTER EDUCATION

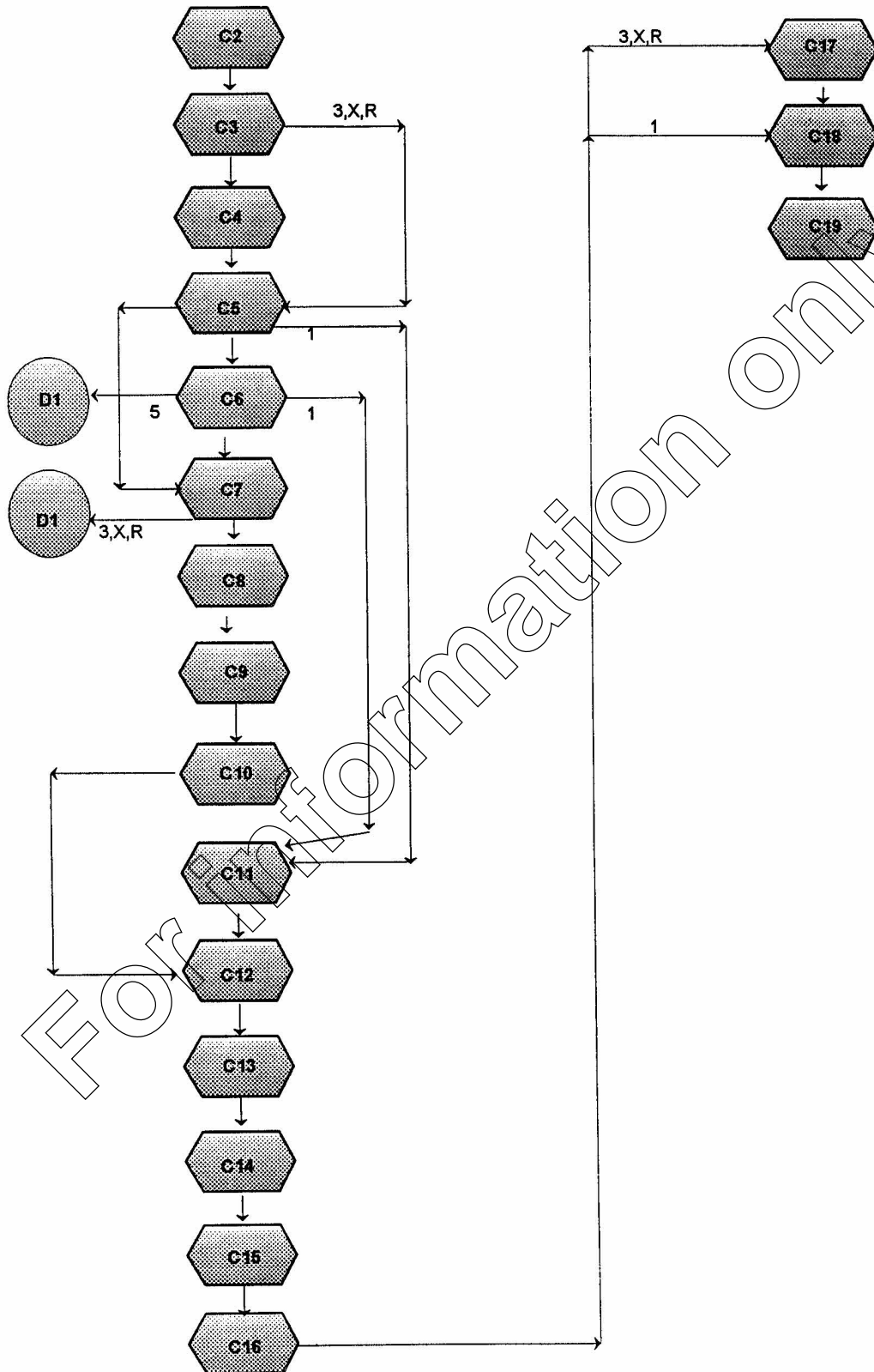

SECTION D: BEFORE EDUCATION

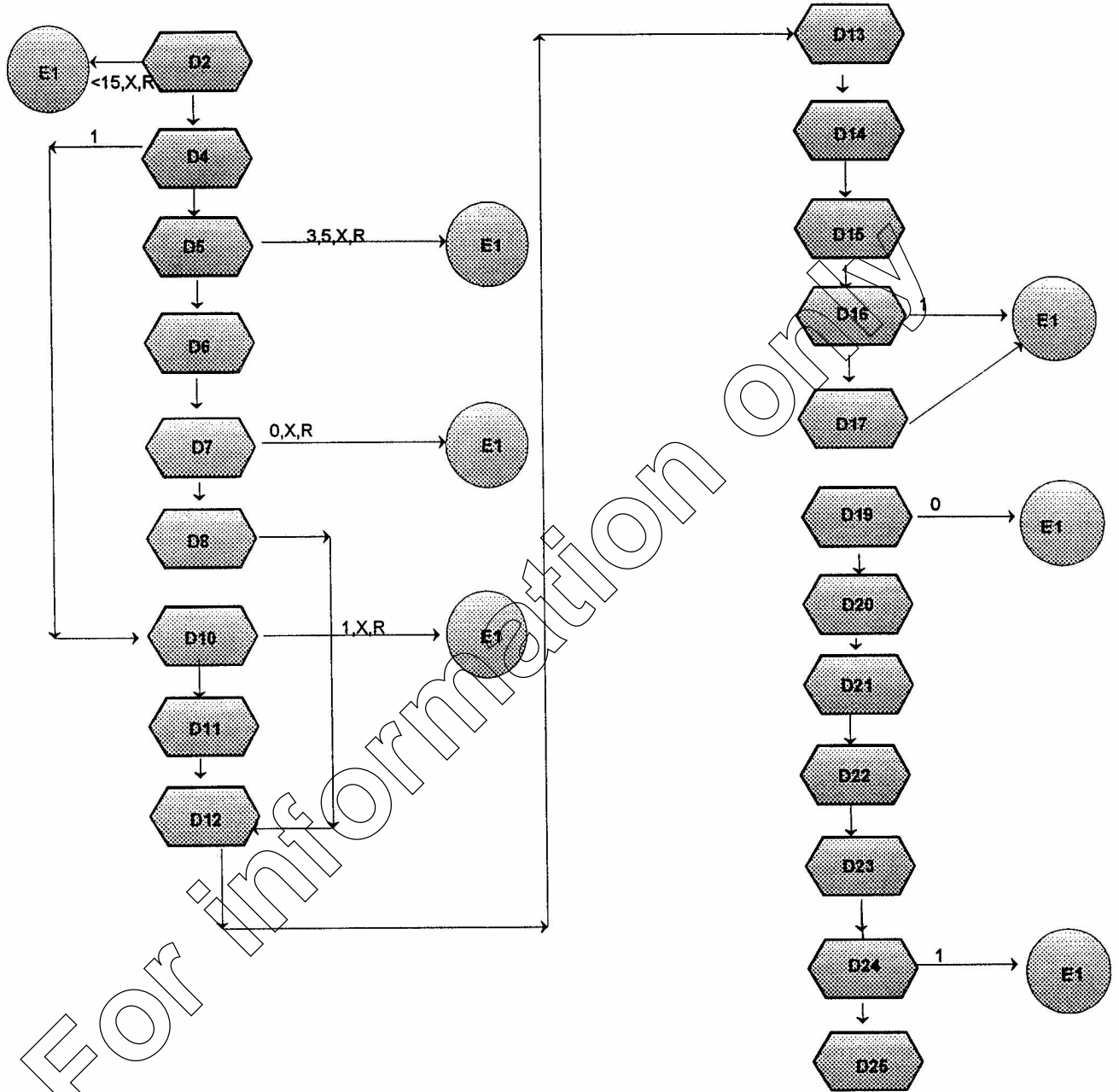

SECTION E: FUTURE EDUCATION

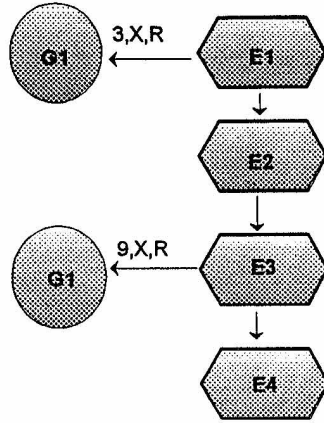

For information only

SECTION G: WORK SCREEN

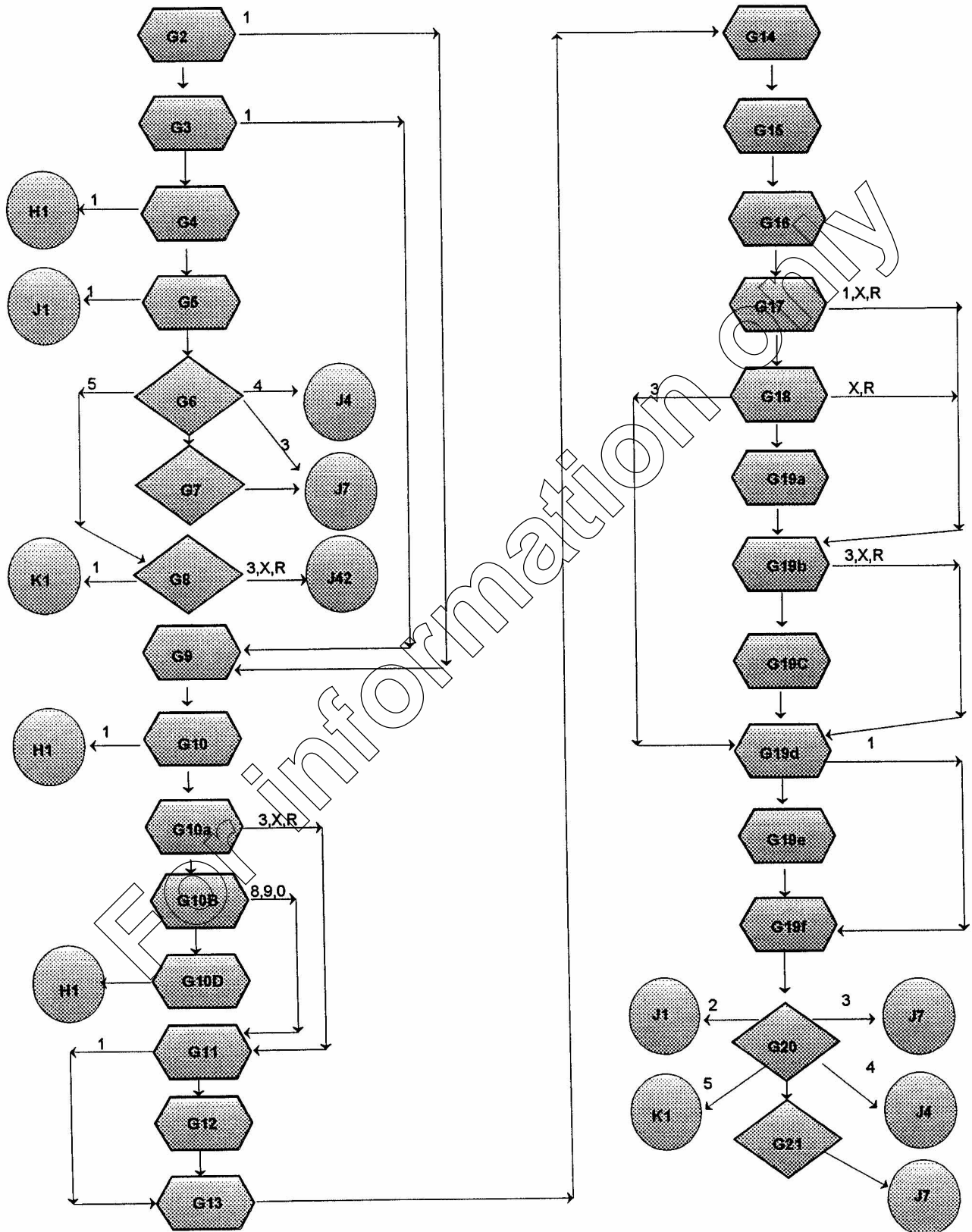

SECTION H: EMPLOYED

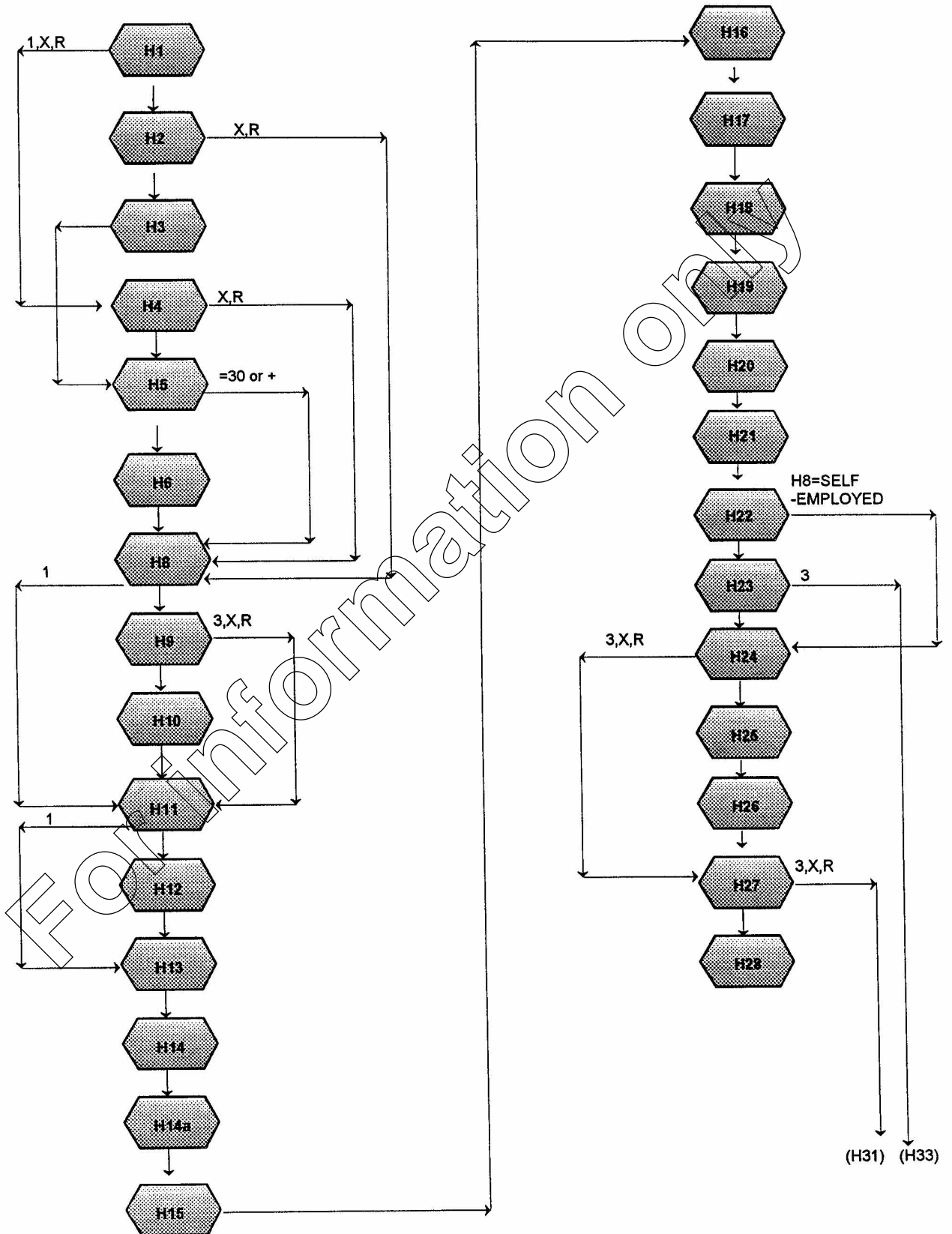

SECTION H: EMPLOYED

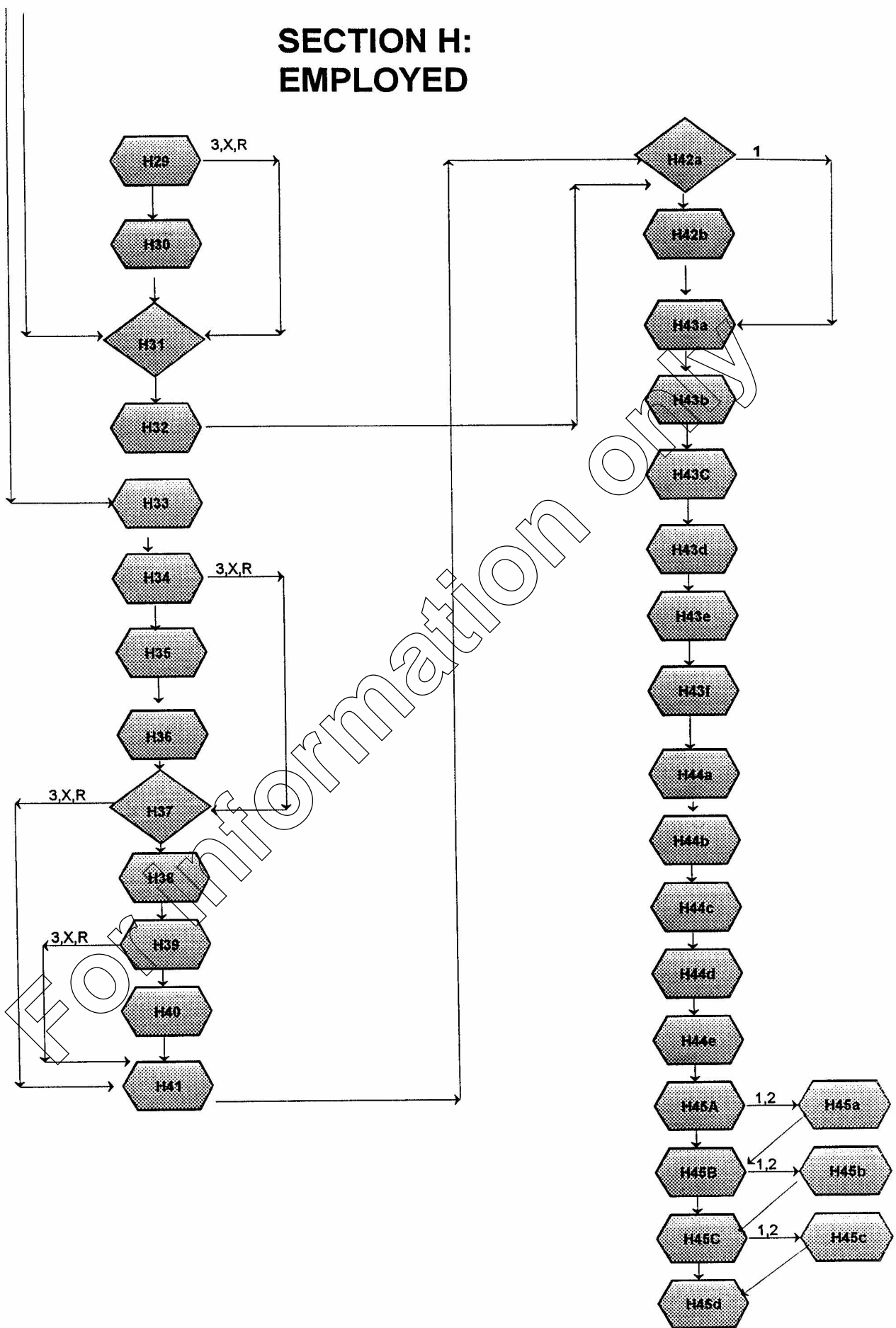

SECTION H: EMPLOYED

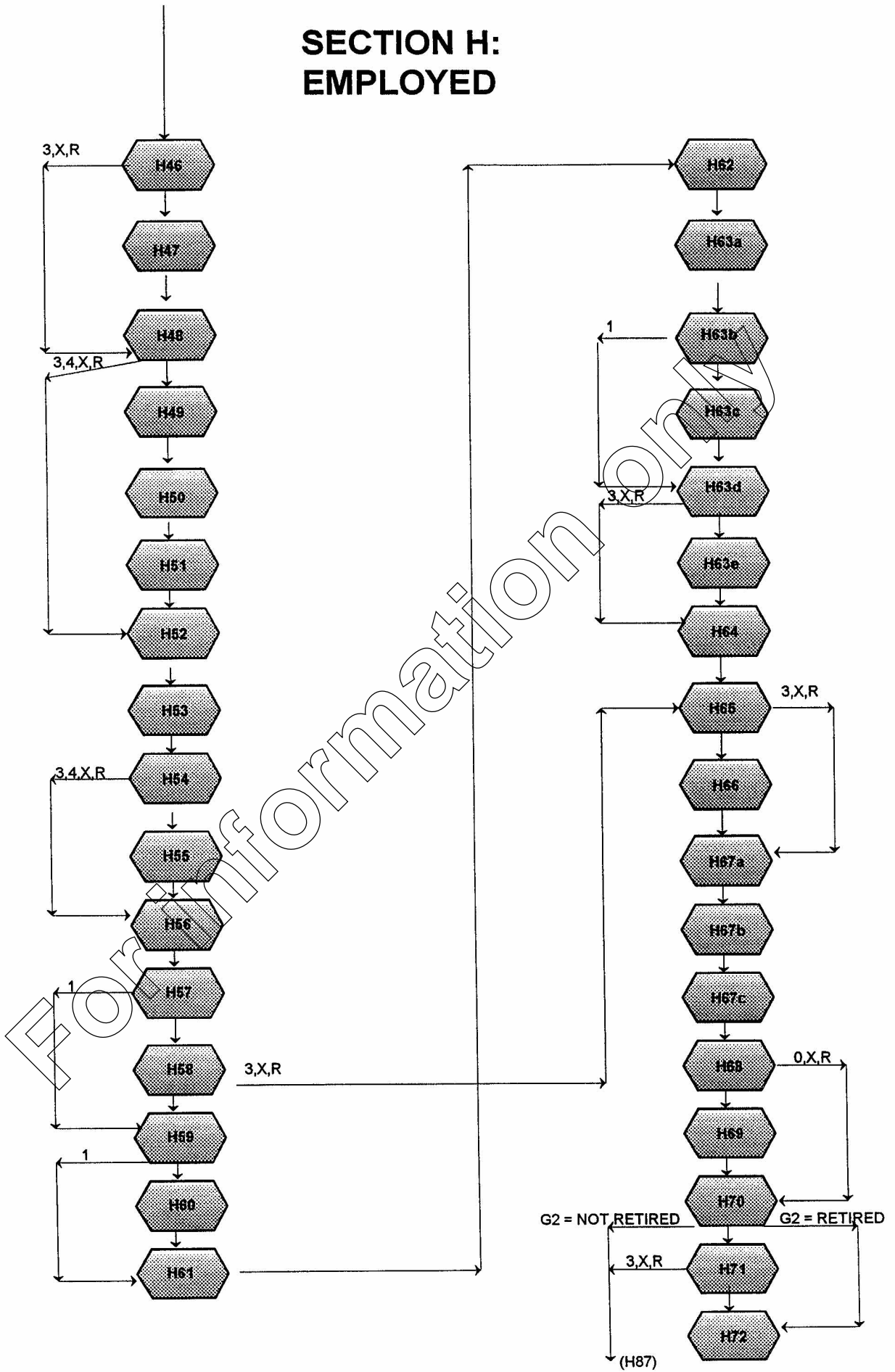

SECTION H: EMPLOYED

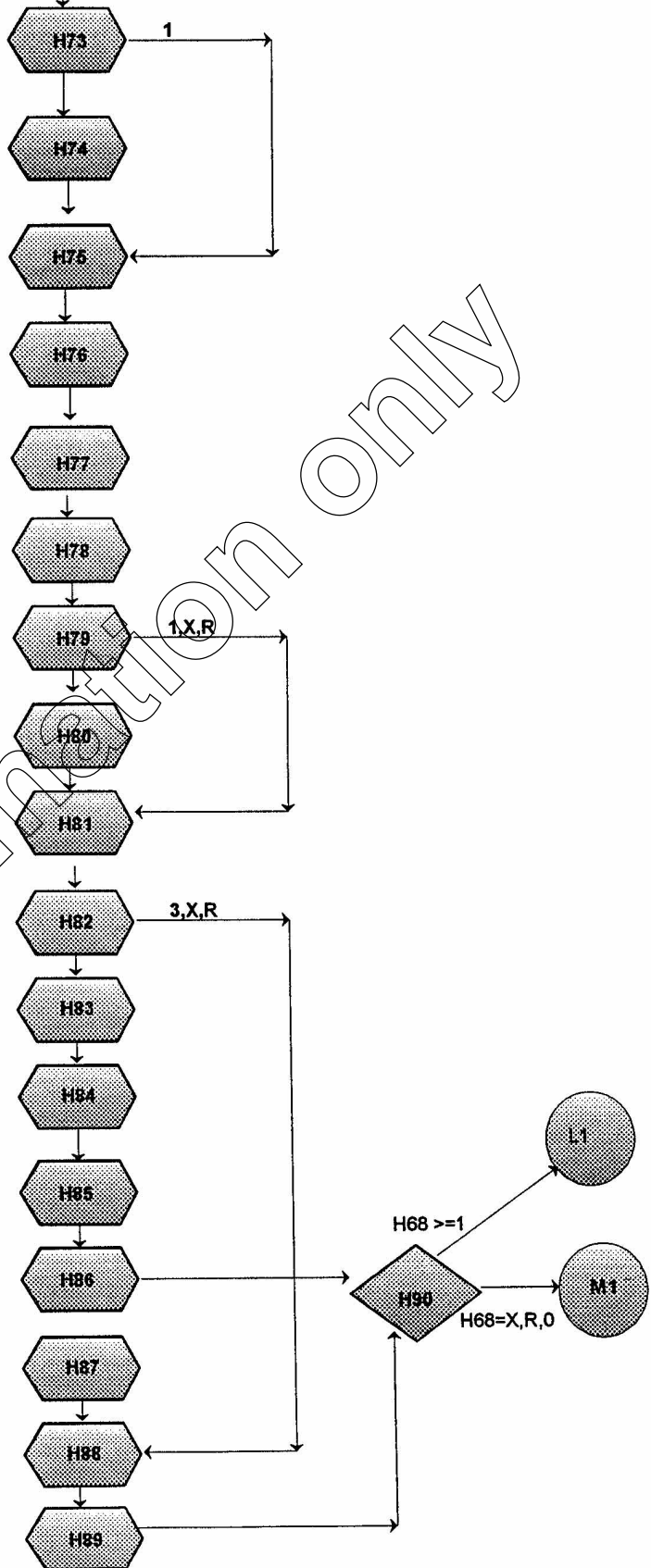

SECTION J: PERSONS NOT EMPLOYED

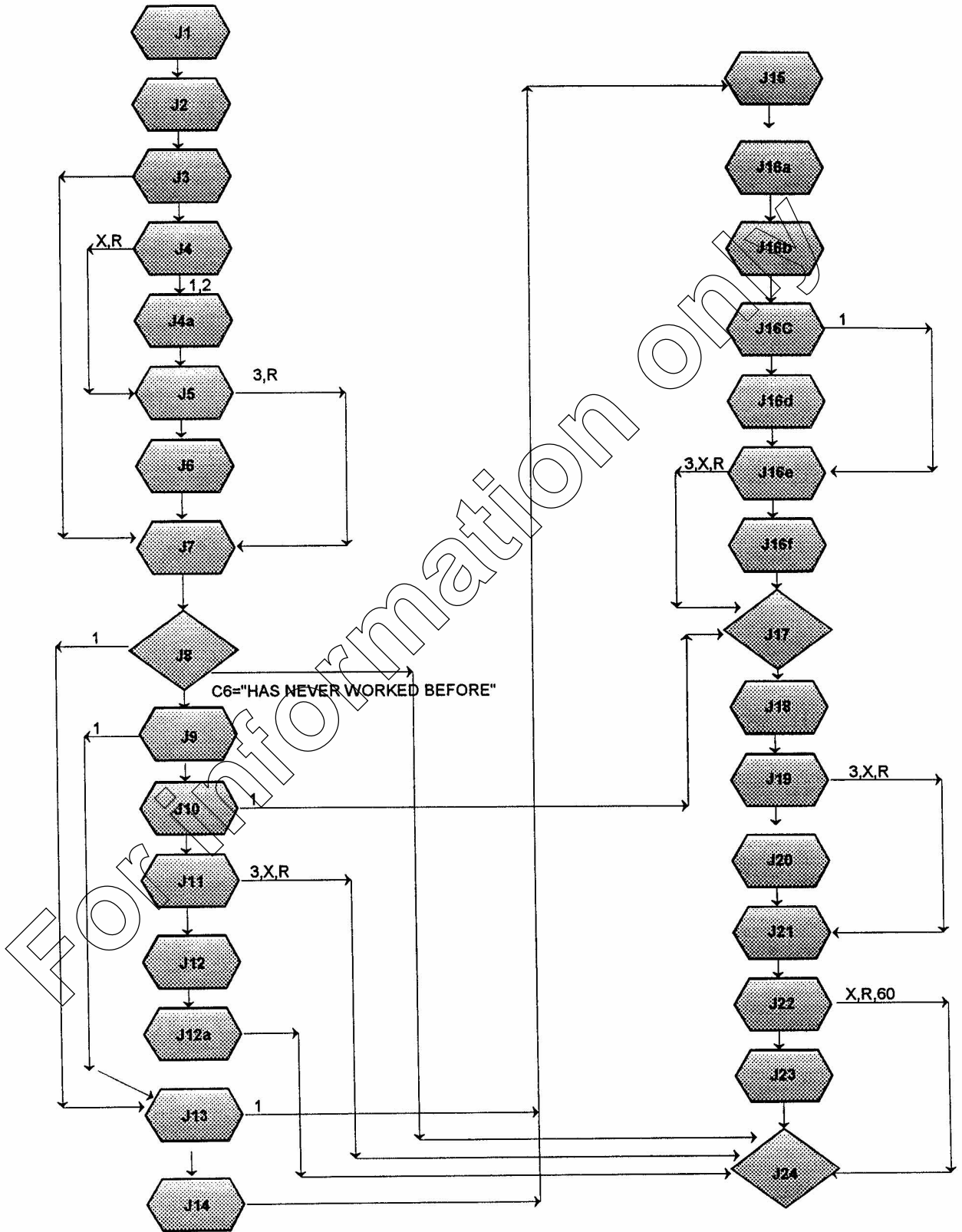

SECTION J: PERSONS NOT EMPLOYED

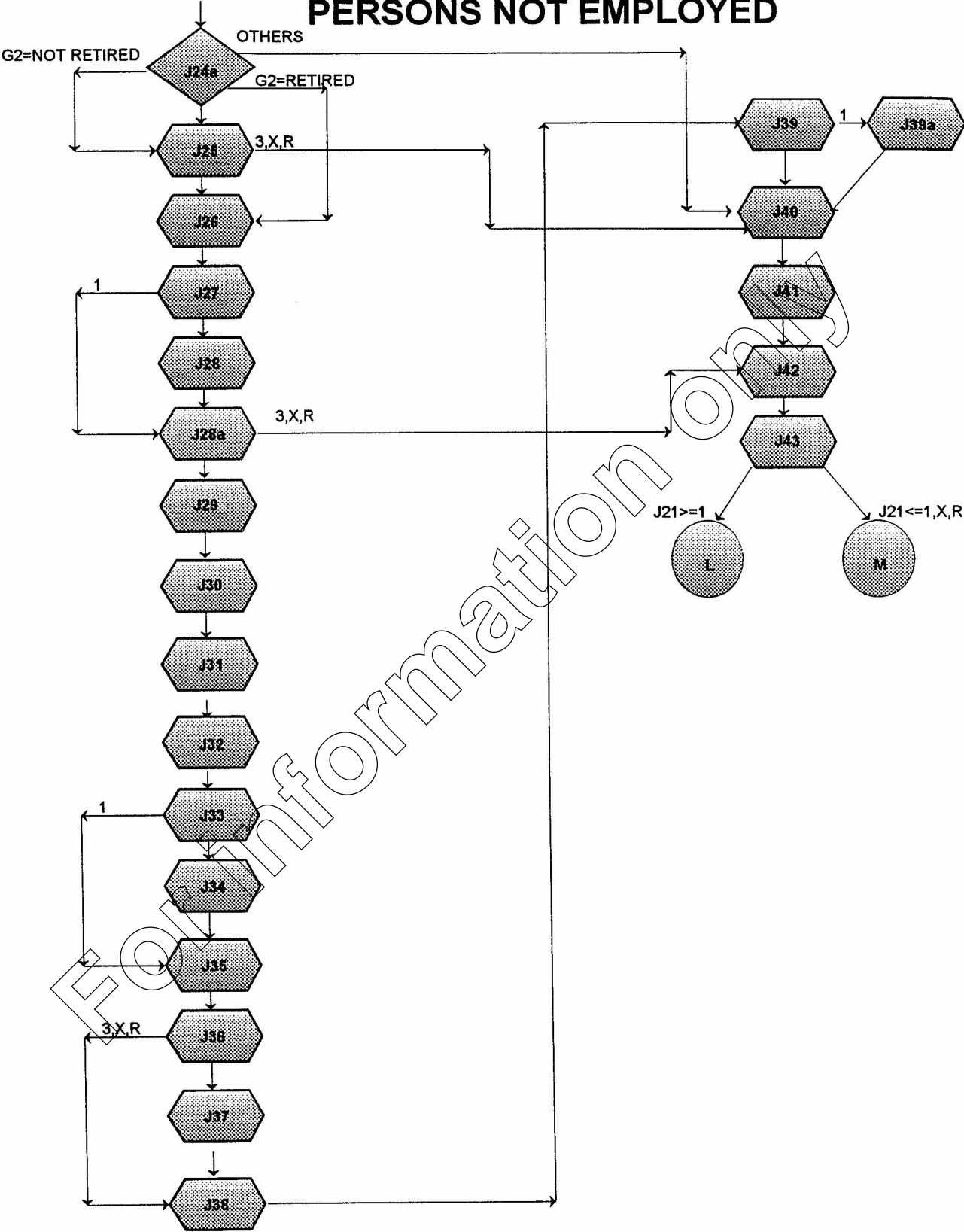

SECTION K: RETIRED

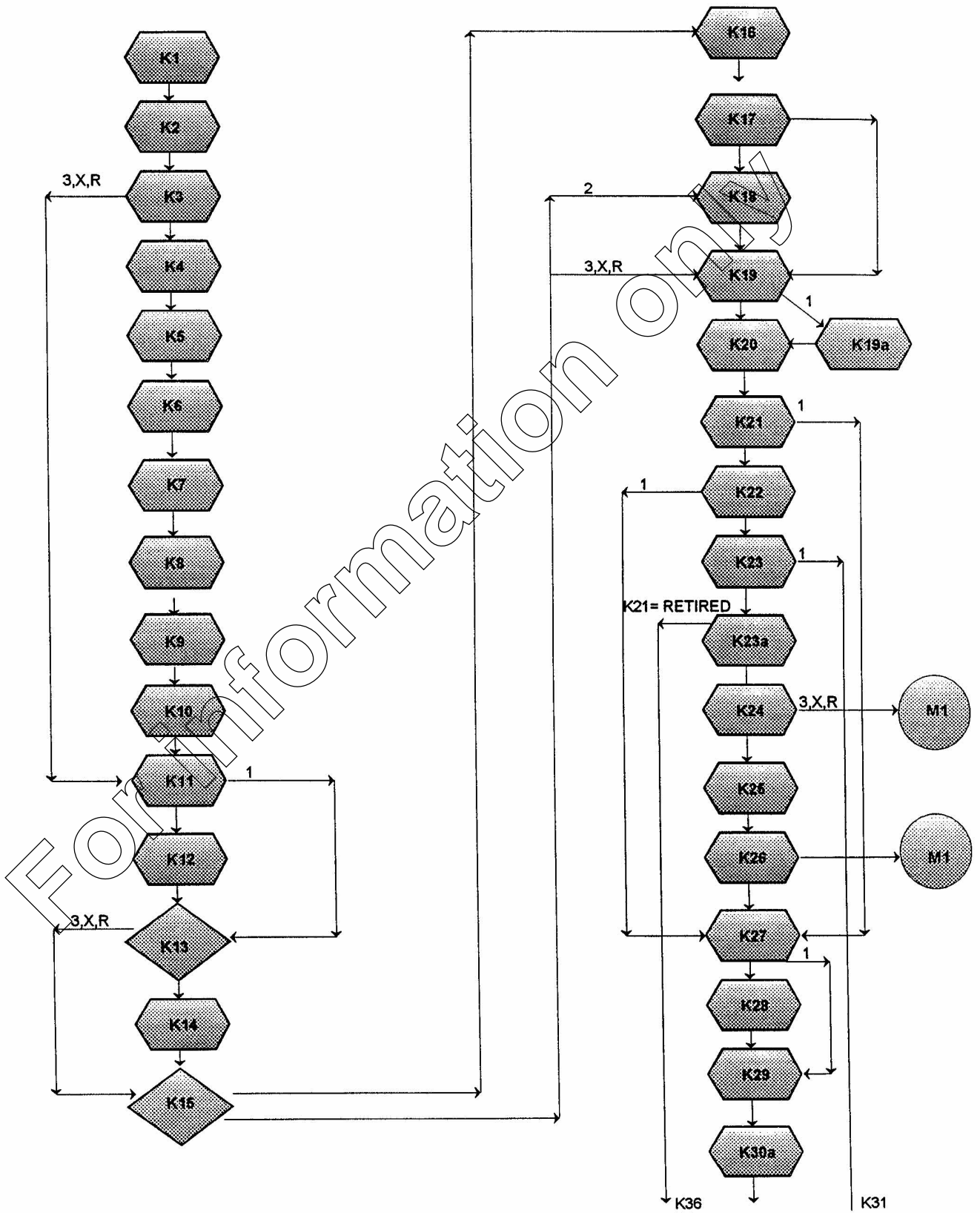

SECTION K: RETIRED

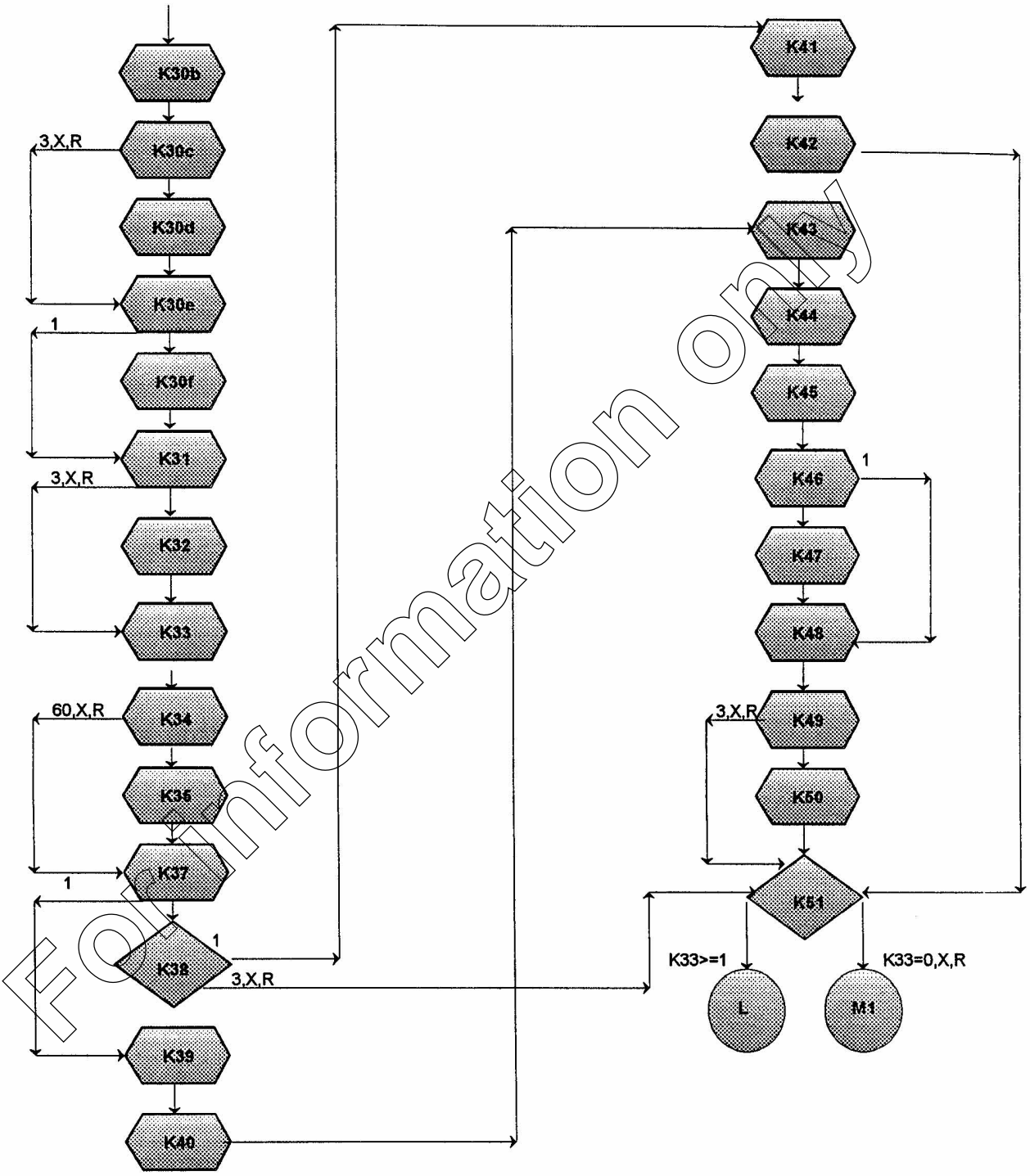

SECTION L: WORK INTERRUPTIONS

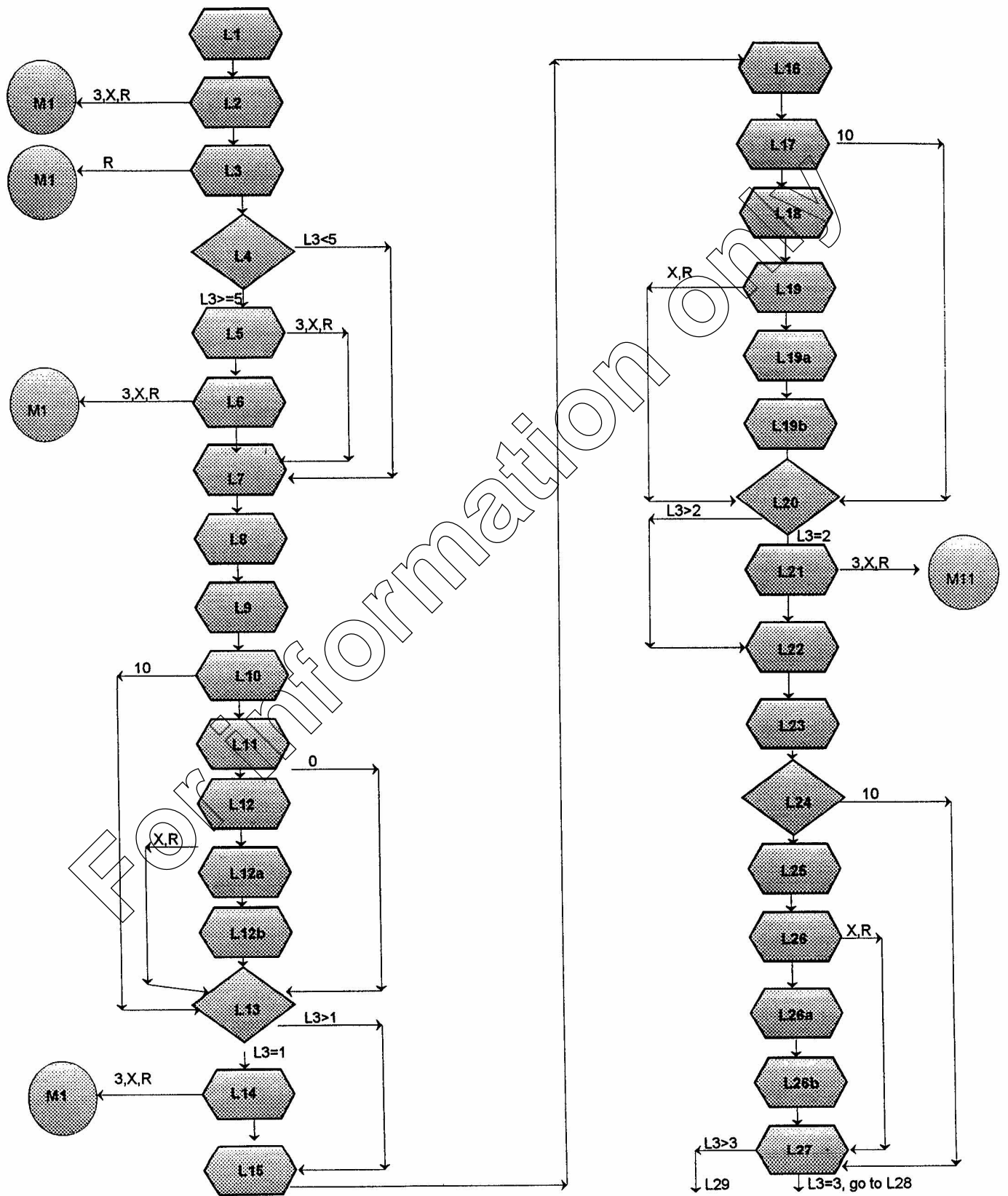

SECTION L: WORK INTERRUPTIONS

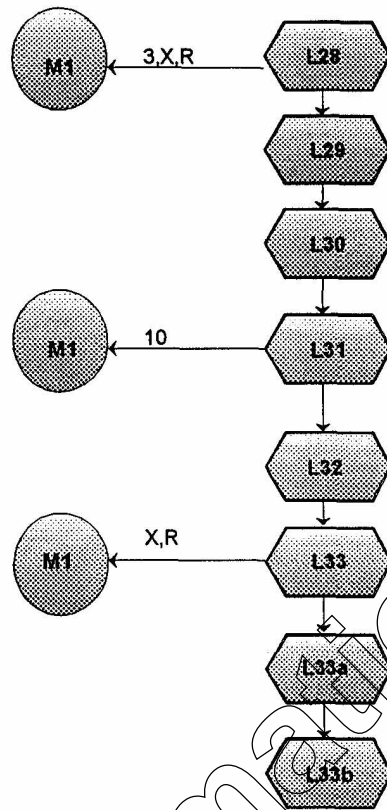

For information only

SECTION M: SOCIAL ORIGIN

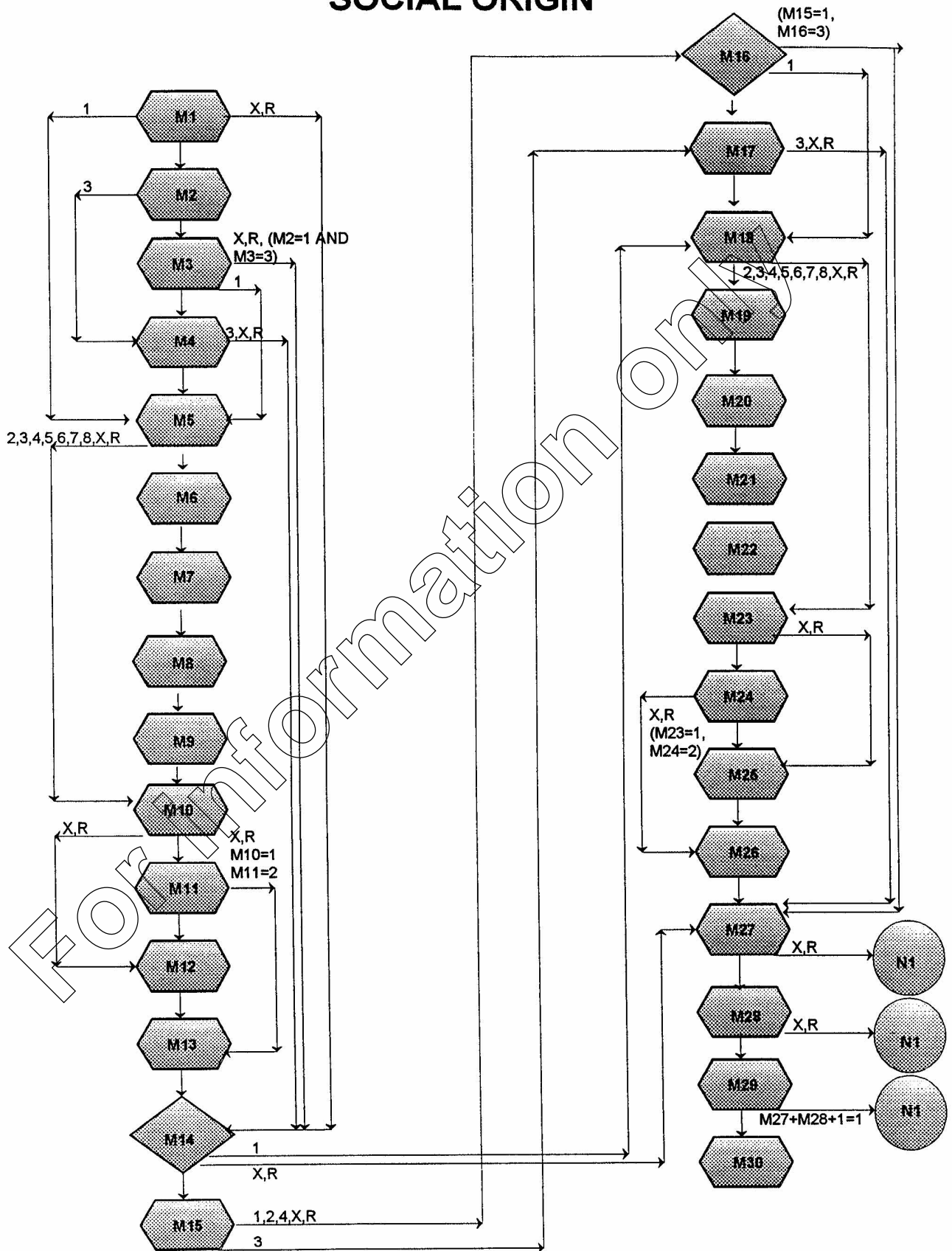

SECTION N COMPUTER USE AND RELATED MATERIAL

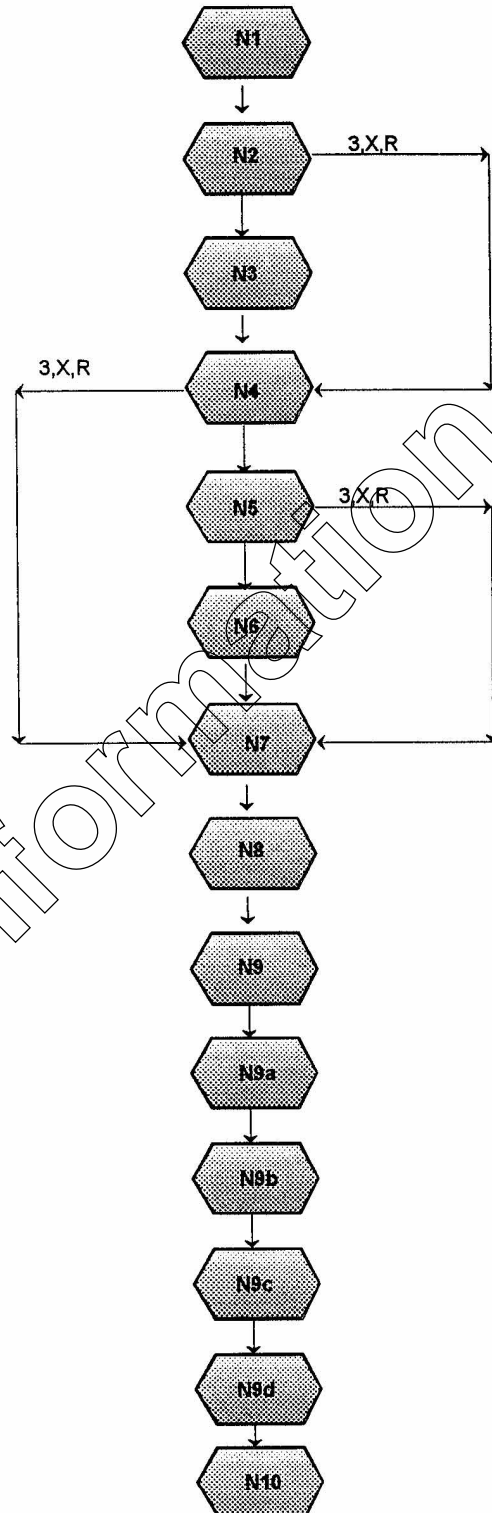

SECTION P: OTHER CLASSIFICATION

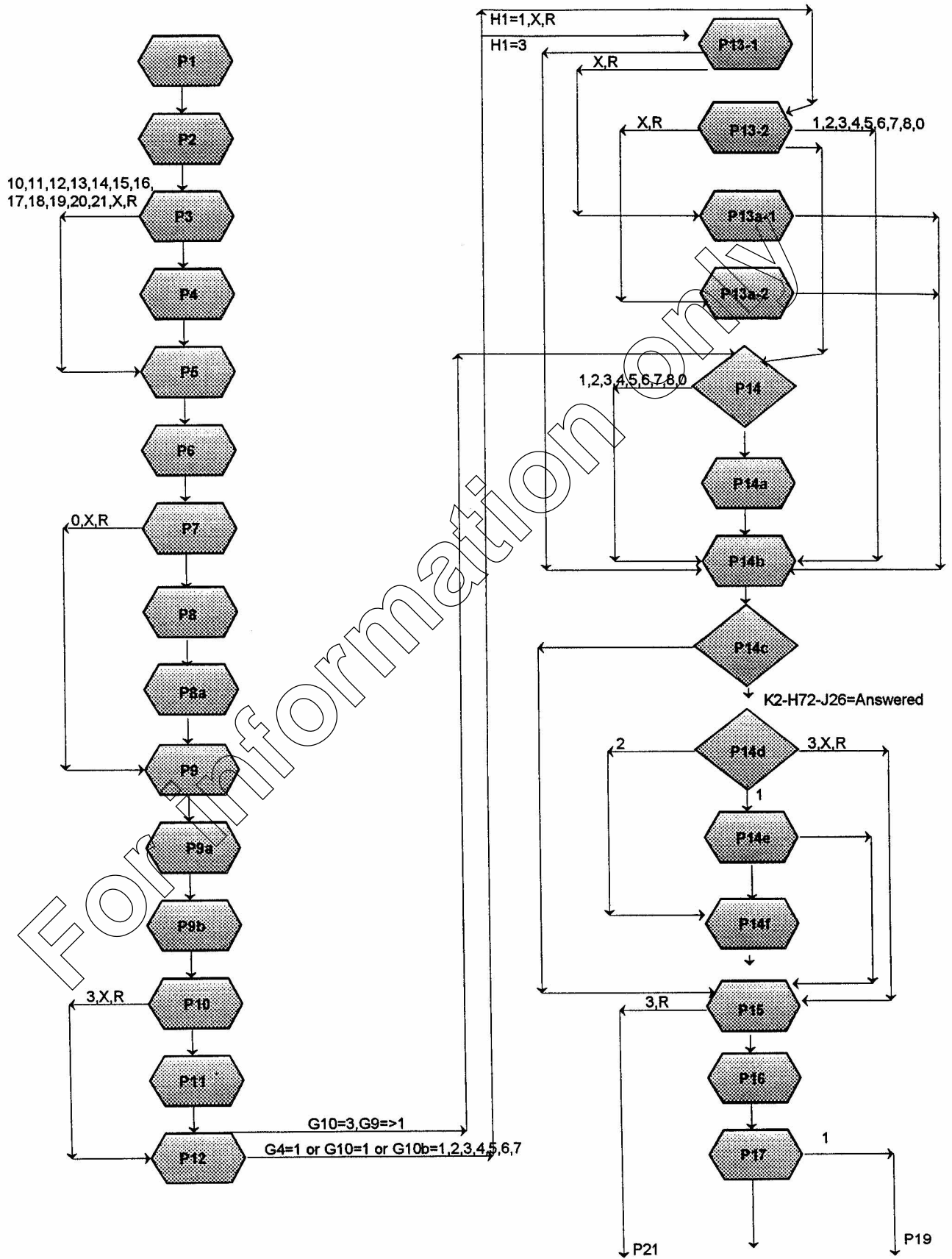

SECTION P: OTHER CLASSIFICATION

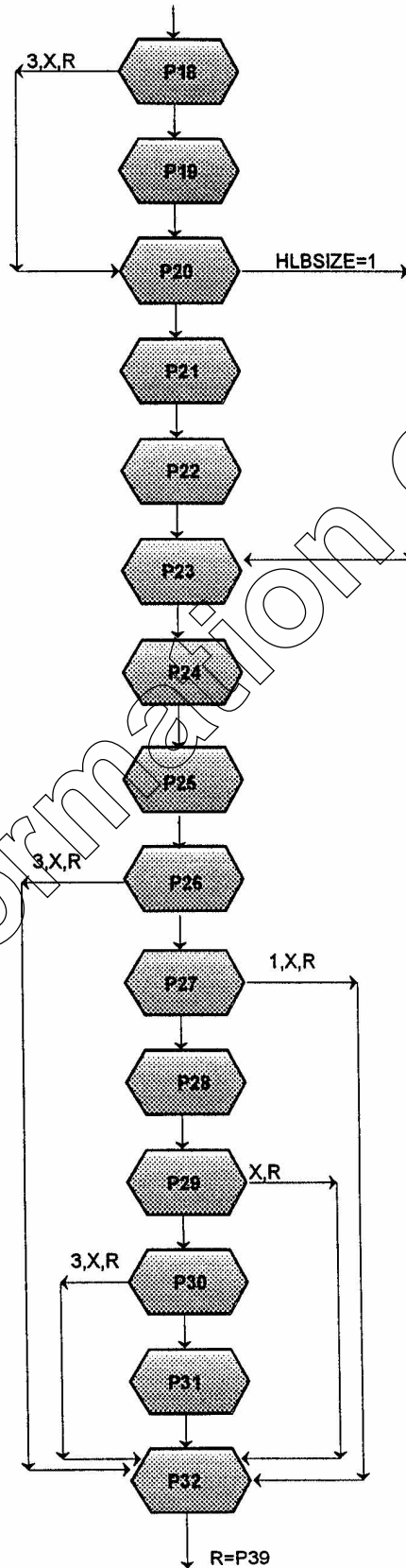

SECTION P: OTHER CLASSIFICATION

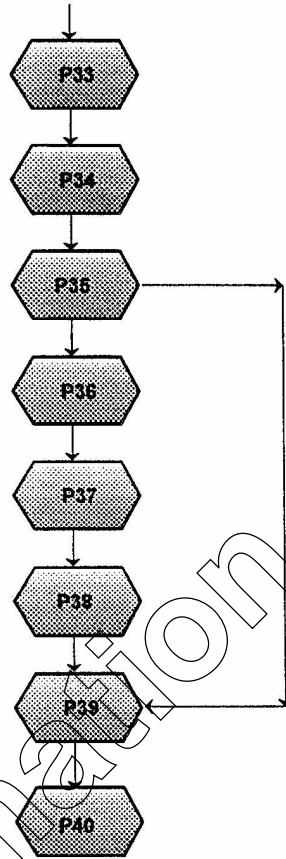

For information only