



CNSC Fukushima Task Force Report

INFO-0824

October 2011



CNSC Fukushima Task Force Report

© Minister of Public Works and Government Services Canada 2011
Catalogue number CC172-77/2011E-PDF
ISBN 978-1-100-19497-4

Published by the Canadian Nuclear Safety Commission (CNSC)
Catalogue number INFO-0824

Extracts from this document may be reproduced for individual use without permission provided the source is fully acknowledged. However, reproduction in whole or in part for other purposes requires prior written permission from the Canadian Nuclear Safety Commission.

Également publié en français sous le titre de : *Rapport du Groupe de travail de la CCSN sur Fukushima*

Document availability

This document can be viewed on the CNSC Web site at nuclearsafety.gc.ca. To order a printed copy of the document in English or French, please contact:

Canadian Nuclear Safety Commission
280 Slater Street
P.O. Box 1046, Station B
Ottawa, Ontario K1P 5S9
CANADA

Tel.: 613-995-5894 or 1-800-668-5284 (in Canada only)

Facsimile: 613-995-5086

E-mail: info@cnsccsn.gc.ca

Web site: nuclearsafety.gc.ca

CNSC Fukushima Task Force Report

INFO-0824

October 2011

Preface

The CNSC Fukushima Task Force was established under the authority of the Executive Vice-President and Chief Regulatory Operations Officer, Ramzi Jammal, to evaluate operational, technical and regulatory implications on Canadian nuclear power plants (NPPs) from the 2011 nuclear event in Fukushima, Japan.

The work of the Task Force was led by Dr. Greg Rzentkowski, Director General of the Directorate of Power Reactor Regulation, who is responsible for implementing regulatory actions, including policy decisions, regulatory requirements and recommendations for safety upgrades at Canadian NPPs.

Acknowledgements

The CNSC Fukushima Task Force was made up of the following members, supported by many other CNSC staff in a wide range of disciplines.

Chair:

Greg Rzentkowski Director General, Directorate of Power Reactor Regulation

Vice-Chair:

Gerry Frappier Director General, Directorate of Assessment and Analysis

Technical Leads:

Tom Schaubel Director, Directorate of Power Reactor Regulation

Phil Webster Director, Directorate of Power Reactor Regulation

Pat Hawley Director, Directorate of Assessment and Analysis

Scientific Secretary:

Hatem Khouaja Technical Advisor, Directorate of Power Reactor Regulation

Project Management:

Albert Thibert Senior Regulatory Program Officer, Directorate of Power Reactor Regulation

Technical Specialists:

Sanja Simic Technical Specialist, Directorate of Assessment and Analysis (severe accidents)

David Newland Director, Directorate of Regulatory Improvement and Major Projects (requirements for new builds)

Chantal Morin Technical Specialist, Directorate of Assessment and Analysis (probabilistic safety assessment)

Chris Harwood Technical Specialist, Directorate of Assessment and Analysis (deterministic safety analysis)

Luc Sigouin Director, Directorate of Security and Safeguards (emergency response)

The CNSC Task Force wishes to thank the numerous CNSC staff members who provided expert advice and timely assistance to the Task Force members.

Executive Summary

On March 11, 2011, a magnitude 9.0 earthquake, followed by a devastating tsunami, struck Japan. It left an estimated 25,000 people dead or missing, about half a million homes destroyed or damaged, and 560 square kilometres inundated.

The combined impact of the earthquake and tsunami on the Fukushima Daiichi nuclear power plant (NPP) caused one of the world's worst-ever nuclear accidents. In the hours and days that followed, three of the plant's six reactors overheated and suffered damage. Workers battled extraordinary conditions to prevent or delay radioactive releases over the surrounding region and into the sea. It is a tribute to their efforts that releases were delayed sufficiently to enable the nearby population to be evacuated despite widespread damage to the local infrastructure.

As the accident unfolded, the evacuation zone was expanded and people in a wider area were asked to shelter indoors. Widespread radiation monitoring and control of food production and distribution were implemented. The Japanese government has indicated that some areas may remain uninhabitable for many years. Similarly, monitoring and control of food and water supplies will need to be maintained, perhaps for many years. The emergency response measures currently in place have prevented fatalities from radioactive releases and should ensure that any long-term health effects for the Japanese public are negligible.

Immediate actions taken by the Canadian Nuclear Safety Commission

While major accidents such as this happen very infrequently, it is vitally important that all nuclear facility designers and operators, nuclear regulators, and emergency response organizations learn every possible lesson. The Canadian Nuclear Safety Commission (CNSC) has always endeavoured to continuously improve both itself and the safety performance of the nuclear industry that it regulates. It is in this spirit that the CNSC responded immediately to the accident at Fukushima Daiichi with the following actions:

- activated its Emergency Operations Centre in Ottawa and staffed it 24/7 to monitor the emergency, assess early reports and provide timely, accurate information to Canadians and to other Canadian government departments and agencies
- requested licensees of Canadian Class I nuclear facilities¹, under section 12(2) of the *General Nuclear Safety and Control Regulations*, to review the lessons learned from the Fukushima Daiichi accident
- performed inspections of all NPPs and other nuclear facilities in Canada to assess the readiness of mitigating systems – these inspections covered seismic preparedness, firefighting capability, backup power sources, hydrogen mitigation and irradiated fuel bay cooling
- established a Task Force to evaluate the operational, technical and regulatory implications of the accident and the adequacy of emergency preparedness for NPPs

The CNSC Fukushima Task Force was created with the objective of reviewing the capability of NPPs in Canada to withstand conditions similar to those that triggered the Fukushima accident. Specifically, the CNSC Task Force examined the response of NPPs to external events of higher magnitude than have previously been considered. It also examined the licensees' capability to respond to such events. The focus was on the need to "anticipate the unexpected": events such as earthquakes, tornadoes or hurricanes that may cause a prolonged loss of electrical power, resulting in operators not being able to continue cooling the reactors. The focus was also on the need for an integrated response capability.

¹ Class I nuclear facilities are defined in the *Class I Nuclear Facilities Regulations* and include nuclear power plants, research reactors and fuel fabrication facilities.

Safety review criteria

The scope of the review, documented in *Nuclear Power Plant Safety Review Criteria*, was consistent with the defence-in-depth approach underlying the NPP design, namely:

- identification and magnitudes of external events
- adequacy of design-basis-accident analysis
- consideration of beyond-design-basis accidents
- implementation of severe accident management
- licensees' emergency response plans
- nuclear emergency management in Canada
- CNSC regulatory framework and processes

The defence-in-depth strategy assures prevention and control of events and accidents at several engineering and procedural levels in order to ensure the effectiveness of the protection of physical barriers against the release of radioactive materials. In principle, if a failure were to occur, it would be detected and compensated for, or corrected, by appropriate measures to maintain protection of the public.

The *Nuclear Power Plant Safety Review Criteria* generally exceed the requirements and expectations of the current CNSC regulatory framework. The CNSC Task Force review findings relate exclusively to the lessons learned from the Fukushima accident.

In the process of formulating the safety review criteria, the CNSC Task Force considered all the applicable lessons learned to date from the Fukushima accident and reviewed selected international reports to ensure that all aspects relevant to Canada were addressed. Effectively, the CNSC Task Force has subjected the Canadian NPPs, the existing emergency response measures, and the regulatory framework and supporting processes to a systematic and comprehensive “stress test” to evaluate means to further protect the health and safety of Canadians and the environment. The post-Fukushima review has examined events more severe than those that have historically been regarded as credible and their impact on the NPPs. The CNSC Task Force has proposed changes to designs or procedures, wherever gaps were found, in order to minimize or eliminate their impact.

Strengthening reactor defence in depth

Based on the post-Fukushima review, the CNSC Task Force confirms that the Canadian NPPs are robust and have a strong design relying on multiple layers of defence. The design ensures that there will be no impact on the public from external events that are regarded as credible. The design also offers protection against more severe external events that are much less likely to occur.

Nevertheless, the CNSC Task Force has a number of recommendations for strengthening each layer of defence built into the Canadian NPP design and licensing philosophy. In particular, the CNSC Task Force recommends that certain design enhancements for severe accident management – such as containment performance to prevent unfiltered releases of radioactive products, control capabilities for hydrogen and other combustible gases, and adequacy and survivability of equipment and instrumentation – should be evaluated and implemented wherever practicable. Some of these enhancements have already been implemented and others should be implemented as rapidly as practicable.

Enhancing emergency response

The CNSC Task Force also confirms that the current status of emergency preparedness and response measures in Canada, specifically the onsite and offsite preparedness and response, is adequate. The CNSC Task Force has verified that there are no significant gaps in emergency planning at Canadian NPPs. The licensees maintain and operate comprehensive and well-documented emergency plans which are regularly tested through self-audited drills and exercises. The CNSC Task Force has also verified that there are no

significant gaps in nuclear emergency planning at provincial and federal levels. The existing provincial and federal emergency plans are well documented and effectively integrated with onsite emergency preparedness and response measures.

Notwithstanding these measures, their effectiveness can be further improved through upgrading onsite emergency facilities and equipment, in particular through formalizing all arrangements and agreements for external support and installing automated real-time station boundary radiation monitoring systems with appropriate backup power. Federal and provincial nuclear emergency planning could be strengthened through establishing a formal, transparent, national-level oversight process for offsite nuclear emergency plans, programs and performance, and through scheduling of regularly planned full-scale exercises.

Improving regulatory framework and licensing

The CNSC Task Force has performed a detailed review of the CNSC regulatory framework and processes, and concludes that the *Nuclear Safety and Control Act* does not need revision and that there is no need to revisit the structure of the regulatory framework as a result of the lessons learned from the Fukushima Daiichi accident. The Canadian regulatory framework is strong and comprehensive and is effectively applied for the whole range of plant conditions, including severe accidents. In particular, the CNSC Task Force notes that the Act authorizes the Commission to establish classes of licences and that the CNSC has the authority and flexibility to rapidly amend licences to impose additional requirements in order to continuously improve the safety performance of the nuclear industry. This is regarded as a strength of the Canadian system.

Nevertheless, to widen the range of instruments allowing for an effective application of the Act, the CNSC Task Force recommends that the *Class I Nuclear Facilities Regulations* be amended to require licensees to submit offsite emergency plans. It also recommends that the *Radiation Protection Regulations* be amended to be more consistent with international guidance and to describe the regulatory requirements needed to address radiological hazards during the phases of an emergency in greater detail. Furthermore, the CNSC Task Force recommends enhancing the oversight of NPPs by implementing a periodic safety review process.

The regulatory document framework should be enhanced by updating selected requirements and expectations for design-basis and beyond-design-basis accidents. These updates will ensure that lessons learned are built into the regulatory oversight program for existing reactors and new builds.

Overall conclusion

The CNSC Task Force concludes that Canadian NPPs are safe and that the risk posed to the health and safety of Canadians or to the environment is small. The CNSC staff have also verified that all Canadian NPPs are located far from tectonic plate boundaries and that the threat of a major earthquake at a Canadian NPP is negligible. The CNSC Task Force is confident that the improvements recommended in this report will further enhance the safety of nuclear power in Canada and will reduce the associated risk to as low as reasonably practicable.

Under the oversight of the CNSC and its staff, Canadian NPPs have been operating safely for over 40 years. As has always been the case, they will only be licensed if the CNSC is satisfied that they will continue to be operated safely.

Table of Contents

Preface	i
Acknowledgements.....	ii
Executive Summary	iii
1 Background.....	1
2 Summary of the Accident.....	2
2.1 Operating units	3
2.2 Spent fuel storage	6
2.3 Offsite consequences	6
3 Initial CNSC Response.....	9
3.1 Activation of the CNSC Emergency Operations Centre	9
3.2 Regulatory request to licensees	10
3.3 CNSC inspections of Canadian nuclear power plants	10
3.4 The CNSC Task Force	11
4 International Response	12
4.1 Review of terms of reference of international task forces.....	12
4.2 Early results of other international task forces	13
5 Comparison of Canadian and Japanese External Hazards.....	17
5.1 Canadian tsunami hazard profile	17
5.2 Canadian seismic hazard map	19
5.3 Other external hazards.....	20
6 Safety Review of Canadian Nuclear Power Plants.....	20
6.1 External hazards	21
6.2 Design-basis accidents	23
6.3 Beyond-design-basis accidents.....	25
6.4 Severe accident management	30
6.5 Emergency response.....	35
7 Nuclear Emergency Management in Canada	40
7.1 Nuclear power plant licensees	41
7.2 Government of Canada.....	42
7.3 Provincial governments.....	44
7.4 International stakeholders.....	50
7.5 Review findings for nuclear emergency management in Canada	52
8 The CNSC Regulatory Framework and Processes	53
8.1 Act and regulations.....	53
8.2 Licences, licence conditions and orders	54
8.3 Regulatory and guidance documents.....	55
8.4 Other parts of the regulatory framework	56
8.5 Compliance.....	56
8.6 Processes	56
8.7 Review findings for the regulatory framework and processes	56
9 Implications for New Builds.....	57
10 Conclusions and Recommendations.....	59
10.1 Strengthening reactor defence in depth	60

10.2	Enhancing emergency response	61
10.3	Improving regulatory framework and processes	61
Glossary	63
References	68
Appendix A	CANDU Overview	71
Appendix B	Progression of a Loss of Heat Sink Accident	81
B.1	Secondary boil-down.....	81
B.2	Primary boil-down.....	81
B.3	Moderator boil-down.....	82
B.4	Shield tank / calandria vault boil-down.....	82
B.5	Shield tank / calandria vault failure.....	82
Appendix C	CNSC Emergency Operations Centre Lessons Learned.....	83
C.1	Background	83
C.2	Methodology	83
C.3	Key observations	84
C.4	Conclusion.....	84
Appendix D	Correspondence of Report Recommendations to Detailed Findings	85

1 Background

On March 11, a magnitude 9.0 earthquake² struck off the northeast coast of Japan's main island. A devastating tsunami followed. The earthquake and tsunami left an estimated 25,000 people dead or missing, about half a million homes destroyed or damaged and 560 square kilometres of land inundated.

The combined impact of the earthquake and tsunami on the Fukushima Daiichi nuclear power plant (NPP) caused one of the worst-ever nuclear accidents. In the hours and days that followed, the cores of three of the six reactors at the site melted down and released radioactive material over the surrounding region and to the sea.

The Japanese authorities initially rated the nuclear accident at level 4 on the INES³ scale (International Scale of Nuclear Incidents). They subsequently increased the level to 7, the highest on the scale. A final assessment of the severity and causes of the incident will come only after the conclusion of full investigations, expected to take several years. Nevertheless, enough information is available to begin the lessons-learned process.

One of several actions that the Canadian Nuclear Safety Commission (CNSC) took in response to the accident was to set up a Task Force to investigate the lessons learned from the Fukushima Daiichi accident and their implications for Canada. This report documents the findings and recommendations of the CNSC Fukushima Task Force.

The report provides relevant background information in the following areas:

- a summary of the accident (section 2)
- Canadian and international actions in response to the accident (sections 3 and 4)
- a comparison of Japanese seismic and flooding hazards to Canadian hazards (section 5)

The report summarizes the detailed CNSC Task Force reviews in three main areas:

- capability of Canadian NPPs to withstand extreme external events, including a review of licensees' responses to the CNSC's request for information concerning lessons learned (section 6)
- adequacy of Canada's measures to respond to a major nuclear emergency (section 7)
- adequacy of the Canadian regulatory framework and processes, including findings involving changes to regulatory requirements (section 8)

The implications of the CNSC Task Force findings on potential new reactors in Canada are discussed in section 9. The conclusions and recommendations arising from the review are given in section 10.

Appendix A provides an overview of CANDU (Canadian Deuterium-Uranium) reactors with an emphasis on features important to accidents with loss of electrical power.

² Earthquake magnitudes are measured on the moment magnitude scale (values are very similar to the earlier Richter scale). The scale is based on energy released by the earthquake. An increase in 1 on the scale represents a 32 times increase in energy released.

³ The INES was developed by the International Atomic Energy Agency. More information is available at iaea.org/Publications/Factsheets/English/ines.pdf.

2 Summary of the Accident

On March 11, 2011, at 2:46 p.m. local time, a magnitude 9.0 earthquake struck off the northeastern coast of Japan approximately 175 km from the Fukushima Daiichi plant. This was one of the largest earthquakes in recorded history, moving parts of Japan 3 m east and slightly changing the speed of rotation of the earth. The maximum ground acceleration⁴ at Fukushima Daiichi was 0.56 g, recorded in unit 2, about 25 percent greater than the plant design basis (meaning 25 percent greater than the ground acceleration that the plant was designed to withstand). Figure 2.1 shows the locations of the earthquake epicentre and the NPPs. The Tokyo Electric Power Company (TEPCO) operates the Fukushima Daiichi plant.

Although other reactors on the east coast of Japan were affected by the earthquake and tsunami, only Fukushima Daiichi units 1 to 4 suffered serious damage. This report considers only those units, since sufficient cooling was maintained at all other units.

Figure 2.1 Earthquake Shakemap Showing Nuclear Power Plant Locations

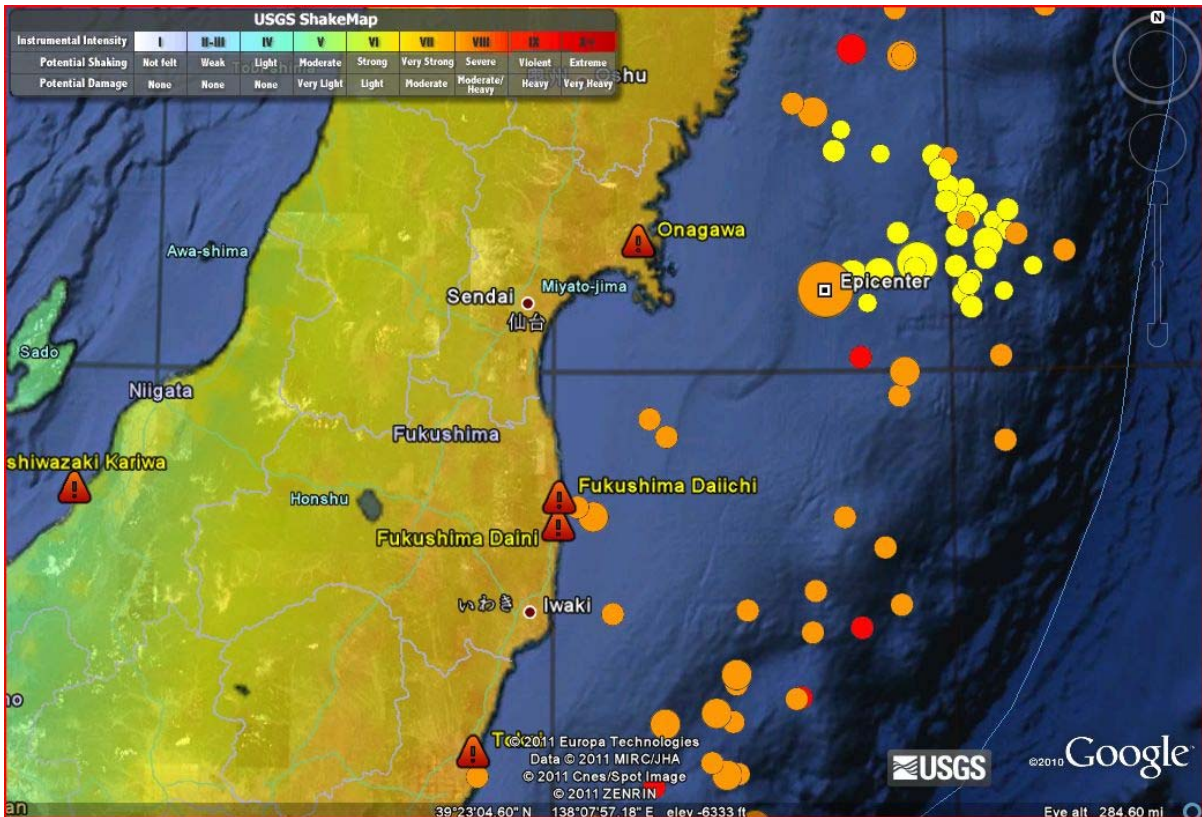

Units 1, 2 and 3 were operating at full power, and units 4, 5 and 6 were already shut down in scheduled maintenance outages. The operating units shut down automatically, as designed, at the time of the earthquake. At the same time, all offsite power was lost; however, emergency diesel generators started automatically as designed and supplied essential electrical equipment.

⁴ Ground acceleration is a measure of the strength of ground motion in an earthquake and is important in understanding the effects on building structures. It is normally given in multiples of the acceleration due to gravity, g. The ground acceleration at a location depends on the magnitude of the earthquake and the distance from the epicentre.

Beginning 41 minutes after the earthquake, a series of tsunami waves hit the station. The tsunami was much higher than had been considered in the plant design and it overwhelmed much of the low-lying equipment. The original station design assumed a maximum tsunami height of 3.1 m, later upgraded to 5.6 m. The highest of the tsunami waves that struck the Fukushima stations was estimated at 14 to 15 m on land. It is important to distinguish between the wave height at sea and the wave height due to run-up on land. The run-up height can be significantly higher than the wave height at sea and is a function of land topography.

Within 54 minutes after the earthquake, the tsunami had stopped all the emergency diesel generators and flooded the electrical switchgear. Units 1 to 4 had two air-cooled emergency diesel generators that escaped the flooding. It is not known if they were operable, but they could not have been used anyway because the electrical switchgear had been flooded. As a result, units 1 to 4 were left with only battery power.

2.1 Operating units

Figure 2.2 shows the general arrangement of a boiling-water reactor of the type used at Fukushima Daiichi.

Figure 2.2 Cutaway View of Boiling-water Reactor Type 1 Containment

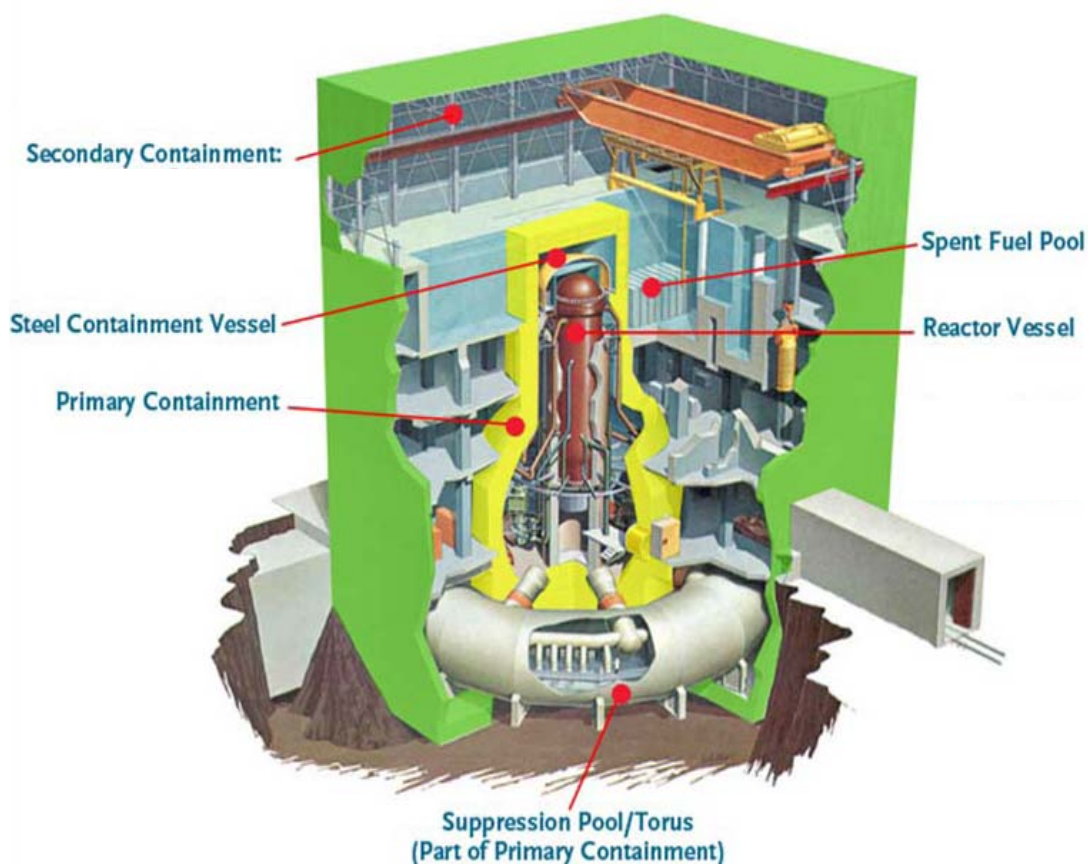

Each unit contains one reactor. The reactor fuel elements are made up of uranium dioxide pellets in a zircaloy tube, about 4 m in length. The fuel elements are arranged in 8×8 bundles and positioned vertically in the reactor core. The reactor core is located low down in the reactor pressure vessel. The

reactor pressure vessel⁵ is inside the steel primary containment which comprises a drywell (inside the yellow boundary shown on the figure) and a suppression pool or wetwell. The wetwell is partly filled with cold water and is used to condense steam from the reactor when it can no longer be sent to the turbine (e.g., after an accident).

Spent fuel from the reactor is stored in the spent fuel pool located at a high elevation inside the secondary containment. The secondary containment does not have pressure retaining capability.

The following description applies generically to each of units 1, 2 and 3 which were operating at the time of the earthquake. The timing of events varied from unit to unit, but the broad progression of events was similar.

After the loss of alternating current (AC) electrical power, pumps driven by steam turbines were used in units 2 and 3 to maintain cooling. These pumps use steam from the reactor as a power source and reject heat to the suppression pool. Continuous cooling of a reactor core must be maintained even after shutdown because the fuel continues to generate heat, known as decay heat⁶. After several hours the batteries were exhausted (or cooling pumps had failed) and all reactor cooling was lost. Unit 1 was a slightly older design and did not have steam-driven pumps. Unit 1 lost cooling almost immediately after the tsunami.

Without adequate cooling, pressure began to rise in each reactor and the reactor pressure vessel relief valves opened to vent⁷ excess steam into the suppression pool located in the containment wetwell. Because steam was being removed from the reactor pressure vessel and not replaced, the reactor began to boil dry.

At some point, the core began to uncover and fuel began to rapidly overheat. As fuel temperatures rose, fuel failures began, first releasing gaseous fission products and progressively the less volatile fission products. When fuel sheath temperatures exceeded 1,200°C, the zircaloy sheath material reaction with steam accelerated significantly to produce zirconium oxide and hydrogen and a large amount of heat. The core began to lose structural strength and melt down⁸.

The atmosphere in the reactor pressure vessel was a mixture of steam, hydrogen and fission products. This mixture was vented to the suppression pool and from there to the primary containment. Because the primary containment was, by design, filled with nitrogen, the hydrogen could not ignite or explode due to lack of oxygen.

The cold water in the suppression pool absorbed the energy of the steam being discharged from the reactor and kept primary containment pressure under control during the initial hours of the accident. But, with no heat removal from primary containment, the suppression pool heated up, becoming progressively less effective. Pressure in the primary containment began to rise. Due to the pressure buildup, the primary containment was at risk of failing and causing an uncontrolled release of radioactive substances. To avoid containment failure, the operator opened valves to vent the primary containment. Hydrogen in the vented gases mixed with air in the secondary containment to form an

⁵ The reactor pressure vessel is a large steel vessel containing the reactor core and filled with reactor coolant.

⁶ Decay heat is produced by the decay of radioactive material in the fuel. For a typical reactor, decay heat falls from about 7 percent immediately after shutdown of the fission reaction to 1 percent after about 5 hours and 0.5 percent after a day.

⁷ Venting is the process of removing unwanted or excess gas from a closed system, either automatically through relief valves or manually through vent valves opened by the operator.

⁸ Zircaloy fuel sheaths melt at about 1,760°C. Fuel pellets melt at about 2,760°C.

explosive mixture, leading to explosions that damaged the secondary containment buildings and possibly other equipment.

Approximate timings of the significant parts of the accident sequence are given in table 2.1.

Table 2.1 Approximate Event Timings (hours)

Event	Unit 1	Unit 2	Unit 3	Notes
Earthquake	0.0	0.0	0.0	Reactors all shut down and stable
Tsunami and loss of AC power	0.9	0.9	0.9	Diesel generators incapacitated by tsunami
Loss of core cooling/make-up	~1.9	70.7	36.0	Units 1 and 3, loss of batteries Unit 2, pump failure
Increase in radiation reading	3.1			Possible start of core overheating
Top of core uncovered	~2.5	~75	~40	From calculations after accident
Fuel melt	~4.5	~77	~42	From calculations after accident
Reactor pressure vessel failure	~10	~109	~66	From calculations after accident
Start of containment venting	~20.0	~44.2	41.9	Data uncertain – conflicting reports
Injection of water begun	24.1	73.8	42.7	Fresh and/or seawater injected to reactor pressure vessels to restore lost inventory
Hydrogen explosion	24.8	87.4	68.3	Units 1 and 3 at reactor service floor Unit 2 inside secondary containment

The above data is based on information from the *Report of the Japanese Government to the IAEA Ministerial Conference on Nuclear Safety* [1] and augmented by other sources. Timings are given in hours from the time of the earthquake. Timings of some events are uncertain; however, this sequence of events is thought to be broadly correct.

The time of the start of core damage is quite uncertain. However, the large-scale production of hydrogen clearly indicates that core dryout and subsequent damage on unit 1 occurred within 24 hours of the earthquake. The start of core damage for units 2 and 3 appears to have been considerably later. Efforts to restore cooling with seawater likely were partially successful in delaying and reducing the extent of core damage and reactor pressure vessel failure.

Approximately 48 hours after the earthquake, high radiation readings forced the operating staff to evacuate from the main control room. Thereafter, they were able to enter the control room for only short periods.

After the initial days of the accident, in which the damage escalated and the utility struggled to regain control, a long period of gradual recovery followed. Electrical and water supplies were slowly restored. However, high radiation levels and widespread damage impeded work. Venting of gases continued periodically to prevent containment from overpressurizing. Highly radioactive water accumulated in low-lying rooms and leaked, or was discharged into the Pacific Ocean.

The damaged reactors are now being cooled by injections of water recovered from the containment or building basements. The water is cooled and passed through cleanup equipment which is gradually removing radioactive materials and salt. This recovery work will continue for many months according to the TEPCO recovery plan [2].

2.2 Spent fuel storage

Spent fuel discharged from a Fukushima-type reactor is initially stored in the spent fuel pool associated with that unit. The spent fuel pool is at the top of the secondary containment and is outside the primary containment (see figure 2.2). Spent fuel is cooled in the spent fuel pool for at least 18 months and can then be moved to the common spent fuel storage pool.

The common spent fuel storage pool held 6,375 fuel assemblies at the time of the accident. Although the central fuel storage pool was without active cooling for 13 days, the temperature rose only a few degrees and did not give rise to any safety concerns. Normal cooling was then resumed.

After at least five years in the central fuel storage pool, the assemblies can be transferred to dry storage. At the site, 408 assemblies were in dry cask storage and were unaffected by the earthquake and tsunami.

Table 2.2 shows the inventory of fuel assemblies in the spent fuel pools in units 1 to 4.

Table 2.2 Spent Fuel Pool Inventories (fuel assemblies)

Unit	Fuel in reactor	Spent fuel in pool	New fuel in pool
#1	400	292	100
#2	548	587	28
#3	548	514	52
#4	0	1,331	204

Fuel in the individual reactor spent fuel pools was a concern after the accident as active cooling was lost. However, in the absence of leakage, there was sufficient water to maintain fuel cooling for a few days. The heat load in unit 4 was high because the entire core had been unloaded into it recently. After the explosion in unit 4 on March 15, Japanese authorities were concerned that the pool could be leaking, leading to the fuel uncovering, overheating and generating hydrogen. However, they now believe that the explosion was caused by hydrogen leaking through the containment vent lines from unit 3. The presence of fission products in the unit 4 spent fuel pool indicates that some fuel failures may have occurred but the majority of fuel assemblies are undamaged.

In May, the Japanese authorities became concerned that the earthquake, repeated aftershocks and the explosion in unit 4 may have weakened the concrete structure of the building supporting the spent fuel pool. To address this concern, a steel and concrete support structure was built below the unit 4 spent fuel pool.

2.3 Offsite consequences

Significant releases of radioactive material to the atmosphere began when the reactor containments were vented, beginning at about 20 hours after the earthquake for unit 1 and over 40 hours after the

earthquake for units 2 and 3. Major releases began on March 15 (4 days after the earthquake). An evacuation zone of 20 km had already been established. Figure 2.3 shows radiation readings taken at various locations within Fukushima Prefecture. For comparison, the United Nations Scientific Committee on the Effects of Atomic Radiation (UNSCEAR) [3] states that natural background radiation around the world typically ranges between 1 and 13 mSv/year (0.1 to 1.5 μ Sv/hr.), with an average of 2.4 mSv/year (about 0.3 μ Sv/hr.). The figure shows that the radiation levels are falling back towards normal background levels, although they are still higher than before the accident.

Figure 2.3 Radiation Readings in Fukushima Prefecture

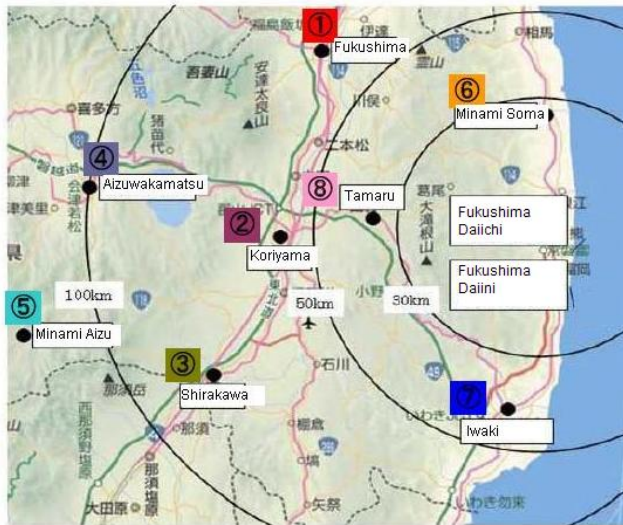
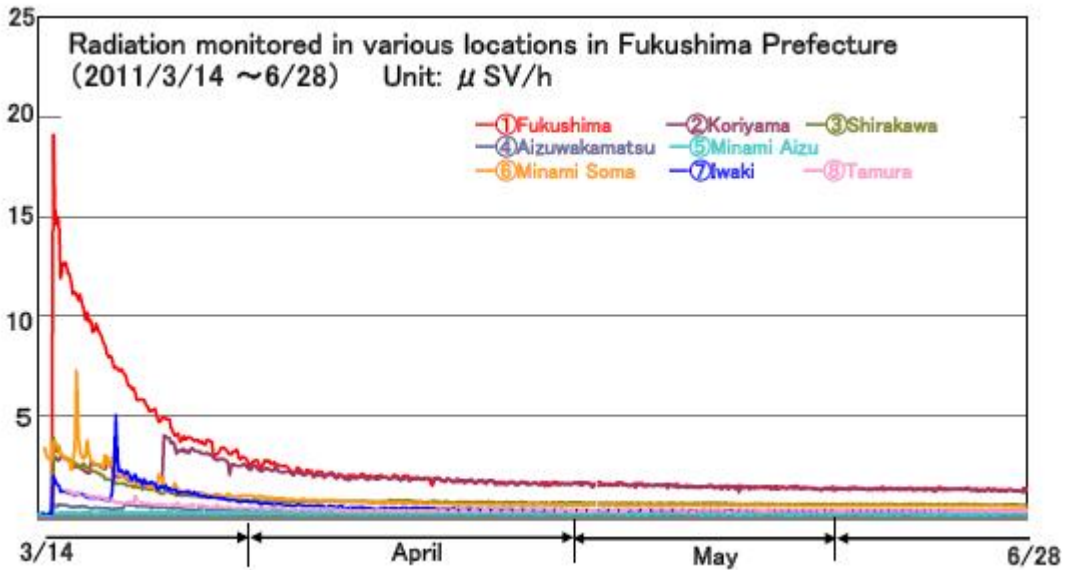

The Japanese authorities expanded the protective measures around Fukushima Daiichi as the accident progressed and the releases of radioactive materials increased. In the first few days and weeks after an accident, the most significant risk is from radioactive iodine-131 (half-life of 8 days). On March 11 (day 1), at 9:23 p.m. local time (6.6 hours after the earthquake), the authorities established an evacuation area with a radius of 3 km and a sheltering area with a radius of 10 km. The following

day, they extended the evacuation zone to 20 km and on March 15 (day 5) to 30 km. Preparations for distributing stable iodine⁹ tablets began on March 12 (day 2).

Figure 2.4 shows the estimated external doses that would be received in the first year in the absence of evacuation.

Figure 2.4 Estimated First-year Doses

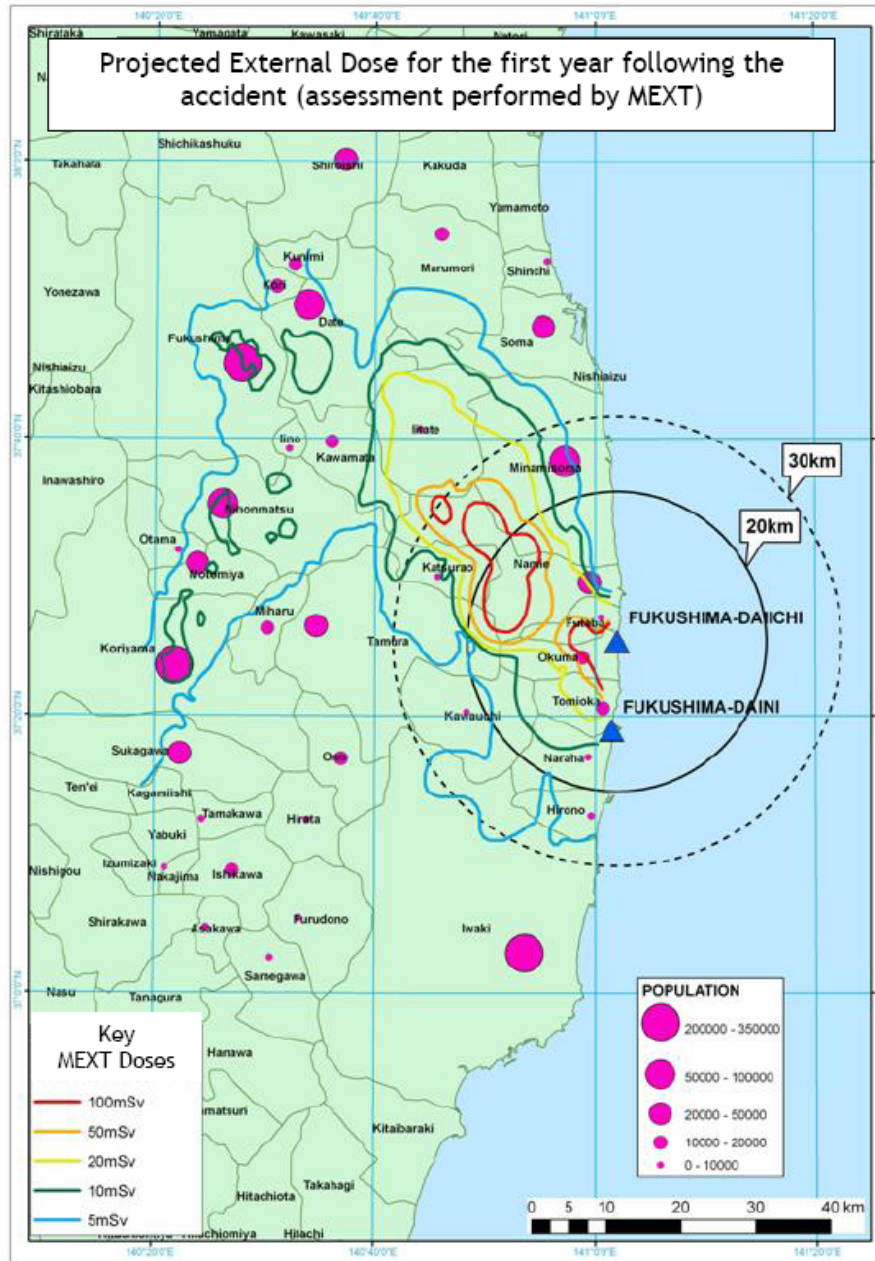

⁹ Stable iodine in the form of potassium iodide (KI) is used to saturate the body with non-radioactive iodine so that radioactive isotopes of iodine are not taken up by the body. Iodine-131 is a particular hazard in the early days of an accident. Iodine concentrates in the thyroid gland and iodine-131 exposure can lead to increased risk of thyroid cancer later in life.

Figure 2.4 was developed by the French Institut de Radioprotection et de Sûreté Nucléaire (IRSN) [4] using data published by the Japanese Ministry of Education, Culture, Sports, Science and Technology (MEXT) and shows only external doses. Additional doses due to internal exposures, such as through inhaling contaminated air, ingesting contaminated foodstuffs and drinking water, would be in excess of this. The long-term external dose is dominated by the isotopes cesium-137 (half-life of 30 years) and cesium-134 (half-life of 2 years) which were deposited following releases from the damaged reactors.

Health Canada's *Canadian Guidelines for Intervention During a Nuclear Emergency* [5] recommend evacuation of the population if the projected whole-body dose¹⁰ exceeds 50 mSv in 7 days. The International Commission on Radiological Protection (ICRP) publications 103 [6] and 109 [7] recommend protective measures (such as evacuation) if the projected dose is between 20 and 100 mSv/year, with the responsible authority establishing the desired level of protection. Although for radiation protection purposes we assume that all radiation exposures present a health risk, in practice, no adverse health effects have been observed at doses below about 100 mSv.

On April 22, an irregular evacuation zone was established to move people from the northwest area where higher activity had been measured. Some areas may remain uninhabitable for many years.

With the evacuation zones in place, it seems unlikely that members of the public will be exposed to external doses greater than 20 mSv/year. Monitoring and control of food and water supplies have been established over a wide area. These controls will need to be maintained, perhaps for many years.

3 Initial CNSC Response

Immediately after the incident, the CNSC took the following actions:

- activated the CNSC Emergency Operations Centre (EOC) and staffed it 24/7 to monitor the emergency, assess early reports and provide timely, accurate information to Canadians
- requested Canadian licensees of Class I nuclear facilities, uranium mines and mills to review the lessons learned
- performed inspections and walkdowns at nuclear facilities to assess system readiness of mitigating systems
- convened a Task Force to evaluate the operational, technical and regulatory implications of the accident for NPPs

These actions are discussed in the subsections below.

3.1 Activation of the CNSC Emergency Operations Centre

Following notification of the Fukushima Daiichi accident, by midday, March 11, the CNSC EOC was activated at its headquarters, in accordance with the *CNSC Emergency Response Plan CAN – 2.1* [8]. Staff from the CNSC Nuclear Emergency Organization (NEO) assembled in the EOC to assess the situation in Japan and develop the strategy for the Canadian response. For 23 days, CNSC NEO staff worked in the EOC on a 24/7 basis to monitor and assess the situation in Japan. CNSC specialists provided expertise in the fields of reactor technology, accident progression and radiation protection.

¹⁰ Projected dose is the dose that would be received in the absence of protective measures.

The CNSC NEO monitored the situation in Japan in close collaboration with other Government of Canada departments and agencies, nuclear regulators from the United States, United Kingdom and France, as well as with the International Atomic Energy Agency (IAEA). The CNSC NEO supported the Department of Foreign Affairs and International Trade Japan Crisis Team on a daily basis by providing timely and accurate information and advice to Canadians in Japan and in particular to the Canadian ambassador and his staff in Japan. Information was posted on the CNSC Web site to provide a consistent, objective and credible source of information for the Canadian public, CNSC staff and other government departments.

Following the deactivation of the EOC on April 4, 2011, CNSC staff undertook a formal lessons-learned process to capture the important operational experience. An after-action report and an improvement plan were approved by the CNSC Management Committee. These reports are summarized in Appendix C.

3.2 Regulatory request to licensees

Subsection 12(2) of the *General Nuclear Safety and Control Regulations* [9] places an obligation on licensees to respond to a request from the Commission, or a person who is authorized by the Commission, to “conduct a test, analysis, inventory or inspection in respect of the licensed activity or to review or to modify a design, to modify equipment, to modify procedures, or to install a new system or new equipment”. In accordance with this provision, the CNSC Executive Vice-President and Chief Regulatory Operations Officer wrote to all Class I nuclear facilities on March 17 requesting that licensees:

- “review initial lessons learned from the earthquake in Japan and re-examine the safety cases of nuclear power plants, in particular the underlying defence-in-depth concept, with focus on:
 - external hazards such as seismic, flooding, fire and extreme weather events;
 - measures for the prevention and mitigation of severe accidents;
 - emergency preparedness; and
- report on implementation plans for short-term and long-term measures to address any significant gaps.”

Letters similar to the “12(2) letters” described above were sent to the operators of uranium mines and mills licensed by the CNSC. The Fukushima accident has the greatest relevance to NPPs and the CNSC has addressed it first through the work of the CNSC Task Force reported here. CNSC staff will use the results of the Task Force investigations of NPPs to drive continuous improvement at other facilities.

3.3 CNSC inspections of Canadian nuclear power plants

Immediately after the Fukushima event, CNSC site staff performed walkdowns at Canadian NPPs to verify the licensees’ emergency preparedness for external hazards and severe accidents so that the CNSC could reassure the Commission and Canadian public that certain aspects that had contributed to the events in Japan had been specifically verified. These aspects included:

- seismic:
 - readiness of secondary control room and seismic route
 - availability of manuals and procedures

- fire:
 - confirmation of minimum shift complement¹¹ monitoring
 - arrangements for offsite support
- backup power availability and condition
- hydrogen igniters:
 - routine testing to confirm availability
- irradiated fuel bays (IFBs):
 - readiness of components and equipment
 - provision/availability of make-up water and heat sinks¹²
 - verification of alarms on flow, temperature, and stack release

This information was reported to the Commission on March 30, 2011, in CMD 11-M15, *CNSC Staff Presentation on Fukushima Event* [10]. There were no significant findings and no actions were placed on the licensees as a result of these inspections.

CNSC staff also verified the following activities taken by the licensees:

- capability of installed equipment and associated procedures to mitigate conditions that result from beyond-design-basis accidents
- capability of provisions to mitigate station blackout¹³ conditions, including robustness of backup power and the emergency power supply systems
- capability to mitigate consequences of external events that may lead to beyond-design-basis accidents
- identification of important equipment needed to mitigate consequences of external events
- identification of any potential scenarios that could compromise the equipment's function during seismic events
- ability of units to rapidly reduce reactor power to match the station power demand following a loss of offsite power, the duration of battery backup, and fuel supply to emergency generators

As reported to the Commission on June 8, 2011, in CMD 11-M30, *Status Report on Power Reactors* [11], CNSC staff are satisfied with short-term actions taken by licensees.

3.4 The CNSC Task Force

The CNSC Fukushima Task Force [12] was set up to evaluate operational, technical and regulatory implications of the 2011 Fukushima Daiichi accident on Canadian NPPs. It was also tasked with reviewing NPP licensees' responses to the 12(2) letters. The Task Force Chair was tasked with reporting the results of the Task Force review to the Executive Vice-President and Chief Regulatory Operations Officer of the CNSC.

¹¹ The minimum shift complement is the minimum number of qualified staff required to be present to ensure that the licensed activity can be carried out safely.

¹² A heat sink is a place to reject excess heat. It includes the equipment and fluids needed to transport the heat from the source (e.g., nuclear fuel) to the sink (e.g., the atmosphere or a large body of water).

¹³ Station blackout formally refers to the loss of normal and backup AC power but not loss of emergency power. In this report, loss of emergency power is also considered. Normal AC power is supplied from the electrical grid and from the station's own main turbine generators. Backup power is supplied by multiple standby generators. Emergency power is supplied by independent generators.

The mandate of the CNSC Task Force was to:

- review submissions from licensees who had been directed under 12(2) letters to re-examine the safety cases of their respective NPPs; underlying defence in depth against external hazards; severe accidents; and emergency preparedness
- assess available technical and operational information from the events at the Fukushima Daiichi NPP and identify a high-level set of lessons learned
- develop recommendations for short-term and long-term measures to address any shortcomings at CANDU reactors, and recommend whether design or operational modifications, including supporting research, are needed
- determine priorities for implementation of corrective actions from lessons learned and the need for further examination
- develop recommendations, as appropriate, for potential changes to CNSC regulatory requirements, inspection programs and policies for existing CANDU reactors and new builds

The CNSC Task Force prepared the *Nuclear Power Plant Safety Review Criteria* [13] to define measurable criteria for each area of the assessment.

The CNSC Task Force met with licensees on a number of occasions to clarify CNSC expectations.

4 International Response

The worldwide response of nuclear organizations, operators and regulators has been to attempt to learn all the salient lessons from the events at Fukushima. The CNSC Task Force has communicated regularly with other regulatory bodies and followed the work of the international community to date. CNSC staff will continue to review the findings of other organizations as they become available.

4.1 Review of terms of reference of international task forces

Members of the CNSC Task Force have monitored the approaches of selected international task forces. The terms of reference of selected task forces have been reviewed to help validate the CNSC's approach. The selected international task forces were from the United States Nuclear Regulatory Commission (U.S. NRC) [14] and the Western European Nuclear Regulators' Association (WENRA) [15].

The CNSC Task Force found that the three task forces have broadly similar terms of reference. The WENRA approach has provided the basis for many of the reviews currently being performed around the world.

WENRA has developed an approach based on design and safety analysis techniques. The approach places particularly strong emphasis on giving a detailed and systematic evaluation of accident progression that considers successive failures of the mitigating measures and identifies key timings and potential cliff edges¹⁴.

¹⁴ A cliff edge is a large increase in the severity of an event caused by a small change of conditions. Cliff edges can be caused by changes in the magnitude of the event or changes in the plant response. For example, a small change in wave height leads to a large change in conditions if the wave goes over the shore defences (e.g., a seawall).

WENRA explicitly mentions consideration of accidents at multiple reactors on a site but gives little emphasis to this aspect. The CNSC Task Force placed more emphasis on multi-unit events since the multi-unit reactors in Canada share parts of containment.

The U.S. NRC review was focused on the adequacy of its own specific regulatory requirements and did not include (at this stage) input from licensees.

After the above comparison was completed, the European Nuclear Safety Regulators Group (ENSREG) released its “stress test” specification [16]. The specification was based closely on the WENRA stress test and does not change the CNSC Task Force review findings.

The CNSC Task Force found that the CNSC terms of reference and *Nuclear Power Plant Safety Review Criteria* are consistent in general terms with the approaches seen in the other international task forces and include the specific areas of emphasis identified above.

4.2 Early results of other international task forces

Most nuclear regulators and organizations have prepared, or are preparing, lessons-learned reports. Selected reports that were available in time to be considered here have been reviewed and their findings evaluated to help ensure that the CNSC Task Force assessment is comprehensive. Note that many other reports will become available later. CNSC staff will review them, but not in the context of the present report.

One of the earliest and most comprehensive reports is Japan’s report to the IAEA Ministerial Conference on Nuclear Safety [1]. The CNSC Task Force has used this report extensively to help it understand the accident and Japan’s response to it. Lessons identified by other members of the international community are also considered in the discussion below.

The most important lessons learned and their importance from a Canadian perspective are discussed below. Cross-references are provided to the section of this report where each lesson is addressed.

4.2.1 Identification and magnitude of external hazards

The Japanese government considers that the fundamental cause of the accident at Fukushima Daiichi was a failure to identify the appropriate magnitude of the tsunami hazard.

All external events (not just seismic and tsunami) relevant to Canadian NPPs must be identified and the selection of appropriate magnitude for the events must be verified. External events are assessed in section 6.1.

4.2.2 Diverse power supplies

Fukushima Daiichi units 1 to 4 lost connections to the grid, and the emergency diesel generators were flooded. The units still had air-cooled emergency diesel generators that were probably functional but could not use them as the switchgear had been flooded. It is not enough to have available power supplies; the full train of heat removal equipment from the reactor or spent fuel pool to the ultimate heat sink must be operable.

Existing Canadian NPPs and most of the proposed designs for new reactors rely on active safety systems to sustain core cooling in the long term. These require electrical power to function.

The consequences of the loss of power supplies and the timescales available for their restoration are assessed in section 6.3.

4.2.3 Diverse means of cooling fuel

Fukushima Daiichi unit 1 was able to maintain core cooling for only about 1.6 hours after the loss of all electrical power. Units 2 and 3 had steam-driven coolant make-up capability (with no electrically driven pumps) and maintained core cooling for 70 and 36 hours respectively, but were still not able to prevent core damage.

Existing Canadian NPPs and most of the proposed designs for new NPPs rely on active¹⁵ cooling for reactors, containment and irradiated fuel bays (spent fuel pools). All designs have some degree of passive cooling capability. The effective duration for the various passive heat sinks varies with the design.

Loss of cooling of the irradiated fuel bays is generally a lesser concern than loss of core cooling as much more time is available before fuel overheats. However, irradiated fuel bays generally have fewer alternative cooling options than the core; therefore the issue is still important.

The cooling function, the consequences of its loss and the timescales available for restoration are assessed in section 6.3.

4.2.4 Prevention of hydrogen explosions

Adequate mitigation is needed wherever hydrogen can accumulate, in order to prevent explosions. The Fukushima Daiichi design anticipated hydrogen production in severe accidents by filling the primary containment with nitrogen so that there was no oxygen available for hydrogen combustion. However, hydrogen produced by the damaged cores either leaked from the primary containment or from the containment vent system ducts and accumulated in the secondary containment. There were no provisions for hydrogen mitigation in the secondary containment. In the secondary containment, the hydrogen mixed with air to produce an explosive mixture which subsequently ignited, adding to the damage.

CANDU reactors have some installed capability to compensate for their large inventory of zirconium compared to other reactor designs. Provisions for mitigation of hydrogen are assessed in section 6.3 and 6.4.

4.2.5 Containment venting

The Fukushima Daiichi reactors had a venting system to protect the containment from overpressure. The loss of electrical power caused difficulties in operation, and some periods of overpressure were reported. However, the system appears to have been successful in preventing gross containment failure due to overpressure. Leakage from the venting system (perhaps caused by the earthquake) likely contributed to the hydrogen leakage that led to explosions in the secondary containment.

Controlled containment venting can protect containment from overpressurization during beyond-design-basis accidents. Filtering of fission products to the extent practicable is important in reducing radiation exposure to the public.

¹⁵ Active cooling relies on equipment with external input, such as electricity. Passive cooling relies on natural forces, such as gravity.

Multi-unit CANDU reactors have a “negative pressure design” achieved by the provision of a large vacuum building supported in the long term by a filtered venting system. This type of design can be effective in limiting the release of radioactive material in design-basis accidents as any leakage is into the containment. However, these systems are not designed to handle the large gas volumes that a severe accident may generate. Moreover, electrical power is required for controlled venting of the containment to maintain a negative pressure.

Provisions for containment venting and their operability are assessed in sections 6.3 and 6.4.

4.2.6 Protection of essential equipment

At the Fukushima Daiichi plant, safety-related equipment – particularly electrical supplies – was lost in the tsunami.

Essential services can be protected from external hazards and internal events by the separation of redundant equipment (including vertical separation), by physical protection (e.g., fire barriers or waterproof rooms) or by hardening¹⁶ (e.g., environmental qualification).

Mitigation of beyond-design-basis accidents and severe accident management are assessed in sections 6.3 and 6.4.

4.2.7 Challenges to multi-unit nuclear power plants

The Fukushima accident emphasized that multi-unit NPPs face unique challenges, and that common-cause failures should be particularly considered for multi-unit sites.

Events involving multi-unit CANDU reactors can be complex and challenging. Containment integrity for multi-unit severe accidents should be assured by adequate venting. The risks and implications of hydrogen explosions should be particularly considered for multi-unit sites and necessary mitigating systems should be properly located and implemented.

Other important considerations for multi-unit NPPs are:

- availability of staff and resources to address a severe accident impacting several units simultaneously, and overall effectiveness of severe accident management guidelines (SAMG)
- shared equipment
- calculation and control of potential source terms¹⁷
- impact on nuclear emergency plans

Challenges arising from multi-unit NPPs are assessed in sections 6.3 to 6.5.

¹⁶ Equipment can be “hardened” to withstand harsh conditions by using suitable materials and conservative design.

¹⁷ The source term is the amount and isotopic composition of material released (or postulated to be released) from a facility.

4.2.8 Effective severe accident management

Accident management measures were available at the Fukushima Daiichi plant, but were only partially successful due to many factors, mostly related to the extent of the damage.

Challenges in executing severe accident management actions are likely to occur after any major external event due to consequential damage onsite and/or loss of critical infrastructure offsite. Specific challenges will depend on the nature of the event.

There may be additional challenges specific to multi-unit sites where one or more units are damaged. This situation can lead to difficulties of access and additional strains on staff.

Effective accident management requires availability of equipment, either pre-installed, available onsite or available offsite, as appropriate. The equipment should be maintained and tested sufficiently to give reasonable confidence that it will function when required. Accident management guidelines must be prepared and staff trained in their use. There must be sufficient staff to execute the guidelines. Verification of the guidelines should consider the likely environment in which the operators must work (e.g., radiation fields, damaged plant systems) and provide options where practicable (e.g., alternative water injection points or electrical connections). Survivability of essential instrumentation should be assessed to provide reasonable assurance that the essential instrumentation will be available to guide operator actions.

Severe accident management is assessed in section 6.4.

4.2.9 Emergency response

The earthquake, tsunami and subsequent nuclear accident placed enormous strains on the emergency response capability of Japan, the Fukushima prefecture and the NPP operator.

Major earthquakes and tsunamis are not credible threats at Canadian NPPs. Nevertheless, some hazards can lead to widespread disruption (e.g., ice storm or heavy snowfall). Others can be very damaging in a local area (e.g., explosion, tornado). Emergency measures must be capable of reacting to all credible events.

Effective emergency response relies on defined roles and responsibilities and clear lines of communication. Timely information must be available to those who need it, both in terms of the accident consequences and clear guidelines for protective actions. Communication must be considered for all stakeholders: local, national and international.

Emergency response is assessed in section 6.5 (for licensees' responsibilities) and section 7 (for federal, provincial and municipal responsibilities).

4.2.10 Legal and regulatory infrastructure

The Japanese government considered that the Fukushima accident revealed weaknesses in the legal and regulatory infrastructure and regulatory framework in Japan. This, the Japanese government holds, led to the establishment of a new regulatory body independent of the Ministry of the Economy, Trade and Industry. In some areas, regulatory requirements did not exist or were not mandatory. Some parts of the safety case for the NPPs were identified as having received scant attention.

Canada's regulatory framework and processes are assessed in section 8.

5 Comparison of Canadian and Japanese External Hazards

Canada's risks from external hazards are different from Japan's. The tsunami generated from the magnitude 9.0 earthquake was the direct cause of the severe accident at Fukushima. The sections below were produced in collaboration with staff of the Geological Survey of Canada and discuss the seismic and tsunami hazards for Canada. Other specific hazards taken into account in the NPP designs are discussed in section 6.1 of this report.

5.1 Canadian tsunami hazard profile

A large underwater earthquake may displace the ocean floor, producing a tsunami that propagates outward from the source, as shown in figure 5.1. Destructive earthquake-induced tsunamis are rare in Canada. In Canada, the Pacific Coast (west coast) is at greatest risk from tsunamis because of the high incidence of earthquakes in that region.

Figure 5.1 Generation of a Tsunami

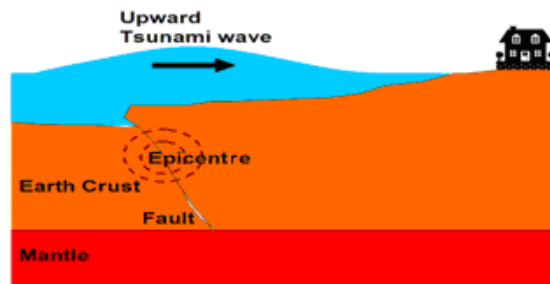

Most often, tsunamis, including the recent ones in Japan, are generated by subduction¹⁸ earthquakes. The Pacific Coast is exposed to the hazard from both local and distant subduction zones. The distribution of earthquakes greater than magnitude 5.0 in Canada is shown in figure 5.2. Note that the figure shows the 18th century Cascadia earthquake along the Pacific Coast, which was estimated to be about magnitude 9.0. Other data is more recent.

¹⁸ Subduction is the movement of one of the tectonic plates making up the earth's crust under another. Subduction zones are associated with high seismic and volcanic activity.

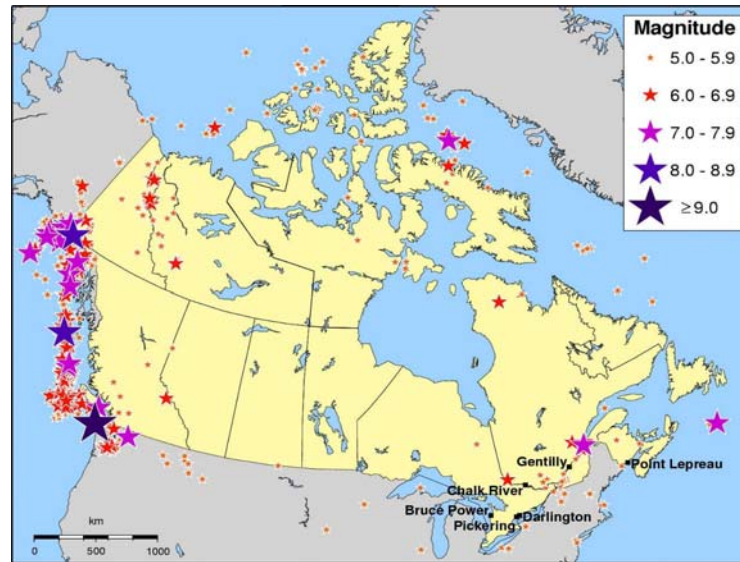
Figure 5.2 Earthquakes Greater Than Magnitude 5.0

The risk of tsunamis at each of the Canadian NPPs is discussed below.

5.1.1 Bruce, Darlington and Pickering

Bruce, Darlington and Pickering are located in the Great Lakes region of Canada. The tsunami risk along the Great Lakes is very low. The Great Lakes are on the edge of the Canadian Shield, a geologically stable, mid-continental region where the rate of occurrence of earthquakes large enough to generate tsunamis is negligible.

5.1.2 Gentilly-2

The Gentilly-2 facility is located in the St. Lawrence River Valley. There is no evidence of a historical tsunami in this region. An earthquake-generated tsunami event has been considered (and modelled) by scientists (for different purposes) for the St. Lawrence estuary [17]. A magnitude 7.0 earthquake could cause a land shift and surface that would generate a very local tsunami with a height of roughly 2 to 4 metres. However, Gentilly-2 is at some distance from historically large, damaging events (more than 100 km from the active regions of western Quebec and Charlevoix). The Charlevoix seismic zone is the most likely source to generate magnitude 7.0 earthquakes that have the potential to create small tsunamis in the St. Lawrence, and the possibility that a tsunami from there would reach Gentilly-2 is very low.

5.1.3 Point Lepreau

Point Lepreau is located in Atlantic Canada on the Bay of Fundy. There are several sources of potential tsunamis for this site. First, trans-Atlantic tsunamis are a possibility. The 1755 great Lisbon earthquake generated destructive waves, but these waves were not large by the time they reached North America's eastern seaboard. There is also the possibility of local earthquakes in the Bay of Fundy and Passamaquoddy Bay generating tsunamis. There is, however, no known evidence of such an event; the probability of a large earthquake in this region generating a local tsunami is considered very low. In addition, the province of Nova Scotia provides some protection from an Atlantic tsunami hitting Point Lepreau because its geographic location acts as a partial buffer.

5.2 Canadian seismic hazard map

The following simplified seismic hazard map for Canada illustrates qualitative seismic hazards everywhere in Canada. The hazard for each NPP is discussed below.

Figure 5.3 Canadian Seismic Hazard Map

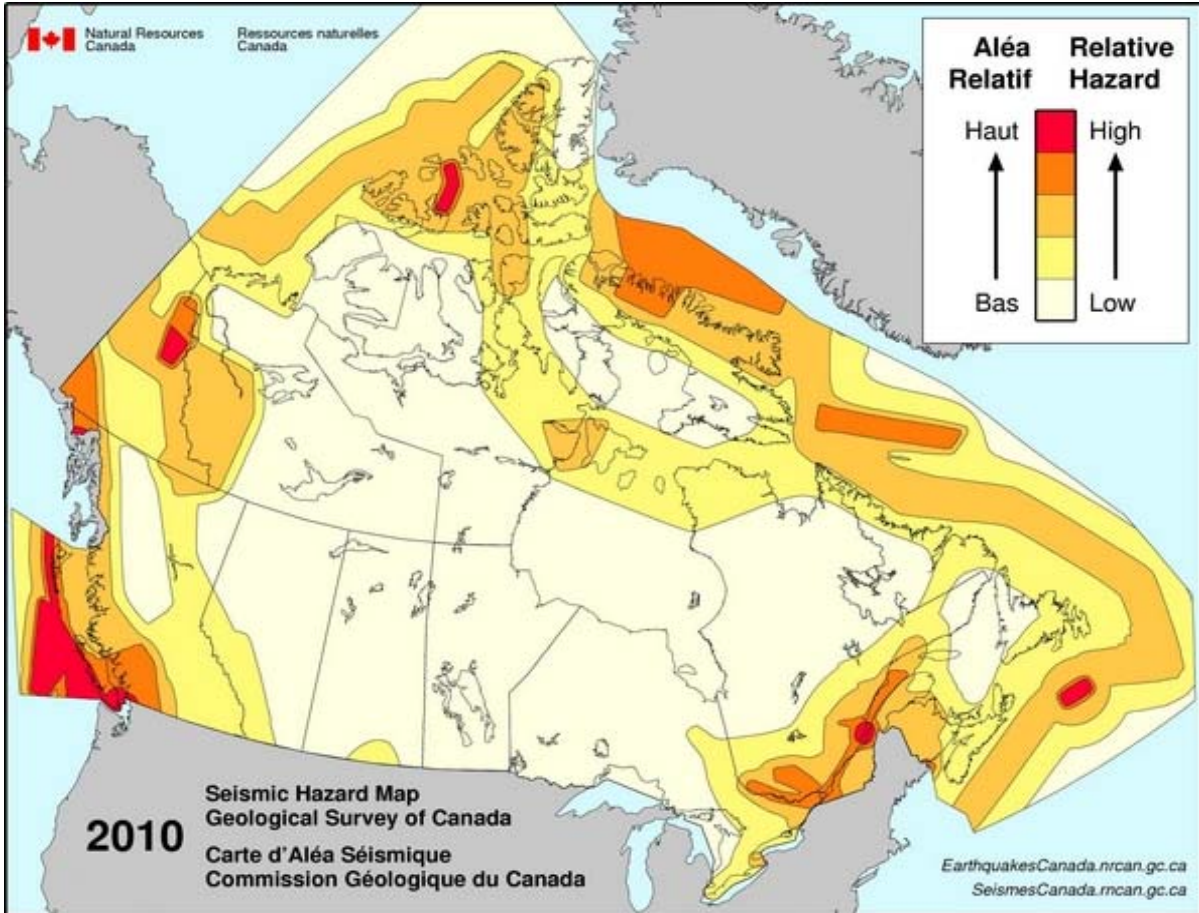

5.2.1 Pickering

Pickering is in a region of low to moderate seismic hazard.

The Pickering facility is located in the southern Great Lakes seismic region. Over the past 25 years, on average, five to six magnitude 2.5 or larger earthquakes have been recorded in the region each year. Three moderate-sized (magnitude 5.0) events have occurred in the region in the last 250 years, all of them in the adjacent northern United States. All three of these earthquakes were widely felt in southern Ontario but caused no major structural damage in Ontario.

In the Pickering region, a possible active fault was investigated by drilling and found to be the result of glacial action. The feature poses no additional seismic threat.

5.2.2 Darlington

Darlington is in a region of low to moderate seismic hazard. Details are the same as for Pickering.

5.2.3 Bruce

Bruce is in a region of low seismic hazard.

Over the past 25 years, only 3 magnitude 2.5 or larger earthquakes have occurred within 100 km of the plant. Moderate-sized (magnitude 5.0 to 6.0) earthquakes have occurred at greater distances (more than 300 km) in the northern United States and western Quebec. None of these events generated significant shaking at the Bruce site.

5.2.4 Gently-2

The Gently-2 facility in Bécancour, Quebec, is in a region of moderate seismic hazard.

The facility is in the St. Lawrence Valley, within a region of moderate seismic activity. Historical records for earthquakes in eastern Canada show that most earthquakes have occurred east of Québec City and near Montreal, and that less activity has occurred between these two places. Past work by the Geological Survey of Canada shows that despite this historical record, a possibility of a significant earthquake in the vicinity of Gently-2 still exists because:

- the fault systems along the St. Lawrence River are the same throughout
- small earthquakes appear to concentrate on these faults

Evaluation studies of the geology of the site have shown that no tectonic fault lies under the site.

5.2.5 Point Lepreau

Point Lepreau is in a region of low to moderate seismic hazard.

The Point Lepreau facility is located in the Northern Appalachians Seismic Zone, which includes most of New Brunswick and extends into New England down to Boston. A series of significant earthquakes occurred in 1982 (largest magnitude 5.6, in the Miramichi Highlands, 200 km north of the facility) and was followed by numerous aftershocks. The zone also witnesses a continuing low level of seismic activity, including many larger historic earthquakes in New Brunswick. The closest source of seismic activity is located in Passamaquoddy Bay, 50 km west of Point Lepreau. A series of moderate earthquakes occurred here in the 19th and early 20th century. The largest recorded event had a magnitude of 5.7 in 1904.

5.3 Other external hazards

Canadian NPPs are considered capable of withstanding a large number of external hazards specific to each site. These hazards include flooding, extreme winds, extreme weather including snow and ice storms, and transportation hazards, among others. These types of hazards and NPP assessments are discussed in section 6.1 of the report.

6 Safety Review of Canadian Nuclear Power Plants

The CNSC licenses each Canadian NPP on the basis of comprehensive safety reports and supplementary analyses which demonstrate that the facility design meets regulatory requirements and expectations. The licensing process also ensures that appropriate safety management systems, plans and programs for safe and secure operation are established. Any new analyses, such as those supporting modifications or new research findings, are incorporated into the safety reports and

supporting analyses. To ensure this, the NPP licences require the licensees to update safety reports every three years and submit them for regulatory review. In addition, the CNSC requires each licensee to conduct an integrated safety review (ISR), including a comparison against modern standards), to establish the scope of refurbishment activities.

The safety reports include the evaluation of the underlying defence-in-depth concept for the effective implementation of safety functions in the facility design. There are five levels to the defence-in-depth approach:

- prevention of abnormal operation and failures
- control of abnormal operation and detection of failures
- control of accidents within the design basis
- control of severe plant conditions, including prevention of accident progression and mitigation of the consequences of severe accidents
- mitigation of radiological consequences of significant releases of radioactive materials

The defence-in-depth concept is supported by emphasis on the inherent safety characteristics of the reactor, and on insights from deterministic and probabilistic safety analyses to evaluate and optimize the overall plant design. In principle, application of the defence-in-depth concept assures the prevention and control of incidents and accidents at several engineering and procedural levels in order to ensure the effectiveness of the protection of physical barriers against the release of radioactive material.

In response to the Fukushima Daiichi accident, the Canadian nuclear industry and regulator sought to ensure that the safety basis discussed above remained valid in the light of lessons learned. As reported in section 3.1, CNSC staff sent a written request on March 17 to licensees, under paragraph 12(2) of the *General Nuclear Safety and Control Regulations*, to review initial lessons learned from the earthquake in Japan.

This section of the CNSC Task Force Report provides an assessment of the NPP licensees' responses to the 12(2) letters. The responses are evaluated against the applicable *Nuclear Power Plant Safety Review Criteria* [13] issued by the CNSC Task Force in June 2011. These criteria generally exceed requirements and expectations of the current CNSC regulatory framework. The CNSC Task Force review findings in this section relate exclusively to the lessons learned from the Fukushima accident. Each subsection below provides specific review findings. In section 10 of this report, these review findings are integrated to provide a concise overview of the areas of potential improvement identified by the CNSC Task Force.

6.1 External hazards

The safety review ensures that external hazards are accounted for in the reactor safety cases. The events considered are specific to each site and include seismic, fire, flood, extreme weather events and events caused by human activities (such as an explosion). The CNSC Task Force assessed the magnitudes that had been considered in the design-basis and beyond-design-basis analyses of external hazards. In many cases, the rationale for the magnitude selected for beyond-design-basis hazards was not documented by the licensees. This is further discussed below.

Consequential events must be considered and include external events (such as a cooling water intake blockage caused by severe weather) and internal events (such as a fire or small-break loss-of-coolant accident¹⁹ caused by an earthquake).

6.1.1 Original design basis

All Canadian NPPs use CANDU reactors. The current CANDU fleet was designed and constructed from the 1960s to 1980s. The designs were based on standards available at that time. For the earlier NPPs (Pickering A and Bruce A), the full scope of design-basis external events was not considered. The design bases were embedded in design guides and engineering judgment.

For some plants that were designed in the later part of this period (Pickering B, Darlington, Bruce B, Gentilly-2, and Point Lepreau) design-basis external events were considered. Such events have included design-basis earthquakes (usually based on a recurrence frequency of 1,000 years), floods (design-basis rainfall or water levels, usually based on a recurrence frequency of 100 years or the highest historical numbers) and high winds. The scopes, however, have been limited. The magnitudes of the external events taken into account for the design are in compliance with the standards applicable at the time of original licensing but below modern international best practice. The integrated safety review performed before an NPP is refurbished ensures that the NPP is assessed against modern standards. Upgrades are performed where reasonably practicable. Nevertheless, the CNSC Task Force finds that licensees should identify the gap between the original design basis and associated magnitudes for external hazards and modern best practices and demonstrate how the gap is being addressed.

As discussed in section 5, the CANDU fleet is located well within the North America tectonic plate and no NPPs are located near a subduction tectonic plate boundary as is the case in Japan. The closest tectonic plate boundary is the Mid-Atlantic Ridge. Canadian NPPs are located in areas of much lower seismic hazard risk than Fukushima.

All Canadian NPPs except Point Lepreau are located beside lakes and rivers and are not subject to the hazard of a tsunami. Based on a scientific assessment of the tsunami hazard, NB Power concluded that the maximum credible tsunami is smaller than the storm surge created by a hurricane. This storm surge, combined with a high tide and waves generated by the high winds, does not reach the plant. CNSC staff accept this assessment.

As a prerequisite to refurbishment, ISRs have been completed for Point Lepreau, Gentilly-2 and Bruce A, with similar reviews performed for Pickering. Some of the NPPs were reassessed for external hazards, especially for seismic hazards. Seismic margin assessments (SMAs) (or SMAs based on probabilistic safety assessments) were conducted to assess the safety margin based on earthquakes with a 10,000-year return frequency. Other external hazards, including floods and high winds, were also assessed and some enhancements have been implemented. The NPPs that were reassessed as part of refurbishment activities were reviewed for external hazards, and their design bases are, to the extent practicable, in line with modern standards and practices.

¹⁹ A loss-of-coolant accident (LOCA) takes place when a break in the primary pipework of the reactor allows reactor coolant to escape into containment.

6.1.2 Probabilistic safety assessment

Currently all NPP licensees are required to perform a site-specific Level 2 PSA²⁰ to meet CNSC regulatory standard S-294, *Probabilistic Safety Assessment (PSA) for Nuclear Power Plants* [18]. This standard requires consideration of all internal events and external hazards in the PSA. Licensees are required to perform a fire, flood and seismic PSA with a methodology that is acceptable to the CNSC staff. Licensees also have to perform a site-specific external hazards screening to identify other hazards that may require a PSA or a bounding analysis²¹. So far, all NPP licensees have submitted their methodologies on external hazards screening and bounding analysis. Some analyses have been completed and it is expected that the remaining analyses will be completed by the end of 2013. This time scale is acceptable to the CNSC Task Force and will provide a consistent and up-to-date review of all external hazards for all NPPs.

6.1.3 Review findings for external hazards

While the CNSC Task Force has not identified external hazards severe enough to need immediate actions from industry or the CNSC, some of the findings identified opportunities for improvements in the industry's approach as well as in the CNSC's approach. These review findings are summarized below.

Review findings concerning licensees:

1. The original magnitudes considered for the design-basis and beyond-design-basis assessments of external hazards were developed for the original licensing of the facilities. Although in general a lot of conservatism was included in the original designs, some design bases are not consistent with modern best practices.
2. The assessment for the design-basis and beyond-design-basis tornado hazard was found to be weak at some NPPs.
3. External hazards screening and bounding analysis are in different states of development for each NPP. Consequently, analysis of all external hazards is not complete at all NPPs.

Review findings concerning the CNSC:

4. The requirements and expectations for defining magnitudes to be used for design-basis and beyond-design-basis hazards have not been reviewed since original NPP licensing. The methodologies used to establish the criteria for these hazards are not consistent with modern best practices.

6.2 Design-basis accidents

Design-basis accidents, including those that may occur at onsite irradiated fuel storage, were not a major focus area for the CNSC Task Force. As stated in the *Nuclear Power Plant Safety Review Criteria* [13], they have been extensively studied by the industry and the regulator for many years. Nevertheless, design-basis accidents were reviewed to ensure that plant safety is adequate.

²⁰ Probabilistic safety assessments may be performed at 3 levels. Level 1 PSA calculates core damage frequency. Level 2 calculates large- and small-release frequencies and Level 3 (rarely performed) calculates offsite health effects.

²¹ A bounding analysis uses conservative assumptions and/or modelling to ensure that the results are more severe than would occur in an actual event.

6.2.1 Regulatory requirements

Early Canadian NPPs were originally licensed based on the Atomic Energy Control Board (AECB – predecessor to the CNSC) *Reactor Siting and Design Guide* [19] which defined the single/dual failure approach. Dose limits were set for a single failure – the failure of process equipment. Dose limits were also set for dual failures – failure of process equipment and simultaneous failure of protective equipment, now referred to as safety systems. External events were not analyzed explicitly. Their effects were implicitly assumed to be covered by the failures of process and protective equipment described above. Darlington was originally licensed based on trial use of the AECB consultative document C6 Rev 0, *Requirements for the Safety Analysis of CANDU Nuclear Power Plants* [20]. Dose limits were set for five event classes, with more restrictive limits for more frequent events. Design-basis earthquakes and tornadoes were explicitly considered in that AECB document. Darlington was also designed to withstand a major explosion.

After original licensing, the importance of external hazards was recognized, and assessments of the ability of NPPs to withstand hazards such as earthquakes and fires were performed, for example using seismic margin assessment²² and fire safe shutdown analysis²³ methods.

More recently, the CNSC issued RD-310, *Safety Analysis for Nuclear Power Plants* [21] and RD-337, *Design of New Nuclear Power Plants* [22]. These two regulatory documents are in line with current international practice and set the dose acceptance criteria for anticipated operational occurrences and design-basis accidents. Safety goals are also set for beyond-design-basis accidents. RD-310 and RD-337 use the term “design-basis accident” to mean an accident with a frequency of occurrence between 10^{-2} and 10^{-5} per year (between 1 in 100 and 1 in 100,000 years).

6.2.2 Results of review of design-basis accidents

The CNSC Task Force has confirmed that the safety analysis of each NPP adequately considers design-basis accidents by analyzing credible failures in process and safety systems. These failures can result in challenges to fuel cooling in the reactor core and spent fuel bays. The predicted consequences for these accidents (with conservative safety analysis assumptions) provide bounding estimates for the consequences of the external hazard accident scenarios within the design basis. The safety report of each NPP shows that the predicted consequences for each design-basis accident meets the CNSC’s prescribed acceptance criteria.

From the review of design-basis accidents in light of the Fukushima Daiichi accident, the CNSC Task Force finds that two safety aspects merit further attention:

- External hazards can result in accidents lasting for several days. Current safety analysis tends to show that a stable state is reached after a design-basis accident, but not that it can be maintained long term. Safety analysis should demonstrate that adequate design provisions and operating procedures are in place to ensure the key safety functions of “control, cool and contain” are maintained throughout the accident duration.
- Disruptions to fuel cooling in a shutdown reactor for an extended duration, while the heat transport system is maintained at elevated pressure and temperature conditions, may lead to fuel damage. This has the potential to transition from a design-basis accident to a beyond-design-basis accident, potentially resulting in severe core damage. Safety analysis of such

²² A seismic margin assessment is a formal method for evaluating the capability of structures and equipment to withstand earthquakes. It was developed by the Electric Power Research Institute.

²³ A fire safe shutdown analysis is a formal method for evaluating the capability to safely shut down and cool a reactor core in the event of a fire.

design-basis accidents should demonstrate that adequate provisions are in place to ensure successful transition of the reactor from a hot pressurized shutdown state to a cold depressurized shutdown state.

Current safety reports do not adequately address the above two safety aspects. This deficiency is considered to be a documentation issue; operating procedures and equipment are in place in all CANDU reactors to ensure that the key safety functions are carried out for extended durations, and to bring the reactor to the cold depressurized shutdown state if required following an accident. The CNSC Task Force finds that future safety report updates should ensure that these issues are addressed more thoroughly.

RD-310 provides a modern, comprehensive treatment of external and internal events and accidents. However, RD-310 has not yet been fully implemented at existing NPPs. The CNSC and licensees are working towards full implementation.

Until full implementation of RD-310-based safety analysis, some lack of consistency in the analysis and reporting of design-basis accidents and events will remain. This arises largely from the differences between licensing requirements when the original licence was issued and the changes applied over the years.

6.2.3 Review findings for design-basis accidents

The CNSC Task Force has verified that, despite some lack of consistency, existing safety reports, supplemented by hazards assessments, show that the NPPs meet or exceed the original design intent.

Adequacy of safety analysis is assessed and reported to the Commission during the relicensing process for each NPP.

This review identified the following findings, all of minor concern:

1. Implementation of a safety analysis framework based on RD-310, *Safety Analysis of Nuclear Power Plants*, is incomplete.
2. Safety analyses have demonstrated that equipment and procedures are adequate to ensure that, for all design-basis accidents where core cooling is lost when a shutdown reactor is hot and pressurized, the reactor can be taken to a stable state. However, analysis to show that the NPP can be taken to a cold, depressurized state is incomplete.
3. Safety analyses have not demonstrated that, for all design-basis accidents, equipment and procedures used to take the reactor to a cold, depressurized state can maintain that state for a prolonged period.

6.3 Beyond-design-basis accidents

A major class of beyond-design-basis accidents are those involving a loss of all heat sinks. The most challenging of these are caused by loss of electrical power. The Fukushima Daiichi accident was of this type and is the focus of this section of the CNSC Task Force Report.

Beyond-design-basis accidents are analyzed to:

- identify possible recovery actions
- demonstrate that there is sufficient time to perform recovery actions
- assess the consequences of failure of recovery actions

The information submitted by licensees in response to the CNSC request for information about beyond-design-basis accidents is summarized below. The topics address the beyond-design-basis accident criteria given in section 2.3 of the CNSC Task Force *Nuclear Power Plant Safety Review Criteria* [13].

6.3.1 Progression and timing of beyond-design-basis accidents

As requested by the CNSC, licensees have performed assessments of beyond-design-basis accidents. Licensees have presented a sequence based on a prolonged loss of electrical power, leading to a loss of all heat sinks. For the purposes of the review of the accident sequence, it is not necessary to postulate any particular external event. It is simply assumed that electrical supplies to power primary and secondary heat sinks are not available.

The accident scenario includes assuming progressive failure of all mitigating measures. While the resulting scenario has an extremely low probability, it provides a means of identifying possible mitigating strategies at each stage of the accident and the time available to implement them.

The accident progression is presented in detail in Appendix B. Potential intervention points where the accident progression could be halted or delayed are noted.

All licensees provided an assessment that was adequate for the CNSC Task Force to perform its review. The event progression described by licensees is in agreement with the CNSC's understanding, except for the timing. The CNSC Task Force assessment of the time available before pressure tube failure indicates that it may be approximately 1 hour shorter than that given by industry. There may be less available recovery time than currently expected. The CNSC Task Force finds that the predictions of the timing of pressure tube failure in CANDU reactors should be verified.

The Fukushima Daiichi accident demonstrated the destructive power of hydrogen explosions. All licensees have plans to install (or have installed) passive autocatalytic recombiners²⁴ to improve mitigation of the risk from hydrogen explosions. The CNSC Task Force finds that, where not already done, these plans should be accelerated.

6.3.2 Duration of backup services

As discussed in Appendix A, Canadian NPPs have large inventories of water that can be used as passive heat sinks in the event of a loss of electrical power. The duration of these passive heat sinks is different for each NPP and is discussed in more detail in Appendix B. No fuel damage will occur if AC power is restored within 1 hour (and within a much longer period of time for some NPPs). If simple operator actions to enable gravity feed to the boilers are executed promptly within this 1-hour time frame, this time can be increased significantly, and release of radioactive material would not occur before at least 17 hours after the accident²⁵. Again, operator actions can significantly extend this period to over a day, even in the absence of normal power supplies.

Although the focus of this section of the CNSC Task Force report is on loss of all electrical power, a much more likely outcome for Canadian NPPs would be that either the normal backup (standby generators) or the emergency backup (emergency power supply) would function and no such loss of

²⁴ Passive autocatalytic recombiners (PARs) comprise a catalyst-coated metal surface. The catalyst promotes combination of hydrogen and oxygen in the containment atmosphere to produce water. With a sufficient reaction area, PARs can prevent the hydrogen concentration from rising to combustible or explosive levels.

²⁵ This time is a conservative estimate, and the actual time is likely to be longer.

all electrical power would occur. Staff confirmed that many days' supply of fuel is immediately available to these generators, typically sufficient for three to four days (for each standby generator with no outside supply if operated at full design power).

Following a loss of all electrical power, batteries support essential services until normal or backup power is available. CANDU reactors have the guaranteed capability to support all essential electrical equipment for 40 minutes, although the batteries may last significantly longer. This duration is short compared to other essential supply capabilities. Moreover, once batteries are exhausted, the control and instrumentation functions are lost. Operators must take special measures (such as using self-power instruments) to obtain information on which to base recovery actions. The CNSC Task Force finds that licensees should explore options to extend the duration of power supplies to instrumentation and control equipment that may be needed to mitigate beyond-design-basis accidents, including severe accidents.

6.3.3 Margin to failure of mitigating equipment

The assessment of beyond-design-basis accident progression assumed progressive failure of all mitigating measures, leading inevitably to core meltdown. For this reason this sequence does not provide margin-to-failure information – the information about how close the equipment is to failure. However, the following instances were noted where it may be worthwhile performing additional assessments and/or design changes.

The CNSC Task Force notes that the instrumentation needed to guide accident management actions may not survive the harsh conditions of beyond-design-basis accidents. The CNSC Task Force finds that licensees should assess equipment survivability (not full environmental qualification²⁶) to provide reasonable assurance that adequate information will be available to the operator.

Class I/II batteries are not formally qualified for external hazards (except at Pickering A stations where Class I batteries are seismically qualified). Licensees should determine the minimum design requirements for qualification of Class I/II equipment to mitigate beyond-design-basis accidents involving loss of all AC power and verify that the equipment can survive the accident conditions.

As noted above, CANDU reactors have large inventories of water in the calandria vessel and the shield tank that can provide passive heat sinks in beyond-design-basis accidents. However, the equipment was not designed for this purpose. The following paragraphs describe issues that may prevent these heat sinks from meeting their full potential.

After a loss of all heat sinks, and assuming no recovery action by the operator, secondary water inventory boils away, leading to heatup and boiling of the primary coolant. Steam is vented through relief valves into the degasser (or bleed) condenser²⁷. The degasser condenser pressurizes and its relief valves open to vent steam into containment. Based on analysis of the licensees' submissions, the degasser condenser relief valve capacity may not be adequate in this beyond-design-basis accident. Inadequate relief capacity would lead to earlier failure of pressure tubes and shorter available recovery times than would be the case if relief capacity was adequate. The CNSC Task Force finds that licensees should perform tests to verify the capacity of the degasser (or bleed) condenser relief valves to respond to a complete loss of heat sinks.

²⁶ Environmental qualification is a formal process for ensuring that equipment will function in a harsh environment, for example high temperature, pressure and humidity resulting from an accident.

²⁷ The degasser (or bleed) condenser is a vessel in the pressure and inventory control system. One of its main functions is to act as a buffer volume to accept steam and water discharged from the primary relief valves.

Further in the accident sequence, after the onset of severe core damage, the core debris falls progressively to the bottom of the calandria vessel. Heat is transferred through the calandria vessel wall into the shield tank (or calandria vault on some designs). The steam generated by boiling in the shield tank would cause the tank to pressurize. The shield tank relief valves may not have sufficient capacity in this beyond-design-basis accident. The shield tank would fail due to overpressure and, if the rupture is low in the vessel, most or all of the available water would be lost, leading to an earlier failure of the calandria vessel than would be the case if adequate relief was available. This reduces the time available for mitigating action and for offsite emergency measures. The CNSC Task Force finds that licensees should verify that there is adequate pressure relief for severe accidents.

6.3.4 Re-evaluation of consequential events

Consequential events (such as a tsunami caused by an earthquake) are considered in NPP probabilistic safety assessments. Selected cases are reported in the NPP safety reports. The CNSC reviews these assessments as they are submitted and has not re-evaluated them for this report.

The key difference for events with a consequential loss of primary coolant would be to reduce the time until core overheating. The timings of the remainder of the analyzed cases would not be significantly changed. However, mitigation by make-up²⁸ to the boilers would not be effective in the case of significant primary leakage. Given the low likelihood of significant damage to the primary pressure boundary and the limited additional impact of the consequential failure, the CNSC Task Force considers that no additional work is necessary in this area.

6.3.5 Multi-unit considerations

Analysis performed for multi-unit NPPs (Pickering A and B, Bruce A and B, and Darlington) was based on a computer model that represents only a single unit. The effect of a severe accident simultaneously in four units is approximated by modelling the shared part of the containment as one quarter of its true size.

This approach is accepted to give broadly representative results of the accident source term but would not be capable of calculating, for example, the effects of different times of core meltdown in the different units. In some effects, the current modelling may be conservative. For example, all four units would be very unlikely to experience identical failures, such as vessel failure, at the same moment, thus the corresponding containment pressure increases may be over-predicted. Other effects may not be captured, such as higher than average local hydrogen concentrations.

The CNSC Task Force finds that licensees should develop the capability to model severe accidents in multi-unit NPPs. The current models are adequate for single-unit NPPs.

6.3.6 Irradiated fuel bay

The irradiated fuel bays (IFBs) (spent fuel pools) at most NPPs were not designed to accommodate boiling in the pool; therefore a loss of cooling can be tolerated for about 16 hours before the structural design temperature is reached. Above this temperature there is an increasing risk of structural cracking which could lead to leakage from the bay. Any leakage will shorten the time to fuel uncovering. The Darlington IFB was designed to accommodate boiling and this finding does not apply to Darlington.

²⁸ Make-up is the provision of water to replace coolant inventory lost due to leaks or boil-off.

The CNSC Task Force recommends that licensees develop a strategy to mitigate these concerns by demonstrating that procedures and equipment are in place to provide make-up water that will compensate for possible leakage, and that manual actions can be performed in any high radiation fields that may arise from a low water level. The CNSC Task Force notes that upgrades to provide an enhanced make-up capability are already being considered. These upgrades should consider possible leakage arising from structural failures that may occur when the temperature limits are exceeded.

The licensees' submissions do not generally discuss the need for hydrogen mitigation in the IFB area. In their July 28, 2011, submission, licensees conclude that, as long as water inventory is maintained and the fuel remains submerged, hydrogen generation is not an issue. Nonetheless, the CNSC Task Force finds that the need for hydrogen mitigation in the IFB area should be evaluated.

6.3.7 Licensees' plans for design changes or further assessments

Since original construction, licensees have made many safety improvements to NPPs based on CNSC requirements, industry research, national and international operational experience and generally rising public expectations. In particular, licensees of those stations that have undergone refurbishment have performed a systematic review against modern standards and made modifications that reduce the likelihood and consequences of severe core damage and a large release of radioactive materials.

Notwithstanding the above, licensees have performed assessments against the lessons learned from the Fukushima accident and have proposed, or are evaluating, a number of further safety enhancements, such as additional coolant injection points, additional hydrogen mitigation, and additional onsite and offsite power supplies and pumps. The CNSC Task Force agrees that these enhancements have the potential to improve safety at the plants. More detailed plans and schedules were submitted by licensees in September 2011.

While accepting that the risk from Canadian NPPs is low, the CNSC Task Force identified some additional potential improvements or confirmatory assessments that could further reduce the risk or improve confidence in the ability of reactors to survive beyond-design-basis accidents. These are listed in section 6.3.8.

6.3.8 Review findings for beyond-design-basis accidents

The CNSC Task Force finds that the risk to the public from beyond-design-basis accidents and events at CANDU NPPs is very low. CANDU reactors have a large inventory of water available for passive cooling in the secondary cooling system, the primary cooling system, the moderator and the calandria vault / shield tank.

CANDU reactors have independent and diverse backup power supplies, and thus provide high confidence that power can be restored to vital equipment. With many days' supply of fuel for emergency power generators available onsite, adequate time is available to take long-term mitigating action.

While accepting that the risk from beyond-design-basis accidents at Canadian NPPs is very low, the CNSC Task Force identified a number of areas where additional improvements or confirmatory assessments would further enhance safety:

1. Not all licensees have completed the installation of passive autocatalytic recombiners. Most licensees have taken action to accelerate the installation.
2. Results of studies of the duration of primary boiloff before pressure tube failure are not consistent. The progression of a sustained loss-of-heat-sinks event described by licensees is in

- broad agreement with the CNSC's understanding. However, the CNSC Task Force assessment of the time available before pressure tube failure is shorter than that given by industry.
3. In the event of a loss of all normal, backup and emergency AC power, the guaranteed capability of Class I batteries to support all essential electrical equipment is 40 minutes (although it is recognized that some services will last much longer). This duration is short compared to other essential supply capabilities and gives little time to restore AC power. Once batteries are exhausted, most control and instrumentation functions are lost.
 4. While key instrumentation is fully qualified for design-basis accidents, survivability in beyond-design-basis accident conditions has not always been demonstrated.
 5. Degasser (bleed) condenser relief valves have been tested to ensure that they are capable of providing sufficient relief flow for worst-case design-basis accidents. However, they have not been tested at extreme conditions that may arise in beyond-design-basis accidents. In these cases, relief valve capacity may not be adequate in a sustained loss of all heat sinks, reducing the time before pressure tubes fail. The CNSC previously evaluated this issue and accepted the current design, although the margin to failure was small.
 6. Shield tank relief and calandria vault relief have not been verified to be adequate for beyond-design-basis accidents. A large inventory of water surrounds the core of a CANDU reactor – one of the strengths of its design. Nonetheless, if relief valves do not have sufficient capacity in a sustained loss of heat sinks, the shield tank could fail due to overpressure and much of the available water may be lost, leading to an earlier failure of the calandria vessel than would be the case if adequate relief was available.
 7. The minimum Class I/II equipment that is needed to mitigate beyond-design-basis accidents involving loss of all AC power has not been systematically identified.
 8. Modelling of severe accidents performed for multi-unit NPPs was based on a computer model that represents only a single unit. The modelling approach is accepted as adequately giving broadly representative results but would not be capable of calculating, for example, the effects of different times of core meltdown in the different units.
 9. The irradiated fuel bays (spent fuel pools) at most NPPs have temperature limits that lead to relatively short times (16 hours) for which a loss of cooling can be tolerated before the structural design temperature is reached. Above this temperature, an increasing risk of structural cracking could lead to leakage from the bay, thereby shortening the time to fuel uncovering. Additionally, with a low water level, it may not be possible to perform manual actions in elevated radiation fields.
 10. The need for hydrogen mitigation in the irradiated fuel bay area has not been adequately evaluated.

6.4 Severe accident management

A severe accident is a beyond-design-basis accident that involves significant core degradation. Severe accident management (SAM) is one of the components of defence in depth used in the overall safety assurance framework. SAM provides for the management of risks posed by unlikely events leading to severe accidents in an NPP. The CNSC's expectations for SAM are given in G-306, *Severe Accident Management Programs for Nuclear Reactors* [23], published in 2006.

The CNSC Task Force reviewed the licensees' provisions for using existing plant capabilities, complementary design features (such as passive autocatalytic recombiners, emergency containment filtered venting system, and calandria vault make-up) and emergency mitigating equipment²⁹ in the

²⁹ Emergency mitigating equipment includes portable equipment that may be available onsite or delivered to the site for the purpose of preventing and mitigating severe accidents.

management of a severe accident. The focus of accident management is on halting or delaying the progression of an accident leading to eventual cladding and/or containment failure. Plant monitoring and instrumentation survivability in severe accident conditions were also evaluated. Where additional equipment or design modifications were found to be necessary, the licensees' plans and schedules for implementation were assessed.

Severe accident management includes the development of guidance and procedures for use by plant personnel. The CNSC Task Force verified the status of severe accident management guidelines (SAMG) at Canadian NPPs. Where SAMG have not been fully implemented, the review focused on the licensees' plans and schedules for completion.

The CNSC Task Force also considered plans for the use of external resources, such as equipment, fuel and people, in mitigating severe accidents. Formal plans for inter-utility cooperation in matters such as availability of skilled personnel, provision of technical support and the sharing of equipment were included in this consideration.

All licensees provided their responses to the CNSC request for information pursuant to subsection 12(2) of the *General Nuclear Safety and Control Regulations*. This summary addresses the following topics in each of the licensees' submissions:

- status of SAMG implementation
- plant design capabilities for severe accident management
- assessments of severe accidents
- use of external resources
- irradiated fuel bays
- multi-unit considerations

Further elaboration is provided in sections 6.4.1 to 6.4.6.

6.4.1 Status of severe accident management guidelines

All Canadian NPPs have a comprehensive set of documentation covering normal plant operation, minor upsets, and accident conditions. As part of the SAMG development and implementation, the set of operating documentation is prepared to explicitly cover severe accidents. The SAMG suite includes a number of procedures and supporting documents, with the fundamental goals of:

- maintaining or restoring fuel cooling
- maintaining the integrity of the containment envelope
- minimizing releases of radioactive products to the environment

SAMG were developed by building both on the existing structure of emergency operating procedures and on international experience. A symptom-based approach is used to allow the plant personnel to identify suitable actions to bring the plant under a stable and controlled state.

The CNSC Task Force finds that the SAMG that the CANDU licensees are implementing are generally adequate, but need to be supplemented by explicit considerations of specifics for the multi-unit stations, events affecting spent fuel bays and severe accidents triggered by extreme external events.

6.4.2 Plant design capabilities for severe accident management

Plant design capabilities for severe accident management can be strengthened with complementary design features. A complementary design feature is a physical design feature added to the design as a

standalone structure, system or component (SSC) or added to an existing SSC to cope with plant conditions arising from selected beyond-design-basis accidents, including severe accidents.

Complementary design features include, for example:

- emergency containment filtered ventilation
- passive autocatalytic recombiners (PARs)
- make-up provisions for various water reservoirs, and other areas needing coolant

Emergency mitigating equipment may be employed and includes portable equipment either available on site or to be delivered from an offsite location. Additional, ad hoc means may be used to supplement the existing capabilities to address severe accidents.

6.4.2.1 Containment venting

All NPPs have the means to vent the containment to protect containment structural integrity. However, not all NPPs can filter the vented gases in severe accidents. Emergency containment filtered ventilation (ECFV) is a complementary design feature intended to protect the containment envelope if the internal containment pressure approaches the containment strength limit and to remove radioactive materials from any gases vented from the containment in a severe accident. Such a system has been installed, for example, at Point Lepreau; it is manually actuated, does not require an external source of power and is used to relieve containment pressure for the conditions that could be present in a severe accident. ECFV uses a high-efficiency scrubber and filtration unit to filter out the vast majority of fission products so radiation exposure to the public would be limited to acceptable levels in the event of a release. Similar venting provisions need to be considered for all other Canadian NPPs to provide a means to minimize the release of radioactivity while protecting the containment integrity.

6.4.2.2 Hydrogen management

Hydrogen combustion is a concern with respect to the integrity of the containment. Hydrogen can be produced in certain phases of severe accident progression. To deal with the hazard of large quantities of hydrogen being produced in a severe accident and causing hydrogen explosions, most CANDU plants are equipped with AC-powered igniters, which are intended to control hydrogen concentrations in the containment atmosphere by initiating limited “burns” before a potentially explosive concentration is reached. Recently, NPP licensees have initiated installation of passive autocatalytic recombiners (PARs). These are devices intended to passively (without the need of external power) remove hydrogen from the containment atmosphere. All Canadian NPPs have either installed PARs or are in the process of installation. The CNSC Task Force expects that all NPP licensees will provide confirmatory assessments demonstrating adequacy of PARs for severe accidents, and consider installation of PARs in the spent fuel bay areas.

6.4.2.3 Coolant make-up provisions

Make-up provisions (such as dedicated lines intended to replenish water inventory in important plant systems) are an important line of defence against accidents progressing to severe core damage. Water can be added to a variety of systems to prevent, slow down or terminate the core fuel degradation process. These systems include steam generators, calandria, shield tank, calandria vault and the spent fuel bay. Water is typically provided either by in-containment reserves (such as a dousing tank) or by an external connection to the reactor building. Keeping in mind that effective make-up for lost coolant may prevent core damage, the CNSC Task Force requests all licensees to perform a systematic assessment of all existing and potential means to provide make-up coolant to various

reactor systems. The potential for creating a path for unfiltered releases (containment bypass) through a make-up line needs to be critically assessed.

6.4.2.4 Plant monitoring and instrumentation

The existing plant monitoring and control instrumentation has been designed and maintained to ensure correct functional performance under the conditions assumed in the station design basis. Correct performance of key instrumentation is essential in diagnosing the plant state and emerging safety challenges, such as containment pressure buildup or hydrogen and fission product accumulation. Because beyond-design-basis and severe accident conditions are more severe, functioning of the existing instrumentation is not assured. Assessments of existing instrument survivability or of needs for installing hardened³⁰ instrumentation should be performed.

6.4.3 Assessments of severe accidents

Explicit assessment of severe accident progression is required to develop an understanding of likely challenges to key defence-in-depth systems (calandria, containment), timing of events, required coolant make-up capability, extent of fuel damage and the probable source term. Integral mechanistic models are available to simulate accident progression. All licensees either completed or are in the process of performing Level 2 PSAs as required by regulatory standard S-294, *Probabilistic Safety Assessment (PSA) for Nuclear Power Plants* [18], which involve deterministic analysis of credible severe accident scenarios. However, the existing modelling capabilities may not be adequate to consider events affecting multiple reactors on the same site (multi-unit events), accidents with spent fuel, or releases of radioactive products from a degraded reactor core into water. The assessments of severe accidents should be periodically updated, similar to the existing practice used for safety reports.

A focused review of beyond-design-basis accidents is given in section 6.3.

6.4.4 Use of external resources

External resources can be brought in to supplement or replace the onsite resources and may include fuel, water, electric power or equipment such as pumps or generators. The resources currently available to the licensees on site are adequate to cope with design-basis accidents and many beyond-design-basis events. In case of an external event affecting the whole site, or a severe accident, which will progress over several days, it would be necessary to bring in offsite resources. Explicit arrangements should be in place to facilitate access to additional resources.

6.4.5 Irradiated fuel bays

Fuel bays contain significant quantities of irradiated fuel. Because of decay, fission product inventories in the spent fuel decrease over time. Nevertheless, the long-lived radioactive materials could pose a significant threat if the spent fuel is uncovered and subsequently overheats. To mitigate this threat, provisions are taken to ensure reliable cooling of the spent fuel bays and to maintain their structural integrity in credible external events, such as earthquakes. The CNSC Task Force expects all Canadian NPP licensees to perform comprehensive deterministic and probabilistic analyses of events

³⁰ Hardened instrumentation is capable of surviving the harsh conditions of a severe accident.

affecting irradiated fuel bays, in order to demonstrate that the mitigation is sufficient for events as discussed in section 6.3.6.

6.4.6 Multi-unit considerations

As events at the Fukushima plant have demonstrated, the multi-unit plants face unique challenges. Specifically, events affecting more than one unit at a time need to be considered; such events would exacerbate challenges that the plant personnel would face in time of an accident. The events and consequences of an accident at one unit may affect the accident progression or hamper accident management activities at the neighbouring unit; available resources (personnel, equipment and fuel) would need to be shared among several units. Explicit plans should be in place to address these challenges.

6.4.7 Review findings for severe accident management

All NPP licensees undertook a review of the existing procedural guidance and design capabilities of operating NPPs to cope with accidents involving significant core damage. The soundness of the provisions in place has been confirmed. At the same time, several possibilities for further enhancements have also been identified.

In particular, the CNSC Task Force is satisfied that:

- Severe accident management guidance has been, or will shortly be, fully implemented at all plants. This includes development of procedural guidance to the operating staff and technical support groups, specific training and appropriate drills.
- In addition to original design capabilities, which already catered to mitigation of some beyond-design-basis accidents, further design improvements have either been implemented or are being planned. Notably, a filtered venting system for containment, qualified for severe accident conditions, can prevent challenges to containment integrity and minimize the release of radioactive materials. Diversifying the coolant make-up capabilities will further increase the capacity of available heat sinks and thus delay any reactor core degradation. Another positive development is the acceleration of installation of the hydrogen passive autocatalytic recombiners.
- All NPP licensees have completed or are working on analyses of severe accidents, as part of the effort to comply with regulatory standard S-294, *Probabilistic Safety Assessment (PSA) for Nuclear Power Plants*.
- The NPP licensees are cooperating in establishing formal agreements and designating or building a regional warehouse to provide necessary equipment and resources in case of emergency.

The CNSC Task Force also appreciates that all utilities have clear guidance in place that assigns responsibility for decisions regarding containment venting to the plant operator.

Based on the reviews of the submitted information, the CNSC Task Force has identified several findings, most of which are common to all licensees. These review findings identify a need either for additional information on the already ongoing activities, or for licensees to consider further enhancements to the capability of power plants to cope with severe accidents.

The CNSC Task Force finds that:

1. Current assessments do not adequately consider events affecting multiple reactors on the site, events at spent fuel bays, as well as events triggered by extreme external hazards. Having detailed assessments of the severe accident management procedural guidance and design

- capabilities to cater to beyond-design-basis and severe accidents were shown to be of high priority during the Fukushima event.
2. Plant design capabilities for severe accident management, such as containment venting, hydrogen mitigation, coolant make-up provisions, instrumentation, and the control areas have not been fully evaluated and documented. Such design capabilities would allow minimization of the consequences of a severe accident, should one occur.
 3. The scope of analyses of severe accidents does not fully cover accidents triggered by extreme external events, multi-unit events, and spent fuel bay accidents. The modelling capabilities for multi-unit events are not fully adequate. Improvements would also give a better estimation of the source terms of radioactivity and combustible gases.
 4. Licensees' emergency response organizations do not have access to a regional warehouse that could make available offsite equipment and resources that may be needed in case of a severe accident. Availability of emergency equipment was shown to be crucial during the Fukushima event and could allow terminating a severe accident early enough to prevent any radioactive releases to the environment.
 5. Severe accident analyses and assessments of external hazards are not systematically produced and periodically updated. This aspect of the plant safety case has not received much attention in the past and was shown to be important in understanding the site-specific challenges and possible progression of a severe accident.

The CNSC Task Force also finds that, in relation to the regulatory framework in the areas related to plant design for severe accidents, as well as to the management of accidents:

6. Current power reactor operating licences do not have specific licence conditions requiring implementation of accident management provisions, including those for severe accidents.
7. Relevant sections in the existing and planned regulatory documents, such as G-306, *Severe Accident Management Programs for Nuclear Reactors*; RD-310, *Safety Analysis for Nuclear Power Plants*; and RD-337, *Design of New Nuclear Power Plants*, have not been re-evaluated and revised to account for the lessons learned following the Fukushima accident. There is currently no regulatory document giving specific requirements for accident management.

6.5 Emergency response

This section of the review addresses the licensees' responsibilities for emergency response. Section 7 of this report deals with the current status of emergency preparedness and response measures in Canada.

The CNSC Task Force reviewed the NPP licensees' submissions against its *Nuclear Power Plant Safety Review Criteria* for emergency response, and:

- the *Nuclear Safety and Control Act*
- section 6(k) of the *Class I Nuclear Facilities Regulations*
- applicable site-specific licences
- CNSC guidance document G-225, *Emergency Planning at Class I Nuclear Facilities and Uranium Mines and Mills* (based on IAEA standard GS-G-2.1, *Arrangements for Preparedness for a Nuclear or Radiological Emergency* [24])
- regulatory document RD-353, *Testing the Implementation of Emergency Measures* [25]

In addition, all licensees' nuclear emergency preparedness programs and plans were reviewed against the requirements of their respective provincial offsite emergency response plans.

As required by the CNSC *Nuclear Safety and Control Act* and CNSC Regulations, all licensees of Class I nuclear facilities must provide information pertaining to their proposed emergency measures

and must include them in their respective licence applications. The information included in the applications describes the proposed facility, activities, substances and circumstances to which their emergency plans apply. The emergency plans should also be commensurate with the complexity of the associated undertakings, and the probability and potential severity of the emergency scenarios associated with the operation of these facilities. Therefore, these emergency plans must contain a description of the proposed measures to prevent or mitigate the effects of accidental releases of nuclear and/or hazardous substances on the environment, the health and safety of persons, and the maintenance of security, including measures to notify and assist offsite authorities and test the implementation of these measures.

Licensees regularly review their emergency plans and revise them to address changes in their operational activities as well as to take into account other relevant factors and circumstances such as operating experience. A licensee's emergency plan must be accepted by the CNSC in order for an NPP to be licensed.

Each licensee's emergency plan is specific to its particular site and organization; however, they all typically cover the following topics:

- documentation of the emergency plan
- basis for emergency planning
- personnel selection and qualification
- emergency preparedness and response organizations
- staffing levels
- emergency training, drills and exercises
- emergency facilities and equipment
- emergency procedures
- assessment of emergency response capability
- assessment of accidents
- activation and termination of emergency responses
- protection of facility personnel and equipment
- interface arrangements with offsite organizations
- arrangements with other agencies or parties for assistance
- recovery program
- public information program
- public education program

For more detailed information about the contents of emergency plans for Class I nuclear facilities, refer to the CNSC regulatory guidance document G-225, *Emergency Planning at Class I Nuclear Facilities and Uranium Mines and Mills* [26].

6.5.1 Adequacy of emergency plans for beyond-design-basis or multi-unit accidents

The current emergency plans for all NPPs in Canada exceed the requirements for design-basis accidents for emergency planning; this means that design-basis accidents would not cause offsite dose consequences. However, all licensees routinely conduct exercises to simulate scenarios with offsite effects that would subsequently require the provinces to activate their provincial plans and implement local area evacuations. The emergency scenarios needed to trigger this degree of response are in fact beyond-design-basis types. Therefore, they demonstrate that the licensees' emergency response programs are capable of dealing with a beyond-design-basis accident.

The CNSC Task Force is confident that the licensees' emergency response organizations are capable of responding to beyond-design-basis events provided they are single-unit accidents only. None of the multi-unit station licensees, however, have explicitly considered multi-unit accident scenarios in development of their emergency plans.

6.5.2 Integration of SAMG in emergency response organizations

The integration of SAMG into emergency plans, for those licensees who have implemented SAMG, is effective. In practice, this integration offers enhanced technical support to the emergency response organizations, and the additional staff are integrated into the existing structure.

6.5.3 Alternate emergency facilities

All licensees have stated that they have alternate locations identified for their emergency centres. However, this is not always documented in their emergency plans and procedures. Although some licensees indicated their primary emergency facilities are designed to withstand design-basis external hazards and/or meet the relevant commercial or industrial building code, none provided information regarding the robustness of their alternate facilities.

The CNSC Task Force finds that, in some cases, information is lacking about the robustness of licensees' primary facilities, and that none of the licensees have robustness criteria for their alternate facilities.

6.5.4 Availability of support and supplies

In all cases, the licensees have indicated that they have agreements in place with their respective stakeholders for support and supplies. However, with few exceptions, arrangements for supplies or services have not been consistently formalized or documented in their emergency plans and procedures. All licensees mentioned in their submissions that they are working together, through a CANDU Owners Group working group, to develop and formalize an industry-wide "mutual assistance" agreement.

6.5.5 Capability without external power

Not all licensees' emergency facilities and equipment have backup power available in the event of a loss of external power. Those licensees that do have them, however, know and understand the limitations of their backup power supplies and are now evaluating and investigating their ability to maintain backup power for extended outages. Those that do not have backup power for their emergency facilities and/or equipment are aware of this weakness and are working towards correcting this shortcoming. Also, in some cases, the information regarding backup power for all emergency centres and/or equipment is not fully documented in their emergency plans and procedures. The licensees need to include this information to ensure that response personnel know the limitations of their facilities and what arrangements are in place to replenish fuel for generators.

Emergency facilities and equipment that are designated as essential for emergency response must always be available, accessible and ready to operate. Therefore, the absence of reliable and backup sources of power from any emergency facilities or equipment is a weakness that must be corrected. The CNSC Task Force acknowledges that those licensees who have identified weaknesses in this area are in the process of assessing their needs and options.

6.5.6 Source term estimation

Post-accident source term estimation is a method that can be used to quantify a potential release of radioactive material before it occurs. Both Bruce Power (BP) and Ontario Power Generation (OPG) use software and in-plant gamma survey measurements to perform post-accident source term estimations; however, these are designed for an accident in only one unit. Hydro-Québec and New Brunswick Power (NB Power) do not perform source term estimation in support of offsite emergency response. Source term estimation is a “best practice” and it would be beneficial if all licensees were able to provide source term information to offsite authorities in emergency situations.

6.5.7 Plume dispersion and dose modelling

All licensees have plume modelling capability that can be used to guide field survey teams and to inform offsite authorities about the area that radiation releases may spread to in the event of an accident.

The approach to dose modelling is different across all licensees. BP and OPG perform dose modelling based on source term estimates, the monitoring of venting radiation, and field surveys. Hydro-Québec performs dose modelling based on the monitoring of venting radiation, fixed radiation surveillance station data and field surveys. NB Power does not perform dose modelling.

The multi-unit site licensees have indicated that their software is capable of providing plume modelling for multi-unit events as plume modelling is independent of the source term. However, dose modelling is directly affected by the source term and, therefore, dose modelling for multi-unit scenarios will need to be re-assessed to ensure accuracy.

The CNSC Task Force finds that all licensees have plume modelling capability. In regard to dose modelling to support offsite authorities, Hydro-Québec should ensure that source term estimates are included in dose modelling, and NB Power should develop comprehensive dose modelling.

6.5.8 Station boundary and field radiation monitoring

All Canadian NPP licensees perform field radiation monitoring by dispatching dedicated monitoring teams to designated locations, both onsite and offsite, to collect measurements using gamma dose rate meters and air samplers as determined by the plume modelling results. Only one licensee, Hydro-Québec, has an automated system that provides real-time field monitoring data in addition to the results collected by its field monitoring teams. In all cases, field radiation monitoring results are relayed to the provincial authorities, as well as the CNSC, to be used by the offsite authorities to assess and to determine what protective actions should be recommended for the public. Some other licensees have identified the use of automated boundary monitoring and are assessing the potential benefits of installing such instrumentation.

The CNSC Task Force considers that all licensees have satisfactory arrangements in place to perform field radiation monitoring. However, for most licensees, the current method depends on station staff physically going into the field to collect samples and take readings. The use of automated real-time field monitoring at a station boundary is seen as a best-practice approach that allows critical data to be available sooner to appropriate authorities.

6.5.9 Containment venting process

There are two containment venting strategies: nominal containment venting, which keeps containment pressure below its structural limit, and alternate containment venting, which is a coordinated process involving offsite stakeholders to determine the optimal venting strategy to protect the public and the environment.

In all cases, the senior authorized person on shift (e.g., shift manager, shift supervisor, chef de quart) is fully authorized to perform nominal venting. If nominal venting is not required, NPP staff coordinate with offsite authorities before venting. The CNSC Task Force is satisfied that the containment venting decision process and authority is effective and is appropriately documented by the licensees.

6.5.10 Coordination of communications

Communications protocols between the licensees and the offsite response organizations, including provinces, municipalities and the CNSC, are well documented in both the licensees' emergency response plans and procedures, and those of the offsite organizations. During the planning and preparedness phases of emergency management, all licensees work closely with their respective offsite emergency response stakeholders to maintain good working relationships. In addition, the provinces, the Government of Canada and the licensees work cooperatively through joint emergency information centres to provide the public and the media with information about the status of the crisis and other relevant information.

The CNSC Task Force finds that the current coordination of communications between licensees and offsite authorities, related to decision making and public/media affairs, is well established and functions efficiently, as has been observed during coordinated exercises between licensees and their respective offsite organizations.

6.5.11 Review findings for emergency response

The CNSC Task Force has verified that there are no significant gaps in emergency planning at Canadian NPPs. Overall, the licensees maintain and operate comprehensive and well-documented emergency plans, and these plans and their elements are regularly tested through self-audited drills and exercises. The CNSC also conducts inspections of these exercises and verifies that both the onsite and the offsite support components of the licensees' emergency response plans have been adequately implemented.

Although a number of opportunities for further enhancement are listed below, the emergency response program documentation, plans and procedures for all NPPs in Canada are meeting the expectations and intent of CNSC guidance and regulatory expectations, as well as their site-specific licences and the requirements of their respective provincial offsite emergency response plans. There are no emergency response issues that require immediate action.

The CNSC Task Force finds that:

1. Emergency response organizations are capable of responding to single-unit, beyond-design-basis events. Evaluation and revision of emergency plans in regard to multi-unit accidents and severe external events, including an assessment of the minimum complement requirements, have not been performed. As a result, it has not been conclusively demonstrated that emergency response organizations will be capable of responding effectively in a severe event and/or multi-unit accident.

2. The performance of the emergency response organization under severe event and/or multi-unit accident conditions has not been challenged by designing and conducting exercises that are based on such conditions.
3. Automated real-time station boundary radiation monitoring systems with appropriate backup power and communications systems are seen as a best practice approach and allow critical data to be available rapidly. However, such systems are not available at all sites.
4. Not all licensees' emergency facilities and equipment have backup power available in the event of a loss of external power. Backup power sources for primary and alternate emergency facilities, and all emergency response equipment that require electrical power to operate (e.g., electronic dosimeters, two-way radios), have not been systematically identified. The applicable emergency plans and procedures do not, in all cases, adequately document the requirements and limitations.
5. Arrangements and agreements for external support are not always formalized and not always documented in the applicable emergency plans and procedures.
6. Hydro-Québec does not currently have source term estimation capability included in its dose modelling tools. NB Power does not currently have source term and dose modelling tools.

As a result of this assessment of licensees' emergency preparedness and response programs, it has become apparent that the main cross-cutting issue for this focused report is in the regulatory framework area. Each licensee has its own means and methods of meeting the emergency preparedness and response expectations, and there is no regulatory requirement or standard to ensure consistency among the licensees. This is a common theme in many emergency preparedness areas since the current CNSC emergency preparedness criteria are based on a CNSC guidance document: *G-225, Emergency Planning at Class I Nuclear Facilities and Uranium Mines and Mills*. Converting the CNSC "guidance" document to a CNSC "regulatory" document, and adding more detailed and specific requirements, could be the basis for strengthening and standardizing emergency preparedness and response at NPPs in Canada.

In addition, whereas a licensee's onsite emergency plans are submitted to the CNSC as part of the licence application and renewal process, there is no formal requirement for the CNSC to review the offsite plans. Although the CNSC has always considered the preparedness of the offsite authorities when reviewing a licence application, the requirement is not explicit and poses a potential gap.

As a result, the CNSC Task Force also finds that:

7. The suite of emergency preparedness regulatory requirement documents, currently comprising guidance document *G-225, Emergency Planning at Class I Nuclear Facilities and Uranium Mines and Mills*, and regulatory document *RD-353, Testing the Implementation of Emergency Measures*, are lacking detailed and specific requirements needed to strengthen and standardize emergency preparedness and response in Canada.

7 Nuclear Emergency Management in Canada

This section of the review addresses the current status of emergency preparedness and response measures in Canada, specifically the offsite preparedness and response. The *Nuclear Power Plant Safety Review Criteria* generally exceed the applicable requirements and expectations of the current CNSC regulatory framework. The CNSC Task Force review findings in this section relate exclusively to the lessons learned from the Fukushima accident. The licensees' onsite preparedness and response is addressed in section 6.5.

The management of a nuclear emergency in Canada involves overlapping municipal, provincial and federal jurisdictions. The CNSC Task Force reviewed the plans and capabilities of lead provincial and

federal agencies to identify any outstanding issues related to coordinated nuclear emergency management. The review included ensuring that agencies’ responsibilities and communications channels have been defined and that information needs are well established. Review findings related to further improvements are given, where applicable.

In addition, the review of international lessons learned has identified the following topics related to emergency response:

- enhancement of coordination between federal, provincial and municipal authorities
- international considerations in an emergency

Figure 7.1 shows the stakeholders involved in managing a nuclear emergency and their linkages. In simple terms:

- Onsite preparedness and response is the responsibility of the NPP licensee.
- Offsite preparedness and response is the responsibility of the province, in coordination with municipalities, where the NPP is located.
- At the request of the province, the Government of Canada will provide support to the province via the resources of multiple federal agencies.
- The CNSC continues to have regulatory oversight of the licensee during an emergency.

Figure 7.1 Nuclear Emergency Management Stakeholders

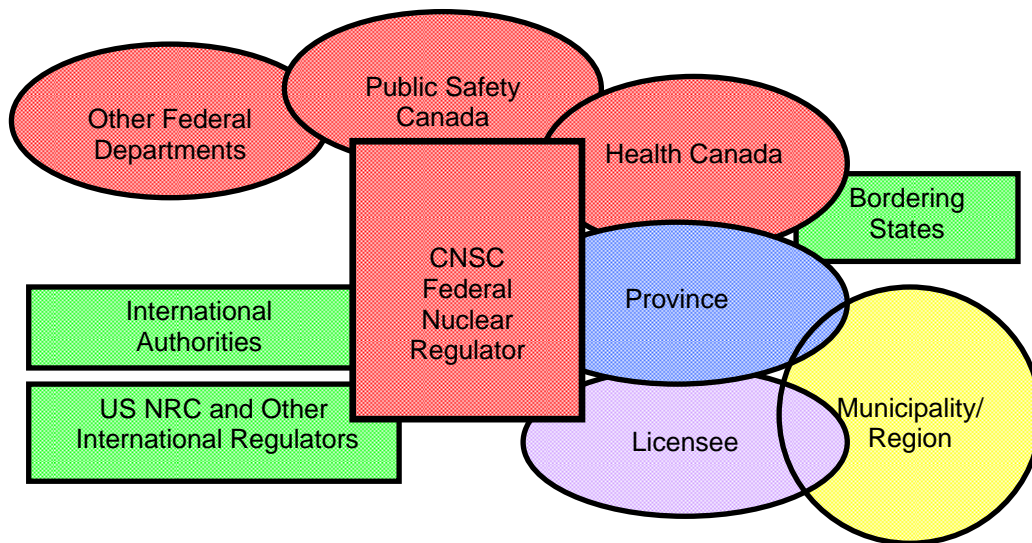

7.1 Nuclear power plant licensees

The *Nuclear Safety and Control Act* empowers the CNSC to establish a comprehensive licensing and compliance system to assure health, safety, security and protection of the environment. It also requires the nuclear industry to protect its workers and the public from unacceptable levels of radiation.

In particular, the *Class I Nuclear Facilities Regulations* require NPP licensees to maintain onsite emergency plans and a response capability. In addition, licensees must also provide support to offsite authorities in their planning and response to a nuclear emergency with offsite consequences.

Emergency plans and programs are reviewed by the CNSC. They become binding upon the licensee, as a condition in the operating licences, and are subject to the CNSC's licensing and compliance oversight processes.

7.2 Government of Canada

The following federal departments play a major role in managing a nuclear emergency.

7.2.1 Health Canada

Health Canada (HC) is designated as the lead agency for federal nuclear emergency preparedness. In this context, Health Canada's Radiation Protection Bureau is specifically resourced for this responsibility and the department maintains and administers the *Federal Nuclear Emergency Plan* (FNEP) [27]. It should be noted that Health Canada was assigned this responsibility prior to the introduction of the *Emergency Management Act* [28] and prior to the creation of Public Safety Canada as a federal department for coordinating the federal whole-of-government approach to emergency management.

The FNEP is intended to complement the relevant nuclear emergency plans of other jurisdictions inside or outside of Canada. It describes the measures federal departments and agencies should follow to manage and coordinate the federal response to a nuclear emergency. The FNEP can be activated if federal support to a Canadian province or territory is required, as a consequence of any domestic, trans-boundary or international incident.

The FNEP describes the roles and responsibilities of federal departments and agencies. The FNEP primarily addresses preparedness and response. It does not address the recovery phase. In addition, annexes to the FNEP describe interfaces between the Government of Canada and the provincial emergency management organizations in the provinces that host NPPs (Quebec, Ontario and New Brunswick). The FNEP has not been tested in a full-scale national exercise since 1999.

The FNEP was last updated in 2002. Accordingly, it does not reflect the introduction of the *Emergency Management Act* and the role of Public Safety Canada as the lead federal department responsible for coordinating federal response to an emergency. Similarly the Federal Emergency Response Plan (FERP), administered by Public Safety Canada, does not refer to the FNEP. A memorandum of understanding between Health Canada and Public Safety Canada on the use of the FNEP was put in place as a temporary measure.

Health Canada began a process to update the FNEP in 2011. There is ongoing effort and consultation between Health Canada, Public Safety Canada and other federal departments to review and update the FNEP and to align it with Public Safety Canada plans and responsibilities.

In addition to managing the FNEP, Health Canada is responsible for operating various radiological monitoring networks: the Fixed Point Surveillance Network, the Canadian Radiation Monitoring Network and the Canadian Comprehensive Test-Ban Treaty (CTBT) Radiation Monitoring Network.

7.2.1.1 Fixed Point Surveillance Network

The Fixed Point Surveillance Network is the result of a project to build a real-time radiation detection system across Canada. This network monitors public doses from radioactive materials in the air and would also help make Canada better prepared in case of nuclear or radiological incidents.

The network consists of radiation detection equipment located at 77 locations across the country and a single data centre that collects, analyzes and stores the data measured at each of these monitoring stations. This data centre is located at Health Canada's Radiation Protection Bureau in Ottawa and communicates with the stations on a daily or as-needed basis. Currently, the network includes monitoring stations installed by Health Canada plus several stations that are owned and operated by industrial partners who share their data with Health Canada.

7.2.1.2 Canadian Radiation Monitoring Network

The Canadian Radiation Monitoring Network is a national network of monitoring stations that routinely collect air, precipitation, drinking water, atmospheric water vapour, and milk for radioactivity analysis and measure external gamma dose. This network was initiated in 1959 to monitor environmental releases of radioactivity from atmospheric nuclear weapons testing and accidental releases from nuclear facilities.

Currently, the network provides information on natural background radiation levels, and provides a mechanism for measuring routine or accidental releases of radioactivity in the environment. There are 26 environmental monitoring stations, plus additional sites in the vicinity of nuclear reactors.

7.2.1.3 Comprehensive Test-Ban Treaty Radiation Monitoring Network

Since 1998, Health Canada has been contributing to the International Monitoring System, an element of the Verification Regime overseen by the Comprehensive Nuclear Test-Ban Treaty Organization (CTBTO). This compliance treaty seeks a universal ban on all nuclear detonation as an effective means to stop further development of nuclear weapons.

Canada is responsible for the installation and operation of four CTBTO radiation monitoring stations across the country as well as a radionuclide laboratory. Health Canada's Radiation Protection Bureau is responsible for the radionuclide laboratory and monitoring stations at St. John's, NL; Yellowknife, NT; Vancouver, BC; and Resolute, NU. These installations collect and transmit monitoring data to the CTBTO to monitor for evidence of any nuclear explosion. However, the data can also be used for a national response to nuclear emergencies.

7.2.2 Public Safety Canada

Under the *Emergency Management Act*, the Minister of Public Safety is responsible for coordinating the Government of Canada's response to an emergency. The *Federal Emergency Response Plan* (FERP) [29] outlines the processes and mechanisms to facilitate an integrated Government of Canada response to an emergency and to eliminate the need for federal government institutions to coordinate a wider whole-of-government response.

The FERP is designed to harmonize federal emergency response efforts with those of the provinces and territorial governments, non-government organizations and the private sector.

In addition, the Minister of Public Safety is responsible for promoting and coordinating emergency management plans of federal departments and agencies. All federal ministers are responsible for developing emergency management plans in relation to risks in their areas of accountability. Individual departmental activities and plans that directly or indirectly support the FERP's strategic objectives contribute to the integrated Government of Canada response.

As previously stated, the FNEP (led by Health Canada) and the FERP (led by Public Safety Canada) are not completely integrated, and a memorandum of understanding between Health Canada and

Public Safety Canada on the use of the FNEP was put in place as temporary measure. There is an ongoing effort and consultation between Health Canada and Public Safety Canada to address the integration of both plans.

7.2.3 Other federal stakeholders

There are 19 federal departments and agencies involved under the FNEP. The roles of two of them, Health Canada and Public Safety Canada, are described above. In keeping with the FNEP, federal policies and legislation, the remaining 17 federal departments and agencies listed in the FNEP are also responsible for independently developing, maintaining and implementing their own nuclear emergency response plans.

Several federal departments and agencies have designated responsibilities under the *Federal Nuclear Emergency Plan*.

7.2.4 Summary – Government of Canada

- A comprehensive federal nuclear emergency plan (FNEP) is in place to address preparedness and response.
- The FNEP has not been updated since 2002 and does not reflect the changes in responsibilities associated with the creation of Public Safety Canada and the *Emergency Management Act*.
- The effectiveness of the FNEP has not been tested in a full-scale national exercise since 1999.
- The federal nuclear emergency management plans, procedures and arrangements primarily address preparedness and response. There are no guidelines and plans for the recovery phase.

7.3 Provincial governments

The provincial governments are responsible for overseeing the health, safety and welfare of their inhabitants and the protection of the environment. Accordingly, they assume lead responsibility for the arrangements necessary to respond to the offsite effects of a nuclear emergency by enacting legislation, maintaining emergency plans and procedures, and providing direction to the municipalities. In addition, the provincial governments coordinate support from the licensees and from the Government of Canada during the preparedness activities as well as during the response.

The provinces, in cooperation with the local jurisdictions, have established procedures to deal with any significant offsite nuclear impacts, primarily related to providing for urgent protective action.

These procedures include:

- limiting access to the affected zone(s)
- providing temporary shelter to the affected population
- evacuating buildings or premises in areas near the NPP
- blocking thyroid uptake of radiation
- implementing ingestion control measures such as quarantining farm animals, banning the sale of affected foodstuff, and restricting the use of affected drinking water
- establishing emergency worker centres and reception centres

7.3.1 Ontario

The Province of Ontario's *Emergency Management and Civil Protection Act* [30] governs emergency preparedness and response in Ontario. This legislation requires the government to formulate an emergency plan for emergencies arising in connection with NPPs. Emergency Management Ontario (EMO) is the lead organization for coordinating all the aspects of nuclear emergency management.

7.3.1.1 Plans

Ontario's nuclear emergency plans are structured as a *Provincial Nuclear Emergency Response Plan* (PNERP) Master Plan [31] with NPP-specific implementing plans. The PNERP Master Plan is the overarching plan giving the general principles, concepts and organization for the nuclear emergency management. The PNERP implementing plans for Pickering, Darlington and Bruce address site-specific aspects. PNERP planning, however, is based on a single-unit accident and does not explicitly consider multi-unit accidents.

EMO chairs the Nuclear Emergency Management Coordinating Committee (NEMCC), which comprises members from the NPPs, designated municipalities/region, ministries and federal departments and agencies such as the CNSC, Health Canada and Public Services Canada. This committee meets quarterly to discuss issues of mutual interest pertaining to nuclear emergency management in Ontario.

The PNERP Master Plan and the implementing plans for Pickering, Darlington and Bruce NPPs were last updated and approved by the Ontario Cabinet in 2009.

7.3.1.2 Planning zones

The planning zones used by the Province of Ontario are each generically described as being a certain radial distance from the NPP, but in practice they are defined in a geographically logical manner. For NPPs in Ontario, the following planning zones are used:

- **Contiguous zone** is the offsite area immediately surrounding the nuclear facility where an increased level of preparedness and response is required (nominally 3 km).
- **Primary zone** is the area around the nuclear facility where exposure control measures may be required (nominally 10 km). The approximate population is 7,500 in the Bruce primary zone, 122,000 in the Darlington primary zone and 261,000 in the Pickering primary zone.
- **Secondary zone** is the area where ingestion control measures may be required (50 km).

7.3.1.3 Event assessment

The NPP licensee is required to communicate the following information to the Provincial Emergency Operations Centre, initially, and then on an hourly basis:

- categorization of the accident
- status of safety systems and containment
- repressurization estimates or reactor/vacuum building pressures
- source term estimates
- field monitoring data
- weather data (current and forecast)

The Scientific Section at the Provincial Emergency Operations Centre has the required expertise and the required software to use data provided by the NPP licensee to perform plume modelling and projection of the likely offsite effects. This provides a valuable assessment of an event on an ongoing

basis and helps the Provincial Emergency Operations Centre to decide on the appropriate protective measures. Health Canada, the CNSC and the provincial ministries of Labour and the Environment are also represented at the Scientific Section. This enables the section to also incorporate the technical advice and data coming from these organizations.

7.3.1.4 Public alerting

A 2009 update to the PNERP now requires that the entire primary zone population must be able to receive alerts within 15 minutes. As per the provincial standards defined in the PNERP, the population within the 3 km radius requires a very stringent notification due to proximity to the hazard – the capability to alert practically 100 percent of the population both indoors and outdoors at any time of the day or year. The population within the remainder of the primary zone (3–10 km) must be notified on an area-wide basis – the signal will cover that geographical area, but does not presume notification of practically 100 percent of the population. The new requirements for indoor public alerting in Durham region are not yet being met.

7.3.1.5 Protective measures

The PNERP addresses exposure control measures to protect against external irradiation and inhalation of radioactive material. Measures include evacuation, sheltering, and thyroid blocking with stable iodine in potassium iodide pills (KI pills). The PNERP also addresses ingestion control measures, such as protecting the food chain from radioactive material and preventing the ingestion of contaminated food and water.

In particular, the PNERP requires designated municipalities (Durham Region, City of Toronto and Municipality of Kincardine) to facilitate the availability of KI pills for the primary zone institutions, emergency centres and for any member of the zone population who wishes to possess a supply. However, the mode of distribution is left to the designated municipalities to determine.

In all cases in Ontario, the designated communities have stocked the pills for the general public at central locations (pharmacies in Durham, reception centre in Kincardine) and have pre-distributed the pills to locations such as schools and long-term care facilities. The KI pills are not pre-distributed to households, although the general public can obtain them from pharmacies at any time.

The decision to implement the administration of KI would be taken by the Chief Medical Officer of Health for Ontario. The directive to obtain and ingest would then be issued through the Provincial Emergency Operations Centre’s emergency bulletin and emergency information systems.

7.3.1.6 Summary – Ontario

- Ontario has a comprehensive and up-to-date nuclear emergency response plan.
- Ontario’s PNERP is well integrated with NPP emergency plans.
- Ontario has set the most stringent requirements for public alerting among the provinces with NPPs.
- The requirements for indoor public alerting in Durham region are not being met. In addition, the implementation of the new 10 km public alerting requirement has just recently begun.
- Ontario has a Nuclear Emergency Management Coordinating Committee (NEMCC) comprising all municipal/regional, provincial and federal stakeholders. This forum provides an opportunity to discuss issues pertaining to the nuclear emergency management on a quarterly basis.
- The last full-scale nuclear exercise in Ontario was in 2007.

- Ontario is the only province in which KI pills are not pre-distributed to households in the designated planning zones.
- PNERP planning is based on a single-unit accident and does not explicitly consider multi-unit accidents.

7.3.2 Quebec

In the Province of Quebec, the *Plan national de sécurité civile du Québec* [32], in accordance with the Quebec provincial *Loi sur la sécurité civile* [33], provides the terms of reference for all emergencies. The Organisation de la sécurité civile du Québec (OSCQ) is responsible for emergency planning and the government response to all hazards.

The provincial nuclear emergency plan, *Plan des mesures d'urgence nucléaire externe à la centrale nucléaire Gentilly-2* (PMUNE-G2), addresses the specifics of planning and response for a nuclear emergency.

The last full-scale nuclear exercise in Quebec was in 2005.

7.3.2.1 Plans

The provincial PMUNE-G2 addresses the specifics of planning and response for a nuclear emergency. It is composed of a master plan (plan directeur) and sub-plans (lignes directrices).

The PMUNE-G2 defines the government ministries and agencies that have responsibilities in a nuclear emergency at the Gentilly-2 NPP. It describes the objectives of minimizing the consequences, protecting the public and providing support to the municipalities. At the regional level, the Direction générale de la sécurité civile et de la sécurité incendie is responsible for preparing and maintaining the PMUNE-G2. The coordination for the health portfolio is carried out by the Agence de la santé et des services sociaux de la Mauricie et du Centre-du-Québec. Its mission is to offer the necessary health services to protect the lives and the health of individuals who are facing the crisis.

Under the PMUNE-G2, the OSCQ would open the government operations centre in Québec City to coordinate the actions of the various government organizations in the province to maintain a link with the federal departments and agencies. A regional response centre located in Trois-Rivières would be open by the Organisation régionale de sécurité civile (ORSC) to coordinate local responses and provide support to the affected municipalities.

The original PMUNE-G2 master plan was released in 1996. A revision process was started in 2005. A revised plan is under review and expected to be formally approved by the end of 2011.

7.3.2.2 Planning zones

The planning zones used by the Province of Quebec are each generically described as being a certain radial distance from the NPP, but in practice they are defined in a geographically logical manner. The planning zones defined by the provincial plan (PMUNE-G2) are as follows:

- **Plume exposure planning zone** (Zone de planification d'urgence pour l'exposition au panache: ZPU-P) is an area around the NPP where the emphasis is on exposure control measures (nominally 8 km). The approximate population in the G2 ZPU-P is 10,000.
- **Ingestion planning zone** (Zone de planification d'urgence pour l'exposition par ingestion: ZPU-I) is an area around the NPP where the emphasis is on the ingestion control measures (nominally 70 km).

7.3.2.3 Accident/event assessment

The ORSC has the capability to run plume modelling through software and predict the offsite effects. As per the PMUNE-G2, the ORSC recommends the protective actions for the public and the environment.

These calculations and recommendations are done by the ORSC's radiological risk assessment team (or Équipe d'évaluation du risque radiologique) in the ORSC headquarters in Trois-Rivières. They use real-time plant measurements to predict the offsite effects.

7.3.2.4 Public alerting

Public alerting is the responsibility of the municipalities. The municipalities perform alerts by organizing first responders to go door to door and by issuing media notifications. There is no provincially mandated time requirement, although the PMUNE-G2 indicates it should be done as quickly as possible.

The Municipality of Bécancour, with assistance from Hydro-Québec, is investigating the use of an automated system to alert the residents living in the 8 km zone.

7.3.2.5 Protective measures

The PMUNE-G2 lists exposure control measures, such as evacuation, sheltering, and thyroid blocking (KI pills), to protect the public against external irradiation and inhalation of radioactive material. The PMUNE-G2 also addresses ingestion control measures, such as protecting the food chain from radioactive material and preventing the ingestion of contaminated food and water. As per the *Loi sur la sécurité civile*, it is the responsibility of the municipalities of Quebec to develop and maintain a plan which contains protective measures to take when faced with an emergency.

In particular, stable iodine tablets (KI) are pre-distributed to the residents within the plume exposure planning zone (8 km), and a comprehensive public information program for KI and other protective measures is in place. In addition, KI pills are stocked in locations such as daycare centres, schools and provincial and municipal centres. The decision to recommend the use of tablets by the population is made by the Regional Director of public health. The provincial Service Québec department and the municipalities are responsible for retransmitting this directive to the public through first responders (police, firefighters) and the media (radio, TV).

7.3.2.6 Summary – Quebec

- Quebec has a comprehensive nuclear emergency response plan. A revision is expected to be approved later this year.
- The planning basis adopted by Quebec is in depth and recent.
- Quebec's PMUNE-G2 is well integrated with Hydro-Québec-G2's emergency plan.
- There is no provincially set requirement for public alerting in Quebec.
- Currently, the municipality of Bécancour relies on using first responders going door to door and on issuing notifications through the media to alert the public. The municipality is investigating use of an automated system.
- The last full-scale nuclear exercise in Quebec was in 2005.

7.3.3 New Brunswick

The primary agencies for emergency management and public security in the Province of New Brunswick are the New Brunswick Emergency Measures Organization (NB EMO) and the New Brunswick Security and Emergencies Directorate (NB SED). NB EMO is the provincial lead agency for emergency management and business continuity, including radiological and nuclear emergencies. The NB SED is the provincial lead agency for security and the protection of critical infrastructure. These two agencies consolidate their efforts under the mandate of the New Brunswick Department of Public Safety.

The last full-scale nuclear exercise in New Brunswick was held in 2006.

7.3.3.1 Plans

Under the provincial *Emergency Measures Act* [34], NB EMO has the lead responsibility for developing provincial emergency plans and coordinating all aspects of an emergency. The *New Brunswick Point Lepreau Nuclear Off-site Emergency Plan*, [35] *Volume 1 Policy* and *Volume II Procedures* are in draft form and meant to be regularly updated.

The plan defines specific responsibilities of the Department of Public Safety and the supporting roles of some 20 organizations. Representatives from these organizations make up the Provincial Emergency Action Committee (PEAC) which directs, controls and coordinates emergency operations, as well as assisting and supporting municipalities as required.

7.3.3.2 Planning zones

The New Brunswick Nuclear Emergency Plan uses a nominal 20 km zone for planning purposes. The approximate population in the zone is 3,000.

Of note, NB Power at Point Lepreau uses three planning zones. NB EMO has indicated that the provincial plans will incorporate these zones shortly. These zones are described as:

- Precautionary protective action zone (4 km)
- Urgent protective action zone (12 km)
- Long-term protective action zone (20 km)

7.3.3.3 Accident/event assessment

Currently, NB EMO does not have a capability to run plume and dose modelling to predict the offsite effects making it difficult to make proactive rather than reactive decisions on protective measures. However, there is a provision for the province to consider pre-emptive, planned evacuation (before the situation deteriorates) in scenarios of fuel damage, potential fuel damage or plant instability. However, this provision depends on the qualitative assessment of NB Power. Following a release, NB EMO would use radiation survey data collected by NB Power to decide on protective measures such as sheltering, evacuation or KI.

7.3.3.4 Public alerting

A telephone-based, auto-dial system is used for alerting the public in the 20 km zone. Members of the public can opt to be texted or have their cell or home phones dialled. The system also notifies all businesses and institutions, such as schools, within the emergency planning zone. A provincial

warden service is also used to provide assistance in the event of a nuclear incident at the NPP, and could be used for door-to-door alerting.

7.3.3.5 Protective measures

The NB plan lists exposure control measures to protect against external irradiation and inhalation of radioactive material. Measures include evacuation, sheltering, thyroid blocking (KI pills). The plan also addresses ingestion control measures, such as protecting the food chain from radioactive material and preventing the ingestion of contaminated food and water.

Under the NB plan, KI pills are pre-distributed to all the residences within the 20 km zone. The pills are also stocked at other locations such as long-term health facilities, hospitals and RCMP posts. The Department of Health and Wellness, in consultation with the PEAC, makes decisions on recommending administration of the KI pills to the public. Notification to the public is carried out by the NB EMO community notification system and followed by wardens, media or public safety announcements and Web bulletins.

7.3.3.6 Summary – New Brunswick

- NB has a basic provincial plan in draft form. An update is in progress and is expected to be published in the fall of 2011.
- Point Lepreau NPP and NB EMO plans are integrated, but there appears to be a disconnect relating to emergency planning zones (4, 12, 20 km).
- NB has no event assessment/modelling capability.
- There is no provincially set requirement for public alerting in New Brunswick.
- An effective automated public alerting system is in place, with backup plans using area wardens.
- The last full-scale nuclear exercise in New Brunswick was held in 2006.

7.4 International stakeholders

7.4.1 Bordering states

U.S. states and Canadian provinces that share borders have mechanisms in place to communicate and work together in the event of any emergency affecting the population on both sides of the border. The states have direct links to liaise and communicate with the provinces. In case of a nuclear emergency, protocols are in place to exchange information between them.

Public Safety Canada (formerly Emergency Preparedness Canada) has signed a memorandum of understanding with the U.S. Federal Emergency Management Agency. Under the umbrella of the *Agreement Between the Government of Canada and the Government of the United States of America on Cooperation in Comprehensive Civil Emergency Planning and Management*, the Canada–United States Joint Radiological Emergency Response Plan was established in 1996. The plan establishes the basis for cooperative measures to effectively deal with a potential or actual peacetime radiological event involving Canada, the United States, or both countries. It is designed to alert the appropriate federal authorities within each country of the existence of a threat from a potential or actual radiological event in order to facilitate cooperation between organizations of the federal government of each country in providing support to states and provinces affected by the radiological event.

7.4.2 International Atomic Energy Agency

Canada is a signatory of the IAEA's *Convention on Early Notification of a Nuclear Accident* (1986), which establishes a notification system for nuclear accidents that have the potential for international trans-boundary release that could be of radiological safety significance for another country. The accident's time, location, radiation releases, and other data essential for assessing the situation must be reported, both directly to the IAEA and to other countries either directly or through the IAEA.

Canada is also a signatory of the IAEA's *Convention on Assistance in the Case of a Nuclear Accident or Radiological Emergency* (1986), which sets out an international framework for cooperation between countries and with the IAEA to facilitate prompt assistance and support in the event of nuclear accidents or radiological emergencies. It requires countries to notify the IAEA of their available experts, equipment, or other materials they could offer in assistance. In case of a request for assistance from an affected country, each country decides whether it can offer the requested assistance. The IAEA, in particular the Incident and Emergency Centre, serves as the focal point for such cooperation by channelling information, supporting efforts, and providing its available services.

Protocols and plans are in place to ensure that the CNSC will be in close communication with the IAEA for any domestic nuclear emergency.

7.4.3 International regulators

During international and domestic nuclear emergencies, the CNSC will need to be in direct or indirect communication with the international regulators.

7.4.3.1 United States Nuclear Regulatory Commission

There is a memorandum of understanding (MoU) between the United States Nuclear Regulatory Commission (U.S. NRC) and the CNSC. As per this MoU, the two sister organizations agree to exchange information. During the Fukushima nuclear emergency, exchange of information between the U.S. NRC and CNSC was very useful.

7.4.3.2 Regulators regulating CANDU reactors

As per the lessons learned from Fukushima Daiichi nuclear emergency, any domestic or international emergency involving CANDU reactors will require the CNSC to communicate with the international regulators regulating the CANDU reactors. Canada chairs the annual CANDU Senior Regulators' Meeting, facilitated by the IAEA and attended by high-ranking regulatory staff in all countries with CANDU reactors. Specific MoUs are in place with most of these regulatory agencies.

7.4.4 Summary – international stakeholders

- The CNSC has MoUs in place with most international stakeholders.
- U.S. states and Canadian provinces have arrangements in place for emergencies.
- The United States and Canada have an arrangement in place specifically for nuclear emergencies.

7.5 Review findings for nuclear emergency management in Canada

The CNSC Task Force has verified that there are no significant gaps in nuclear emergency planning at the provincial and federal levels. Although some opportunities for improvement were identified, overall each province has developed well-documented emergency plans, and these plans and their elements are well integrated in the NPP's onsite emergency plans. At the federal level, Health Canada's FNEP is a mature and comprehensive plan, but it has not been kept up to date. In addition, Public Safety Canada's FERP does not explicitly integrate the FNEP in the overall federal emergency planning and preparedness scheme.

Review findings concerning the CNSC:

1. The *Class I Nuclear Facilities Regulations* do not currently require submission of offsite emergency plans with an NPP operating licence application. Whereas an NPP licensee's onsite emergency plans are submitted to the CNSC as part of the licence application and renewal process, there is no formal requirement for the offsite plans to be submitted to the CNSC.
2. The memoranda of understanding with regulatory counterparts in countries with CANDU reactors have not been reviewed to identify what support, if any, they would require from the CNSC during a nuclear emergency.

Review findings concerning multiple or other jurisdictions:

3. Federal and provincial nuclear emergency planning authorities are not making regularly planned full-scale NPP-focused exercises a priority. It was generally observed at the provincial and federal level that there has been a reduction in the frequency of full-scale NPP-focused exercises. Although all provincial and federal plans reviewed appear to be satisfactory, the implementation, and thus the capability to respond, has generally not been tested in an exercise for several years.
4. Federal and provincial nuclear emergency planning authorities do not fully address recovery phase guidelines and procedures in their emergency plans, as they primarily address only preparedness and response.
5. Federal and provincial nuclear emergency planning authorities have not yet undertaken a formal lessons-learned process to gain knowledge from offsite management of the Fukushima nuclear emergency and update plans accordingly.
6. There is no formal, transparent, national-level oversight process for offsite nuclear emergency plans, programs and performance. Whereas NPP licensees' onsite emergency plans, programs and performance are included in the CNSC regulatory oversight process, there is no similar system of oversight for offsite emergency plans.
7. There is no established national guidance or standard for offsite nuclear emergency planning. Whereas NPP licensees are provided with CNSC guidance on emergency planning, there is no Canadian guidance for offsite nuclear emergency plans.
8. The Health Canada Federal Nuclear Emergency Plan (FNEP) has not been updated since 2002 and is not formally integrated with the Public Safety Canada Federal Emergency Response Plan (FERP). The FNEP and FERP integration has not been validated in a full-scale, NPP-focused exercise.
9. The Province of Ontario planning basis for the current nuclear emergency plans and offsite arrangements is a single-unit accident scenario and does not explicitly consider a multi-unit accident scenario.
10. There are ongoing public alerting issues in the 3 km zone around the Pickering NPP. Also, the new 10 km public alerting requirement has not been fully implemented.
11. The potassium iodide (KI) pills for residents of the planning zone in Ontario are stocked at local pharmacies in the Durham region or the reception centre in Kincardine. The effectiveness of this approach, as opposed to pre-distribution to all households, has not been confirmed.
12. There is no automated public alerting system around the Gentilly-2 NPP.

13. The Province of Quebec has not recently updated its nuclear emergency plan.
14. The Province of New Brunswick does not have the capability for predicting offsite effects.
15. The Province of New Brunswick has not recently updated its nuclear emergency plan.

8 The CNSC Regulatory Framework and Processes

The CNSC Task Force has undertaken a preliminary review of the regulatory framework for existing and potential new build NPPs in Canada. The *Nuclear Power Plant Safety Review Criteria* generally exceed the applicable requirements and expectations of the current CNSC regulatory framework. The CNSC Task Force review findings in this section relate exclusively to the lessons learned from the Fukushima accident.

The CNSC regulatory framework consists of a series of requirements and guidance and is illustrated in figure 8.1. Requirements are set out in legislation, regulations, licences and regulatory documents. Guidance on how applicants and licensees can meet regulatory requirements is provided in guidance documents. Info-documents provide more general information on the regulatory regime and processes for the broader public.

Figure 8.1 Elements of the Regulatory Framework

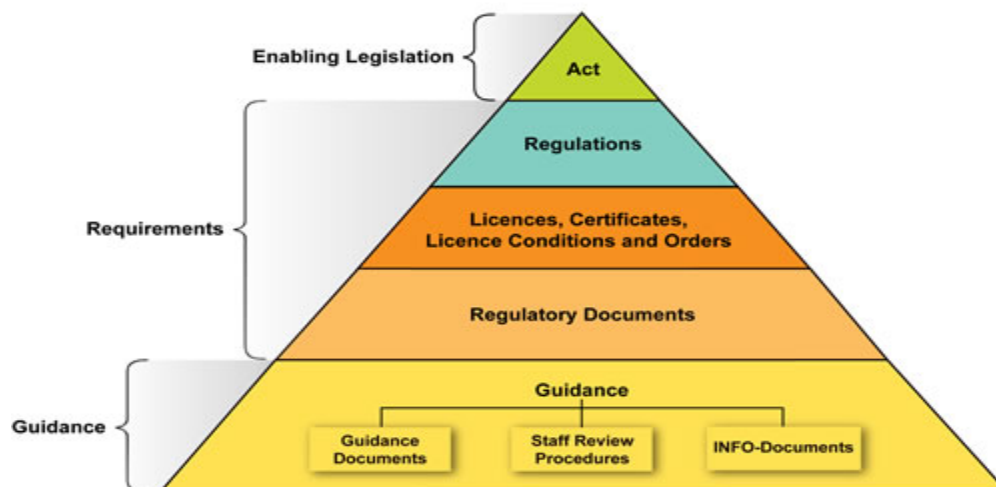

8.1 Act and regulations

The legislation consists of the *Nuclear Safety and Control Act* (NSCA) [36] and its Regulations. These have been reviewed. The NSCA is a robust piece of enabling legislation that sets out the legal framework for regulating the Canadian nuclear industry. All persons wishing to carry out nuclear related activities in Canada are required, by law, to have a licence from the Commission. The Commission is also authorized to make regulations.

Class I nuclear facilities are defined in the *Class I Nuclear Facilities Regulations* [37] and, in addition to NPPs, cover facilities such as small reactors, fuel processing plants and nuclear waste facilities. The CNSC Task Force finds that consideration should be given to modifying the *Class I Nuclear Facilities Regulations* to require submission of offsite emergency plans with an application for a licence to construct or to operate a NPP.

A Commission Member Document (CMD) on *Implementation of Periodic Safety Reviews for Licensing of Nuclear Power Plants* is being prepared. This seeks the Commission's approval to incorporate the periodic safety review (PSR) approach by developing a regulatory document that will be implemented by introducing a licence condition when each power reactor operating licence (PROL) is next renewed. A PSR consists of a systematic and comprehensive comparison against modern standards and technological developments that assures continued plant safety and viability of the licensing basis. In view of the importance of periodically reviewing plant safety against modern standards, the CNSC Task Force finds that consideration should be given to introducing the requirement to perform a PSR in the *Class I Nuclear Facilities Regulations*.

Other regulations made under the NSCA that apply to NPPs include the *General Nuclear Safety and Control Regulations* [9] and the *Radiation Protection Regulations* [38]. No changes to the *General Nuclear Safety and Control Regulations* have been identified as a result of this review. However, the CNSC Task Force finds that section 15 of the *Radiation Protection Regulations* should be reviewed for potential revisions to ensure consistency with international guidance.

Overall, the CNSC Task Force finds that the Act and Regulations are sound. This finding is consistent with a finding by the IAEA International Regulatory Review Service mission to Canada in 2009 [39], that stated "The Canadian legislative and regulatory framework is comprehensive, with an appropriate range of instruments allowing for an effective application of the legal regime."

8.2 Licences, licence conditions and orders

The NSCA authorizes the Commission to establish classes of licences and, therefore, the CNSC has the authority and flexibility to rapidly amend licences to impose additional requirements in order to continuously improve the safety performance of the nuclear industry. This is regarded as a strength of the Canadian system.

The licences that apply to NPPs are power reactor operating licences (PROLs). The CNSC is currently in the process of revising the format of the PROLs to more comprehensively cover the safety and control areas that describe how the NPPs are operated safely. The CNSC is also revising the content of the PROLs to minimize the number of administrative amendments. In parallel with this, each PROL is to be supported by a licence condition handbook (LCH) that describes the compliance verification criteria that will be used to confirm safe operation. Generic templates for both the PROL and NPP LCH have been approved for use.

The CNSC Task Force has reviewed the PROL and NPP LCH templates and finds that some additional requirements and compliance verification criteria should be inserted when the documents are next revised. The licences could be converted to the new format either when they are next renewed, which will take until October 30, 2014, for all licensees. Alternatively, all PROLs could be amended simultaneously when the handbooks are revised and subsequently approved. Given that the industry is already moving to implement the programs needed to meet the new requirements and, given the considerable effort that is required to prepare or revise the LCH for each PROL, the CNSC Task Force finds that the PROLs and LCHs should be amended to the new format when the licences are next renewed.

The CNSC Task Force finds that two new safety requirements should be added to the PROL template. The first is a requirement that the licensees implement and maintain an accident management program. The second is a requirement that the licensees implement and maintain a severe accident management program. The CNSC Task Force also finds that a new licence condition should be added that requires the licensee to implement and maintain a public information program that includes a

proactive disclosure protocol. Similar additions should be made to the NPP LCH template to include compliance verification criteria for the same.

The CNSC Task Force has considered the need for an order to be issued to the industry to implement lessons learned from the Fukushima event. Given that the industry has responded appropriately and voluntarily and is implementing various improvements, the CNSC Task Force finds that no order is required. Instead, CNSC staff will perform regulatory oversight of licensee actions, as per established processes, and verify compliance with the evolving regulatory requirements.

8.3 Regulatory and guidance documents

The CNSC Task Force has reviewed the regulatory and guidance documents published by the CNSC that are referenced in the PROL or LCH.

Specific review findings related to the CNSC regulatory documents by the CNSC Task Force are given in the supporting document on the CNSC regulatory framework [40]. This document should be used by the CNSC Regulatory Framework Steering Committee in prioritizing document reviews and by the document review teams in revising specific regulatory documents.

The overall finding is that there is no overall need for the regulatory framework to be revisited in order to identify the minimum, necessary and sufficient number of regulatory and guidance documents (RDs and GDs) to support the power reactor regulatory program. Should the framework be revisited by the Regulatory Framework Steering Committee in the future, the Task Force finds that the PROL and NPP templates should be used as the basis for identifying needs for RDs or GDs. The PROLs and LCHs currently contain some regulatory requirements or expectations that are not found in RDs or GDs; when the framework is revised, the opportunity should be taken to remedy this.

The CNSC Task Force finds that certain documents should be updated. Examples include RD-337, *Design of New Nuclear Power Plants*; RD-310, *Safety Analysis for Nuclear Power Plants*; S-294, *Probabilistic Safety Assessment (PSA) for Nuclear Power Plants*; G-306, *Severe Accident Management Programs for Nuclear Reactors*; G-225, *Emergency Planning at Class I Nuclear Facilities and Uranium Mines and Mills*; and RD-353, *Testing the Implementation of Emergency Measures*. Other regulatory documents should be updated during their next scheduled revision.

The CNSC Task Force finds that the Commission should approve for publication RD-99.3, *Requirements for Public Information and Disclosure* [41] and GD-99.3, *Guide to the Requirements for Public Information and Disclosure*. GD-99.3 will supersede G-217, *Licensee Public Information Programs* [42], while RD-99.3 will detail the requirements for public information programs and public disclosure as part of that program. The information to be disclosed under these documents includes the impact of natural events such as earthquakes, routine and non-routine releases of radiological and hazardous materials to the environment and unplanned events, including those exceeding regulatory limits. This therefore covers severe accidents such as Fukushima.

In recent years, as some of the older reactors approach the end of their designed life, licensees have applied for life extension for their NPPs. As a prerequisite to the life extension, licensees are required by RD-360, *Life Extension of Nuclear Power Plants* [43] to conduct an integrated safety review³¹ (ISR). As part of the ISR, licensees perform a review of NPPs against modern standards and

³¹ An integrated safety review is effectively a single application of a periodic safety review as described in IAEA safety guide NS-G-2.10, *Periodic Safety Review of Nuclear Power Plants*.

practices. Identified gaps are reviewed and practicable upgrades are incorporated into the integrated improvement plan. Licensees are expected to fill the gaps as far as reasonably practicable.

The ISR provides an opportunity to re-evaluate the entire safety case for an NPP. The CNSC Task Force considers that such reviews should be done on a regular basis by means of periodic safety reviews. A 10-year frequency, in line with international practice, is judged reasonable and could be integrated into the licensing process.

8.4 Other parts of the regulatory framework

This review addresses other requirements or expectations contained in the PROLs and LCHs, principally standards issued by the Canadian Standards Association or requirements or guides issued by the International Atomic Energy Agency. Time has not permitted a review of these other standards, but the CNSC Task Force finds that they should be examined in due course, once the changes needed to the other elements of the regulatory framework have been identified.

8.5 Compliance

A primary activity of CNSC staff is to verify compliance by licensees with regulatory requirements. CNSC staff conduct inspections, reviews, performance assessments and event follow-up to verify compliance. The CNSC Task Force finds that CNSC staff should review the compliance program for needed improvements once the identified changes to the regulatory framework have been implemented. This review will include, but not be limited to, updating the baseline compliance program, under which satisfactory performance of all safety and control areas is verified on a regular basis. In particular, enhanced focus on the following areas is anticipated:

- licensees' accident management programs and provisions, as discussed under section 8.2, including station accident manuals and procedures
- “operational” aspects of nuclear safety, to maintain regulatory overview of the design capabilities to provide fundamental safety functions such as control of fission reaction, cooling of fuel (including in the irradiated fuel bays) and confinement of radioactivity
- holistic evaluation of the overall station safety case against modern standards and best practices

8.6 Processes

In parallel with the review findings aimed at improvements to the various parts of the regulatory framework, the processes for licensing and compliance should also be revisited.

In the broader scope, it may be useful for the environmental assessment process to include consideration of severe accidents, should this be regarded as responsive to public concerns.

8.7 Review findings for the regulatory framework and processes

The CNSC Task Force has performed a review of the CNSC regulatory framework and processes. The review included the *Nuclear Safety and Control Act* and associated Regulations, the CNSC's regulatory documents, power reactor operating licences and their licence condition handbooks, and key regulatory processes. The CNSC Task Force finds that the NSCA does not need revision and there is no need to revisit the structure of the regulatory framework as a result of the lessons learned

from the Fukushima Daiichi accident. The Canadian regulatory framework is strong and comprehensive and is effectively applied even in the case of severe accidents.

Key review findings related to improving the CNSC regulatory framework are:

1. The *Class I Nuclear Facilities Regulations* do not have explicit requirements for submission of offsite emergency plans.
2. The *Radiation Protection Regulations* are not fully consistent with international guidance and do not fully describe the regulatory requirements needed to address radiological hazards during the various phases of an emergency.
3. Canada does not have a formal periodic safety review process. As demonstrated by international practice, regulatory oversight of nuclear power plants may be further enhanced through implementation of a periodic safety review process.
4. Existing licence conditions in power reactor operating licences do not explicitly address accident management, severe accident management and public information.
5. RD-99.3, *Requirements for Public Information and Disclosure*, and its guide, GD-99.3, *Guide to the Requirements for Public Information and Disclosure*, have not been approved for publication, leaving a potential gap in regulatory requirements and guidance for licensees' public information programs.
6. The three-year regulatory framework plan does not currently accommodate the CNSC Task Force review findings.
7. A small number of regulatory documents (RDs) or guidance documents (GDs) are lacking requirements or guidance needed to address the lessons learned.
8. The lessons learned are not yet fully considered for the next revision of other NPP-related RDs or GDs.
9. The lessons learned are not yet fully considered as part of the preparation of new RDs or GDs.
10. Canadian Standards Association standards that apply to NPPs have not been reviewed by the CNSC staff as a result of lessons learned.

The key review finding for the CNSC-managed processes is:

11. Licence condition handbooks are lacking requirements and guidance needed to address lessons learned.

9 Implications for New Builds

Section 8 provides an overall assessment of the CNSC's processes related to the licensing and compliance of nuclear facilities and gives related review findings. This section considers more specific review findings related to the design and analysis of new NPPs and related factors. The lessons learned presented in this section are preliminary and are drawn largely from the assessments performed either by, or on behalf of, the CNSC Task Force for existing reactors (i.e., CANDU technology). In preparation for a formal update to RD-337, *Design of New Nuclear Power Plants*, CNSC staff are undertaking a more comprehensive review of the technology-neutral requirements for new builds. As part of this review, CNSC staff will take into account all lessons learned to date from Fukushima to revise RD-337.

Below, the CNSC Task Force identifies overall review findings. These are followed by specific findings for staff follow-up on particular aspects of design and analysis.

The overall finding is that, to date, there are no lessons learned from Fukushima that challenge the fundamental approach to reactor safety and regulation (i.e., application of the defence-in-depth approach together with multiple physical barriers) for new NPPs in Canada. Nevertheless, it is

important to learn from all events that occur, especially those that have significant consequences for public safety and the environment. The CNSC will change its requirements for new NPPs in response.

The overall review finding is that, while recognizing that the fundamental approach is sound, CNSC staff should reconsider the detailed requirements for the design and analysis of new NPPs in the light of the events of Fukushima to ensure that these are adequate and consistent with best international practices. Staff can undertake this activity during the formal review of RD-337.

The underlying basis and principles by which reactors are designed and regulated is robust – the “extended” defence-in-depth approach together with the application of multiple barriers to the release of radioactivity and radioactive substances is fundamentally sound. The extended approach requires that the design of new NPPs include specific provisions to reduce the probability and mitigate the consequences of severe accidents. This overall approach is applied in international standards such as those of the IAEA, and in Canada is documented in more detail in RD-337, published in 2008. These regulatory requirements for new NPPs represent modern-day practices. Since the publication of RD-337, the CNSC has been participating in international forums and learning from international experience, as well as contributing to the preparation of new standards. Therefore, the CNSC is in the process of updating RD-337 and developing and writing a sister guide, GD-337.

The Fukushima event highlighted the importance of many aspects related to plant design robustness, severe accident phenomena, the management of severe accidents and more generally emergencies, the need for, and adequacy of, complementary design features, and the robustness of the plant to unexpected circumstances including severe external events. Below are specific review findings by the CNSC Task Force for CNSC staff relating to the design and analysis of new NPPs. Many of these findings address issues identified in section 6 for current NPPs. In the former context they point to the need for consideration of improvements or confirmatory assessment. In this context, they point to the need to consider the issues through suitable regulatory requirements for new builds.

1. The safety goals in RD-337, *Design of New Nuclear Power Plants*, are based on single-unit events. Site-based safety goals or other safety criteria that take into account the site characteristics (including population distribution) and the possibility of multiple-unit accidents are not explicitly considered.
2. Although RD-337 already has explicit requirements for the design of complementary design features consistent with international practice, these may not be complete. In addition, there are no explicit requirements for such features for irradiated fuel bays, including combustible gas management.
3. Whereas the safety goals are likely adequate for the design of individual units, these may not be sufficient for a robust demonstration of the offsite response. A separate, more demanding, release value would result in more challenging evaluations of the offsite response.
4. The Fukushima event highlighted the difficulties that can arise when an NPP relies solely on active engineered systems. The need for specific regulatory requirements for passive safety features has not been assessed.
5. The requirements in RD-337 for the design, placement and engineering robustness of irradiated fuel bays is not complete for the entire spectrum of beyond-design-basis scenarios.
6. The CNSC has not documented an overall, systematic approach to the evaluation of all types of external events that could occur in Canada. A systematic approach would encompass both design-basis events and beyond-design-basis events.
7. The Fukushima event highlighted the need for margins to cliff-edges to be understood, particularly when exceeding such cliff-edges may have catastrophic consequences. CNSC currently has no explicit requirements for the assessment of such margins for new nuclear power plants.

8. The CNSC has no requirements for the analysis of multi-unit accidents, particularly those that could arise from common-cause events.
9. The CNSC requirements for the design that would facilitate accident management and severe accident management are incomplete. For example, there are no explicit provisions for the use of portable equipment and the availability of connections for temporary supplies of electrical power and water.
10. The CNSC does not have explicit requirements for complementary design features that could be called upon to protect the containment. One such feature is filtered containment venting.
11. The CNSC does not have comprehensive requirements for minimum times before significant operator interventions are required. Such requirements would be commensurate with the type of intervention, for example, the need for offsite portable equipment to be brought onsite.
12. Previous accidents have identified the importance of operators having access to reliable plant information. The CNSC currently does not have explicit requirements for “hardened” plant monitoring features and instrumentation that would function reliably under severe accident conditions, and for the control room equipment expected to be available.
13. The CNSC does not have design requirements for automated real-time onsite field radiation monitoring.
14. The CNSC does not have explicit requirements for the emergency heat removal system for beyond-design-basis conditions, including the mission time during which it must be available.
15. The CNSC does not have a full set of requirements for plant and site layout that would facilitate protection against external hazards.
16. CNSC requirements for operational limits and conditions do not integrate into one structure the command and control needs during normal operation, the emergency operating procedures and severe accident management guidelines. Furthermore, there is currently no requirement for further guidance similar to the “extensive damage mitigation guidelines” used in the United States, which can be used when extensive damage has occurred across a site.

10 Conclusions and Recommendations

The CNSC Task Force confirms that the CANDU units are robust and have a strong design relying on multiple layers of defence. The design ensures that there will be no impact on the public from external events that have been regarded as credible during the lifetime of the station. The design also offers protection against external events that have a very low probability of occurring. However, the design basis for certain external events at certain stations may now need to be updated.

The post-Fukushima review has examined events more severe than those that have historically been regarded as credible and their impact on the NPPs. The CNSC Task Force has proposed changes to design or procedures wherever gaps were found in order to minimize or eliminate their impact.

The actions taken by the industry and proposed for the future will ensure that the impact on the public is as low as reasonably practicable for extreme events, so as not to add to the consequences to society beyond those caused directly by the events themselves.

The CNSC Task Force has made a number of detailed review findings that relate exclusively to the lessons learned from the Fukushima accident; all of these findings are listed in sections 6 to 9 of the report. The review findings have been determined through comparison with the *Nuclear Power Plant Safety Review Criteria*. These criteria generally exceed the applicable requirements and expectations of the current CNSC regulatory framework.

Overall, the CNSC Task Force concludes that Canadian NPPs are safe and pose a very small risk to the health and safety of Canadians or to the environment. The CNSC Task Force is confident that the

recommendations in this report will further enhance the safety of nuclear power in Canada and will reduce the associated risk to as low as reasonably practicable.

Under the oversight of the CNSC and its staff, Canadian nuclear power plants have been running safely for over 40 years. As has always been the case, they will only be licensed if the CNSC is satisfied that they will continue to be operated safely.

The CNSC Task Force recommendations below apply to currently operating reactors and must be considered for new builds. The recommendations below are based on the findings given in sections 6 to 9 of the report. Appendix D summarizes how the findings correspond to the recommendations.

10.1 Strengthening reactor defence in depth

1. Licensees should systematically verify the effectiveness of, and supplement where appropriate, the existing plant design capabilities in beyond-design-basis accident conditions, including:
 - a) overpressure response of the main systems and components
 - b) containment performance to prevent unfiltered releases of radioactive products
 - c) control capabilities for hydrogen and other combustible gases:
 - i accelerate installation of the hydrogen management capability and sampling provisions
 - ii include spent fuel bays and any other areas where hydrogen accumulation cannot be precluded
 - d) make-up capabilities for the steam generators, primary heat transport system and connected systems, moderator, shield tank, and spent fuel bays
 - e) design requirements for the self-sufficiency of a plant site such as availability and survivability of equipment and instrumentation following a sustained loss of power and capacity to remove heat from a reactor
 - f) control facilities³² for personnel involved in management of the accident
 - g) emergency mitigating equipment and resources that could be stored offsite and brought onsite if needed

2. Licensees should conduct more comprehensive assessments of site-specific external hazards to demonstrate that:
 - a) considerations of magnitudes of design-basis and beyond-design-basis external hazards are consistent with current best international practices
 - b) consequences of events triggered by external hazards are within applicable limits

Such assessments should be updated periodically to reflect gained knowledge and modern requirements.

3. Licensees should enhance their modelling capabilities and conduct systematic analyses of beyond-design-basis accidents to include analyses of:
 - a) multi-unit events
 - b) accidents triggered by extreme external events
 - c) spent fuel bay accidents

The analyses should include estimation of releases, into the atmosphere and water, of fission products, aerosols and combustible gases.

³² Control facilities are the locations where control of the reactor and accident mitigation measures can be undertaken; for example, main control room, secondary control areas and emergency centres.

10.2 Enhancing emergency response

4. Licensees should assess emergency plans to ensure emergency response organizations will be capable of responding effectively in a severe event and/or multi-unit accident, and conduct sufficiently challenging emergency exercises based on them.
5. Licensees should review and update their emergency facilities and equipment, in particular:
 - a) ensure operability of primary and backup emergency facilities and of all emergency response equipment that require electrical power and water
 - b) formalize all arrangements and agreements for external support and document these in the applicable emergency plans and procedures
 - c) verify or develop tools to provide offsite authorities with an estimate of the amount of radioactive material that may be released and the dose consequences, including the installation of automated real-time station boundary radiation monitoring systems with appropriate backup power
6. Federal and provincial nuclear emergency planning authorities should undertake a review of their plans and supporting programs, such as:
 - a) ensuring plan revision activities are expedited and making regular full-scale exercises a priority
 - b) establishing a formal, transparent, national-level oversight process for offsite nuclear emergency plans, programs and performance
 - c) reviewing the planning basis of offsite arrangements in view of multi-unit accident scenarios
 - d) reviewing arrangements for protective action including resolving the issues pertaining to public alerting, validating the effectiveness of potassium iodide (KI) pill-stocking and distribution strategies and verifying, or developing the capability for predicting, offsite effects

10.3 Improving regulatory framework and processes

7. The CNSC should initiate a formal process to amend the *Class I Nuclear Facilities Regulations* to require NPP licensees to submit offsite emergency plans with an application to construct or operate a nuclear power plant.
8. The CNSC should amend the *Radiation Protection Regulations* to be more consistent with the current international guidance and to describe in greater detail the regulatory requirements needed to address radiological hazards during the various phases of an emergency.
9. The CNSC should update the regulatory document framework through:
 - a) updating selected design-basis and beyond-design-basis requirements and expectations, including those for:
 - i external hazards and the associated methodologies for assessment of magnitudes
 - ii probabilistic safety goals
 - iii complementary design features for both severe accident prevention and mitigation
 - iv passive safety features
 - v fuel transfer and storage
 - vi design features that would facilitate accident management
 - b) developing a dedicated regulatory document on accident management
 - c) strengthening the suite of emergency preparedness regulatory documents
 - d) reviewing applicable Canadian Standards Association standards

10. The CNSC should amend all power reactor operating licences to include specific licence conditions, requiring implementation of accident management provisions, severe accident management and public information.
11. The CNSC should further enhance the regulatory oversight of nuclear power plants through implementation of a periodic safety review process.
12. The CNSC should review memoranda of understanding with regulatory counterparts in countries with CANDU reactors to outline what support, if any, they would require from the CNSC during a nuclear emergency.
13. The CNSC should enhance cooperation with other nuclear regulators in addressing the lessons learned from the Fukushima accident and thus further strengthen the capability to respond efficiently to any nuclear emergency.

Glossary

accident

Any unintended event (including operating errors, equipment failures or other mishaps), the consequences or potential consequences of which are not negligible from the point of view of protection or safety.

For the purposes of this document, accidents include design-basis accidents and beyond-design-basis accidents. Accidents exclude anticipated operational occurrences, which have negligible consequences from the perspective of protection or safety.

anticipated operational occurrence

An operational process deviating from normal operation which is expected to occur at least once during the operating lifetime of a reactor facility but which, in view of the appropriate design provisions, does not cause any significant damage to items important to safety or lead to accident conditions.

beyond-design-basis accident

Accident conditions less frequent and more severe than a design-basis accident. A beyond-design-basis accident may or may not involve core degradation.

Class I nuclear facility

A Class I nuclear facility refers to a Class IA and a Class IB nuclear facility as described in the *Class I Nuclear Facilities Regulations*.

common-cause event

An event that leads to common-cause failures.

common-cause failure

A concurrent failure of two or more structures, systems or components due to a single specific event or cause such as natural phenomena (such as earthquakes, tornadoes or floods), design deficiency, manufacturing flaws, operation and maintenance errors, human-induced destructive events and others.

complementary design feature

A design feature from the design-basis envelope that can be used to cope with beyond-design-basis accidents, including severe accidents.

conservatism

Use of assumptions, based on experience or indirect information, about a phenomenon or behaviour of a system being at or near the limit of expectation, which increases safety margins or makes predictions regarding consequences more severe than if best-estimate assumptions had been made.

containment

A method or physical structure designed to prevent the release of radioactive substances. This term is typically used in power reactors.

core damage

Core degradation resulting from event sequences more severe than design-basis accidents.

core damage frequency

An expression of the likelihood that, given the way a reactor is designed and operated, an accident could cause the fuel in the reactor to be damaged.

crediting

Assuming the correct operation of a structure, system or component or correct operator action, as part of an analysis.

defence in depth

A hierarchical deployment of different levels of diverse equipment and procedures to prevent the escalation of anticipated operational occurrences and to maintain the effectiveness of physical barriers placed between a radiation source or radioactive material and workers, members of the public or the environment, in operational states and, for some barriers, in accident conditions.

design basis

The range of conditions and events taken into account in the design of structures, systems and components of a nuclear facility, according to established criteria, such that the facility can withstand them without exceeding authorized limits by the planned operation of safety systems.

design-basis accident

Accident conditions for which a reactor facility is designed according to established design criteria, and for which damage to the fuel and the release of radioactive material are kept within regulated limits.

deterministic safety analysis

An analysis of reactor facility responses to an event performed using predetermined rules and assumptions (e.g., those concerning the initial facility operational state, availability and performance of the facility systems and operator actions). Deterministic safety analysis can use either conservative or best-estimate methods.

diversity

The presence of two or more redundant systems or components to perform an identified function, where the different systems or components have different attributes so as to reduce the possibility of common-cause failure.

emergency exercise

Simulation of emergency events in order to test the integrated performance of an emergency response scenario.

emergency drill

Testing of a procedure or other specific aspect of an emergency response.

emergency response

The integrated set of infrastructural elements necessary to provide the capability for performing a specified function or task required in order to prevent, mitigate or control the effects of an accidental release.

emergency response organization

Group of inter-related responders whose function is to mitigate the consequences of an emergency. An emergency response organization involves predefined coordination of roles and responsibilities.

external event

Any event that proceeds from the environment external to a reactor facility and that can cause failure of structures, systems and/or components. External events include, but are not limited to, earthquakes, floods and hurricanes.

external hazard

An event of natural or human-induced origin that originates outside the site and whose effects on the reactor facility should be considered as potentially hazardous.

fail-safe design

Design whose most probable failure modes do not result in a reduction of safety.

heat sink

A system or component that provides a path for heat transfer from a source, such as heat generated in the fuel, to a large heat-absorbing medium, such as water.

independent system

A system whose ability to perform its required function is unaffected by the operation or failure of another system.

internal event

An event internal to the reactor facility that results from human error or failure in a structure, system or component.

malevolent act

An illegal action or an action that is committed with the intent of causing wrongful harm.

mission time

The duration within which a system or component is required to operate or be available to operate and fulfill its function following an event.

mitigation

Measures aimed at limiting the scale of core damage, preventing interaction of the molten material with containment structures, maintaining containment integrity, and minimizing offsite releases, in the event of an accident.

normal operation

Operation of a reactor facility within specified operational limits and conditions including startup, power operation, shutdown, maintenance, testing and refuelling.

postulated initiating event

An event identified in the design (e.g., of a reactor) as leading to either an anticipated operational occurrence or accident conditions. This means that a postulated initiating event is not necessarily an accident itself; rather it is the event that initiates a sequence that may lead to an anticipated operational occurrence, a design-basis accident, or a beyond-design-basis accident, depending on the additional failures that occur.

practicable

Technically feasible and justifiable while taking cost-benefit considerations into account.

pressure boundary

A boundary of any pressure-retaining vessel, system or component of a nuclear or non-nuclear system.

prevention

In the context of severe accident management, measures aimed at averting or delaying the onset of a severe accident.

probabilistic safety assessment (PSA)

A comprehensive and integrated assessment of the safety of a reactor facility. The safety assessment considers the probability, progression and consequences of equipment failures or transient conditions to derive numerical estimates that provide a consistent measure of the safety of the reactor facility, as follows:

- A Level 1 PSA identifies and quantifies the sequences of events that may lead to the loss of core structural integrity and massive fuel failures.
- A Level 2 PSA starts from the Level 1 results and analyzes the containment behaviour, evaluates the radionuclides released from the failed fuel and quantifies the releases to the environment.
- A Level 3 PSA starts from the Level 2 results, analyzes the distribution of radionuclides in the environment, and evaluates the resulting effect on public health.

process system

A system whose primary function is to support (or contribute to) the production of steam or electricity.

safety analysis

Analysis by means of appropriate analytical tools that establishes and confirms the design basis for the items important to safety, and ensures that the overall reactor facility design is capable of meeting the acceptance criteria for each reactor state.

safety case

An integrated collection of arguments and evidence to demonstrate the safety of a facility. A safety case will normally include a safety assessment, but could also typically include information (including supporting evidence and reasoning) on the robustness and reliability of the safety assessment and the assumptions made therein.

safety function

A specific purpose that must be accomplished for safety.

safety margin

A margin to a value of safety variable for a barrier or a system at which damage or loss would occur. Safety margins are considered for those systems and barriers whose failure could potentially contribute to radiological releases.

safety system

A system provided to ensure the safe shutdown of a reactor or the residual heat removal from the core, or to limit the consequences of anticipated operational occurrences and design-basis accidents.

severe accident

A beyond-design-basis accident that involves significant core degradation.

severe accident management (SAM) program

A program that establishes both of the following:

1. the actions to be taken to prevent severe damage to the reactor core, to mitigate the consequences of the core damage should it occur, and to achieve a safe, stable state of the reactor over the long term
2. the preparatory measures necessary for implementation of such actions

shutdown state

A subcritical reactor state with a defined margin to prevent a return to criticality without external actions.

structures, systems and components

A general term encompassing all of the elements, except human factors, of a facility or activity that contribute to protection and safety.

Structures are the passive elements, such as buildings, vessels and shielding. A system comprises several components, assembled in such a way as to perform a specific (active) function. Components are the discrete elements of a system, such as wires, transistors, integrated circuits, motors, relays, solenoids, pipes, fittings, pumps, tanks and valves.

References

- 1 [Report of the Japanese Government to the IAEA Ministerial Conference on Nuclear Safety – Accident at TEPCO’s Fukushima Nuclear Power Stations](#), Government of Japan, 2011-06-18
- 2 [Roadmap towards Restoration from the Accident at Fukushima Daiichi Nuclear Power Station - Update](#), Tokyo Electric Power Company, 2011-09-20
- 3 [Sources and Effects of Ionizing Radiation](#), Volume 1, UNSCEAR, 2008
- 4 DRPH-2011-010, [Assessment on the 66th Day of Projected External Doses for Populations Living in the North-West Fallout Zone of the Fukushima Nuclear Accident](#), IRSN, 2011-05-23
- 5 [Canadian Guidelines for Intervention During a Nuclear Emergency](#), Health Canada, 2002-11
- 6 ICRP Publication 103, [The 2007 Recommendations of the International Commission on Radiological Protection](#), Ann. ICRP 37 (2-4), 2007
- 7 ICRP Publication 109, [Application of the Commission’s Recommendations for the Protection of People in Emergency Exposure Situations](#), Ann. ICRP 39 (1), 2009
- 8 [CNSC Emergency Response Plan CAN – 2.1](#), Revision 6, CNSC, 2010-12
- 9 [General Nuclear Safety and Control Regulations](#), S.O.R./2000-202
- 10 CMD 11-M15, [CNSC Staff Presentation on Fukushima Event](#), CNSC, 2011-03-30
- 11 CMD 11-M30, [Status Report on Power Reactors / Rapport d’étape sur les centrales nucléaires](#), CNSC, 2011-06-02
- 12 [Terms of Reference, CNSC Task Force on Review of Japan Nuclear Event: Implications on Canadian Nuclear Power Plants](#), CNSC, 2011-04-14
- 13 [CNSC Fukushima Task Force: Nuclear Power Plant Safety Review Criteria](#), CNSC, 2011-07-07
- 14 [Charter for the Nuclear Regulatory Commission Task Force to Conduct a Near-term Evaluation of the Need for Agency Actions Following the Events in Japan](#), US-NRC, ML110910479, 2011-04-01
- 15 [“Stress Tests” Specifications: Proposal by the WENRA Task Force](#), WENRA, 2011-04-12
- 16 [Declaration of ENSREG, EU “Stress Test” Specifications](#), 2011-05-13
- 17 El-Sabh, M.I., Murty, T.S., and Dumais, J.-F., 1988, *Tsunami Hazards in the St. Lawrence Estuary, Canada*, in: El-Sabh, M.I., and Murty, T.S. (eds.), *Natural and Man-Made Hazards*, D. Reidel Publishing, Dordrecht, the Netherlands, p. 201-213
- 18 S-294, [Probabilistic Safety Assessment \(PSA\) for Nuclear Power Plants](#), CNSC, 2005-04
- 19 [Reactor Siting and Design Guide](#), AECB, 1964-11
- 20 C6 Rev 0, [Requirements for the Safety Analysis of CANDU Nuclear Power Plants](#), AECB, 1980-06
- 21 RD-310, [Safety Analysis for Nuclear Power Plants](#), CNSC, 2008-11
- 22 RD-337, [Design of New Nuclear Power Plants](#), CNSC, 2008-11
- 23 G-306, [Severe Accident Management Programs for Nuclear Reactors](#), CNSC, 2006-05

- 24 GS-G-2.1, [*Arrangements for Preparedness for a Nuclear or Radiological Emergency*](#), IAEA, 2007-03-23
- 25 RD-353, [*Testing the Implementation of Emergency Measures*](#), CNSC, 2008-10
- 26 G-225, [*Emergency Planning at Class I Nuclear Facilities and Uranium Mines and Mills*](#), CNSC, 2001-08
- 27 [*Federal Nuclear Emergency Plan Part 1: Master Plan*](#), Health Canada, 2002
- 28 [*Emergency Management Act*](#), (S.C. 2007, c. 15), Public Safety Canada, 2007
- 29 [*Federal Emergency Response Plan*](#), Public Safety Canada, 2011
- 30 [*Emergency Management and Civil Protection Act*](#), R.S.O. 1990, Ontario, 1990
- 31 [*Provincial Nuclear Emergency Response Plan*](#), Ontario, 2009
- 32 [*Plan national de sécurité civile*](#), Sécurité publique Québec, 2010
- 33 [*Loi sur la sécurité civile*](#), LRQ, c. S-2.3, Sécurité publique Québec, 2011
- 34 [*Emergency Measures Act*](#), c. E-7.1, New Brunswick Department of Public Safety, 1978
- 35 *Point Lepreau Nuclear Generating Station Off-site Emergency Plan*, New Brunswick. Emergency Measures Organization, 1982
- 36 [*Nuclear Safety and Control Act*](#), S.C. 1997, c. 9
- 37 [*Class I Nuclear Facilities Regulations*](#), S.O.R./2000-204
- 38 [*Radiation Protection Regulations*](#), S.O.R./2000-203
- 39 [*International Regulatory Review Service \(IRRS\) Report to the Government of Canada*](#), Ottawa, Canada, 31 May to 12 June 2009
- 40 *CNSC Fukushima Task Force Review Report – Focus Area: Regulatory Framework*, CNSC, 2011-08-19
- 41 RD-99.3, [*Requirements for Public Information and Disclosure*](#), CNSC, 2010-11
- 42 GD-99.3, [*Guide to the Requirements for Public Information and Disclosure*](#), CNSC, 2010-11
- 43 RD-360, [*Life Extension of Nuclear Power Plants*](#), CNSC, 2008-02

Appendix A CANDU Overview

All Fukushima Daiichi reactor units are boiling-water reactors (BWRs) designed by General Electric about 40 years ago. A BWR is a light-water reactor (LWR) in which light water³³ serves both as the reactor coolant and the moderator³⁴. The fuel is arranged in long vertical assemblies located inside the reactor pressure vessel.

All currently operating Canadian nuclear power plant (NPP) reactor units are CANDU (Canadian Deuterium-Uranium) reactors. The CANDU reactor is a heavy-water moderated, natural uranium fuelled reactor with pressure tubes. The core consists of an array of horizontal pressure tubes located inside a large, horizontally mounted cylindrical vessel, the calandria. The pressure tubes contain the fuel (figure A.1) and coolant. The calandria contains the heavy-water moderator, besides the pressure tubes.

Figure A.1 Arrangement of Fuel Bundles in a CANDU Calandria

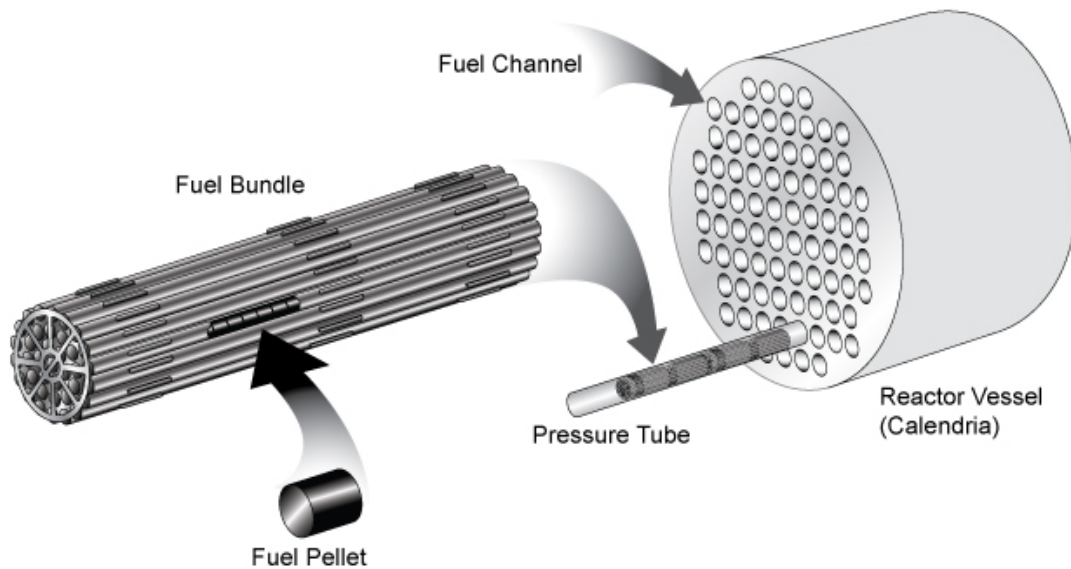

Pressurized heavy water coolant is pumped through the pressure tubes, cooling the fuel and carrying heat from the fuel to the outlet header and to the steam generators (figure A.2).

Each pressure tube is isolated and insulated from the heavy water moderator by a concentric calandria tube (figure A.3).

³³ Light water is normal water composed of one oxygen and two hydrogen atoms (H₂O). In heavy water, the hydrogen atoms are replaced by deuterium atoms (D₂O). Deuterium is a heavy isotope of hydrogen with one proton and one neutron in the nucleus, compared to normal hydrogen which has only a single proton.

³⁴ The moderator in a nuclear reactor is the material used to slow down neutrons emitted in the fission process.

Figure A.2 Simplified Schematic and Location of Major Systems

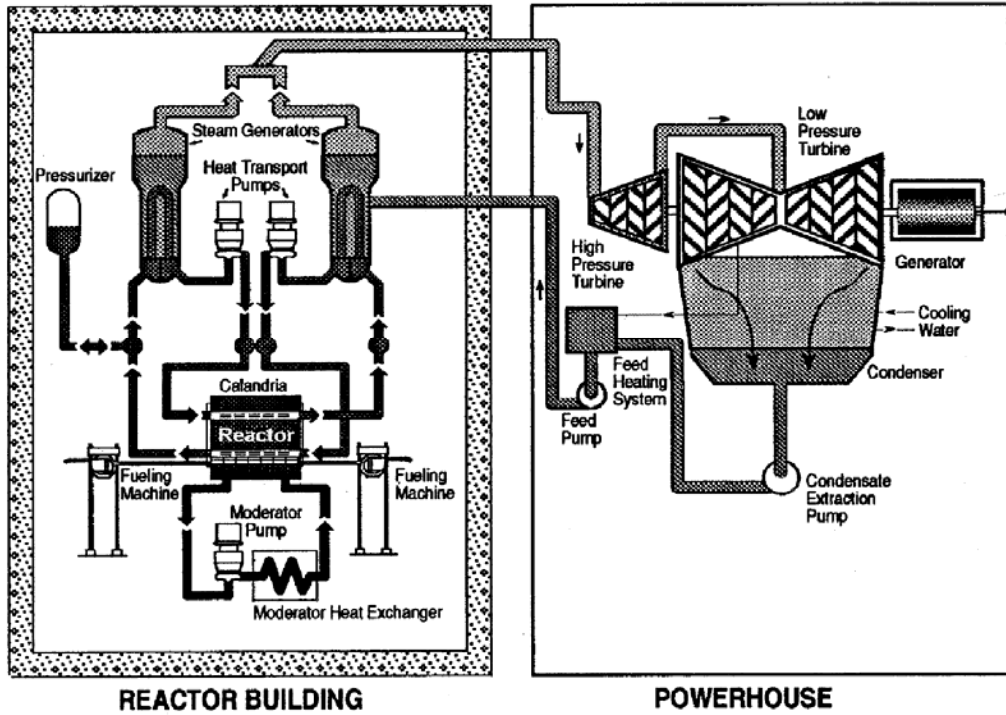
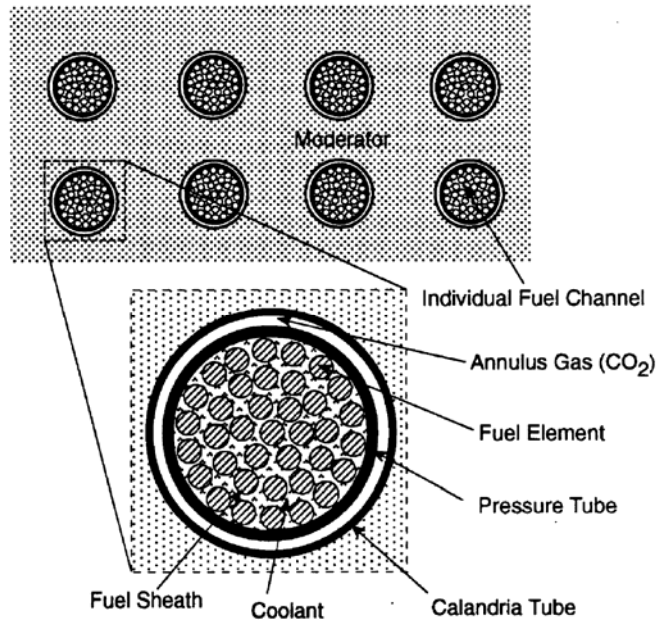

Figure A.3 Arrangement of Fuel Elements, Pressure and Calandria Tubes



The annular space between the pressure and calandria tubes is filled with carbon dioxide gas. In CANDU reactors, the moderator system is separated from the high-temperature, high-pressure

coolant in the pressure tubes. Therefore, the CANDU reactors are based on a pressure-tube design, not on a pressure-vessel design. The pressurized portion of the reactor is limited to the fuel channels, which are of relatively small diameter, while the calandria (figure A.4) operates at nearly atmospheric pressure. Pressure tube leaks can be readily detected by monitoring the moisture content and pressure in the annular, gas-filled space between the pressure tube and calandria tube.

Figure A.4 Calandria Assembly

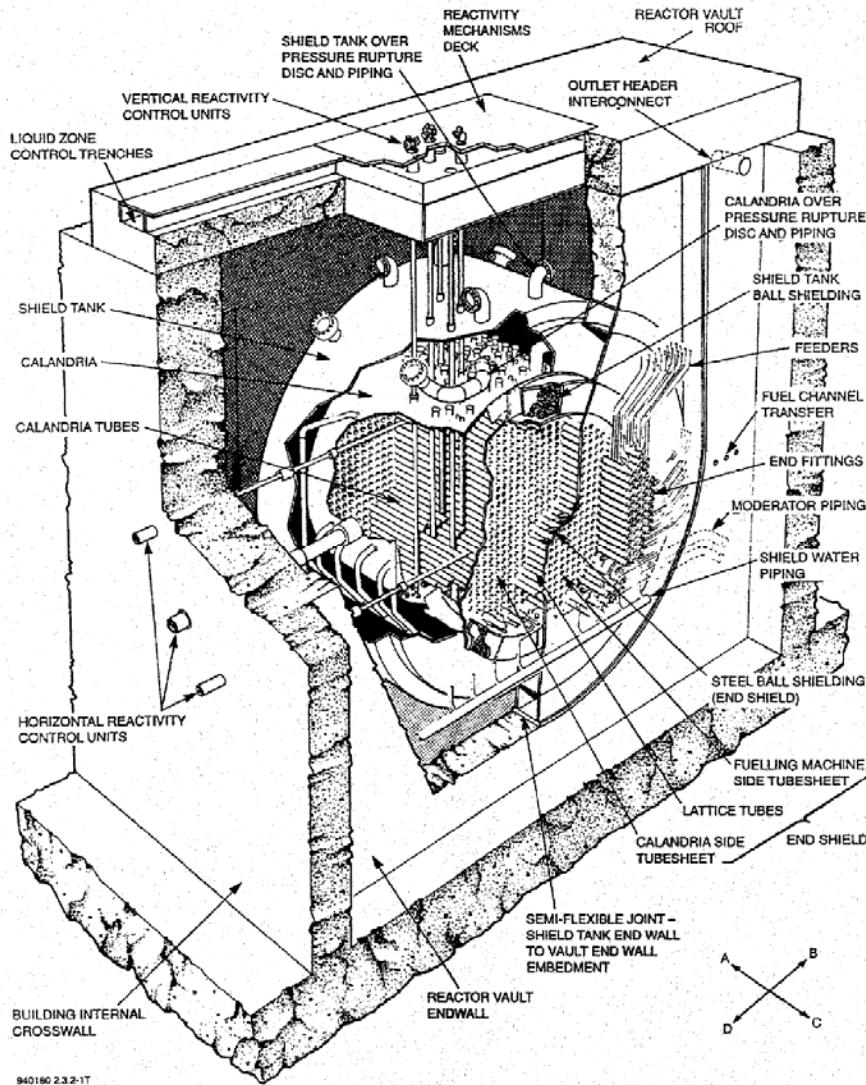

Due to this physical separation from the coolant, the moderator operates at low temperature (60°–70°C) and low (atmospheric) pressure. This allows the moderator to act as an emergency heat sink capable of removing decay heat even if normal and emergency cooling fail. Also, since the moderator is cool, it cannot add any significant amount of energy to the containment system under accident conditions, such as might occur if a pressure tube ruptured. In CANDU designs, the calandria is surrounded either by a light-water-filled steel shield tank (used for biological and thermal shielding) or by a steel-lined concrete vault called a “calandria” vault. In all stations with calandria vaults, except Pickering A, the vault is filled with light water and can also act as an additional heat sink in

severe accident scenarios. Figure A.5 shows the approximate inventory³⁵ of heavy and light water in the CANDU 6 reactor, which surrounds the fuel and calandria vessel.

Figure A.5 Schematic of a CANDU 6 Reactor Core

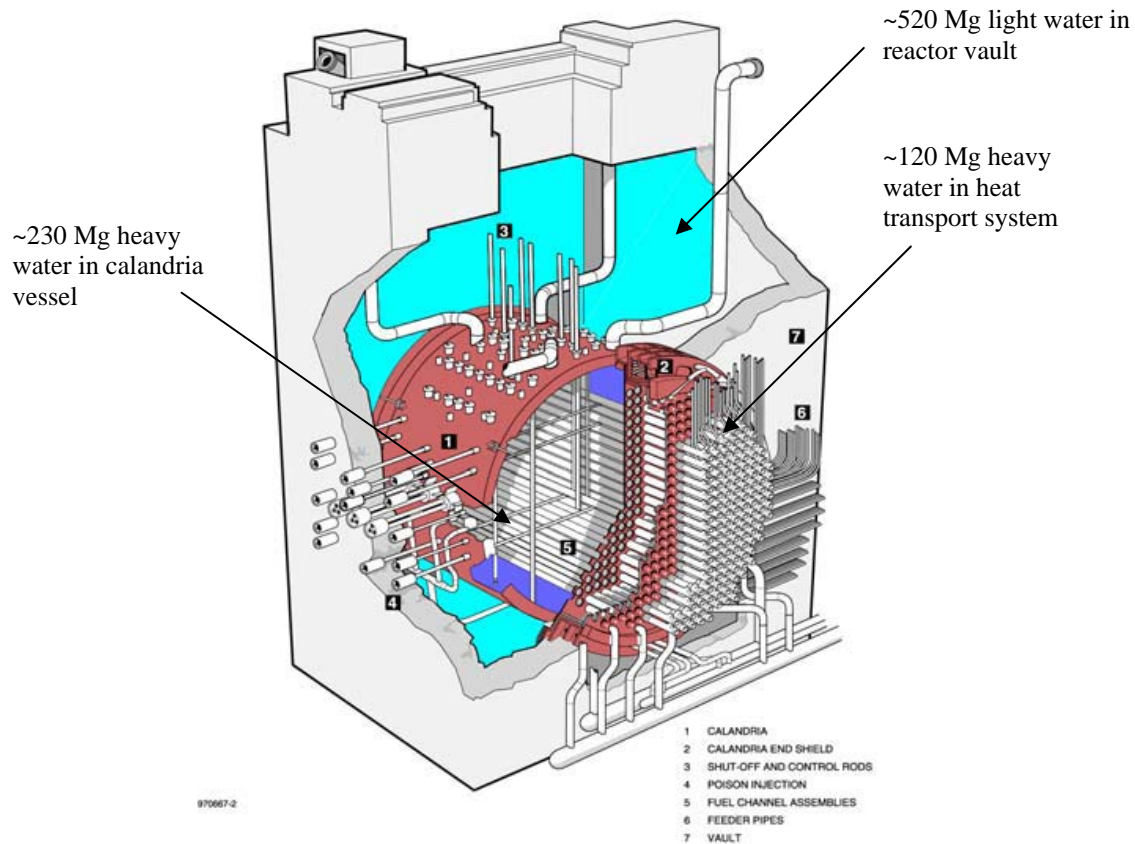

In CANDU designs, the moderator provides a low-pressure environment for the reactivity control devices (such as control rods) located or introduced into guide tubes positioned interstitially between rows of calandria tubes. In addition, the location of neutronics measurement devices in the moderator avoids subjecting this equipment to a hot, pressurized environment.

CANDU reactors incorporate two³⁶ diverse, fail-safe and passive shutdown systems (Shutdown System No. 1 and Shutdown System No. 2) which are independent of each other and from the reactor regulating system. The first shutdown system consists of shutoff rods which are vertically oriented above the reactor core and are gravity-driven with spring assistance.

The second shutdown system uses high-pressure liquid poison³⁷ injected into the moderator. Injection is accomplished by opening fast-acting valves between a high-pressure helium tank and the poison tanks. When the valves open, the liquid poison is injected into the reactor moderator through

³⁵ The inventory is given in megagrams (Mg). 1 Mg = 1 tonne or metric ton.

³⁶ Pickering A Shutdown System 2 is not based on the liquid poison injection, but on the moderator dump system. Since Pickering A has a moderator dump system, a spray cooling system is provided to cool the calandria tubes.

³⁷ Liquid poison (usually boron or gadolinium) is a strong absorber of neutrons and quickly stops (or “poisons”) the nuclear reaction.

horizontally oriented nozzles that span the core. The nozzles are designed to inject the poison in four different directions in the form of a large number of individual jets. This disperses the poison rapidly throughout a large fraction of the core. Neither Shutdown System No. 1 nor Shutdown System No. 2 requires an electrical trigger. Both shutdown systems are fail-safe – they operate automatically if the electricity is turned off – with the poison being injected by compressed helium and, with the rods, hung above the core with electromagnets, being drawn down by gravity.

Because of the use of natural uranium as fuel, any significant alteration of the CANDU reactor's original fuel channel geometry (e.g., increase or decrease of spacing in the CANDU core's lattice pitch arrangement) decreases the probability of sustaining a chain reaction. In addition, criticality³⁸ of CANDU fuel bundles in light water is impossible. Since most of the water inside containment is light water, criticality is not a concern in severe accidents.

In CANDU reactors, a large number of horizontal pressure-tube fuel channels are connected by individual feeder pipes to horizontal headers. The headers are connected to pumps and steam generators. The headers and steam generators are located above the core. The positioning of the steam generators above the core promotes natural circulation flow called thermosyphoning (i.e., movement due to the coolant's own density differences), which can remove decay heat if shutdown cooling is lost. Thermosyphoning is illustrated in figure A.6. When electrical power is lost to a heat transport pump motor, the pump continues to spin down under inertia, assisted by a large flywheel integral to the pump. This ensures that flow drops more slowly than power (falling rapidly due to reactor trip) so that fuel is adequately cooled. It also establishes forward flow through the fuel channels initially. As the coolant (heavy water) passes over the fuel in the fuel channels, it is heated and decreases in density. It flows out of the channel and up to the boilers. In the boilers, heat is transferred to the secondary side so the coolant gets cooled and its density increases. It flows back to the fuel channels and “pushes” out the less dense hotter water in the channel. Thus, as with other designs, the CANDU reactors have the capability of passively removing decay heat provided that water can be injected to the boilers and that there is no significant leakage of primary coolant.

³⁸ A reactor is “critical” when the fission chain reaction is self-sustaining. The number of neutrons created in the core is balanced by the number lost when reactor materials absorb them or when they pass outside the core. When the reactor is “subcritical”, the fission chain reaction quickly drops to a very low value.

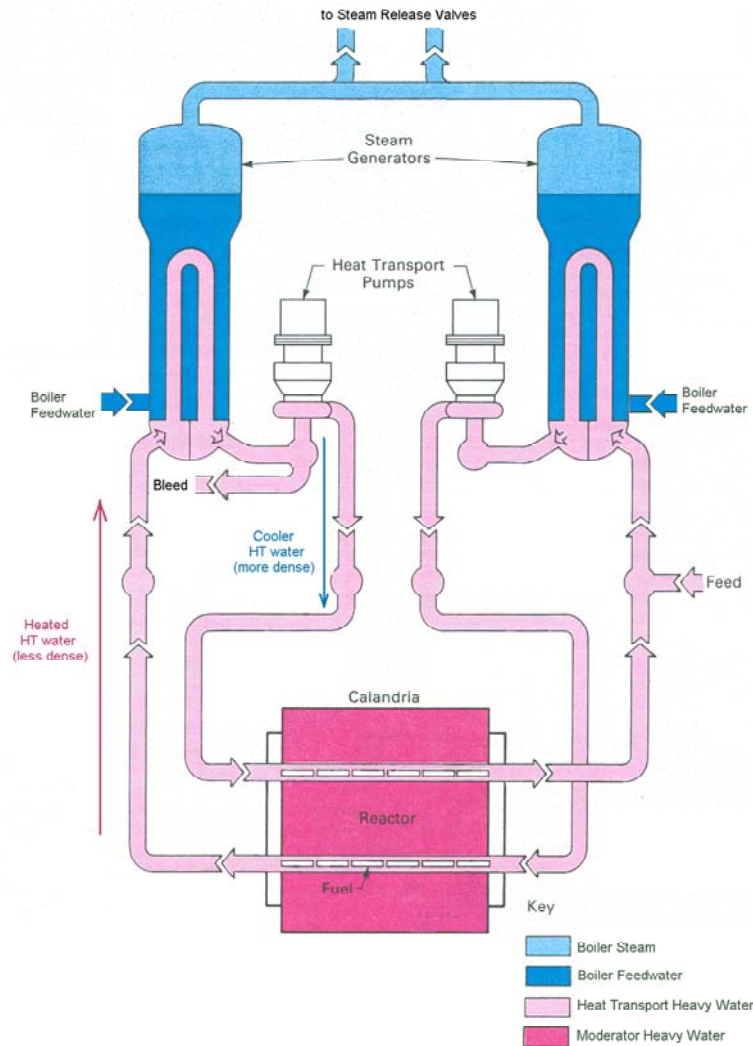
Figure A.6 Simplified Schematic of Thermosyphoning

A complete station blackout occurred in a pressurized heavy-water reactor similar to a CANDU (Douglas Point design) in March 1993 at the Narora Atomic Power Station in India. Decay heat removal during the blackout was mainly due to the flow coastdown followed by thermosyphoning. During the accident, caused by a fire in the Turbine Building, the emergency crew was able to manually open the valves allowing injection of fire water to the steam generators. Five hours into the accident, when entry in the primary containment was deemed safe, fire water was connected to the shield cooling system. The reactor was maintained in a safe shutdown condition, with adequate subcriticality for 17 hours, until the shared emergency diesel generator was restarted and normal shutdown cooling was started.

Similarly, during the August 14, 2003, blackout of southern Ontario and the northeastern United States, the fuel in the Pickering B reactors was cooled by thermosyphoning for up to nine hours. According to Ontario Power Generation's (OPG) estimates, thermosyphoning would have continued to be an effective heat sink for many more hours if restoration of offsite power had been delayed.

In most CANDU designs, the subdivision of the reactor core into two loops, each supplying coolant to half the core, provides that in a loss-of-coolant accident (LOCA), the break affects half the core. In addition, there are two core-passes per loop (as shown in figure A.7), which means that only a quarter of the core would likely suffer a major mismatch between heat generation and removal under the LOCA conditions. CANDU reactors have emergency core cooling systems to provide core cooling in the event of a LOCA in one unit. The systems are designed to prevent severe core damage for all break sizes up to the diameter of the largest pipe in the heat transport system.

Figure A.7 Heat Transport System, CANDU 6

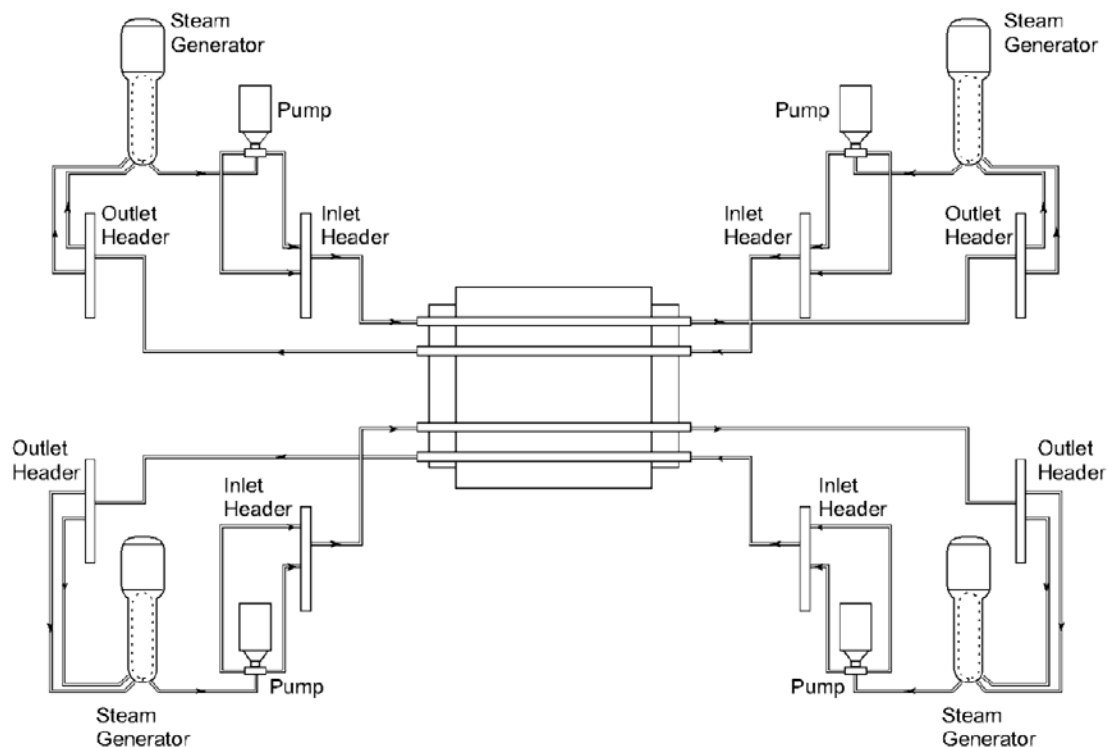

With the pressure-tube concept, on-power refuelling becomes possible, since, with an appropriate design, fuel channels can be “opened” individually and at full power to replace some of the fuel. On-power refuelling was therefore adopted for the CANDU design.

A fundamental principle in CANDU reactor design, and a regulatory requirement, is the separation of process systems – the systems for power production – from safety systems. The objective is to reduce the likelihood of common-cause events which could initiate an operating upset and impair the performance of safety systems in accident conditions. In addition to the requirement for the separation of process and safety systems, the systems which perform safety functions are divided into two groups. The two groups are physically separated so that, within the limits of design, no directional or localized common-cause event (such as a tornado) can disable more than one group.

Normal practice in CANDU systems is to triplicate the instrumentation and equipment associated with important process and special safety systems, such as the reactor regulating system or shutdown systems. The instrumentation wiring of triplicated shutdown systems is physically separated into three channels. Separation or distance requirements exist to keep each channel and each piece of redundant equipment away from its counterpart, so that a common-cause event (such as

electromagnetic interference, a fire or a flood) does not affect both pieces of redundant equipment simultaneously.

CANDU fuel channels are housed in a cylindrical calandria vessel containing the heavy water moderator, which is itself surrounded by a large shield tank filled with light water. These three components represent main sources of cooling and can act as barriers to accident progression. They can be defended by actions taken as part of severe accident management, another component of defence in depth in CANDU reactors.

CANDU reactors have the following major electrical power systems, listed in ascending order of reliability:

- **Class IV**, which supplies AC power to all essential and non-essential loads during normal plant operation: Class IV power is supplied from the reactor's own turbine generator and also from the electrical grid.
- **Class III**, which supplies AC power to the essential loads required to bring the plant to a safe shutdown state and maintain the reactor in a shutdown condition: Class III loads are normally supplied from Class IV but, in the event that Class IV power is lost, it is supplied by standby generators which are automatically started and loaded.
- **Class II**, which supplies uninterruptible AC power to the essential auxiliary services: Class II power is normally supplied from Class I (batteries) through inverters to ensure there is no interruption to Class II loads.
- **Class I**, which supplies uninterruptible DC power to the essential auxiliary services: Class I power is normally supplied from Class III power through rectifiers and is backed up by batteries to ensure uninterruptible supply to Class I loads.
- **Emergency power system (EPS)**, which supplies AC power to essential systems (known as group 2 systems), required for reactor safe shutdown and decay heat removal under conditions where all other power supplies (i.e., Class I to IV) are not available: The EPS is independent of the other power supplies.

The most challenging technical issues for severe accident management in CANDU reactors are hydrogen management; containment venting; and, where applicable, the response of the multi-unit, negative pressure containments. Relative to LWRs of comparable output, CANDU reactor cores contain a large mass of zirconium and its alloys, of the order of 50 Mg, used to fabricate the fuel elements, fuel bundles, pressure tubes and calandria tubes. Oxidation of a large fraction of zirconium inventory in a severe accident, should it occur, has the potential to result in significant concentrations of hydrogen in the containment atmosphere. For multi-unit stations, the actual concentrations would depend not only on how much oxidation takes place but also on how hydrogen is distributed throughout the reactor units, pressure relief duct, vacuum building and the fuelling machine duct (figure A.8). All multi-unit CANDU plants are currently equipped with hydrogen ignition systems. Some operators had either installed or were actively pursuing the provision of additional hydrogen mitigation by installing passive autocatalytic recombiners, (PARs) prior to the Fukushima Daiichi accident. In view of the Fukushima accident, the PARs installation across the CANDU fleet is expected to be expedited.

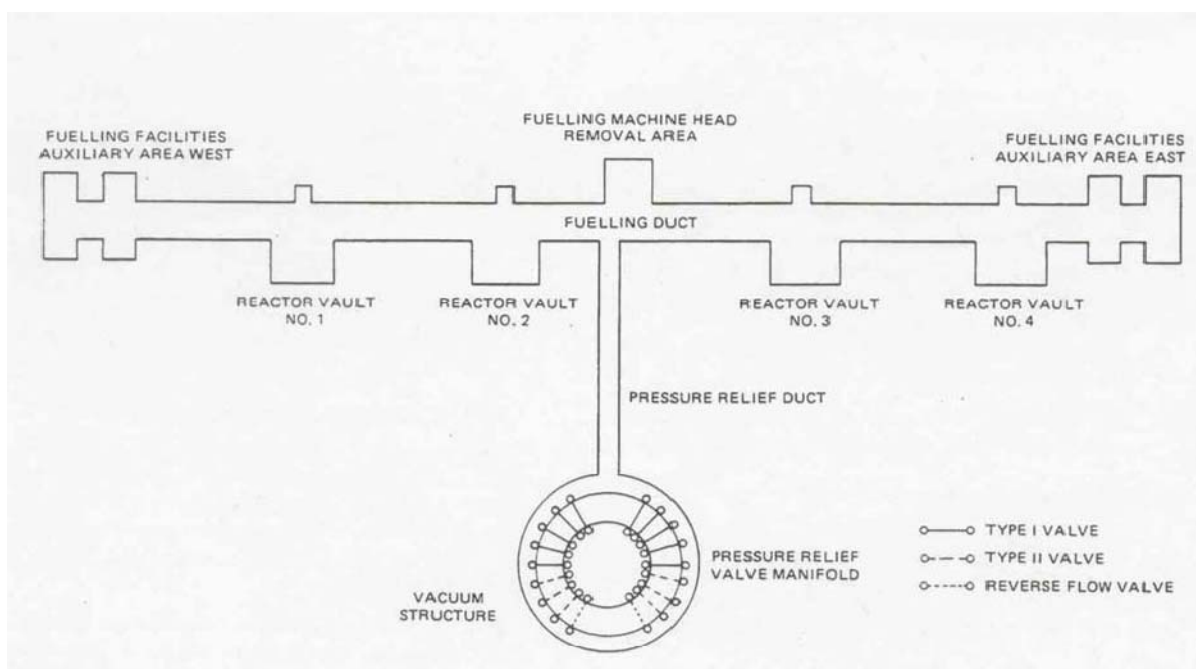
Figure A.8 Outline of a Multi-unit Containment Envelope

In a multi-unit station, all the reactor vaults are connected together by the fuelling machine duct and pressure relief duct. This shared containment volume is isolated from the vacuum building by pressure relief valves. During normal operation there is vacuum in the vacuum building and a slightly sub-atmospheric pressure in the ducts and reactor vaults. An accident, such as a loss-of-coolant accident, in one of the reactor vaults causes the pressure in the shared containment volume to rise. The pressure difference between the reactor vault and the vacuum building automatically opens the relief valves, connecting the reactor vaults and ducts to the vacuum building. Steam and gases released in the accident are swept into the vacuum building. In the vacuum building, the rise in pressure releases a large spray of cold water from a dousing tank in the vacuum building roof. The cold water condenses the steam and absorbs the energy released by the accident. The pressure in the reactor vaults, ducts and vacuum building remain below atmospheric pressure for many hours, ensuring there can be no leakage of radioactive material to the environment.

All multi-unit CANDU containments have an emergency filtered air discharge system (EFADS) which can be used to vent the containment atmosphere following an accident such as loss of coolant. The challenge facing this design in severe accidents is that EFADS were not designed to operate in severe accident conditions over prolonged periods of time or under elevated pressure. Their filters may be clogged by aerosols expected to be generated in large amounts in severe accidents. In addition, EFADS are active systems that require AC power to function. Prior to the Fukushima accident, the Point Lepreau station was undergoing refurbishment. As part of this refurbishment, the licensee had installed an additional, external containment filtered venting system, which enhances the plant's ability to respond to severe accidents. Some multi-unit stations had been considering the same type of design modification.

It should be recognized that every NPP design in the world has a set of challenges to contend with in mitigation of highly unlikely severe accidents. CANDU reactors have many positive features but also some areas where further improvement is possible. This report addresses possible enhancements arising from the review of the lessons learned from the Fukushima Daiichi accident.

The irradiated (or spent) nuclear fuel removed from CANDU reactors is stored under water in irradiated fuel bays (IFBs), equivalent to spent fuel pools in other reactor types. The water serves as a shield from radiation and also cools the used nuclear fuel. After about a day in the IFB, the used nuclear fuel generates less than 1 percent of the heat that it generated while in the core. This amount further decreases with time. The resulting cooling requirements are greatly reduced and, as a result, there are significant safety margins when the used nuclear fuel is in the IFB. After about 6–10 years in wet storage in the IFB, the used nuclear fuel can be safely transferred to dry storage in concrete canisters, containers or silos. All used nuclear fuel in Canada is currently held onsite in interim storage facilities, which are safe, secure and environmentally sound.

The IFBs are designed and sized to safely accommodate spent fuel produced at the site until it can be transferred to dry storage. The IFBs are the size of Olympic pools and about 10 metres deep. A typical CANDU reactor IFB is shown in figure A.9. The walls and floor are constructed of carbon-steel-reinforced concrete approximately 2 metres thick. Inner walls and floors are lined with a watertight liner consisting of stainless steel, a fibreglass-reinforced epoxy compound, or a combination of the two. The IFB structure is seismically qualified to maintain its safety function during and following a design-basis event. The IFBs have several designed safety systems to ensure cooling requirements are met.

The IFBs are located outside of the reactor buildings to prevent additional, cascading failures from events or accidents should they occur in the containment. It is important to note that, while CANDU IFBs are generally located at ground level, those at Japan’s Fukushima Daiichi site (Mark I type BWRs) are located at a higher elevation, as shown in figure 2.2. It thus follows that the BWR design makes spent fuel pools more vulnerable to seismic events and accidents originating in the reactor building.

Figure A.9 Typical CANDU Irradiated Fuel Bay

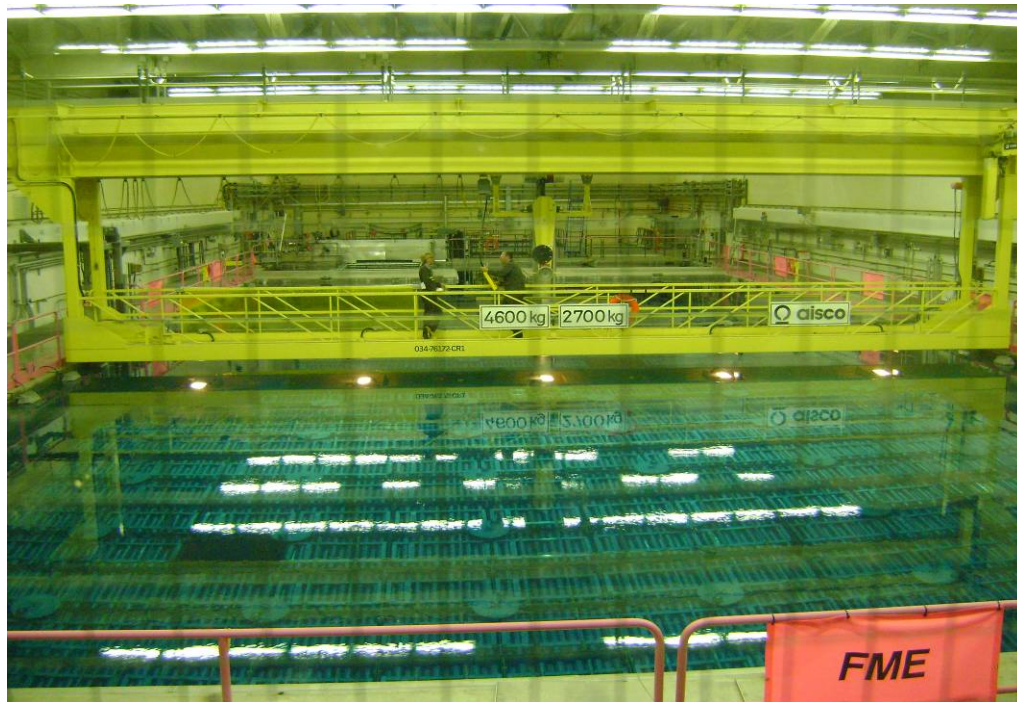

Appendix B Progression of a Loss of Heat Sink Accident

The focus of the evaluation of beyond-design-basis accidents is on a complete loss of heat sinks. This appendix provides a description of the various stages of the accident, identifying where the operator could intervene to terminate or slow down the accident progression in a CANDU reactor. It assumes progressive failure of all engineering and procedural safety features. As such, it is not a realistic accident, but is nevertheless instructive in exploring levels 1 to 4 of defence in depth.

This description of the event sequence is thought to be broadly correct, particularly in the early stages. The exact sequence, timing and consequences will vary between reactors. The description of the later stages is particularly uncertain.

B.1 Secondary boil-down

At the start of the accident, all main feedwater and main heat transport pumps are lost due to an assumed loss of electrical power. The reactor trips immediately on loss of circulation of primary coolant.

After the reactor trip, heat removal continues as the boilers still contain a lot of water. Conditions remain stable for up to 5.5 hours (the exact time depends on the station), until the boilers finally boil dry. Core cooling is adequate throughout this period.

Simple operator actions are also possible that will extend the period of secondary boil-down for several hours. Depressurizing the boilers (a simple control room action) allows gravity feed from the deaerator tank³⁹ into the boilers. Point Lepreau and Gentilly-2 also have the option of gravity feed from the dousing tank, which would extend the secondary boil-down period to about four days. Restoration of electrical power within the period of secondary boil-down would allow a complete recovery with no fuel damage.

B.2 Primary boil-down

After the boilers are dry, the primary coolant heats up and primary pressure rises. Relief valves open and water is discharged into the bleed condenser⁴⁰. Effectively, the primary water inventory is boiled away, just as the secondary side had boiled away earlier.

About 4 hours after boiler dryout, the bleed condenser relief valves open, discharging primary coolant into the containment. Restoration of electrical power before this time would allow a recovery with limited or no core damage.

Reduction of primary water inventory eventually leads to a loss of coolant circulation and fuel begins to heat up. The hot fuel heats the pressure tubes, one or two of which quickly fail, depressurizing the reactor into the moderator. The moderator pressure increases, breaking rupture disks at the top of the calandria vessel; a fraction of the moderator and primary coolant is discharged into the containment. In reactors with passive accumulators, following the depressurization of the primary heat transport system, emergency core cooling is injected which will cool the fuel for a while, but the accumulator water is soon depleted.

³⁹ The deaerator is a large tank of feedwater which removes dissolved or entrained air from feedwater. Its high elevation permits it to be used as a passive source of gravity feed, meaning that gravity moves the water down to the boiler.

⁴⁰ The degasser (or bleed) condenser is a vessel in the pressure and inventory control system. One of its main functions is to act as a buffer volume to accept steam and water discharged from the primary relief valves.

B.3 Moderator boil-down

After accumulator water is depleted, or immediately for reactors with pumped injection (Pickering A, B and Darlington), the intact pressure tubes will soften, become deformed and come into contact with the surrounding calandria tubes. This provides a path for heat from the core to be removed by the moderator. Without adding more water, the moderator can remove decay heat for a further 5.5 hours after boiler dry-out (the exact time depends on the station). Restoration of moderator cooling early in this period can prevent reactor meltdown. Bruce A units 1 and 2 already have the capability to provide make-up water to the moderator. Other stations are evaluating options to provide a make-up capability.

In the absence of make-up, the moderator continues to boil away. The level in the calandria vessel falls, progressively uncovering the fuel channels which then begin to overheat. The core debris from failed high elevation channels can overload and fail lower elevation channels and this can lead to the relocation of a substantial amount of high temperature debris into the remaining moderator water. Rapid generation of steam can lead to containment failure at this stage.

Substantial fuel overheating occurs and the reaction of zirconium in the fuel sheath with steam will generate hydrogen. Fission products and hydrogen are released into the containment.

B.4 Shield tank / calandria vault boil-down

After the moderator water is depleted, the core falls to the floor of the calandria vessel. The calandria vessel is surrounded by a water-filled tank called the shield tank or calandria vault, depending on the station. This water provides a further heat sink for the core debris. For some designs, the shield tank relief is incapable of relieving the volume of steam generated and the shield tank will fail shortly after boiling begins. This time is difficult to estimate. Reactors with a calandria vault can delay further damage until the calandria vault water is depleted. NB Power has installed a calandria vault make-up capability at the Point Lepreau facility which can delay calandria vault failure for four days, even if all earlier heat sinks were ineffective.

As core damage and fuel debris temperature increase, additional fission products are released to the containment.

B.5 Shield tank / calandria vault failure

After failure of the shield tank / calandria vault, the core debris falls to the concrete floor beneath. If the space is water filled, rapid generation of steam can lead to high pressure in the containment. In the absence of water, or after the water has boiled away, the molten core material begins to attack the concrete. Ablation (erosion) of concrete generates large quantities of heat and non-condensable gas, including hydrogen and carbon monoxide, which are flammable. The rate of generation of combustible gas is beyond the capability of passive autocatalytic recombiners, and hydrogen explosions cannot be precluded. It should be noted that the capacity of containment filtered venting systems is not adequate to control pressure. If containment has not already failed, it will fail due to overpressure or a hydrogen explosion at this stage. It is estimated that interaction between the core and concrete would cease before the reactor building basemat⁴¹ is penetrated.

⁴¹ The basemat is the thick concrete floor of the reactor building.

Appendix C CNSC Emergency Operations Centre Lessons Learned

This summary is based on the CNSC Reports *Fukushima Nuclear Emergency EOC After Action Report*, CNSC, published on August 16, 2011, and *Fukushima Nuclear Emergency EOC Improvement Plan*, CNSC, published on August 28, 2011.

C.1 Background

On the morning of March 11, 2011, the Canadian Nuclear Safety Commission (CNSC) became aware that natural disasters had adversely affected some of the nuclear power plants on the east coast of Japan. By midday, after consulting with senior management, the CNSC Emergency Operations Centre (EOC) was activated in accordance with the *CNSC Emergency Response Plan CAN – 2.1*. Staff from the CNSC assembled to form the CNSC Nuclear Emergency Organization (NEO) and worked to assess the situation in Japan and develop the strategy for the Canadian response.

Until April 4, for a total of 23 days, approximately 150 staff worked in the EOC on a 24/7 basis to monitor and assess the situation in Japan. CNSC specialists were able to provide expertise in the fields of reactor technology and radiation protection. The CNSC also reached out and cooperated with the nuclear regulators in the United States, United Kingdom and France to exchange the latest technical information.

Following the deactivation of the EOC and return to routine operations, the CNSC's Emergency Management Programs Division (EMPD) undertook a lessons-learned process to capture the important operational experience from the EOC activation and strengthen the CNSC Nuclear Emergency Management Program. The process was focused on the activation, operations and deactivation of the CNSC NEO, the EOC and the CNSC emergency response plans and procedures.

C.2 Methodology

The process of debriefing comprised four distinct activities encompassing all levels, positions and functions of the emergency management organization. The focus of these debriefing sessions was to identify what went well and what could have been done better.

C.2.1 Lessons Learned email account

During the EOC activation period, an EOC Lessons Learned email account was created on the CNSC network to enable NEO members to forward their comments and/or suggestions to identify the opportunities for improvement. Many comments were sent to this account.

C.2.2 NEO members debriefing session

On May 5, the EMPD held a debriefing session exclusively for the NEO members. The session was primarily focused on the EOC as a facility and the NEO structure as an organization. A discussion was also held on the specific roles and functional areas of the NEO. This session was attended by approximately 50 NEO members representing all positions and functions.

C.2.3 Executive and Emergency Director debriefing session

The members of the CNSC's Japan Executive Team (JET) and the directors general who performed the duty of Emergency Director during the EOC activation were debriefed on May 11. This debriefing session took into consideration the comments collected from the NEO members and the comments and suggestions received via the EOC Lessons Learned email account. The focus of this session was at a higher level (senior management) and on the products and tools required to improve the CNSC emergency response.

C.2.4 EMPD staff debriefing session

A debriefing session was also held for EMPD staff on May 20. The focus of this session was on the CNSC nuclear emergency response program, EOC organization, plans/procedures and the NEO structure.

C.3 Key observations

1. For an emergency occurring in a distant country, the activation of the CNSC NEO/EOC was timely and appropriate. The CNSC nuclear emergency management system worked as designed and planned. Overall the feedback received was positive, confirming the effectiveness and efficiency of the following.
2. The NEO concept of operations proved to be an effective as well as efficient organization. It proved to be flexible as it could be expanded or contracted as per the situation.
3. The EOC used the 3rd floor conference room at CNSC Headquarters in Ottawa as its centre of operations. This location proved to be an adequate facility for the NEO with, generally, the necessary tools and technology for staff to perform their functions. Availability of all meeting rooms on the 3rd floor ensured appropriate accommodation for all NEO functional teams.
4. The CNSC nuclear emergency response plans and procedures proved adequate and ensured proper linkages with our internal and external stakeholders.
5. The role and direction of an ad-hoc executive team (JET) was essential in providing guidance and strategic direction to the NEO.
6. The CNSC response to this emergency demonstrated an excellent coordination between all branches at the CNSC. Staff from Corporate Services Branch, Regulatory Affairs Branch, Technical Support Branch and Regulatory Operations Branch worked closely and effectively together. In particular, the coordination and integration between the Finance and Administration Directorate and Directorate of Security and Safeguards were well executed throughout the duration of the event, assuring the business continuity side of the emergency. The alternate site for the EOC was in a state of readiness and available at the CNSC's Telesat offices in Ottawa. This site would have been used had there been a need to relocate due to an incident at Headquarters.
7. Feedback obtained from the debriefing sessions indicated that on-the-job training of new NEO members during the three weeks activation was useful. Because the event was in a distant country and the NEO/EOC was activated for a prolonged period of time, a conscious decision was made to use this opportunity to train new NEO members. On-the-job training for the experienced NEO members proved to be good refresher training. The participation of many new NEO members is reflected in many of the comments sent to the EOC related to training.
8. No major changes to the EOC and its structure are required at this time. However, some technological improvements (hardware as well as software) are required in the EOC to enhance the emergency response capability and capacity.
9. The activation, operations and deactivation of the NEO in the EOC were successful. However, several opportunities for improvement were identified in the *Fukushima Nuclear Emergency EOC Improvement Plan*.

C.4 Conclusion

A comprehensive after-action process was undertaken to capture the lessons learned from the CNSC's EOC activation for the Fukushima event. A final report with suggested improvement actions was presented to the CNSC Management Committee on June 16. The CNSC Management Committee reviewed the submission and approved 39 cross-cutting EOC improvement actions that are now tracked in an EMPD-managed improvement plan.

Appendix D Correspondence of Report Recommendations to Detailed Findings

The table below shows the relationship between the CNSC Fukushima Task Force recommendations from section 10 and the detailed findings from sections 6 to 9.

10.1 Strengthening reactor defence in depth	
Recommendation 1	Review finding(s)
<p>1. Licensees should systematically verify the effectiveness of, and supplement where appropriate, the existing plant design capabilities in beyond-design-basis accident and severe accident conditions, including:</p> <p>a) overpressure response of the main systems and components</p>	<p>Section 6.3.8 (#5) Degasser (bleed) condenser relief valves have been tested to ensure that they are capable of providing sufficient relief flow for worst-case design-basis accidents. However, they have not been tested at extreme conditions that may arise in beyond-design-basis accidents. In these cases, relief valve capacity may not be adequate in a sustained loss of all heat sinks, reducing the time before pressure tubes fail. The CNSC previously evaluated this issue and accepted the current design, although the margin to failure was small.</p>
	<p>Section 6.3.8 (#6) Shield tank relief and calandria vault relief have not been verified to be adequate for beyond-design-basis accidents. A large inventory of water surrounds the core of a CANDU reactor – one of the strengths of its design. Nonetheless, if relief valves do not have sufficient capacity in a sustained loss of heat sinks, the shield tank could fail due to overpressure and much of the available water may be lost, leading to an earlier failure of the calandria vessel than would be the case if adequate relief was available.</p>
<p>b) containment performance to prevent unfiltered releases of radioactive products</p>	<p>Section 6.4.7 (#2) Plant design capabilities for severe accident management, such as containment venting, hydrogen mitigation, coolant make-up provisions, instrumentation, and the control areas have not been fully evaluated and documented. Such design capabilities would allow minimization of the consequences of a severe accident, should one occur.</p>
<p>c) control capabilities for hydrogen and other combustible gases:</p> <p>i) accelerate installation of the hydrogen management capability and sampling provisions</p>	<p>Section 6.3.8 (#1) Not all licensees have completed the installation of passive autocatalytic recombiners. Most licensees have taken action to accelerate the installation.</p>
<p>ii) include spent fuel bays and any other areas where hydrogen accumulation cannot be precluded</p>	<p>Section 6.3.8 (#10) The need for hydrogen mitigation in the irradiated fuel bay area has not been adequately evaluated.</p>
<p>d) make-up capabilities for the steam generators, primary heat transport system and connected systems, moderator, shield tank, and spent fuel bays</p>	<p>Section 6.3.8 (#9) The irradiated fuel bays (spent fuel pools) at most NPPs have temperature limits that lead to relatively short times (16 hours) for which a loss of cooling can be tolerated before the structural design temperature is reached. Above this temperature, an increasing risk of structural cracking could lead to leakage from the bay, thereby shortening the time to fuel uncovering. Additionally, with</p>

10.1 Strengthening reactor defence in depth	
	<p>a low water level, it may not be possible to perform manual actions in elevated radiation fields.</p> <p>Section 6.4.7 (#2) Plant design capabilities for severe accident management, such as containment venting, hydrogen mitigation, coolant make-up provisions, instrumentation, and the control areas have not been fully evaluated and documented. Such design capabilities would allow minimization of the consequences of a severe accident, should one occur.</p>
e) design requirements for the self-sufficiency of a plant site such as availability and survivability of equipment and instrumentation following a sustained loss of power and capacity to remove heat from a reactor	<p>Section 6.2.3 (#2) Safety analyses have demonstrated that equipment and procedures are adequate to ensure that, for all design-basis accidents where core cooling is lost when a shutdown reactor is hot and pressurized, the reactor can be taken to a stable state. However, analysis to show that the NPP can be taken to a cold, depressurized state is incomplete.</p>
	<p>Section 6.2.3 (#3) Safety analyses have not demonstrated that, for all design-basis accidents, equipment and procedures used to take the reactor to a cold, depressurized state can maintain that state for a prolonged period.</p>
	<p>Section 6.3.8 (#3) In the event of a loss of all normal, backup and emergency AC power, the guaranteed capability of Class I batteries to support all essential electrical equipment is 40 minutes (although it is recognized that some services will last much longer). This duration is short compared to other essential supply capabilities and gives little time to restore AC power. Once batteries are exhausted, most control and instrumentation functions are lost.</p>
	<p>Section 6.3.8 (#4) While key instrumentation is fully qualified for design-basis accidents, survivability in beyond-design-basis accident conditions has not always been demonstrated.</p>
	<p>Section 6.3.8 (#7) The minimum Class I/II equipment that is needed to mitigate beyond-design-basis accidents involving loss of all AC power has not been systematically identified.</p>
f) control facilities for personnel involved in management of the accident	<p>Section 6.4.7 (#2) Plant design capabilities for severe accident management, such as containment venting, hydrogen mitigation, coolant make-up provisions, instrumentation, and the control areas have not been fully evaluated and documented. Such design capabilities would allow minimization of the consequences of a severe accident, should one occur.</p>

10.1 Strengthening reactor defence in depth	
<p>g) emergency mitigating equipment and resources that could be stored offsite and brought onsite if needed</p>	<p>Section 6.4.7 (#4) Licensees' emergency response organizations do not have access to a regional warehouse that could make available offsite equipment and resources that may be needed in case of a severe accident. Availability of emergency equipment was shown to be crucial during the Fukushima event and could allow terminating a severe accident early enough to prevent any radioactive releases to the environment.</p>
Recommendation 2	Review finding(s)
<p>2. Licensees should conduct more comprehensive assessments of site-specific external hazards to demonstrate that:</p> <p>a) considerations of magnitudes of design-basis and beyond-design-basis external hazards are consistent with current best international practices</p>	<p>Section 6.1.3 (#1) The original magnitudes considered for the design-basis and beyond-design-basis assessments of external hazards were developed for the original licensing of the facilities. Although in general a lot of conservatism was included in the original designs, some design bases are not consistent with modern best practices.</p> <p>Section 6.1.3 (#3) External hazards screening and bounding analysis are in different states of development for each NPP. Consequently, analysis of all external hazards is not complete at all NPPs.</p>
<p>b) consequences of events triggered by external hazards are within applicable limits</p> <p>Such assessments should be updated periodically to reflect gained knowledge and modern requirements.</p>	<p>Section 6.1.3 (#2) The assessment for the design-basis and beyond-design-basis tornado hazard was found to be weak at some NPPs.</p> <p>Section 6.2.3 (#1) Implementation of a safety analysis framework based on RD-310, <i>Safety Analysis of Nuclear Power Plants</i>, is incomplete.</p> <p>Section 6.4.7 (#5) Severe accident analyses and assessments of external hazards are not systematically produced and periodically updated. This aspect of the plant safety case has not received much attention in the past and was shown to be important in understanding the site-specific challenges and possible progression of a severe accident.</p>
Recommendation 3	Review finding(s)
<p>3. Licensees should enhance their modelling capabilities and conduct systematic analyses of beyond-design-basis accidents to include analyses of:</p> <p>a) multi-unit events</p>	<p>Section 6.4.7 (#1) Current assessments do not adequately consider events affecting multiple reactors on the site, events at spent fuel bays, as well as events triggered by extreme external hazards. Having detailed assessments of the severe accident management procedural guidance and design capabilities to cater to beyond-design-basis and severe accidents were shown to be of high priority during the Fukushima event.</p>

10.1 Strengthening reactor defence in depth	
	<p>Section 6.4.7 (#3) The scope of analyses of severe accidents does not fully cover accidents triggered by extreme external events, multi-unit events, and spent fuel bay accidents. The modelling capabilities for multi-unit events are not fully adequate. Improvements would also give a better estimation of the source terms of radioactivity and combustible gases.</p> <p>Section 6.3.8 (#8) Modelling of severe accidents performed for multi-unit NPPs was based on a computer model that represents only a single unit. The modelling approach is accepted as adequately giving broadly representative results but would not be capable of calculating, for example, the effects of different times of core meltdown in the different units.</p>
b) accidents triggered by extreme external events	<p>Section 6.3.8 (#2) Results of studies of the duration of primary boiloff before pressure tube failure are not consistent. The progression of a sustained loss-of-heat-sinks event described by licensees is in broad agreement with the CNSC’s understanding. However, the CNSC Task Force assessment of the time available before pressure tube failure is shorter than that given by industry.</p> <p>Section 6.4.7 (#1) Current assessments do not adequately consider events affecting multiple reactors on the site, events at spent fuel bays, as well as events triggered by extreme external hazards. Having detailed assessments of the severe accident management procedural guidance and design capabilities to cater to beyond-design-basis and severe accidents were shown to be of high priority during the Fukushima event.</p>
c) spent fuel bay accidents	<p>Section 6.4.7 (#1) Current assessments do not adequately consider events affecting multiple reactors on the site, events at spent fuel bays, as well as events triggered by extreme external hazards. Having detailed assessments of the severe accident management procedural guidance and design capabilities to cater to beyond-design-basis and severe accidents were shown to be of high priority during the Fukushima event.</p>
The analyses should include estimation of releases, into the atmosphere and water, of fission products, aerosols and combustible gases.	

10.2 Enhancing emergency response		
Recommendation 4	Review finding(s)	
<p>4. Licensees should assess emergency plans to ensure emergency response organizations will be capable of responding effectively in a severe event and/or multi-unit accident, and conduct sufficiently challenging emergency exercises based on them.</p>	<p>Section 6.5.11 (#1) Emergency response organizations are capable of responding to single-unit, beyond-design-basis events. Evaluation and revision of emergency plans in regard to multi-unit accidents and severe external events, including an assessment of the minimum complement requirements have not been performed. As a result, it has not been conclusively demonstrated that emergency response organizations will be capable of responding effectively in a severe event and/or multi-unit accident.</p>	
	<p>Section 6.5.11 (#2) The performance of the emergency response organization under severe event and/or multi-unit accident conditions has not been challenged by designing and conducting exercises that are based on such conditions.</p>	
Recommendation 5	Review finding(s)	
<p>5. Licensees should review and update their emergency facilities and equipment, in particular:</p> <p>a) ensure operability of primary and backup emergency facilities and of all emergency response equipment that require electrical power and water</p>	<p>Section 6.5.11 (#4) Not all licensees' emergency facilities and equipment have backup power available in the event of a loss of external power. Backup power sources for primary and alternate emergency facilities, and all emergency response equipment that require electrical power to operate (e.g., electronic dosimeters, two-way radios), have not been systematically identified. The applicable emergency plans and procedures do not, in all cases, adequately document the requirements and limitations.</p>	
	<p>b) formalize all arrangements and agreements for external support and document these in the applicable emergency plans and procedures</p>	<p>Section 6.5.11 (#5) Arrangements and agreements for external support are not always formalized and not always documented in the applicable emergency plans and procedures.</p>
	<p>c) verify or develop tools to provide offsite authorities with an estimate of the amount of radioactive material that may be released and the dose consequences, including the installation of automated real-time station boundary radiation monitoring systems with appropriate backup power</p>	<p>Section 6.5.11 (#3) Automated real-time station boundary radiation monitoring systems with appropriate backup power and communications systems are seen as a best practice approach and allow critical data to be available rapidly. However, such systems are not available at all sites.</p> <p>Section 6.5.11 (#6) Hydro-Québec does not currently have source term estimation capability included in its dose modelling tools. NB Power does not currently have source term and dose modelling tools.</p>
Recommendation 6	Review finding(s)	
<p>6. Federal and provincial nuclear emergency planning authorities should undertake a review of their plans and supporting programs, such as:</p> <p>a) ensuring plan revision activities are expedited and making regular full-scale exercises a priority</p>	<p>Section 7.5 (#5) Federal and provincial nuclear emergency planning authorities have not yet undertaken a formal lessons-learned process to gain knowledge from offsite management of the Fukushima nuclear emergency and update plans accordingly.</p>	
	<p>Section 7.5 (#8)</p>	

10.2 Enhancing emergency response	
	<p>The Health Canada Federal Nuclear Emergency Plan (FNEP) has not been updated since 2002 and is not formally integrated with the Public Safety Canada Federal Emergency Response Plan (FERP). The FNEP and FERP integration has not been validated in a full-scale, NPP-focused exercise.</p> <p>Section 7.5 (#3) Federal and provincial nuclear emergency planning authorities are not making regularly planned full-scale NPP-focused exercises a priority. It was generally observed at the provincial and federal level that there has been a reduction in the frequency of full-scale NPP-focused exercises. Although all provincial and federal plans reviewed appear to be satisfactory, the implementation, and thus the capability to respond, has generally not been tested in an exercise for several years.</p>
	<p>Section 7.5 (#13) The Province of Quebec has not recently updated its nuclear emergency plan.</p> <p>Section 7.5 (#15) The Province of New Brunswick has not recently updated its nuclear emergency plan.</p>
b) establishing a formal, transparent, national-level oversight process for offsite nuclear emergency plans, programs and performance	<p>Section 7.5 (#4) Federal and provincial nuclear emergency planning authorities do not fully address recovery phase guidelines and procedures in their emergency plans, as they primarily address only preparedness and response.</p> <p>Section 7.5 (#6) There is no formal, transparent, national-level oversight process for offsite nuclear emergency plans, programs and performance. Whereas NPP licensees' onsite emergency plans, programs and performance are included in the CNSC regulatory oversight process, there is no similar system of oversight for offsite emergency plans.</p>
c) reviewing the planning basis of offsite arrangements in view of multi-unit accident scenarios	<p>Section 7.5 (#7) There is no established national guidance or standard for offsite nuclear emergency planning. Whereas NPP licensees are provided with CNSC guidance on emergency planning, there is no Canadian guidance for offsite nuclear emergency plans.</p> <p>Section 7.5 (#9) The Province of Ontario planning basis for the current nuclear emergency plans and offsite arrangements is a single-unit accident scenario and does not explicitly consider a multi-unit accident scenario.</p>
d) reviewing arrangements for protective action including resolving the issues pertaining to public alerting, validating the effectiveness of potassium iodide (KI) pill-stocking and distribution strategies and verifying, or developing the capability for predicting, offsite effects	<p>Section 7.5 (#10) There are ongoing public alerting issues in the 3 km zone around the Pickering NPP. Also, the new 10 km public alerting requirement has not been fully implemented.</p>

	<p>Section 7.5 (#11) The potassium iodide (KI) pills for residents of the planning zone in Ontario are stocked at local pharmacies in the Durham region or the reception centre in Kincardine. The effectiveness of this approach, as opposed to pre-distribution to all households, has not been confirmed.</p>
	<p>Section 7.5 (#12) There is no automated public alerting system around the Gently-2 NPP.</p>
	<p>Section 7.5 (#14) The Province of New Brunswick does not have the capability for predicting offsite effects.</p>

10.3 Improving regulatory framework and processes	
Recommendation 7	Review finding(s)
7. The CNSC should initiate a formal process to amend the <i>Class I Nuclear Facilities Regulations</i> to require NPP licensees to submit offsite emergency plans with an application to construct or operate a nuclear power plant.	<p>Section 7.5 (#1) The <i>Class I Nuclear Facilities Regulations</i> do not currently require submission of offsite emergency plans with an NPP operating licence application. Whereas an NPP licensee’s onsite emergency plans are submitted to the CNSC as part of the licence application and renewal process, there is no formal requirement for the offsite plans to be submitted to the CNSC.</p>
	<p>Section 8.7 (#1) The <i>Class I Nuclear Facilities Regulations</i> do not have explicit requirements for submission of offsite emergency plans.</p>
Recommendation 8	Review finding(s)
8. The CNSC should amend the <i>Radiation Protection Regulations</i> to be more consistent with the current international guidance and to describe in greater detail the regulatory requirements needed to address radiological hazards during the various phases of an emergency.	<p>Section 8.7 (#2) The <i>Radiation Protection Regulations</i> are not fully consistent with international guidance and do not fully describe the regulatory requirements needed to address radiological hazards during the various phases of an emergency.</p>
Recommendation 9	Review finding(s)
9. The CNSC should update the regulatory document framework through:	<p>Section 8.7 (#6) The three-year regulatory framework plan does not currently accommodate the CNSC Task Force review findings.</p>
a) updating selected design-basis and beyond-design-basis requirements and expectations, including those for:	
i) external hazards and the associated methodologies for assessment of magnitudes	<p>Section 8.7 (#7) A small number of regulatory documents (RDs) or guidance documents (GDs) are lacking requirements or guidance needed to address the lessons learned.</p>
	<p>Section 8.7 (#8) The lessons learned are not yet fully considered for the next revision of other NPP-related RDs or GDs.</p>

10.3 Improving regulatory framework and processes	
	<p>Section 8.7 (#9) The lessons learned are not yet fully considered as part of the preparation of new RDs or GDs.</p>
	<p>Section 9 (#8) The CNSC has no requirements for the analysis of multi-unit accidents, particularly those that could arise from common-cause events.</p>
	<p>Section 6.1.3 (#4) The requirements and expectations for defining magnitudes to be used for design-basis and beyond-design-basis hazards have not been reviewed since original NPP licensing. The methodologies used to establish the criteria for these hazards are not consistent with modern best practices.</p>
	<p>Section 9 (#6) The CNSC has not documented an overall, systematic approach to the evaluation of all types of external events that could occur in Canada. A systematic approach would encompass both design-basis events and beyond-design-basis events.</p>
	<p>Section 9 (#7) The Fukushima event highlighted the need for margins to cliff-edges to be understood, particularly when exceeding such cliff-edges may have catastrophic consequences. CNSC currently has no explicit requirements for the assessment of such margins for new nuclear power plants.</p>
	<p>Section 9 (#15) The CNSC does not have a full set of requirements for plant and site layout that would facilitate protection against external hazards.</p>
ii) probabilistic safety goals	<p>Section 9 (#1) The safety goals in RD-337, <i>Design of New Nuclear Power Plants</i>, are based on single-unit events. Site-based safety goals or other safety criteria that take into account the site characteristics (including population distribution) and the possibility of multiple-unit accidents are not explicitly considered.</p>
	<p>Section 9 (#3) Whereas the safety goals are likely adequate for the design of individual units, these may not be sufficient for a robust demonstration of the offsite response. A separate, more demanding, release value would result in more challenging evaluations of the offsite response.</p>
iii) complementary design features for both severe accident prevention and mitigation	<p>Section 9 (#2) Although RD-337 already has explicit requirements for the design of complementary design features consistent with international practice, these may not be complete. In addition, there are no explicit requirements for such features for irradiated fuel bays, including combustible gas management.</p>

10.3 Improving regulatory framework and processes	
	<p>Section 9 (#10) The CNSC does not have explicit requirements for complementary design features that could be called upon to protect the containment. One such feature is filtered containment venting.</p>
	<p>Section 9 (#14) The CNSC does not have explicit requirements for the emergency heat removal system for beyond-design-basis conditions, including the mission time during which it must be available.</p>
iv) passive safety features	<p>Section 9 (#4) The Fukushima event highlighted the difficulties that can arise when an NPP relies solely on active engineered systems. The need for specific regulatory requirements for passive safety features has not been assessed.</p>
v) fuel transfer and storage	<p>Section 9 (#5) The requirements in RD-337 for the design, placement and engineering robustness of irradiated fuel bays is not complete for the entire spectrum of beyond-design-basis scenarios.</p>
vi) design features that would facilitate accident management	<p>Section 9 (#9) The CNSC requirements for the design that would facilitate accident management and severe accident management are incomplete. For example, there are no explicit provisions for the use of portable equipment and the availability of connections for temporary supplies of electrical power and water.</p>
	<p>Section 9 (#11) The CNSC does not have comprehensive requirements for minimum times before significant operator interventions are required. Such requirements would be commensurate with the type of intervention, for example, the need for offsite portable equipment to be brought onsite.</p>
	<p>Section 9 (#12) Previous accidents have identified the importance of operators having access to reliable plant information. The CNSC currently does not have explicit requirements for “hardened” plant monitoring features and instrumentation that would function reliably under severe accident conditions, and for the control room equipment expected to be available.</p>
	<p>Section 9 (#13) The CNSC does not have design requirements for automated real-time onsite field radiation monitoring.</p>

10.3 Improving regulatory framework and processes	
b) developing a dedicated regulatory document on accident management	<p>Section 6.4.7 (#7) Relevant sections in the existing and planned regulatory documents, such as G-306, <i>Severe Accident Management Programs for Nuclear Reactors</i>; RD-310, <i>Safety Analysis for Nuclear Power Plants</i>; and RD-337, <i>Design of New Nuclear Power Plants</i>, have not been re-evaluated and revised to account for the lessons learned following the Fukushima accident. There is currently no regulatory document giving specific requirements for accident management.</p>
	<p>Section 9 (#16) CNSC requirements for operational limits and conditions do not integrate into one structure the command and control needs during normal operation, the emergency operating procedures and severe accident management guidelines. Furthermore, there is currently no requirement for further guidance similar to the “extensive damage mitigation guidelines” used in the United States, which can be used when extensive damage has occurred across a site.</p>
c) strengthening the suite of emergency preparedness regulatory documents	<p>Section 6.5.11 (#7) The suite of emergency preparedness regulatory requirement documents, currently comprising guidance document G-225, <i>Emergency Planning at Class I Nuclear Facilities and Uranium Mines and Mills</i>, and regulatory document RD-353, <i>Testing the Implementation of Emergency Measures</i>, are lacking detailed and specific requirements needed to strengthen and standardize emergency preparedness and response in Canada.</p>
d) reviewing applicable Canadian Standards Association standards	<p>Section 8.7 (#10) Canadian Standards Association standards that apply to NPPs have not been reviewed by the CNSC staff as a result of lessons learned.</p>
Recommendation 10	Review finding(s)
10. The CNSC should amend all power reactor operating licences to include specific licence conditions, requiring implementation of accident management provisions, severe accident management and public information.	<p>Section 6.4.7 (#6) Current power reactor operating licences do not have specific licence conditions requiring implementation of accident management provisions, including those for severe accidents.</p>
	<p>Section 8.7 (#4) Existing licence conditions in power reactor operating licences do not explicitly address accident management, severe accident management and public information.</p>
	<p>Section 8.7 (#5) RD-99.3, <i>Requirements for Public Information and Disclosure</i> and its guide, GD-99.3, <i>Guide to the Requirements for Public Information and Disclosure</i>, have not been approved for publication, leaving a potential gap in regulatory requirements and guidance for licensees’ public information programs.</p>

10.3 Improving regulatory framework and processes	
	Section 8.7 (#11) Licence condition handbooks are lacking requirements and guidance needed to address lessons learned.
Recommendation 11	Review finding(s)
11. The CNSC should further enhance the regulatory oversight of nuclear power plants through implementation of a periodic safety review process.	Section 8.7(#3) Canada does not have a formal periodic safety review process. As demonstrated by international practice, regulatory oversight of nuclear power plants may be further enhanced through implementation of a periodic safety review process.
Recommendation 12	Review finding(s)
12. The CNSC should review memoranda of understanding with regulatory counterparts in countries with CANDU reactors to outline what support, if any, they would require from the CNSC during a nuclear emergency.	Section 7.5 (#2) The memoranda of understanding with regulatory counterparts in countries with CANDU reactors have not been reviewed to identify what support, if any, they would require from the CNSC during a nuclear emergency.
Recommendation 13	Review finding(s)
13. The CNSC should enhance cooperation with other nuclear regulators in addressing the lessons learned from the Fukushima accident and thus further strengthen the capability to respond efficiently to any nuclear emergency.	Section 7.5 (#2) The memoranda of understanding with regulatory counterparts in countries with CANDU reactors have not been reviewed to identify what support, if any, they would require from the CNSC during a nuclear emergency.